

The Executive Director

**DECISION No EX-23-2 on the adoption of the Guidelines for Examination of European Union Trade Marks and Registered Community Designs at the European Union Intellectual Property Office**

The Executive Director of the European Union Intellectual Property Office (the Office),

Having regard to Regulation (EU) 2017/1001 of the European Parliament and of the Council on the European Union trade mark (EUTMR) in particular Article 157(4)(a) thereof, and to Council Regulation (EC) No 6/2002 of 12 December 2001 on Community designs (CDR), in particular Article 100 thereof,

After consultation with the Management Board in accordance with Article 153(1)(l) EUTMR and Article 101(b) CDR,

HAS ADOPTED THE FOLLOWING DECISION:

*Article 1*

**Adoption of the Guidelines**

The following 'Guidelines for Examination of European Union Trade Marks and Registered Community Designs at the European Union Intellectual Property Office' (Guidelines for Examination), which are annexed to this decision, are hereby adopted:

Introduction

Editor's Note and General Introduction

**A) EUROPEAN UNION TRADE MARKS**

- Part A: General rules
- Section 1: Means of communication, time limits
  - Section 2: General principles to be respected in the proceedings
  - Section 3: Payment of fees, costs and charges
  - Section 4: Language of proceedings
  - Section 5: Parties to the proceedings and professional representation
  - Section 6: Revocation of decisions, cancellation of entries in the register and correction of errors
  - Section 7: Revision
  - Section 8: *Restitutio in Integrum*
  - Section 9: Enlargement

- Part B: Examination
- Section 1: Proceedings
  - Section 2: Formalities
  - Section 3: Classification

Section 4: Absolute grounds for refusal

- Part C: Opposition
- Section 0: Introduction
  - Section 1: Opposition proceedings
  - Section 2: Double identity and likelihood of confusion
  - Section 3: Unauthorised filing by agents of the TM proprietor (Article 8(3) EUTMR)
  - Section 4: Non-registered trade marks and other signs used in the course of trade (Article 8(4) EUTMR)
  - Section 5: Trade marks with reputation (Article 8(5) EUTMR)
  - Section 6: Geographical indications (Article 8(6) EUTMR)
  - Section 7: Proof of use
- Part D: Cancellation
- Section 1: Cancellation proceedings
  - Section 2: Substantive provisions
- Part E: Register operations
- Section 1: Changes in a registration
  - Section 2: Conversion
  - Section 3: EUTMs and RCDs as objects of property
  - Section 4: Renewal
  - Section 5: Inspection of files
  - Section 6: Other entries in the register
- Part M: International marks

## **B) REGISTERED COMMUNITY DESIGNS**

Examination of applications for registered Community designs

Examination of design invalidity applications

### *Article 2* **Repeal**

Decision No EX-22-1 of the Executive Director of the Office of 22 March 2022, concerning adoption of the Guidelines for Examination, is repealed as from the date of entry into force of the present decision.

Article 3  
**Entry into force**

This decision will be published in the Official Journal of the Office and will enter into force on 31 March 2023.

Done at Alicante, 24 March 2023.



Christian Archambeau  
Executive Director

**GUIDELINES FOR EXAMINATION**

**EUROPEAN UNION**  
**INTELLECTUAL PROPERTY OFFICE**  
**(EUIPO)**

- ***1 Introduction***
- ***Editor's note and general introduction***
- ***Part A General rules***
- ***Part B Examination***
- ***Part C Opposition***
- ***Part D Cancellation***
- ***Part E Register operations***
- ***Part M International marks***



## List of Figures

Figure 1: .....	228
Figure 2: .....	462
Figure 3: .....	533

## List of Tables

Table 1: Applications refused.....	352
Table 2: Examples of non-deceptive trade marks .....	563
Table 3: Example of deceptive trade marks .....	565

---

**GUIDELINES FOR EXAMINATION**

**EUROPEAN UNION**  
**INTELLECTUAL PROPERTY OFFICE**  
**(EUIPO)**

***1 Introduction***

---

The Office's current trade mark and design practice is reflected in a series of Guidelines that are intended to be of practical use both to Office staff in charge of the various procedures and to users of the Office's services.

The Office issues a revision of the Guidelines on a yearly basis. See the Guidelines, [Editor's Note and General Introduction, paragraph 3](#) , for further information about the revision process of the Office's Guidelines.

The Office's Guidelines are the main point of reference for users of the European Union trade mark system and the Community design system, and for professional advisers who want to ensure they have the latest information on our examination practices.

They have been drawn up to reflect our Office practice in the most frequent scenarios. They contain general instructions, which have to be adapted to the particularities of a case.

Therefore, the Office's Guidelines are not legal acts, but self-imposed rules of conduct adopted by an administrative decision.

The Guidelines on EU trade marks and the Guidelines on registered Community designs that are currently in force were adopted by the Executive Director on 24/03/2023 (Decision No EX-23-2), and entered into force on 31/03/2023.

The Office's Guidelines can be accessed in the five working languages of the Office (English, French, German, Italian and Spanish), through either a clean or a track-changed version. In the online version of the Guidelines, the track-changed version is visible via the 'show modification' function, which highlights the changes made compared to the previously adopted edition of the Guidelines.

Track-changed versions of new editions of the Office's Guidelines will also be translated and made available online in the other eighteen EU languages after they became available in the five working languages of the Office.

For previous editions of the Guidelines, please visit the [Repository](#).

---

**GUIDELINES FOR EXAMINATION**

**EUROPEAN UNION**  
**INTELLECTUAL PROPERTY OFFICE**  
**(EUIPO)**

***Editor's note and general introduction***

---

## Table of Contents

<b>1 Subject Matter.....</b>	<b>8</b>
<b>2 Objective of the Guidelines.....</b>	<b>8</b>
<b>3 Guidelines Revision Process.....</b>	<b>8</b>
<b>4 Structure of the Guidelines.....</b>	<b>10</b>

# 1 Subject Matter

The European Union Intellectual Property Office (EUIPO or the Office), established in Alicante, is responsible for the registration of European Union trade marks (EUTM) and registered Community designs (RCD) under [Regulation \(EU\) 2017/1001](#) of the European Parliament and of the Council of 14 June 2017 and [Council Regulation No 6/02](#) of 12 December 2001. These registrations provide uniform trade mark and design protection throughout the European Union.

The Office deals with registration procedures (including the examination of applications for absolute grounds for refusal and, where an opposition has been raised regarding an EUTM application, for relative grounds for refusal) accordingly, maintains the public registers of these rights and decides on applications for those rights, once registered, to be declared invalid. The Office's Guidelines cover practice in all of these areas.

## 2 Objective of the Guidelines

The Guidelines on EUTMs and the Guidelines on RCDs exist to improve the coherence, predictability and quality of Office decisions. The Guidelines are designed to bring together, systematically, the principles of practice derived from the jurisprudence of the European Court of Justice, the case-law of the Office's Boards of Appeal, the decisions of the Office's Operations Department and the outcomes of the Office's convergence programmes with EU IP offices.

As case-law evolves, so the Guidelines also evolve. They are adapted to reflect developments in Office practice on a yearly basis by means of an ongoing revision exercise (see [paragraph 3](#) below).

## 3 Guidelines Revision Process

As the sole source of reference on Office practice with regard to EUTMs and RCDs, the current Guidelines are available in the five Office languages. Additionally, the Office translates the Guidelines into the remaining official EU languages on a regular basis. They are revised by the Office's cross-departmental 'Knowledge Circles' in a cyclical and open process: 'cyclical' because practice is updated on a yearly basis by looking at the case-law of the preceding year and taking into account the operational needs and outcomes of convergence initiatives, and 'open' because external stakeholders are involved in defining that practice.

Involving national offices and user associations not only benefits the quality of the Guidelines, but also facilitates convergence, that is, the process of exploring common ground on issues where there may be diverging practices. Making the Guidelines

available in all EU languages will raise awareness of Office practice among Member States and users and make differences in practice easier to identify.

The process involves the following phases:

1. Preparation of the draft Guidelines by the Office

During this phase, the draft Guidelines are produced by the Office's Knowledge Circles. The three steps of this phase — analysis, drafting and discussion — must be completed in a timely manner. Analysis involves the Knowledge Circles extracting trends from the preceding year's case-law, studying the conclusions of the convergence projects and taking into consideration the comments received in previous years from the Office's users and stakeholders. As the next step, the Knowledge Circles draft the Guidelines. Finally, the texts are discussed within the Knowledge Circles, where representatives of the Office's various units and departments are represented.

2. Consultation of stakeholders

Once the drafts have been prepared, they are sent simultaneously for consultation to the external stakeholders, national offices and user associations, and internal stakeholders. During a period of at least 3 calendar months, stakeholders have the opportunity to study the drafts and submit their comments and suggestions. At the end of the consultation phase, the Knowledge Circles process the feedback received and implement them into the drafts. The Knowledge Circles can choose to accept or reject a comment, take it on board for the next revision cycle, or mark it as out of scope. A list of outcomes is published annually on the Office's website, containing the outcome of each comment received.

3. Adoption of the Guidelines

In this phase, the draft Guidelines are sent for translation into the Office languages. After consulting the MB in accordance with [Article 153\(1\)\(l\) EUTMR](#) and Article 101(b) CDR, the Executive Director adopts the updated Guidelines. The versions in the five Office languages together make up the official text, which is intended to be published in the first quarter of each year. In the event of discrepancies between different language versions, the text in the drafting language (English) will prevail. On a regular basis, the Guidelines will be translated into the remaining official languages of the European Union. These additional translations will be published on the Office's website, and external stakeholders, whether national offices or user associations, will be free to submit feedback on their quality; any linguistic amendments made as a result of this informal feedback will be incorporated into the texts without any formal procedure.

4. Fast-track procedure

In certain circumstances (e.g., a Court of Justice judgment that has immediate impact on Office practice) the Office can amend the Guidelines in the fast-track procedure outside of the normal time frame outlined above. However, this procedure is the exception to the norm.



## 4 Structure of the Guidelines

The items dealt with in the Guidelines are set out below.

[Introduction](#)

[Editor's Note and General Introduction](#)

### **EUROPEAN UNION TRADE MARKS**

[Part A: General Rules](#)

[Section 1: Means of Communication, Time Limits](#)

[Section 2: General Principles to be Respected in the Proceedings](#)

[Section 3: Payment of Fees, Costs and Charges](#)

[Section 4: Language of Proceedings](#)

[Section 5: Parties to the Proceedings and Professional Representation](#)

[Section 6: Revocation of Decisions, Cancellation of Entries in the Register and Correction of Errors](#)

[Section 7: Revision](#)

[Section 8: \*Restitutio in Integrum\*](#)

[Section 9: Enlargement](#)

[Part B: Examination](#)

[Section 1: Proceedings](#)

[Section 2: Formalities](#)

[Section 3: Classification](#)

[Section 4: Absolute Grounds for Refusal](#)

[Chapter 1: General Principles](#)

[Chapter 2: EUTM Definition \(Article 7\(1\)\(a\) EUTMR\)](#)

[Chapter 3: Non-Distinctive Trade Marks \(Article 7\(1\)\(b\) EUTMR\)](#)

[Chapter 4: Descriptive Trade Marks \(Article 7\(1\)\(c\) EUTMR\)](#)

[Chapter 5: Customary Signs or Indications \(Article 7\(1\)\(d\) EUTMR\)](#)

[Chapter 6: Shapes or Other Characteristics that Result from the Nature of the Goods, are Necessary to Obtain a Technical Result or give Substantial Value to the Goods \(Article 7\(1\)\(e\) EUTMR\)](#)

[Chapter 7: Trade Marks Contrary to Public Policy or Acceptable Principles of Morality \(Article 7\(1\)\(f\) EUTMR\)](#)

[Chapter 8: Deceptive Trade Marks \(Article 7\(1\)\(g\) EUTMR\)](#)

[Chapter 9: Trade Marks in Conflict with Flags and Other Symbols \(Article 7\(1\)\(h\) and \(i\) EUTMR\)](#)

[Chapter 10: Trade Marks in Conflict with Geographical Indications \(Article 7\(1\)\(j\) EUTMR\)](#)

[Chapter 11: Trade Marks in Conflict with Traditional Terms for Wines \(Article 7\(1\)\(k\) EUTMR\)](#)

[Chapter 12: Trade Marks in Conflict with Traditional Specialities Guaranteed \(Article 7\(1\)\(l\) EUTMR\)](#)

[Chapter 13: Trade Marks in Conflict with Earlier Plant Variety Denominations \(Article 7\(1\)\(m\) EUTMR\)](#)

[Chapter 14: Acquired Distinctiveness Through Use \(Article 7\(3\) EUTMR\)](#)

[Chapter 15: European Union Collective Marks](#)

[Chapter 16: European Union Certification Marks](#)

[Part C: Opposition](#)

[Section 0: Introduction](#)

[Section 1: Opposition Proceedings](#)

[Section 2: Double Identity and Likelihood of Confusion](#)

[Chapter 1: General Principles](#)

[Chapter 2: Comparison of Goods and Services](#)

[Chapter 3: Relevant Public and Degree of Attention](#)

[Chapter 4: Comparison of Signs](#)

[Chapter 5: Distinctiveness of the Earlier Mark](#)

[Chapter 6: Other Factors](#)

[Chapter 7: Global Assessment](#)

[Section 3: Unauthorised Filing by Agents of the TM Proprietor \(Article 8\(3\) EUTMR\)](#)

[Section 4: Non-registered trade marks and other signs used in the course of trade \(Article 8\(4\) EUTMR\)](#)

[Section 5: Trade Marks with Reputation \(Article 8\(5\) EUTMR\)](#)

[Section 6: Geographical Indications \(Article 8\(6\) EUTMR\)](#)

[Section 7: Proof of use](#)

[Part D: Cancellation](#)

[Section 1: Cancellation Proceedings](#)

[Section 2: Substantive Provisions](#)

[Part E: Register Operations](#)

[Section 1: Changes in a Registration](#)

[Section 2: Conversion](#)

[Section 3: EUTMs and RCDs as Objects of Property](#)

[Chapter 1: Transfer](#)

[Chapter 2: Licences, rights in rem, levies of execution, insolvency proceedings, entitlement proceedings or similar proceedings](#)

[Section 4: Renewal](#)

[Section 5: Inspection of Files](#)

[Section 6: Other Entries in the Register](#)

[Chapter 1: Counterclaims](#)

[Part M: International Marks](#)

## **REGISTERED COMMUNITY DESIGNS**

[Examination of Applications for Registered Community Designs](#)

[Examination of Design Invalidation Applications](#)

---

**GUIDELINES FOR EXAMINATION**

**EUROPEAN UNION**  
**INTELLECTUAL PROPERTY OFFICE**  
**(EUIPO)**

***Part A***

***General rules***

---

## Table of Contents

<b>Section 1 Means of communication, time limits.....</b>	<b>15</b>
<b>Section 2 General principles to be respected in the proceedings.....</b>	<b>36</b>
<b>Section 3 Payment of fees, costs and charges.....</b>	<b>51</b>
<b>Section 4 Language of proceedings.....</b>	<b>69</b>
<b>Section 5 Parties to the Proceedings and Professional representation.....</b>	<b>76</b>
<b>Section 6 Revocation of decisions, cancellation of entries in the register and correction of errors.....</b>	<b>140</b>
<b>Section 7 Revision.....</b>	<b>151</b>
<b>Section 8 Restitutio in integrum.....</b>	<b>156</b>
<b>Section 9 Enlargement.....</b>	<b>171</b>

**GUIDELINES FOR EXAMINATION**

**EUROPEAN UNION**  
**INTELLECTUAL PROPERTY OFFICE**  
**(EUIPO)**

***Part A***

***General rules***

***Section 1***

***Means of communication, time limits***

## Table of Contents

<b>1 Introduction.....</b>	<b>17</b>
<b>2 Procedures for Filing and for Communication with the Office.....</b>	<b>17</b>
<b>3 Notification and Communication of Documents.....</b>	<b>18</b>
<b>3.1 Communications to the Office in writing or by other means.....</b>	<b>19</b>
3.1.1 Via the User Area (electronic means).....	19
3.1.2 By post or courier service.....	21
3.1.3 Annexes to communications.....	21
3.1.4 Data carriers.....	22
3.1.5 Signature.....	23
3.1.6 Confidentiality.....	24
3.1.7 Withdrawal of communications.....	24
3.1.8 References made to documents or items of evidence in other proceedings.....	25
<b>3.2 Notification by the Office.....</b>	<b>26</b>
3.2.1 Notification by electronic means.....	27
3.2.2 Notification by post or courier.....	27
3.2.3 Public notification by public notice.....	28
<b>4 Time Limits Specified by the Office.....</b>	<b>28</b>
<b>4.1 Length of the time limits specified by the Office.....</b>	<b>29</b>
<b>4.2 Expiry of time limits.....</b>	<b>29</b>
<b>4.3 Extension of time limits.....</b>	<b>30</b>
<b>4.4 Continuation of proceedings.....</b>	<b>31</b>
<b>4.5 <i>Restitutio in integrum</i>.....</b>	<b>35</b>

## 1 Introduction

This part of the Guidelines includes those provisions that are common to all proceedings before the Office in trade mark and design matters, except appeals.

In the interests of efficiency and in order to prevent parties encountering different practices, the Office applies procedural rules consistently.

Proceedings before the Office can be classified into two broad types: **ex parte** proceedings, which involve only one party, or **inter partes** proceedings, in which two or more parties are in conflict.

The first category comprises, in particular, applications for registration or renewal of a European Union trade mark (EUTM) or a registered Community design (RCD), transfer-related entries in the Register, licences, levy of execution or bankruptcy, insolvency proceedings, priority/seniority claims and conversion proceedings.

The second category includes opposition and cancellation proceedings (revocation or declaration of invalidity of a registered EUTM or an RCD).

## 2 Procedures for Filing and for Communication with the Office

[Article 30 EUTMR](#)

Articles [63](#) and [65](#) EUTMDR

Article 35 CDR

Articles 65 and 68 CDIR

Decision No [EX-18-5](#) of the Executive Director of the Office of 3 September 2018 concerning the hours the Office is open to receive submissions by personal delivery relating to Registered Community Designs

Communications addressed to the Office can be submitted by electronic means, post or courier in proceedings relating to European Union trade marks and in addition by personal delivery in proceedings relating to Community designs. Notifications issued by the Office can be made by electronic means, post, courier services or public notification.

An application for an EUTM must be filed directly with the Office.

An application for an RCD may be filed directly with the Office, or through a central industrial property office of a Member State or the Benelux Office for Intellectual Property.

E-filing is a recommended means of filing, to the extent that the system gives guidance to the applicant, thus reducing the number of potential deficiencies and speeding up



the examination procedure. EUTMs filed through the Office's e-filing system are subject to a reduced fee. The Office also offers the possibility of an accelerated procedure known as Fast Track (for more details, please check the [Office's website](#)).

In the event of opting for filing by other means, the Office makes various forms available to the public, in all the official languages of the EU. With one exception, their use is not mandatory but strongly recommended. The exception is when filing an international application or subsequent designation under the Madrid Protocol, for which either the World Intellectual Property Organization's (WIPO) MM 2 or MM 4 form, or the Office's EM 2 or EM 4 form must be used.

### 3 Notification and Communication of Documents

The EUTMDR and the CDIR distinguish between documents originating from the parties and addressed to the Office and notifications issued by the Office.

A document's date of notification or communication is the date on which that document, is **received or is deemed to be received** by the addressee (including the Office) (30/01/2014, [C-324/13 P](#) , Patrizia Rocha, EU:C:2014:60, § 43). Exactly when receipt is deemed to have taken place will depend on the method of notification or communication.

Any notification addressed to the representative will have the same effect as if it had been addressed to the person represented ( [Article 60\(3\) EUTMDR](#) and Article 53 CDIR). Any communication addressed to the Office by a representative will be considered to have originated from the person he or she represents ( [Article 66 EUTMDR](#) and Article 63 CDIR).

If a professional representative has been duly appointed, the Office will send all notifications solely to the representative (12/07/2012, [T-279/09](#) , 100% Capri, EU:T:2012:367; 25/04/2021, [T-326/11](#) , BrainLAB, EU:T:2012:202). 'Duly appointed' means that the representative is entitled to act as such and has been properly appointed, and that no general obstacle exists to preclude representation by that person, such as illicit representation of both parties in *inter partes* proceedings. Filing an authorisation is not required in order to receive Office notifications.

For further details see [the Guidelines, Part A, General Rules, Section 5, Parties to the Proceedings and Professional Representation](#) .

### 3.1 Communications to the Office in writing or by other means

[Article 98\(3\) EUTMR](#)

[Article 100 EUTMR](#)

[Article 55\(2\), \(3\) and \(4\) EUTMDR](#), and Articles [63](#) and [64](#) EUTMDR

Articles 65 to 67 CDIR

Decision No [EX-20-9](#) of the Executive Director of the Office of 3 November 2020 on communication by electronic means

Decision [No EX-22-7](#) of the Executive Director of the Office of 29 November 2022 on technical specifications for annexes submitted on data carriers

Fax is expressly identified as a means of communication in all procedures relating to Community designs in Article 47(2)(d) CDIR and Article 51 CDIR, however, pursuant to Article 2 of Decision of the Executive Director No [20-9](#) on communication by electronic means, due to technical limitations and malfunctions affecting the reliability and preventing the uninterrupted functioning of communications by fax (and that lie beyond the Office's control), **fax can no longer be offered and will no longer be used**, as a means of communication in procedures before the Office.

#### 3.1.1 Via the User Area (electronic means)

The accepted means of electronic communication with the Office in **procedures relating to EUTMs and Community designs** is the User Area, which is a secure electronic communications platform maintained by the Office. The User Area enables users to submit applications and other documents, receive notifications and documents sent by the Office, reply to these notifications and perform other actions.

Nevertheless, exceptionally, where a technical malfunction prevents the applicant from filing through the User Area, an **EUTM or RCD application** submitted by one of the alternative electronic back-up measures available (see below) will be deemed to have been received by the Office provided that the applicant resubmits, within 3 working days of the original submission, the application for registration of an EUTM or RCD (with the same content) through the User Area, together with the confirmation of receipt clearly identifying the original submission. Failure to comply with these conditions will result in the original submission being deemed as not having been received. For further information on the submission of an **application for renewal of an EUTM or RCD** by one of the alternative electronic back-up measures available, see the Guidelines, [Part E, Register Operations, Section 4, Renewal, paragraph 7](#).

To facilitate resubmission, in the event of a malfunction during the electronic transmission of an application, communication or other document through the specific

e-operation or e-filing in the User Area, the Office will make two alternative electronic back-up measures available:

1. an upload solution located in the Communications section of the User Area - this is a general upload platform that allows documents to be attached and sent to the Office;
2. a file-sharing solution outside the User Area; the Office will provide the account holder with access to a secure file-sharing location where the document(s) in question can be uploaded.

Technical details on the accessibility and functionality of both these alternative back-up measures are available in the [Conditions of Use of the User Area](#).

In the unlikely event that these back-up measures are not available, the Executive Director may take a decision to extend the deadlines pursuant to [Article 101\(3\) EUTMR](#) and Article 58 CDIR (see [paragraph 4.2](#)).

The time of receipt of applications, communications or documents submitted by electronic means is the local time in Alicante (Spain) when the receipt was validated.

A series of e-operations (e-filings, e-actions and other e-operations) can be carried out via the User Area. These are accessible after logging into the User Area through the 'Dashboard' or the 'Online Services' sections of the account.

In addition, in certain *inter partes* proceedings, when both parties are registered users of the User Area they can file joint requests that are validated (signed) electronically by the two parties.

If an account holder uses one of the standard e-operations in the User Area to file a submission, that e-operation will prevail over any other statement or observation made by the account holder through other means on the same day, provided that the Office does not receive a withdrawal of the e-operation on the same day (see [paragraph 3.1.6](#)) for same day withdrawals).

Where a communication submitted by electronic means, is incomplete or illegible, or the Office has reasonable doubts as to the accuracy of the transmission, in accordance with [Article 63\(3\) EUTMDR](#) and Articles 67(3) and 66(2) CDIR, it will advise the sender and invite it to retransmit the communication or to submit a signed original of the document in question to the Office by post or any other available means within a specified deadline. If the retransmission is complete, the date of receipt will be considered to be the date of the first transmission, except for the purposes of establishing a filing date for an application. Otherwise, the Office will not take the transmission into account or will consider only the received and/or legible parts (04/07/2012, [R 2305/2010-4](#), HOUBIGANT/ PARFUMS HOUBIGANT PARIS et al.).

For further information on the filing date, see the Guidelines, [Part B, Examination, Section 2, Formalities](#) and the Guidelines for [Examination of Applications for Registered Community Designs](#).

For further information on the User Area, and in particular on the proper use of the user account and the sanctions imposed in the event of the prohibited disclosure of User Area credentials, please see paragraph 4(b) of the [Conditions of use of the user area](#),

annexed to Decision No [EX-20-9](#) of the Executive Director of the Office of 3 November 2020 on communication by electronic means.

### 3.1.2 By post or courier service

Documents sent by post or courier service should be sent to the Office's official address.

Documents sent by post or courier service must bear an original signature. If a document sent to the Office is not signed, the Office will invite the party concerned to do so within a specific deadline. If the document is not signed within that time, the application or request will be declared inadmissible, or the document will not be taken into account, as the case may be.

The date of receipt is the date on which the Office receives the communication irrespective of when it was placed in the mail or postal system (28/09/2016, [T-400/15](#); CITRUS SATURDAY / CITRUS, EU:T:2016:569, § 25; 15/03/2011, [T-50/09](#), Dada & Co / kids, EU:T:2011:90, § 67). The time of receipt is the local time in Alicante (Spain).

For further information on copies of the documents submitted in *inter partes* proceedings, see [the Guidelines, Part C, Opposition, Section 1, Opposition Proceedings, paragraph 4.2, Substantiation](#); and [the Guidelines for Examination of Design Invalidity Applications, paragraph 4.1, Exchange of communications](#).

### 3.1.3 Annexes to communications

Pursuant to [Article 55 EUTMDR](#), any documents or other items of evidence submitted by the party in EUTM proceedings must be contained in an annex to the submission, be numbered, be accompanied by an index with a short description of each item of evidence together with the number of pages, if applicable, and the page number where it is mentioned in the submission.

During the proceedings stage (i) when the evidence is not structured in numbered annexes; (ii) no index is sent (this meaning, when the required content of the index is not identifiable in any form); or (iii) when, on its own motion or after it being questioned by the other party, the Office finds it justified, in particular when it considers that the failure to comply with the relevant requirements significantly impairs the Office's or the other party's ability to review and assess the documents or items of evidence submitted and to understand the relevance of the same, a deficiency will be raised. A deficiency will not be raised if the content of the annexes is included in the text of the observations.

In *inter partes* proceedings

- annexes submitted by electronic means do not need to be submitted in duplicate;
- annexes submitted by post or courier consisting of paper documents (such as loose sheets of evidence) up to and including size A3 do not need to be submitted in duplicate;

- annexes submitted by post or courier consisting of paper documents larger than A3 or not on paper (e.g. data carriers, physical items of evidence such as product samples) must be submitted in duplicate, with one copy to be sent to the other party.

Where in *inter partes* proceedings relating to EUTMs, a copy is required but not provided, the annexes in question will not be taken into account. However, in *inter partes* proceedings relating to Community designs, the Invalidity Division may invite the party to file a duplicate within a specified deadline.

For further information on items of evidence to be submitted in *inter partes* proceedings for the purpose of establishing use, see [the Guidelines, Part C, Opposition, Section 1, Opposition Proceedings, paragraph 5.3.2.1, Means of evidence, Principles](#).

In addition to the requirements of [Article 55\(2\) EUTMDR](#), the Office recommends that the following key aspects of a structured presentation be taken into account in order to facilitate the processing and handling of the files:

1. to ensure a manageably sized file, parties should limit their submissions to items of evidence that are relevant to the case and to the ground/argument in question;
2. if the documentation is sent in different batches, each batch submitted should clearly indicate the total number of batches (including the total number of pages and the number of pages in each batch);
3. for physical specimens such as containers, packaging, etc. a photograph may be taken and submitted instead of the item itself and a duplicate (unless the electronic content of the item is relevant, as in the case of a data carrier);
4. where original documents or items are sent to the Office by mail, they should not be stapled, bound or placed in folders;
5. all items sent in duplicate for forwarding to the other party should be clearly identified; however, where the original is submitted to the Office by electronic means, no second copy needs to be sent.

#### 3.1.4 Data carriers

Annexes to communications may be submitted on data carriers.

The Office considers data carriers to be small portable storage devices such as USB flash drives, pen drives or similar memory units. External hard drives, memory cards, CD ROMs, DVDs and other optical discs, as well as magnetic data carriers of any kind are excluded.

The Office only accepts the file formats listed in Decision [No EX-22-7](#) of the Executive Director of the Office of 29/11/2022 on technical specifications for annexes submitted on data carriers, namely JPEG, MP3, MP4, PDF, TIFF, and for 3D models, STL, OBJ and X3D. The Office does not accept files in an executable file format (EXE), in a compressed file format or in an encrypted format, even if the resulting executed, decompressed or unencrypted file is in one of the acceptable file formats. Nor does the Office accept fillable PDF formats and PDF files that include added objects such as redacted (blacked-out) or added text, highlighted text or arrows.

The maximum size of each individual file saved on the data carrier is restricted to 20 MB (Article 4 of Decision [No EX-22-7](#)).

For further information, see Article 3 of Decision [No EX-22-7](#) of the Executive Director of the Office of 29/11/2022 on technical specifications for annexes submitted on data carriers.

If an annex on the data carrier does not comply with the acceptable type of data carriers under Article 2(1) or the technical specifications under Article 3 and 4 of Decision [No EX-22-7](#), the Office will deem it not to have been filed without inviting the party to overcome the deficiency (Article 6(a) [No EX-22-7](#)).

### 3.1.5 Signature

[Article 63\(1\) EUTMDR](#)

Article 65(1) CDIR

Applications and other communications to the Office must be signed by the sender.

If the application or other communication is filed by electronic means, the indication of the sender's name is deemed to be equivalent to a signature.

Where a submission or supporting document has to be signed, the signature must be accompanied by the name of the physical person signing and, if the signature is on behalf of a legal person (company), it must also include an indication of the role of the physical person in the company or their authority as signatory (e.g. Chief Executive Officer, President). The Office identification number (ID) may optionally also be indicated if available. If any of these identification elements are missing from the signature, the Office may issue a deficiency requesting the missing element(s). If a submission is not signed at all, the Office will invite the party concerned to correct the deficiency.

If a deficiency is notified, and is not remedied within the set time limit, the application will be rejected or the communication not taken into account.

For joint requests submitted in one single submission by electronic means in *inter partes* proceedings, the indication of the sender's name is deemed to be equivalent to its signature; however, the other party's signature must be presented in order for the request to be acceptable.

### 3.1.6 Confidentiality

[Article 114\(4\) EUTMR](#)

Article 72(c) CDIR

A party may, upon submitting a document or at a later stage, request that all or part of a document be kept confidential, as long as no request for an inspection of files is pending.

The party concerned must have expressly invoked, and sufficiently justified, a special interest in keeping the document confidential. For further details on invoking confidentiality and special interest, and on the examination process of confidential information, see [the Guidelines, Part E, Register Operations, Section 5, Inspection of Files, paragraph 5.1.3](#). Alternatively, the party may submit evidence in such a way that avoids revealing parts of the document or information that the party considers confidential, as long as the parts of the document submitted contain the required information. For example, where contracts or other documents are submitted as evidence, certain information may be blacked out before being submitted to the Office, or certain pages may be omitted altogether.

In principle, documents of a personal nature such as passports or other identification documents, which are submitted in particular as evidence in relation to requests for transfer, evidence of 'health data', which is submitted in particular as evidence in relation to restitutio in integrum or as supporting evidence for extension requests, and bank account extracts, which may, for example, be attached to applications and requests as evidence of fee payment, because of their inherent personal nature, confidentiality vis à vis any third parties is justified, and, in principle, overrides any third-party interest.

In *inter partes* proceedings, one of the parties might request the Office to keep certain documents confidential even vis-à-vis the other party in the proceedings. Although the Office can keep documents confidential vis-à-vis third parties (inspection of files), it can under no circumstances keep them confidential vis-à-vis the other party in *inter partes* proceedings. For further details concerning confidentiality in *inter partes* proceedings see [the Guidelines, Part C, Opposition Proceedings, Section 1, Opposition Proceedings, paragraph 4.4.4](#).

### 3.1.7 Withdrawal of communications

Submissions become effective upon receipt by the Office, provided that the Office does not receive a withdrawal of the submission on the same day. This means that a submission will only be annulled if a letter withdrawing its submission reaches the Office on the same day it was received.



### 3.1.8 References made to documents or items of evidence in other proceedings

[Article 115\(3\) EUTMR](#)

[Article 64\(2\) EUTMDR](#)

Article 76 CDIR

Decision No [EX-20-5](#) of the Executive Director of the Office of 15 June 2020 concerning the keeping of files

Decision No [EX-20-10](#) of the Executive Director of the Office of 22 December 2020 on technical specifications for annexes submitted on data carriers

The Office may receive observations from a party to the proceedings in which they refer to documents or evidence submitted in other proceedings, for instance, referencing evidence that has already been submitted in one opposition in another opposition.

Such references are acceptable when the party clearly identifies the documents they are referring to. They must indicate the following:

- (1) the number and the type of file;
- (2) the title of the document;
- (3) the number of pages of the document;
- (4) the date the document was sent to the Office.

For example, 'the statutory declaration that was submitted to the Office on dd/mm/yyyy in opposition proceedings B XXX XXX, together with exhibits 1 to 8, consisting of XX pages'.

If the original documents or evidence referred to are physical items of evidence (including data carriers) or paper documents exceeding A3 size, and this evidence is not available in the Office's electronic file, the party referring to this material must, pursuant to [Article 64\(2\) EUTMDR](#), submit by post or courier a second copy for transmission to the other party within the original time limit (see [paragraph 3.1.3](#)). If the party does not submit a copy, they will be invited to submit a second copy for transmission to the other party. If the party refers to all or some of the annexes provided previously on a data carrier, they must submit a copy of the annexes in question with the same content as the originals but complying with the current file sizes and format restrictions and recorded on an admissible type of data carrier (as detailed in Decision No [EX-20-10](#)).

A general reference to documents or evidence submitted in other proceedings will not be accepted. In such a situation the party making general reference to other documents or evidence may be invited to specify further within a given time limit. The party will be informed that this time limit granted by the Office must only be used to provide the clear and precise indication of the documents or evidence referred to. If not specified within this time limit, the reference to these documents or evidence will not be taken into account.



The parties should be aware that material submitted in other proceedings and not kept in electronic format may have been destroyed pursuant to [Article 115\(3\) EUTMR](#). In this case, the party will be invited to submit the original evidence again (original and copy for transmission to the other party). If the material referred to was on a data carrier that has since been destroyed, the new data carrier must have the same content as the original one, and must also comply with, inter alia, the current file sizes and format restrictions and be recorded on an admissible type of data carrier (as detailed in Decision No [EX-20-10](#)).

### 3.2 Notification by the Office

[Article 94\(2\)](#) and [Article 98 EUTMR](#)

Articles [56 to 62](#) EUTMDR

Article 41(1) and Articles 47 to 53 CDIR

Decision No [EX-18-4](#) of the Executive Director of the Office of 3 September 2018 concerning public notification

Decision No [EX-20-9](#) of the Executive Director of the Office of 3 November 2020 on communication by electronic means

Written communications from the Office to the party or parties to proceedings will be 'notified'. A document is considered to be **notified** when it has been received or is deemed to have been received by the addressee, irrespective of whether the addressee has been advised of this. Consequently, the date of notification of a document is the date on which that document is **made accessible to or has reached the addressee**, and not the date on which it was sent or the date on which the person to whom it was addressed actually learned of the notification. However, exactly when receipt is deemed to take place will depend on the method of notification.

The Office can choose freely the most appropriate means of notification, apart from public notification. In practice, the Office will always opt to notify by electronic means, whenever available.

If the proper notification procedure has been followed, the document is deemed to have been notified, unless the recipient can prove that it either did not receive the document at all, or received it late. If this is proved, the Office will re-notify the document(s). Conversely, where the proper notification procedure was not followed, the document will still be considered notified if the Office can prove that the document actually reached the recipient (13/01/2011, [T-28/09](#), Pine Tree, EU:T:2011:7, § 32).

Any communication or notification from the Office will indicate the department or division of the Office and the name(s) of the official(s) responsible. These documents have to be signed by the official(s) or, if not, bear the Office's printed or stamped seal.

### 3.2.1 Notification by electronic means

The User Area is the sole platform through which the Office will issue notifications by electronic means, and account holders may not opt-out of this means of receiving electronic communications from the Office as long as the User Area account remains active. This applies equally to new and existing user account holders, including those who may have previously opted-out under the former rules as set out in Article 3(1) of Decision of the Executive Director No [EX-19-1](#). The Office will therefore send all notifications through the User Area, unless this is impossible for technical reasons.

The date on which the document is placed in an account holder's inbox will be recorded by the Office and mentioned in the User Area. The document is deemed to have been notified on the fifth calendar day following the day on which the document is placed in the account holder's inbox, irrespective of whether the recipient actually opened and read it.

### 3.2.2 Notification by post or courier

The procedure for notification by post or courier will depend on the nature of the document notified.

Decisions subject to a deadline for appeal, summonses and other documents as determined by the Executive Director of the Office will be notified by courier service or registered post, in both cases with advice of delivery.

All other notifications can be sent either by courier service or registered post, with or without advice of delivery, or by ordinary post. If the recipient's address is not in the EEA or the addressee has not appointed a professional representative, the Office will send the document by ordinary post.

Notification will be deemed to have taken place 10 days after the document was posted. The recipient can only rebut this presumption by proving that it did not receive the document or that it received it later. Indications giving rise to reasonable doubt about correct receipt are considered to be sufficient proof (25/10/2012, [T-191/11](#), Miura, EU:T:2012:577, § 34).

In the event of a dispute, the Office must be able to establish that the notification reached its destination or the date on which it was delivered to the addressee. In this regard, the Office must establish that it had created the conditions for the document to be notified to arrive within the sphere of influence of the addressee. A distinction must be drawn between, first, the transmission of a document to the addressee, which is required for due notification, and, secondly, effective knowledge of that document, which is not required for the notification to be regarded as due notification. Existence of a valid notification to the addressee is in no way conditional on its having actually been brought to the notice of the person competent to deal with it under the internal rules of the entity addressed (22/11/2018, [T-356/17](#), RoB, EU:T:2018:845, § 31-32, and the case-law cited therein).

Notification by registered letter will be deemed to have been effected even if the addressee refuses to accept the letter.

### 3.2.3 Public notification by public notice

Public notification will be used for all notifications where the addressee's address is unknown or where a notification by post has been returned to the Office after at least one failed attempt.

This relates primarily to post returned to the Office by the Post Office marked 'not known at this address' and post that has not been claimed by the addressee.

Public notifications will be published on the Office's website. The document will be deemed to have been notified one month after the day on which it was posted on the internet.

## 4 Time Limits Specified by the Office

[Article 101 EUTMR](#)

Articles [67](#) to [69](#) EUTMDR

Articles 56 to 58 CDIR

Time limits before the Office can be divided into two categories:

- those laid down by the EUTMR, EUTMDR, EUTMIR, CDR or CDIR, which are therefore mandatory;
- those specified by the Office, which are therefore not mandatory and can be extended under certain circumstances.

Time limits are an essential tool for conducting orderly and reasonably swift proceedings. They are a matter of public policy and rigorous compliance with them is necessary to ensure clarity and legal certainty.

The regulations provide three measures that mitigate the rigorous application of the principle of strict observance of time limits (deadlines), depending on whether they are still running or have expired.

If the time limit is still running, the party may **request an extension** of the time limit pursuant to [Article 68 EUTMDR](#) and Article 57(1) CDIR.

In RCD proceedings, if the time limit has expired, the party that has missed it can request *restitutio in integrum* (pursuant to Article 67 CDR), which requires meeting formal and substantive requirements (such as showing all due care).

In EUTM proceedings, if the time limit has expired, the party that has missed it has two possible courses of action: it can either seek **continuation of proceedings** (pursuant to [Article 105 EUTMR](#)), which only requires meeting certain formal requirements, or it

can request *restitutio in integrum* (pursuant to [Article 104 EUTMR](#)), which requires meeting formal and substantive requirements (such as showing all due care).

Additional information is provided under paragraphs [4.4](#) and [4.5](#) below.

## 4.1 Length of the time limits specified by the Office

Regarding EUTM proceedings, with the exception of the time limits expressly specified in the EUTMR, EUTMDR, or EUTMIR, the time limits specified by the Office may not be less than one month or longer than six months.

Regarding RCD proceedings, with the exception of the time limits expressly specified in the CDR or CDIR, the time limits specified by the Office, when the party concerned has its domicile or its principal place of business or an establishment within the EU may not be less than one month or longer than six months. When the party concerned does not have its domicile or principal place of business or an establishment within the EU, the time limits may not be less than two months or longer than six months.

The general practice is to grant two months.

For further information, see [the Guidelines, Part A, General Rules, Section 5, Professional Representation](#).

## 4.2 Expiry of time limits

Under [Article 101\(1\) EUTMR](#), the calculation of a time limit starts on the day following the day on which the ‘relevant event’ occurred.

Where the Office sets a time limit in a notification indicating a time limit in terms of days, weeks or months (usually 2 months), the ‘relevant event’ is the date on which the document is notified or deemed notified, depending on the rules governing the notification. A notification issued by electronic means is deemed to have been notified on the fifth calendar day following the day on which the document is placed in the account holder’s inbox (see [paragraph 3.2.1](#)) and a notification issued by post or courier is deemed to have been notified on the tenth day after it was posted (see [paragraph 3.2.2](#)).

Where a time limit is expressed in months, it will expire in the relevant subsequent month on the same day as the day on which the ‘relevant event’ occurred.

It is immaterial whether the ‘relevant event’ occurred on a working day, a holiday or a Sunday; that is relevant only for the expiry of the time limit.

Where the relevant subsequent month has no day with the same number, the time limit in question will expire on the last day of that month. A 2-month time limit specified in a notification on 31 July will therefore expire on 30 September.

The same applies to time limits expressed in weeks or years.

Any time limit will be deemed to expire at midnight on the final day (local time in Alicante (Spain)).

In the event a time limit is missed, there is no provision requiring the Office to inform a party of the procedures available to it under Articles [104](#) and [105](#) EUTMR, nor, *a fortiori*, is it incumbent on it to advise that party to pursue any particular legal remedy. Therefore, the principle of sound administration is not violated by the Office for not informing of the means for rectifying a late submission (04/05/2018, [T-34/17](#), SKYLEADER (fig.), EU:T:2018:256, § 43).

A time limit that expires on a day on which the Office is not open for the receipt of documents or on which ordinary post is not delivered in the locality in which the Office is located (Saturdays, Sundays and public holidays) will be extended to the first working day thereafter. For this purpose, the Executive Director of the Office determines the days on which the Office is closed before the start of each calendar year. The extension is automatic but it applies only at the end of the time limit (12/05/2011, [R 924/2010-1](#), whisper power (fig.) / WHISPER).

In the event of a 'general interruption' to the postal service in Spain or of an 'actual interruption' of the Office's connection to authorised electronic means of communication, any time limit that expires during that period will be extended to the first working day after the period of interruption. These periods will be determined by the Executive Director of the Office; the extension will apply to all parties to the proceedings.

Not every technical error is regarded as an 'actual interruption of the Office's connection to admitted electronic means' under [Article 101\(3\) EUTMR](#), Article 58 CDIR. An actual interruption requires electronic communication (including all back-up options) to be disrupted for **at least 6 consecutive hours during the same working day**. For shorter interruptions, the Office will not extend the time limits under [Article 101\(3\) EUTMR](#). Parties should be wary, therefore, of filing submissions on the last day of a time limit, especially after Office working hours. If a party misses a deadline, it may consider filing a request for *restitutio in integrum* (see [paragraph 4.5](#)) or for continuation of the proceedings (see [paragraph 4.4](#)).

In the event of an exceptional occurrence (strike, natural disaster, etc.) causing a disruption to the running of the Office or a serious impediment to its communication with the outside world, time limits may be extended for a period determined by the Executive Director of the Office.

### 4.3 Extension of time limits

In **ex parte proceedings** before the Office, if a request is made for an extension before the time limit expires, then a further period should be allowed, depending on the circumstances of the case, but not exceeding six months.

For the rules applicable to the extension of time limits in **inter partes proceedings** (i.e. where there are two or more parties involved, such as in opposition, invalidity and/or

revocation proceedings), see [the Guidelines, Part C, Opposition, Section 1, Opposition Proceedings](#), and [the Guidelines for Examination of Design Invalidity Applications](#).

As a general rule, the first request for an extension that is received in time will be considered appropriate and will be granted for a period equal to the original term (or less if requested). However, any subsequent request for an extension of the same time limit will be refused unless the party requesting it can explain and justify the 'exceptional circumstances' that (a) prevented it from carrying out the required action during the previous two periods (i.e. the original time limit plus the first extension) and (b) still prevent the requester from carrying it out, so that more time is needed.

Examples of justifications that can be accepted:

- 'Evidence is being gathered from distribution channels/all our licensees/our suppliers in several Member States. So far, we have gathered documents from some of them but, due to the commercial structure of the company (as shown in the document enclosed), we have only recently been able to contact the rest.'
- 'In order to show that the mark has acquired distinctiveness through use we started carrying out market research at the beginning of the period (on date X). However, the fieldwork has only recently been concluded (as shown in the enclosed documents); consequently, we need a second extension in order to finish the analysis and prepare our submissions to the Office.'
- 'Death' is also considered an 'exceptional circumstance'. The same applies to serious illness, provided that no reasonable substitution was available.
- Finally, 'exceptional circumstances' also include 'force majeure' situations. 'Force majeure' is defined as a natural and unavoidable catastrophe that interrupts the expected course of events. It includes natural disasters, wars and terrorism, and unavoidable events that are beyond the party's control.

Where a request is filed for an extension to an extendable time limit before this time limit expires and is not accepted, the party concerned will be granted at least one day to meet the deadline, even if the request for an extension arrives on the last day of the time limit.

#### 4.4 Continuation of proceedings

##### [Article 105 EUTMR](#)

Continuation of proceedings is not available in RCD proceedings.

The expressions 'further processing' and 'continuation of proceedings' have the same meaning.

[Article 105 EUTMR](#) provides for the continuation of proceedings where time limits have been missed but excludes various time limits laid down in certain articles of the EUTMR.

The **excluded** time limits are the following:

- those laid down in [Article 104 EUTMR](#) (*restitutio in integrum*) and [Article 105](#) itself (continuation of proceedings), in order to avoid double relief for missing the same time limit;
- those referred to in [Article 139 EUTMR](#) , that is to say, the three-month period within which conversion must be requested and the conversion fee paid;
- the opposition period and the time limit for paying the opposition fee laid down in [Article 46 EUTMR](#) ;
- those laid down in [Article 32](#) (payment of the application fee), Articles [34\(1\)](#) (right of priority), [38\(1\)](#) (right of exhibition priority), [41\(2\)](#) (period to remedy filing deficiencies) and [53\(3\)](#) (period for renewal), [Article 68](#) (appeal) and [Article 72\(5\) EUTMR](#) (appeal before the Court of Justice), and the time limits laid down by the EUTMR for claiming, after the application has been filed, seniority within the meaning of [Article 39 EUTMR](#) .

However, none of the time limits in **opposition proceedings** (other than the time limit for filing an opposition and paying the applicable fee, as mentioned above) are excluded. Consequently, continuation of proceedings is available for missing:

- the time limit under [Article 146\(7\) EUTMR](#) to translate the notice of opposition;
- the time limit under [Article 5\(5\) EUTMDR](#) to remedy deficiencies that affect the admissibility of the opposition;
- the time limits for the opponent to substantiate its opposition under [Article 7 EUTMDR](#) ;
- the time limit laid down in [Article 8\(2\) EUTMDR](#) for the applicant to reply;
- the time limit under [Article 8\(4\) EUTMDR](#) for the opponent to reply;
- the time limits for any further exchange of arguments, if allowed by the Office ( 07/12/2011, [R 2463/2010-1](#) , Pierre Robert/ Pierre Robert (fig.) );
- the time limit under [Article 10\(1\) EUTMDR](#) for the applicant to request that the opponent prove use of its earlier mark;
- the time limit under [Article 10\(2\) EUTMDR](#) for the opponent to submit proof of use of its earlier mark;
- the time limit under [Article 10\(6\) EUTMDR](#) to translate proof of use.

Furthermore, [Article 105 EUTMR](#) does not exclude any of the time limits that apply in proceedings for **revocation** or **declaration of invalidity**.

The party seeking continuation of proceedings must make the request, for which a fee is charged as established in [Annex I of the EUTMR](#) , within two months of the expiry of the original time limit and complete the omitted act by the time the request for continuation is received. There is no substantive requirement to be fulfilled such as when requesting *restitutio in integrum*; i.e. there is no need to justify the missing of the time limit.

- Request to be submitted **within two months of the expiry of the original time limit**

The two months available for submitting a request for continuation of proceedings is an **objective** time limit and it is **non-extendable**. Consequently, unlike in the case of *restitutio in integrum*, it is irrelevant when the reason of non-compliance with the



original time limit has been removed or when the party became aware of missing the original time limit.

The request is deemed to be received only once the applicable fee has been paid (400 EUR).

Once a request for continuation of proceedings has been **granted**, the time limit is deemed to be observed and the opportunity of continuation of proceedings is exhausted. Hence, any **subsequent** request for a continuation of proceedings for the same time limit is, by definition, inadmissible, even if submitted within the time remaining of the two months available for submitting such a request. Conversely, where the initial request for continuation of proceedings is **rejected**, a **subsequent** request for continuation of proceedings will be accepted if it is submitted within the time remaining of the two months available for submitting such a request (and the other requirements are also complied with, i.e. the fee is paid and the omitted act is carried out).

- Omitted act must be carried out **together with the request**

The omitted act must be carried out together with the request. The Office also accepts if the omitted act is carried out **before submission of the request**, so long as the request is made within the two months of the expiry of the original time limit.

However, if the omitted act is carried out **after the submission of the request**, the request for continuation of proceedings will be rejected as inadmissible. This is so even in the case where the omitted act is carried out subsequent to the request, but still within the time remaining of the two months open for such a request.

- Omitted act must be **carried out**

The party requesting continuation of proceedings must perform the procedural act whose time limit it missed (e.g. submit evidence in support of the opposition, request proof use, submit observations in reply to the opposition). If the omitted act is not carried out, the request will be rejected as inadmissible. A request for an extension of time cannot substitute the completion of the omitted act.

The verification of the admissibility of the request does not entail an examination of whether the submission complies with the **substantive** legal requirements of the omitted act. Therefore, notwithstanding that a request for continuation of proceedings may have been found admissible and the relevant fees charged, the submission for 'carrying out the omitted act' may be found not to comply with the **substantive legal requirements** of the act concerned. Therefore, parties should prepare their submissions completing the omitted act with utmost care so that the request for continuation of proceedings could serve its purpose.

Examples:

- in the case of missing the time limit for **substantiation of the opposition**, if together with the request for continuation of proceedings the party submits documents with the purpose of substantiating the opposition, the omitted act will be considered to have been 'carried out' and the request for continuation of proceedings will be granted. However, that evidence may be found to be



insufficient to substantiate the opposition later in the course of its **substantive** examination;

- in the case of missing a time limit for **submitting proof of use** in opposition proceedings, if together with the request for continuation of proceedings the party submits documents with the purpose of proving genuine use, the omitted act will be considered to have been 'carried out' and the request for continuation of proceedings will be granted. However, that evidence may be found to be insufficient to prove genuine use later in the course of its **substantive** examination;
- in the case of missing a time limit for **requesting proof of use** in opposition proceedings, if together with the request for continuation of proceedings the party submits a properly formulated request for proof of use (i.e. unambiguous, unconditional and submitted in a separate document, in compliance with the formal requirements laid down in [Article 10\(1\) EUTMDR](#) ), but the earlier mark is not yet subject to the requirement of use (thus does not satisfy the **substantive** requirement of [Article 47\(2\) or \(3\) EUTMR](#) ), the omitted act will be considered to have been 'carried out' and the request for continuation of proceedings will be granted, however, the request for proof of use will be rejected.

However, the **formal** requirements of the omitted act must be complied with in order for the omitted act to be considered as duly **introduced** and, thus, 'carried out'.

Example:

- in the case of missing a time limit for **requesting proof of use** in opposition proceedings, if under a separate heading **within** the request for continuation of proceedings (i.e. not in a separate document as required by [Article 10\(1\) EUTMDR](#) ) the party requests proof of use, the request for proof of use will not be considered to have been **introduced**, and thus, the omitted act will not be considered to have been 'carried out'. The request for continuation of proceedings will be rejected as inadmissible.
- Outcome of the request

If the Office **accepts** the request for continuation of proceedings, the consequences of having failed to observe the time limit will be deemed not to have occurred. If a decision has been taken between the expiry of that time limit and the request for the continuation of proceedings, the department competent to decide on the omitted act will review the decision and, where completion of the omitted act itself is sufficient, take a different decision. If, following the review, the Office concludes that the original decision does not need to be altered, it will confirm that decision in writing.

If the Office **rejects** the request for continuation of proceedings, the fee will be refunded, or if not yet debited from the party's current account, it will not be charged ( [Article 105\(5\) EUTMR](#) ). However, as stated above, the party may introduce a new request if there is still time remaining of the two months open for such a request.

#### **4.5      *Restitutio in integrum***

A party to proceedings before the Office may be reinstated in its rights (*restitutio in integrum*) if, in spite of all due care required by the circumstances having been taken, it was unable to meet a time limit vis-à-vis the Office, provided that the failure to meet the time limit had the direct consequence, by virtue of the provisions of the regulations, of causing the loss of any right or means of redress.

For further information see [the Guidelines, Part A, General Rules, Section 8, \*Restitutio in Integrum\*](#).

***GUIDELINES FOR EXAMINATION***  
***EUROPEAN UNION***  
***INTELLECTUAL PROPERTY OFFICE***  
***(EUIPO)***

***Part A***

***General rules***

***Section 2***

***General principles to be respected in the  
proceedings***

## Table of Contents

<b>1 Adequate reasoning.....</b>	<b>38</b>
<b>2 The Right to Be Heard.....</b>	<b>39</b>
<b>3 Other General Principles of EU Law.....</b>	<b>40</b>
<b>4 Means of Taking Evidence.....</b>	<b>41</b>
<b>4.1 Written evidence.....</b>	<b>41</b>
<b>4.2 Oral evidence and inspections.....</b>	<b>43</b>
<b>4.3 Specific means of evidence.....</b>	<b>43</b>
4.3.1 Commissioning of experts by the Office.....	43
4.3.2 Affidavits.....	44
4.3.3 Inspections.....	44
<b>5 Oral Proceedings.....</b>	<b>45</b>
<b>5.1 Summons to oral proceedings.....</b>	<b>45</b>
<b>5.2 Language of oral proceedings.....</b>	<b>46</b>
<b>5.3 Course of the oral proceedings.....</b>	<b>46</b>
<b>5.4 Minutes of oral evidence and of oral proceedings.....</b>	<b>47</b>
<b>5.5 Costs of taking evidence in oral proceedings.....</b>	<b>47</b>
<b>6 Decisions.....</b>	<b>48</b>
<b>6.1 Contents.....</b>	<b>48</b>
<b>6.2 Apportionment of costs.....</b>	<b>48</b>
<b>6.3 Public availability of decisions.....</b>	<b>49</b>

## 1 Adequate reasoning

Articles [94 to 97](#) and [109](#) EUTMR

Articles 62 to 65 and 70 CDR

Article 38 CDIR

Office decisions will be in writing and will state the reasons on which they are based. The reason for this is twofold: to explain to interested parties why the measure was taken so that they can protect their rights, and to enable the Courts of the European Union to exercise their power to review the legality of the decision (12/07/2012, [T-389/11](#), Guddy, EU:T:2012:378, § 16; 22/05/2012, [T-585/10](#), Penteo, EU:T:2012:251, § 37, as well as the case-law cited; 27/06/2013, [T-608/11](#), Instruments for writing, EU:T:2013:334, § 67).

However, if the Office does not respond to all the arguments raised by the parties, this does not necessarily infringe the duty to state reasons (11/06/2014, [T-486/12](#), Metabol, EU:T:2014:508, § 19; 28/01/2014, [T-600/11](#), Carrera Panamericana, EU:T:2014:33, § 21; 15/07/2014, [T-576/12](#), Protekt, EU:T:2014:667, § 78; 18/11/2015, [T-813/14](#), Cases for Portable computers, EU:T:2015:868, § 15).

It is sufficient that it sets out the facts and legal considerations of fundamental importance in the context of the decision (18/01/2013, [T-137/12](#), Vibrator, EU:T:2013:26, § 41-42; 20/02/2013, [T-378/11](#), Medinet, EU:T:2013:83, § 17; 03/07/2013, [T-236/12](#), Neo, EU:T:2013:343, § 57-58; 16/05/2012, [T-580/10](#), Kindertraum, EU:T:2012:240, § 28; or 10/10/2012, [T-569/10](#), Bimbo Doughnuts, EU:T:2012:535, § 42-46, 08/05/2014, [C-591/12 P](#), Bimbo Doughnuts, EU:C:2014:305).

The Office can use facts that are a matter of common knowledge as a basis for its reasoning. Well-known facts are those that are likely to be known by anyone or that may be learnt from generally accessible sources (16/10/2014, [T-444/12](#), Linex, EU:T:2014:886, § 30; 22/06/2004, [T-185/02](#) Picaro, EU:T:2004:189, § 29; 09/02/2011, [T-222/09](#), Alpharen, EU:T:2011:36, § 29; 28/09/2016, [T-476/15](#), FITNESS, EU:T:2016:568, § 41; 17/09/2020, [C-449/18 P – C-474/18 P](#), MESSI (fig.) / MASSI et al., EU:C:2020:722, § 74).

The Office is not required to prove the accuracy of these well-known facts and, therefore, it is not obliged to give examples of such practical experience; it is up to the party concerned to submit evidence to refute it (20/03/2013, [T-277/12](#), Caffè Kimbo, EU:T:2013:146, § 46; 11/07/2013, [T-208/12](#), Rote Schnürsenkelenden, EU:T:2013:376, § 24; 21/02/2013, [T-427/11](#), Bioderma, EU:T:2013:92, § 19-22; 08/02/2013, [T-33/12](#), Medigym, EU:T:2013:71, § 20, 25; 07/12/2012, [T-42/09](#), Quadratum, EU:T:2012:658, § 73; 19/09/2012, [T-231/11](#), Stoffmuster, EU:T:2012:445, § 51).

Where a party argues that the circumstances of the proceedings are comparable to a previous Office decision, and the Office departs from the position taken in said decision, this needs to be addressed and particular explanations may be required (see

the Guidelines, [Part A, General Rules, Section 2, General principles to be respected in the proceedings, Paragraph 3, Other General Principles of EU Law](#) in relation to the principle of sound administration).

## 2 The Right to Be Heard

Articles [94 to 97](#) and [109](#) EUTMR

Article 62 CDR

The defence's right to be heard is a general principle of EU law, according to which a person whose interests are appreciably affected by a decision addressed to him or her by a public authority must be given the opportunity to make his or her point of view known. In accordance with that principle, the Office may base its decision only on matters of fact or of law on which the parties have been able to set out their views. Consequently, where the Office gathers facts to serve as a basis for its decision, it is obliged to notify the parties of those facts in order that the parties may submit their views on them (07/11/2014, [T-567/12](#), Kaatsu, EU:T:2014:937, § 50-51 and case-law cited therein).

The right to be heard covers all the matters of fact or law and evidence that form the basis for the decision.

The Office will take legal issues into account, irrespective of whether or not they have been pleaded by the parties. For examination, it will examine the facts on its own motion; however, in opposition, cancellation and design invalidity proceedings, it will restrict its examination of facts, evidence and arguments to those provided by the parties. Nevertheless, this restriction does not prevent the Office from taking additional well-known facts into consideration.

While the Office must rule on each head of claim (10/06/2008, [T-85/07](#), Gabel, EU:T:2008:186, § 20), it is not required to give express reasons for its assessment in respect of each and every piece of evidence submitted or arguments put forward, where it considers that evidence or arguments to be unimportant or irrelevant to the outcome of the dispute (15/06/2000, [C-237/98 P](#), Dorsch Consult v Council and Commission, EU:C:2000:321, § 51).

The right to be heard does not apply to the final position to be adopted. Therefore, the Office is not bound to inform the parties of its legal opinion before issuing a decision and thus afford them the opportunity to submit their observations on that position or even to submit additional evidence (09/07/2014, [T-184/12](#), Heatstrip, EU:T:2014:621, § 37; 14/06/2012, [T-293/10](#), Colour per se, EU:T:2012:302, § 46 *in fine*; 08/03/2012, [T-298/10](#), Biodanza, EU:T:2012:113, § 101; 20/03/2013, [T-277/12](#), Caffè Kimbo, EU:T:2013:146, § 45-46).

Changing circumstances arising in the course of the proceedings (e.g. if during opposition proceedings the earlier right on which the opposition was based lapses

because it is not renewed or is declared invalid) will also be taken into account and the parties will be informed accordingly.

### 3 Other General Principles of EU Law

The Office must respect the general principles of EU law, such as equal treatment and sound administration (24/01/2012, [T-260/08](#), Visual Map, EU:T:2012:23; 23/01/2014, [T-68/13](#), Care to care, EU:T:2014:29, § 51; 10/03/2011, [C-51/10 P](#), 1000, EU:C:2011:139, § 73).

For reasons of legal certainty and of sound administration, there must be a stringent and full examination of all applications in order to prevent trade marks and designs from being improperly registered. That examination must be undertaken in each individual case (23/01/2014, [T-68/13](#), Care to care, EU:T:2014:29, § 51).

The lawfulness of the Office's decisions must be assessed solely on the basis of EU regulations, as interpreted by the European Union judicature. Accordingly, the Office is not bound either by its previous decision-making practice or by a decision given in a Member State, or indeed a third country, that the sign/design in question is registrable as a national mark/design (23/01/2014, [T-513/12](#), Norwegian getaway, EU:T:2014:24, § 63). This is true even if the decision was adopted in a country belonging to the linguistic area in which the word sign in question originated (16/05/2013, [T-356/11](#), Equipment, EU:T:2013:253, § 7).

However, in the light of the principles of equal treatment and sound administration, the Office will take into account the decisions already taken in comparable cases and must carefully consider whether it should decide in the same way or not (28/06/2018, [C-564/16 P](#), DEVICE OF A JUMPING ANIMAL (fig.) / PUMA (fig.) et al., EU:C:2018:509, § 61 and 66; 10/03/2011, [C-51/10 P](#), 1000, EU:C:2011:139, § 74-75).

Moreover, the principle of equal treatment and sound administration must be applied in a manner that is consistent with the principle of legality, according to which a person may not rely, in support of his or her claim, on an unlawful act committed in another procedure (23/01/2014, [T-68/13](#), Care to care, EU:T:2014:29, § 51; 12/12/2013, [T-156/12](#), Oval, EU:T:2013:642, § 29; 02/05/2012, [T-435/11](#), UniversalPHOLED, EU:T:2012:210, § 38; 10/03/2011, [C-51/10 P](#), 1000, EU:C:2011:139, § 76-77).

## 4 Means of Taking Evidence

Articles [96 to 97](#) EUTMR

Articles [49 to 55](#) EUTMDR

Articles 64 to 65 CDR

Articles 42 to 46 CDIR

Decision No [EX-99-1](#) of the President of the Office of 12/01/1999 as amended by Decision No [EX-03-2](#) of the President of the Office of 20/01/2003

In any proceedings before the Office, evidence may be taken. The means for taking evidence are listed in [Article 97 EUTMR](#), [Article 51 EUTMDR](#), Article 65 CDR and Article 43 CDIR, although that list is not exhaustive.

The means of evidence are as follows:

- hearing the parties,
- requests for information,
- the production of documents and items of evidence,
- hearing witnesses,
- opinions by experts,
- sworn or affirmed statements in writing or statements having a similar effect under the law of the State in which they are drawn up,
- inspection.

Some of these means, such as requests for information, statements in writing and, in particular, the submission of documents and items of evidence, will be used more frequently than others. Hearing the parties, witnesses or experts, and inspections are used only exceptionally.

The Office will decide which of these means to use but will use them only when necessary for examining the file.

If the Office refuses a request to take evidence, an appeal can only be made together with the appeal against the final decision.

The procedure followed by the Office varies depending on the means of taking evidence proposed.

### 4.1 Written evidence

When taking evidence, the Office will confine itself to written evidence in most cases. This is the least costly, simplest and most flexible means of taking evidence.

The Office will therefore give preference to the submission of documents and items of evidence. However, other possible written means of taking evidence include not only a



request for information or statements in writing that have been sworn or affirmed or have a similar effect thereto under the law of the State in which they are drawn up, but also opinions by experts, which may consist solely of a written report.

The Regulations make no provision for any special procedure or formality. Therefore, the Office's general rules of procedure apply.

In EUTM proceedings, any documents or other items of evidence submitted by one party must be contained in an annex to the submission, be numbered, and be accompanied by an index, a short description of each item of evidence together with the number of pages, if applicable, and the page number of the submission where it is mentioned. In *inter partes* proceedings, unless submitted by electronic means, any supporting documents, including annexes or other evidence must be submitted in two copies (for further information see [the Guidelines, Part A, General Rules, Section 1, Means of Communication, Time Limits](#)). The written evidence will be communicated to the other party as soon as possible, and the Office may set the other party a time limit of, in principle, 2 months to reply.

A deficiency will be raised during the proceedings stage (i) when the evidence is not structured in numbered annexes; (ii) when no index is sent (that is to say, when the required content of the index is not identifiable in any form); or (iii) when, on its own motion or after being questioned by the other party, the Office finds it justified, in particular when it considers that the failure to comply with the relevant requirements significantly impairs the Office's or the other party's ability to review and assess the documents or items of evidence submitted and to understand the relevance of the same. A deficiency will not be raised if the content of the annexes is included in the text of the observations.

Any such deficiency may be overcome by structuring the evidence in numbered annexes, or submitting an index identifying the content of the annexes, as applicable.

Where the deficiency is not remedied within the period specified by the Office, and where it is still not possible for the Office to clearly establish to which ground or argument a document or item of evidence refers, that document or item will not be taken into account.

The Office will base its decision only on reasons on which both sides have had an opportunity to submit observations, and will identify those items of evidence not taken into account due to not fulfilling the requirements of [Article 55 EUTMDR](#).

No such specific provisions as to the format of document or items of evidence exist for RCD proceedings. Therefore, documents or items of evidence submitted by one party will be communicated to the other parties as soon as possible, and the Office may set the other parties a time limit of, in principle, 2 months to reply.

For further information on oral proceedings, see [paragraph 5](#) below.

## 4.2 Oral evidence and inspections

This refers to evidence taken in oral proceedings, such as hearing the oral evidence of parties, witnesses or experts, or carrying out inspections.

Only in exceptional cases will the Office decide to hear oral evidence, in particular because of the cumbersome nature of the procedure, which is liable to protract the proceedings, and because of the cost, which will have to be borne by the unsuccessful party in *inter partes* proceedings or, in some cases, by both parties.

Neither [Article 78\(1\)\(b\) EUTMR](#) nor [Article 51 EUTMDR](#) impose any obligation on the Office to summon witnesses to oral proceedings where requested by either party. In particular, oral proceedings are not normally necessary where the parties have been able to present their legal and factual arguments in writing.

Where oral proceedings are requested, it is for the requester to explain why the oral testimonies would be more apt to attest the truth of the facts alleged or why it was not able to provide those testimonies in writing or in any other form (18/01/2018, [T-178/17](#), HYALSTYLE, EU:T:2018:18, § 15 to 24).

If the Office invites one of the parties to give evidence orally, it will advise the other parties accordingly so that they can attend.

Similarly, when the Office summons an expert or a witness to a hearing, it will advise the parties concerned. These may be present and put questions to the person giving evidence.

## 4.3 Specific means of evidence

### 4.3.1 Commissioning of experts by the Office

Opinions by experts will be used only as a last resort because they involve substantial costs and protract the proceedings.

It is up to the Office to decide whether or not to commission an expert's opinion, who to appoint as expert and what form the opinion should take. However, the Office does not maintain a list of experts because it uses experts as a means of taking evidence only by way of exception.

The terms of reference of the expert include:

- a precise description of their task;
- the deadline for submitting their opinion;
- the names of the parties to the proceedings;
- details of any costs to be reimbursed by the Office.

The expert opinion must be submitted in the language of the proceedings or accompanied by a translation into that language. A copy of any written opinion, and of the translation if needed, must be submitted to the parties. If the Office considers the

report sufficient, and if the parties accept this form of report, it will in principle be used only in its written form.

The submission of an oral report or the hearing of oral evidence given by the expert will therefore be at the Office's discretion.

The parties can object to an expert on the grounds of incompetence or a conflict of interest, or because the expert was previously involved in the dispute or is suspected of partiality. No refusal may be based on the appointed expert's nationality. If a party objects to the expert, the Office will rule on the objection. The grounds that may be cited for objecting to an expert are the same as those for objecting to an examiner or Board of Appeal member pursuant to [Article 169 EUTMR](#) and Article 44(4) CDIR.

#### 4.3.2 Affidavits

Sworn or affirmed statements in writing or statements having a similar effect under the law of the State in which the statement is drawn up are equally admissible as evidence if submitted by a party.

In order for a statement to be considered sworn or affirmed, it must be understood by the parties that making a false statement would be considered a criminal offence under the law of the Member State in which the document was drawn up. Where that is not the case, the document will be considered simply as any other written document or statement (28/03/2012, [T-214/08](#), Outburst, EU:T:2012:161, § 32 and the case-law cited therein).

The evidential value of an affidavit is relative (28/03/2012, [T-214/08](#), Outburst, EU:T:2012:161, § 33). In assessing the evidential value of such a document, the Office will consider first and foremost the credibility of the account it contains. It will then take account, in particular, of the person who produced the document, the circumstances in which it came about, the person to whom it was addressed and whether, on the face of it, the document appears sound and reliable (07/06/2005, [T-303/03](#), Salvita, EU:T:2005:200, § 42 and the case-law cited therein; 18/11/2015, [T-813/14](#), Cases for portable computers, EU:T:2015:868, § 26). Affidavits containing detailed and concrete information and/or that are supported by other evidence have a higher probative value than very general and abstractly drafted statements.

The mere fact that affidavits from third parties are made according to a predetermined draft provided by the interested party (parties) does not in itself affect their reliability and credibility, and does not call into question their probative value since the veracity of their contents is certified by the signatory (16/09/2013, [T-200/10](#), Avery Dennison, EU:T:2013:467, § 73).

#### 4.3.3 Inspections

Only in very exceptional circumstances will the Office carry out an inspection *in situ*. If it does decide to carry out an inspection, it will take an interim decision to that end, stating the means by which it intends to obtain evidence (in the present case, an

inspection), the relevant facts to be proved, and the date, time and place of the inspection.

The date fixed for the inspection must allow the party concerned sufficient time to prepare for it. If the inspection cannot take place for any reason, the proceedings will continue based on the evidence on file.

## 5 Oral Proceedings

Articles [96 to 97](#) EUTMR

Articles [49 to 55](#) EUTMDR

Articles 64 to 65 CDR

Articles 42 to 46 and 82 CDIR

[Article 96 EUTMR](#) and Article 64 CDR provide that the Office may hold oral proceedings.

Any unofficial contacts such as telephone conversations will not be considered to constitute oral proceedings within the meaning of [Article 96 EUTMR](#) and Article 64 CDR.

The Office will hold oral proceedings either on its own initiative or at the request of any party to the proceedings only when it considers these to be absolutely necessary. This will be at the Office's discretion (20/02/2013, [T-378/11](#), Medinet, EU:T:2013:83, § 72 and the case-law cited therein; 16/07/2014, [T-66/13](#), Flasche, EU:T:2014:681, § 88). In the vast majority of cases it will be sufficient for the parties to present their observations in writing.

### 5.1 Summons to oral proceedings

Where the Office has decided to hold oral proceedings and to summon the parties, the period of notice may not be less than one month unless the parties agree to a shorter period.

Since the purpose of any oral proceedings is to clarify all outstanding points before the final decision is taken, the Office, in its summons, should draw the parties' attention to the points that need to be discussed in order for the decision to be taken.

Where the Office considers it necessary to hear oral evidence from the parties, witnesses or experts, it will take an interim decision stating the means by which it intends to obtain evidence, the relevant facts to be proven and the date, time and place of the hearing. The period of notice will be at least one month, unless the parties concerned agree to a shorter period. The summons will provide a summary of this decision and state the names of the parties to the proceedings and details of the costs, if any, that the witnesses or experts may be entitled to have reimbursed by the Office.

The Office may also offer the possibility of taking part in the oral proceedings by video conference or other technical means.

If required, and in order to facilitate the hearing, the Office may invite the parties to submit written observations or to submit evidence prior to the oral hearing. The period fixed by the Office for receiving these observations must allow sufficient time for them to reach the Office and then be forwarded to the other parties.

The parties may likewise submit evidence in support of their arguments on their own initiative. However, if this evidence ought to have been produced at an earlier stage of the proceedings, the Office will decide whether these items of evidence are admissible, taking account of the principle of hearing both parties, where appropriate.

## **5.2 Language of oral proceedings**

Oral proceedings will be in the language of the proceedings unless the parties agree to use a different official EU language.

The Office may communicate in oral proceedings in another official EU language and it may, upon prior written request, authorise a party to communicate in another official EU language provided that simultaneous interpretation of the communication into the language of proceedings can be made available. The costs of providing simultaneous interpretation will be paid by the party making the request or by the Office as the case may be.

## **5.3 Course of the oral proceedings**

Oral proceedings before the examiners, the Opposition Division and the department in charge of the Register will not be public.

Oral proceedings, including the delivery of the decision, will be public before the Cancellation/Invalidity Division and the Boards of Appeal, insofar as the department before which the proceedings are taking place does not decide otherwise in cases where admission of the public could have serious and unjustified disadvantages, in particular for a party to the proceedings.

If a party who has been duly summoned to oral proceedings does not appear before the Office, the proceedings may continue without them.

If the Office invites a party to give evidence orally, it will advise the other parties accordingly so that they can attend.

Similarly, when the Office summons an expert or a witness to a hearing, it will advise the parties concerned. These may be present and put questions to the person giving evidence.

At the end of the oral proceedings the Office will allow the parties to present their final pleadings.

## 5.4 Minutes of oral evidence and of oral proceedings

[Article 53 EUTMDR](#)

Article 46 CDIR

Minutes of the taking of oral evidence and of oral proceedings will be confined to the essential elements. In particular, they will not contain the verbatim statements made nor be submitted for approval. However, any statements by experts or witnesses will be recorded so that at further instances the exact statements made can be verified.

Where oral proceedings or the taking of evidence before the Office are recorded, the recording will replace the minutes.

The parties will receive a copy of the minutes.

## 5.5 Costs of taking evidence in oral proceedings

The Office may make the taking of evidence conditional upon a deposit by the party requesting it. The amount will be fixed by the Office based on an estimate of the costs.

The witnesses and experts summoned or heard by the Office will be entitled to reimbursement of expenses for travel and subsistence, including an advance. They will also be entitled to compensation for loss of earnings and payment for their work.

The amounts reimbursed and the advances for expenses are determined by the Executive Director of the Office and are published in the Office's Official Journal. For details, see Decision No [EX-99-1](#) of the President of the Office of 12/01/1999 as amended by Decision No [EX-03-2](#) of the President of the Office of 20/01/2003.

Where the Office decides to adopt means of taking evidence that require oral evidence from witnesses or experts, the Office will bear the cost of this. However, where one of the parties has requested oral evidence, then that party will bear the cost, subject to a decision on the apportionment of costs in *inter partes* proceedings.

## 6 Decisions

### 6.1 Contents

[Article 94 EUTMR](#)

Article 62 CDR

Articles 38 to 41 CDIR

Office decisions will be reasoned to such an extent that their legality can be assessed at the appeal stage or before the General Court or Court of Justice.

The decision will cover the relevant points raised by the parties. In particular, if there are different outcomes for some goods and services of the EUTM application or registration concerned, the decision will make clear which of the goods and services are refused and which are not.

The name or names of the person(s) who took the decision will appear at the end of the decision.

At the end of the decision, there will also be a notice advising of the right to appeal.

Failure to include this notice does not affect the legality of the decision and does not affect the deadline for filing an appeal.

### 6.2 Apportionment of costs

[Article 105\(5\)](#), [Article 109](#) and [Annex I A\(33\)EUTMR](#)

[Article 33 EUTMDR](#)

Article 70 CDR

Articles 37 and 79 CDIR

Article 24 of the Annex to the CDFR

‘Costs’ comprise the costs incurred by the parties to the proceedings, chiefly (i) representation costs and costs for taking part in oral hearings (‘representation costs’ means the costs for professional representatives within the meaning of [Article 120 EUTMR](#) and Article 78 CDR, not for employees — not even those from another company with economic links); and (ii) the opposition, cancellation or invalidity fee.

‘Apportionment of costs’ means that the Office will decide whether and to what extent the parties have to reimburse each other. It does not involve the relationship with the Office (fees paid, the Office’s internal costs).

In *ex parte* proceedings, there is no decision on costs, nor any apportionment of costs. The Office will not reimburse any fees paid (the exceptions are [Article 33 EUTMDR](#) and Article 37 CDIR, refund of the appeal fee in certain cases, and [Article 105\(5\) EUTMR](#), refund of the fee for continuation of proceedings if the application is not granted).

Decisions on costs, or the fixing of costs, are limited to opposition, cancellation and design invalidity proceedings (including the ensuing appeal proceedings or proceedings before the GC and CJEU).

If a decision is given in *inter partes* proceedings, the Office will also decide on the apportionment of costs.

The decision will fix the costs to be paid by the losing party/parties. The losing party will bear the fees and costs incurred by the other party that are essential to the proceedings. No proof that these costs were actually incurred is required.

If both parties fail on one or more heads or if reasons of equity so dictate, the Office may determine a different apportionment of costs.

If the contested EUTM application, EUTM or RCD is withdrawn or surrendered, or the opposition, request for cancellation or application for a declaration of invalidity is withdrawn, the Office will not decide on the substance of the case, although it will normally take a decision on costs. The party terminating the proceedings will bear the fees and costs incurred by the other party. Where the case is closed for other reasons, the Office will fix the costs at its discretion. This part of the decision can be enforced in simplified proceedings in all Member States of the EU once it becomes final.

In no case will the decision on costs be based on hypothetical assumptions about who might have won the proceedings if a decision on substance had been taken.

Furthermore, within one month of the date of notification fixing the amount of the costs, the party concerned may request a review. This request must state the reasons on which it is based and must be accompanied by the corresponding fee.

For further information see [the Guidelines, Part C, Opposition, Section 1, Opposition Proceedings, paragraph 6.5](#) and [the Guidelines on Examination of Design Invalidity Applications](#).

### **6.3 Public availability of decisions**

#### [Article 113 EUTMR](#)

Decision No [EX-21-4](#) of the Executive Director of the Office of 30 March 2021 on the Register of EU trade marks, the Register of Community designs, the database of proceedings before the Office, and on the case-law database.

To promote convergence of practices, the Office maintains a case-law database, making publicly available Office decisions defined by the EUTMR, the CDR and the legislative acts adopted pursuant to them, as well as judgments of national and EU courts in intellectual property matters.



For reasons of transparency and in the interest of the public, the Office makes its decisions publicly available upon their notification, irrespective of the fact whether the decisions have become final. This includes making decisions publicly available following the examination of an EUTM application upon their notification, although the EUTM application may remain unpublished following its refusal or a withdrawal of the EUTM application (see the Guidelines, [Part B, Examination, Section 1, Proceedings, paragraph 4, Publication](#)). It also includes decisions even if they are annulled at a later stage, or if they do not become final for any other reason.

The Office's decisions will be kept in the database. Requests for removal of decisions from the database will be refused.

However, before the publication of an RCD pursuant to Article 49 or Article 50(4) CDR, public availability of Office decisions is subject to the restrictions laid down in Article 50(2) and (3) CDR and Article 14(3) CDIR. These include RCD applications refused before reaching registration, and registered RCDs subject to deferment of publication. In both cases the disclosure of content is subject to the restrictions in the aforementioned articles.

Making such decisions publicly available in the database is not to be confused with their entry in the register. The outcome of the decisions is recorded in the EUTM or RCD registers only once they are final.

The judgments and decisions are made available in their original language. Official translations are published where available. The case-law database may contain unofficial translations, where indicated, or may facilitate automatic machine translations for information purposes only.

The case-law database is accessible free of charge on the Office's website through the tool [eSearch Case Law](#).

***GUIDELINES FOR EXAMINATION***  
***EUROPEAN UNION***  
***INTELLECTUAL PROPERTY OFFICE***  
***(EUIPO)***

***Part A***

***General rules***

***Section 3***

***Payment of fees, costs and charges***

## Table of Contents

<b>1 Introduction.....</b>	<b>53</b>
<b>2 Means of Payment.....</b>	<b>54</b>
<b>2.1 Payment by bank transfer.....</b>	<b>54</b>
2.1.1 Bank accounts.....	54
2.1.2 Details that must accompany the payment.....	55
<b>2.2 Payment by debit or credit card.....</b>	<b>57</b>
<b>2.3 Payment by the Office current account.....</b>	<b>57</b>
<b>3 Time of Payment.....</b>	<b>60</b>
<b>4 Date on which Payment is Deemed to be Made.....</b>	<b>60</b>
<b>4.1 Payment by bank transfer.....</b>	<b>60</b>
4.1.1 Late payment with or without surcharge.....	60
4.1.2 Evidence of payment and of the date of payment.....	61
<b>4.2 Payment by debit or credit card.....</b>	<b>62</b>
<b>4.3 Payment by current account.....</b>	<b>62</b>
<b>5 Refund of Fees.....</b>	<b>63</b>
<b>5.1 Refund of application fees.....</b>	<b>63</b>
<b>5.2 Refund of the opposition fee.....</b>	<b>64</b>
<b>5.3 Refund of the fee for an application for revocation or for a declaration         of invalidity.....</b>	<b>64</b>
<b>5.4 Refund of fees for international marks.....</b>	<b>65</b>
<b>5.5 Refund of appeal fees.....</b>	<b>65</b>
<b>5.6 Refund of renewal fees.....</b>	<b>65</b>
<b>5.7 Refund of insignificant amounts.....</b>	<b>66</b>
<b>6 Fee Reduction for an EUTM Application Filed by Electronic Means.....</b>	<b>66</b>
<b>7 Decisions on Costs.....</b>	<b>67</b>
<b>7.1 Fixing of costs.....</b>	<b>67</b>
<b>7.2 Enforcement of the decision on costs.....</b>	<b>67</b>
7.2.1 Conditions.....	67
7.2.2 National authority.....	67
7.2.3 Proceedings.....	68
<b>7.3 Apportionment of costs.....</b>	<b>68</b>

## 1 Introduction

Articles [178 to 181](#) and [Annex I EUTMR](#)

Article 6 CDIR

Article 6 CDFR

The specific rules on the payment of fees and charges in European Union trade mark (EUTM) matters are laid down in Articles [178 to 181](#) and [Annex I EUTMR](#). The full list of fees can be found on the Office website.

Similarly, for registered Community designs (RCDs), in addition to the provisions contained in the basic CDR and in the CDIR, there is a specific regulation on the fees payable to the Office (CDFR). This regulation was amended in 2007 following the accession of the European Union to the Geneva Act of the Hague Agreement Concerning the International Registration of Industrial Designs.

Finally, the Executive Director of the Office is empowered to lay down charges that may be payable to the Office for services it may render and to authorise methods of payments in addition to those explicitly provided for in the EUTMR and the CDFR.

The differences between fees, costs and charges are as follows.

- **Fees** must be paid to the Office by users for the filing and handling of trade mark and design proceedings; the above regulations determine the amounts of the fees and the ways in which they must be paid. Most of the proceedings before the Office are subject to the payment of fees, such as the application fee for an EUTM or an RCD, renewal fees, etc. Some fees have been reduced to zero (e.g. registration fees for EUTMs, transfers for EUTMs).

The amounts of the fees have to be fixed at such a level as to ensure that the revenue is in principle sufficient for the Office's budget to be balanced (see [Article 172\(2\)](#) and [recital 39](#) of the EUTMR). In order to guarantee the full autonomy and independence of the Office, the Office's revenue comes principally from fees paid by the users of the system ([recital 37](#) of the EUTMR).

Rights of the Office to the payment of a fee are extinguished after 4 years from the end of the calendar year in which the fee fell due ([Article 108 EUTMR](#)).

- **Costs** refer to the costs of the parties in *inter partes* proceedings before the Office, in particular for professional representation (for trade marks see [Article 109 EUTMR](#) and Articles [18](#) and [27](#) EUTMR; for designs see Articles 70 to 71 CDR and Article 79 CDIR). Decisions in *inter partes* cases can contain, where necessary, a decision on fees and costs of the professional representatives, and must fix the amount. The decision on costs may be enforced once the decision has become final, pursuant to [Article 110 EUTMR](#).
- **Charges** are fixed by the Executive Director of the Office for any services rendered by the Office other than those specified in [Annex I EUTMR](#) ([Article 178 EUTMR](#)).

The amounts of the charges laid down by the Executive Director will be published in the Official Journal of the Office and can be found on the website under decisions of the Executive Director. Examples are the charges for mediation in Brussels or for certain publications issued by the Office.

The payment of a fee and indication of the nature of the fee and the procedure to which it refers does not dispense with the obligation to meet the other remaining formal requirements of the procedural act concerned unless expressly established in the EUTMR, the CDR and the secondary legislative acts (e.g. for renewals). For example, the payment of the appeal fee and the indication of the number of the contested decision is not sufficient for filing a valid notice of appeal (31/05/2005, [T-373/03](#), Parmitalia, EU:T:2005:191, § 58; 09/09/2010, [T-70/08](#), Etrax, EU:T:2010:375, § 23-25).

## 2 Means of Payment

### [Article 179\(1\) EUTMR](#)

Article 5 CDFR

Decision No [EX-21-5](#) of the Executive Director of the Office of 21/07/2021 concerning methods of payment of fees and charges and determining the insignificant amount of fees and charges

All fees and charges must be paid in euros. Payments in other currencies are not valid, do not create rights and will be reimbursed.

The admissible means of payment are, in most cases, bank transfers, debits from the current accounts held at the Office, and (for certain online services only) debit or credit cards. Cash payments at the Office's premises and cheques are no longer accepted (03/09/2008, [R 524/2008-1](#), Teamstar / TeamStar).

The Office cannot issue invoices. However, the Office will provide a receipt when requested to do so by the user.

### 2.1 Payment by bank transfer

Money may be sent to the Office by means of transfer. A fee is not deemed to be paid if the order to transfer is given after the end of the time limit. If the fee is sent before the time limit but arrives after its expiry, under specific conditions the Office may consider the fee has been duly paid (see [paragraph 4.1](#) below).

#### 2.1.1 Bank accounts

Payment by bank transfer can only be made to one of the Office's bank accounts. For details on these accounts, refer to the 'Fees and Payment' section of the Office's website (<https://euipo.europa.eu/ohimportal/en/fees-and-payments>).

Concerning bank charges, it is important to make sure that the entire amount reaches the Office without any deductions.

## 2.1.2 Details that must accompany the payment

[Article 179\(2\) and \(3\) EUTMR](#)

Article 6 CDFR

Every payment must indicate the name of the person making the payment and must include the information the Office needs to immediately identify the payment's purpose.

### 1. Name

Regarding **the name of the person making the payment**, the sender's full name must be included in the sender field of the bank transfer.

### 2. Purpose

Regarding the **payment's purpose**, the description field of the bank transfer must include the information needed to immediately identify the payment's purpose.

Additionally, it is recommended that contact details be provided either in the sender field or in the description field. This allows the Office to contact the person making the payment should this be necessary.

The Office provides users with a single **payment transaction code**. If a party selects 'bank transfer' as the payment method when filling out an online e-filing form in the User Area, the system will provide a unique eight-digit payment transaction code in the filing receipt. The first two digits stand for the current year, the next five digits are a mix of numbers and letters and the last is a control number (e.g. 2139EDH2).

**It is highly recommended to put the payment transaction code in the description field of the bank transfer, preferably at the beginning.** This field should also include the nature of the fee, for instance the type of proceedings in abbreviated form (see examples below), and the application or file number. Following these **two crucial items**, other information can be included, such as the name of the party or representative (when different from the person making the payment) and their Office ID number.

Properly filling in the name and description fields in the bank transfer will ensure that the Office identifies the payment correctly and deals with the applications or procedural acts in a timely manner. Since these fields have character limits, it is recommended to use abbreviations where possible and avoid excessive use of spaces or initial zeros in numbers.

The following are suggested abbreviations (or a combination thereof) for the most common transactions before the Office subject to a fee, and can be used, along with the payment transaction code, to assist in identifying the payment:

Description	Abbreviation
Application fee for EUTM or RCD	EUTM, RCD
International application fee	IA
Renewal fee	REN
Opposition fee	OPP
Cancellation fee	CANC
Appeal	R
Recordal	REC
Conversion	CONV
Inspection of files	IOF
Current Account	CA
Owner ID number	OWN ID
Representative ID number	REP ID

For example, when paying for an EUTM filing where a payment code has been provided (2132EDH2), the EUTM application number appears on the receipt (184583674) and it is filed by a Representative that has an ID with the Office (ID 1024891), the preferred description would be **'2132EDH2 EUTM 184583674 REP ID1024891'**.

Another example, where a Representative (ID 1024891) is making a payment to replenish a current account held with the Office (account No 6361), as there would be no individual payment transaction code, the preferred description would be **'CA6361 REP ID 1024891'**.

**Incorrect or insufficient information** identifying the file the payment is linked to can cause considerable delays in processing the applications or procedural acts.

When the information supplied is **insufficient for the Office to establish the purpose of the payment**, the Office will contact the person making the payment (if they provided their contact details), and specify a time limit within which the missing information must be provided, failing which the payment will be deemed not to have been made and the sum will be reimbursed (if the sender provides the necessary bank details).

Where there is **contradictory information** in the description field identifying more than one file or proceeding, the Office will contact the sender (if they provided their contact details), and specify a time limit for them to clarify which of the files the payment should be linked to. In the absence of clarification, the payment will in principle be considered to be for the file identified in first place in the payment description field. For example, a payment of EUR 850 for an EUTM application with two payment transaction codes (e.g. **'2132EDH2, 2141KHG1, EUTM'**) in the description field, each relating to a

different EUTM filing. Where the party does not reply to the Office's letter, the payment will be linked to the EUTM application first identified, namely, in the example, the one with the payment transaction code '2132EDH2'.

## 2.2 Payment by debit or credit card

Decision No [EX-21-5](#) of the Executive Director of the Office of 21/07/2021 concerning methods of payment of fees and charges and determining the insignificant amount of fees and charges

[Annex I A EUTMR](#)

Article 5(2) CDFR

Most online services can be paid for by debit or credit card, provided that payment is made for a service requested through the User Area. However, payment by debit or credit card is not yet available for all of the Office's fees. The relevant online tool (e.g. e-filing) will indicate when a fee can be paid by credit or debit card. In particular, debit or credit cards cannot be used to pay charges referred to in [Article 178\(1\) EUTMR](#) and Article 3 CDFR or for filling up a current account.

Debit or credit card payments allow the Office to make the best use of its own automatic internal systems, so that work on the file can start more quickly.

Debit or credit card payments are immediate (see [paragraph 4.2](#) below) and are therefore not allowed for making delayed payments (payments to be made within 1 month from the filing date).

Debit or credit card payments require some essential information. The information disclosed will not be stored by the Office in any permanent database. It will only be kept until it is sent to the bank. Any record of the form will only include the debit or credit card type plus the last four digits of the debit or credit card number. The entire debit or credit card number can safely be entered via a secure server, which encrypts all information submitted.

## 2.3 Payment by the Office current account

Decision No [EX-21-5](#) of the Executive Director of the Office of 21/07/2021 concerning methods of payment of fees and charges and determining the insignificant amount of fees and charges.

It is advisable to open a current account at the Office as, for any request that is subject to time limits, such as filing oppositions or appeals, the payment will be deemed to have been made on time, even if the relevant documentation for which the payment was made (e.g. a notice of opposition) is submitted on the last day of the deadline,



provided that the current account has sufficient funds (see [4.3 Payment by current account](#) on page 62) (07/09/2012, [R 2596/2011-3](#), Stair Gates, § 13-14). The date on which the current account is actually debited will usually be later, but payment will be deemed to have been made on the date on which the request for a procedural act is received by the Office, or as otherwise convenient for the party to the proceedings, in accordance with Article 8 of Decision No [EX-21-5](#) of the Executive Director of the Office of 21/07/2021 concerning methods of payment of fees and charges and determining the insignificant amount of fees and charges.

The following may hold current accounts (Article 3 of Decision No [EX-21-5](#) of the Executive Director of the Office of 21/07/2021; see the Guidelines, [Part A, Section 5, Parties to the Proceedings and Professional representation](#)):

1. natural or legal persons who, in accordance with Article 5 EUTMR and Article 1(b) CDR, may be proprietors of EU trade marks or holders of RCDs;
2. persons who may act as representatives in accordance with Article 120 EUTMR and Article 78 CDR;
3. associations of representatives;
4. natural or legal persons authorised by proprietors of EU trade marks or holders of RCDs for the purposes of Article 53(1) EUTMR or Article 13(1) CDR.

If the person that has filed the application or the respective procedural act is the holder of a current account with the Office, the Office will automatically debit the current account, unless instructions to the contrary are given in any individual case. In order for the account to be correctly identified, the Office recommends clearly indicating the Office ID number of the holder of the current account with the Office.

The system of current accounts is an automatic debiting system, meaning that upon identification of such an account, the Office may, according to the development of the procedures concerned and insofar as there are sufficient funds in the account, debit all fees and charges due within the limits of the aforementioned procedures, and a payment date will be accorded each time without any further instructions. The only exception to this rule is made when the holder of a current account who wishes to exclude the use of their current account for a particular fee or charge informs the Office thereof in writing. In this scenario, however, the holder of the account may change the method of payment back to payment by current account at any time before the expiry of the payment deadline.

The absence of an indication or the incorrect indication of the amount of the fee does not have any negative effect, since the current account will be automatically debited with reference to the corresponding procedural act for which the payment is due.

If there are insufficient funds in a current account, the holder will be notified by the Office and given the possibility to replenish the account with sufficient funds to allow for the payment of the fees concerned and of the administrative charge, which is 20 % of the total of the late fee. The administrative charge must not in any event exceed the maximum of EUR 500 or the minimum of EUR 100.

If the holder does replenish the account, the payment of the fee will be deemed to have been received on the date the relevant document in relation to which the payment was

made (for instance a notice of opposition) is received by the Office. If payment concerns the replenishment of a current account, it is sufficient to indicate the current account number.

Where the current account is replenished to cover only part of the amount due, the debit will be made, without exceptions, in the following order:

1. the administrative charges will be debited first; then,
2. if there are several fees or charges pending, the debit will be made in chronological order, taking into account the date when the fees were due, and only where the complete fee can be debited.

Where the current account is not replenished to cover all of the administrative charges and fees concerned on time, the payment will be deemed not to have been made and any rights depending on the timely payment will be lost.

The Office provides current account holders with access to their current account information over a secure internet connection. The account holder can view, save or print account movements and pending debits online via the User Area of the Office website.

Payment of a fee by debiting a current account held by a third party requires explicit written authorisation. The authorisation must be given by the holder of the current account and must state that the account can be debited for a specific fee. The authorisation must reach the Office before payment is due. Payment will be considered effective on the date the Office receives the authorisation.

If the holder is neither the party nor their representative, the Office will check whether such authorisation exists. Where the authorisation is not on file, the Office will inform the party concerned. In the absence of the submission of the holder's authorisation on time, that is, before payment is due, the party's request to debit the fee will be disregarded by the Office.

A current account can be opened at the Office either by emailing a request to [fee.information@euipo.europa.eu](mailto:fee.information@euipo.europa.eu) or by initiating an e-Action in the User Area.

The minimum amount required to open a current account is EUR 1 000.

Once an account has been opened, the Office reserves the right to close a current account by written notification to the holder, in particular where it deems that the use made of the current account was not in accordance with the terms and conditions laid down in Decision No [EX-21-5](#) of the Executive Director of the Office of 21/07/2021 concerning methods of payment of fees and charges and determining the insignificant amount of fees and charges, or when it is determined that there has been a misuse of the account. Misuse could be considered in situations such as systematic lack of funds, repeated misuse of third-party authorisations or multiple accounts, non-payment of administrative charges, or situations where the actions of the account holder have led to an excessive administrative burden on the Office. For more details on closure, reference is made to Article 13 of Decision No [EX-21-5](#) of the Executive Director of the Office of 21/07/2021 concerning methods of payment of fees and charges and determining the insignificant amount of fees and charges.

### 3 Time of Payment

[Article 178\(2\) EUTMR](#)

Article 4 CDFR

Fees must be paid on or before the date on which they become due.

If a time limit is specified for a payment to be made, then that payment must be made within that time limit.

Fees and charges for which the regulations do not specify a due date will be due on the date of receipt of the request for the service for which the fee or the charge is incurred, for example, a recordal application.

### 4 Date on which Payment is Deemed to be Made

[Article 180\(1\) and \(3\) EUTMR](#)

Article 7 CDFR

Decision No [EX-21-5](#) of the Executive Director of the Office of 21/07/2021 concerning methods of payment of fees and charges and determining the insignificant amount of fees and charges

The date on which a payment is deemed to be made will depend on the method of payment.

#### 4.1 Payment by bank transfer

When the payment is made by transfer or payment to an Office bank account, the date on which payment is deemed to have been made is the date on which the amount is credited to the Office bank account.

##### 4.1.1 Late payment with or without surcharge

A payment that is received by the Office after expiry of the time limit will be considered to have been made in due time if evidence is submitted to the Office that the person who made the payment (a) duly gave an order, within the relevant period for payment, to a banking establishment to transfer the amount of the payment, and (b) paid a surcharge of 10 % of the total amount due (up to a maximum amount of EUR 200). Both conditions must be fulfilled in accordance with the judgment of 12/05/2011, [T-488/09](#), Redtube, EU:T:2011:211, § 38, and decision of 10/10/2006, [R 203/2005-1](#), BLUE CROSS MEDICARE / BLUE CROSS.

The same is not true for the late payment of the surcharge. If the surcharge is late, the entire payment is late and cannot be remedied by the payment of a 'surcharge on the surcharge' (07/09/2012, [R 1774/2011-1](#), LAGUIOLE (fig.), § 12-15).

The surcharge will not be due if the person submits proof that the payment was initiated more than 10 days before expiry of the relevant time limit.

The Office may set a time limit for the person who made the payment after the expiry of the time limit to submit evidence that one of the above conditions was fulfilled.

For more information on the consequences of late payment in particular proceedings, see the relevant parts of the Guidelines. For example, the Guidelines, Part B, Examination, Section 2, Formalities, deals with the consequences of late payment of the application fee, while the Guidelines, Part C, Opposition, Section 1, Opposition Proceedings, deals with the consequences of late payment of the opposition fee.

#### 4.1.2 Evidence of payment and of the date of payment

[Article 180\(4\) EUTMR](#)

[Article 24 EUTMIR](#)

Article 63 CDR

Article 81(2) CDIR

Article 7(4) CDFR

Any means of evidence may be submitted, such as:

- a bank transfer order (e.g. SWIFT order) bearing stamps and the date of receipt from the bank involved;
- an online payment order sent via the internet or a printout of an electronic transfer, provided it contains information on the date of the transfer, on the bank it was sent to, and an indication such as 'transfer done'.

In addition, the following evidence may be submitted:

- acknowledgement of receipt of payment instructions by the bank;
- letters from the bank where the payment was effected, certifying the day on which the order was placed or the payment was made, and indicating the procedure for which it was made;
- statements from the party or its representative in writing, sworn or affirmed or having a similar effect under the law of the State in which the statement is drawn up.

This additional evidence is only considered sufficient if supported by the initial evidence.

This list is not exhaustive.

If the evidence is not clear, the Office will send a request for further evidence.

If no evidence is submitted, the procedure for which the payment was made is deemed not to have been entered.

In the event of insufficient proof, or if the payer fails to comply with the Office's request for the missing information, the latter will consider that the time limit for payment has not been observed.

The Office may likewise, within the same time limit, request the person to pay the surcharge. In the event of non-payment of the surcharge, the deadline for payment will be considered not to have been observed.

The fee or charges or the part thereof that have been paid will be reimbursed since the payment is invalid.

The documents may be filed in any official language of the EU. Where the language of the documents is not the language of the proceedings, the Office may require that a translation be supplied in any Office language.

## **4.2 Payment by debit or credit card**

Articles 16 and 17 of Decision No [EX-21-5](#) of the Executive Director of the Office of 21/07/2021 concerning methods of payment of fees and charges and determining the insignificant amount of fees and charges

Payment by credit or debit card is deemed to have been made on the date on which the related filing or request is successfully completed via the User Area and if the money actually reaches the Office's account as a consequence of the credit or debit card transaction, and is not withdrawn at a later date. If, when the Office attempts to debit the credit or debit card, the transaction fails for any reason, payment is considered not to have been made. This applies in all cases where the transaction fails.

## **4.3 Payment by current account**

Article 8 of Decision No [EX-21-5](#) of the Executive Director of the Office of 21/07/2021 concerning methods of payment of fees and charges and determining the insignificant amount of fees and charges

If the payment is made through a current account held with the Office, Decision No [EX-21-5](#) of the Executive Director of the Office of 21/07/2021 concerning methods of payment of fees and charges and determining the insignificant amount of fees and charges provides that the date on which the payment is deemed to be made is fixed in order to be convenient for the party to the proceedings. For example, for the application fee for an EUTM, the fees will be debited from the current account on the day of receipt of the application. However, the account holder may instruct the Office to debit its account on the last day of the one-month time limit provided for payment. Likewise,

upon renewal, the fees for renewal (including the class fees) are debited on the day of receipt of the request, unless the account holder requests otherwise.

If a party withdraws its action on the same day it was submitted, or before the end of the time limit to make the payment, the fee (where applicable) will not be debited from the current account. See paragraphs [5.1](#) and [5.6](#) below on the specific conditions for refund of application and renewal fees where payment is made by current account, and [Guidelines, Part A, Section 1, Means of Communication, paragraph 3.1.6, Withdrawal of submissions](#)).

## 5 Refund of Fees

[Article 108](#), [Article 179\(3\)](#) and [Article 181 EUTMR](#)

Articles 6(2) and 8(1) CDFR

Article 30(2) CDIR

The refund of fees is explicitly provided for in the Regulations. Refunds are given by means of bank transfer or through current accounts with the Office, even when the fees were paid by debit or credit card.

As a general rule, if a declaration that is subject to the payment of a fee has been withdrawn before or on the day the payment is deemed to have been made, the fee will be refunded.

Where a fee is to be refunded, the refund will be made to the party directly or to the representative on file (if one is appointed) at the time the refund is made. Refunds will not be made to the original payee where this person is no longer on file.

### 5.1 Refund of application fees

[Article 32](#) and [Article 49\(1\) EUTMR](#)

Articles 10, 13 and 22 CDIR

In the event of the withdrawal of an EUTM application, fees are not refunded except if a declaration of withdrawal reaches the Office:

- (in the case of payment by **bank transfer**) before or at the latest on the same day as the amount actually entered the bank account of the Office;
- (in the case of payment by debit or **credit card**) on the same day as the application containing the debit or credit card instructions/details;
- (in the case of payment by **current account**, and where the holder explicitly requested the application fee to be debited on the last day of the 1-month time limit provided for payment or, where later written instruction has been given to

immediately debit the current account within that month) before or at the latest on the same day on which the payment is due to be debited.

Where the basic application fee has to be refunded, any additional class fees paid will be refunded as well.

In all the above scenarios, a filing date will not be assigned to the EUTM application.

The Office will only refund additional class fees on their own where they have been paid in excess of the classes indicated by the applicant in the EUTM application and where such payment was not requested by the Office or where, upon examination of the classification, the Office concludes that additional classes have been included that were not required in order to cover the goods and services contained within the original application.

As regards **designs**, if a withdrawal is received before a filing date has been granted, any fees paid will be refunded. However, under no circumstances will the fees be refunded if the design applied for has been registered.

## 5.2 Refund of the opposition fee

Articles [5\(1\)](#), [6\(5\)](#) and [7\(1\)](#) EUTMDR

If an opposition is deemed not entered (because it was filed after the 3-month time limit), or if the opposition fee was not paid in full or was paid after the expiry of the opposition period, or if the Office refuses protection of the mark *ex officio* pursuant to [Article 45\(3\) EUTMR](#), the Office must refund the fee (see [Guidelines, Part C, Opposition, Section 1, Opposition Proceedings, paragraph 6.4, Fee refund](#)).

## 5.3 Refund of the fee for an application for revocation or for a declaration of invalidity

[Article 15\(1\) EUTMDR](#)

If an application for revocation or for declaration of invalidity is deemed not to have been entered because the fee was not paid within the period specified by the Office, the Office must refund the fee, including the surcharge (see [Guidelines, Part D, Cancellation, Section 1, Cancellation Proceedings, paragraph 2.3, Payment](#)).

## 5.4 Refund of fees for international marks

Decision No [ADM-11-98](#) of the President of the Office related to the regularisation of certain reimbursements of fees

For information on the different scenarios where a refund may be applicable in processes relating to international applications and registrations where the EUIPO is the office of origin and/or designated office, see the Guidelines, [Part M, International Marks](#).

## 5.5 Refund of appeal fees

[Article 33 EUTMDR](#)

Article 35(3) and Article 37 CDIR

Provisions regarding the refund of appeal fees are dealt with under [Article 33 EUTMDR](#) and Article 35(3) and Article 37 CDIR.

## 5.6 Refund of renewal fees

[Article 53\(8\) EUTMR](#)

Article 22(7) CDIR

Fees that are paid **before** the start of the first 6-month time limit for renewal will not be taken into consideration and will be refunded.

Where the fees have been paid, but the registration is not renewed (i.e. where the fee has been paid only after the expiry of the additional time limit, or where the fee paid amounts to less than the basic fee and the fee for late payment/late submission of the request for renewal, or where certain other deficiencies have not been remedied), the fees will be refunded.

Where the owner has filed a request for renewal of an EUTM and subsequently either totally or partially (in relation to some classes) withdraws the renewal request, the renewal fee will only be refunded:

- if, in the case of payment by **bank transfer**, the Office received the withdrawal before or at the latest on the same day as the amount actually entered the bank account of the Office;
- if, in the case of payment by **debit** or **credit card**, the Office received the withdrawal before or on the same day as receiving the debit or credit card payment;



- if, in the case of payment by **current account**, and where the holder explicitly requested the fee to be debited on the last day of the 6-month time limit provided for payment, and the Office received the withdrawal within the 6-month time limit for renewal or, where later written instruction was given to debit the current account immediately, before or at the latest on the same day that the payment is due to be debited.

For further information, see [the Guidelines, Part E, Register Operations, Section 4, Renewal](#).

## 5.7 Refund of insignificant amounts

### [Article 181 EUTMR](#)

Article 9(1) CDFR

Article 18 of Decision No [EX-21-5](#) of the Executive Director of the Office of 21/07/2021 concerning methods of payment of fees and charges and determining the insignificant amount of fees and charges

A fee will not be considered settled until it has been paid in full. If this is not the case, the amount already paid will be reimbursed after the expiry of the time limit allowed for payment, since in this case the fee no longer has any purpose.

However, insofar as it is possible, the Office may invite the person to complete payment within the time limit.

Where an excess sum is paid to cover a fee or a charge, the excess will not be refunded if the amount is insignificant and the party concerned has not expressly requested a refund. Insignificant amounts are fixed at EUR 15 by Decision No [EX-21-5](#) of the Executive Director of the Office of 21/07/2021 concerning methods of payment of fees and charges and determining the insignificant amount of fees and charges.

## 6 Fee Reduction for an EUTM Application Filed by Electronic Means

### [Annex I A\(2\) EUTMR](#)

Decision [No EX-20-9](#) of the Executive Director of the Office of 3 November 2020 on communication by electronic means

According to [Annex I A\(2\) EUTMR](#), the basic fee for an application for an individual mark may benefit from a reduction if the application has been filed by electronic means. The applicable rules and procedure for such an electronic filing may be found in Decision [No EX-20-9](#) of the Executive Director of the Office of 3 November 2020 on

communication by electronic means in conjunction with the [Conditions of Use of the User Area](#) as established in this decision.

In order to be considered an application for an EUTM filed by electronic means in the sense of [Annex I A\(2\) EUTMR](#), the applicant has to insert all the goods and/or services to be covered by the application directly into the Office tool. Consequently, the applicant must not include the goods and/or services in an annexed document or submit them by any other means of communication. If the goods and/or services are annexed in a document or submitted to the Office by any other means of communication, the application will not be considered as having been filed by electronic means and may not benefit from the corresponding fee reduction.

## 7 Decisions on Costs

[Article 109 EUTMR](#)

[Article 1\(k\)](#), Articles [18](#) and [27](#) EUTMIR

### 7.1 Fixing of costs

The decision fixing the amount of costs includes the lump sum provided in [Article 27 EUTMIR](#) for professional representation and fees (see above) incurred by the winning party, independently of whether they have actually been incurred. The fixing of the costs may be reviewed in specific proceedings pursuant to [Article 109\(7\) EUTMR](#).

### 7.2 Enforcement of the decision on costs

[Article 110 EUTMR](#)

The Office is not competent for enforcement procedures. These must be carried out by the competent national authorities.

#### 7.2.1 Conditions

The winning party may enforce the decision on costs, provided that:

- the decision contains a decision fixing the costs in their favour;
- the decision has become final;
- the decision bears the order of the competent national authority.

#### 7.2.2 National authority

Each Member State will designate a single national authority for the purpose of verifying the authenticity of the decision and for appending the order for the

enforcement of Office decisions fixing costs. The Member State must communicate its contact details to the Office, to the Court of Justice and to the Commission ([Article 110\(2\) EUTMR](#)).

The Office publishes such designations in its Official Journal.

### 7.2.3 Proceedings

1. The interested party must request the competent national authority to append the enforcement order to the decision. For the time being, the conditions on languages of the requests, translations of the relevant parts of the decision, fees and the need for a representative depend on the practice of the individual Member States and are not harmonised but are considered on a case-by-case basis.

The competent authority will append the order to the decision without any other formality beyond the verification of the authenticity of the decision. As to wrong decisions on costs or fixing of costs, see [paragraph 7.3](#) below.

2. If the formalities have been completed, the party concerned may proceed to enforcement. Enforcement is governed by the rules of civil procedure in force in the territory where it is carried out ([Article 110\(2\) EUTMR](#)). The enforcement may be suspended only by a decision of the Court of Justice of the European Union. However, the courts of the country concerned have jurisdiction over complaints that enforcement is being carried out in an irregular manner ([Article 110\(4\) EUTMR](#)).

## 7.3 Apportionment of costs

In *inter partes* proceedings, the Opposition Division, the Cancellation Division and the Boards of Appeal take, where necessary, a decision on the apportionment of costs. Those costs include in particular the costs of the professional representatives, if any, and the corresponding fees. For further information relating to the apportionment of costs in opposition proceedings, see the Guidelines, [Part C, Opposition, Section 1, Opposition Proceedings, paragraph 6.5, Decision on the apportionment of costs](#). Regarding cancellation proceedings, see the Guidelines, [Part D, Cancellation, Section 1, Cancellation Proceedings, paragraph 4.3.4, Decision on apportionment of costs](#). Where the decision contains obvious mistakes as regards the costs, the parties may ask for a corrigendum ([Article 102\(1\) EUTMR](#)) or a revocation ([Article 103 EUTMR](#)), depending on the circumstances (see the Guidelines, [Part A, General Rules, Section 6, Revocation of Decisions, Cancellation of Entries in the Register and Correction of Errors](#)).

***GUIDELINES FOR EXAMINATION***  
***EUROPEAN UNION***  
***INTELLECTUAL PROPERTY OFFICE***  
***(EUIPO)***

***Part A***

***General rules***

***Section 4***

***Language of proceedings***

## Table of Contents

<b>1 Introduction.....</b>	<b>71</b>
<b>2 From Filing to Registration (Excluding Opposition).....</b>	<b>71</b>
<b>3 Opposition and Cancellation.....</b>	<b>72</b>
<b>4 Design invalidity.....</b>	<b>72</b>
<b>5 Other Requests.....</b>	<b>73</b>
<b>5.1 Before registration (excluding opposition).....</b>	<b>73</b>
<b>5.2 After registration (excluding cancellation and design invalidity).....</b>	<b>74</b>
<b>6 Invariable Nature of the Language Rules.....</b>	<b>74</b>
<b>7 Translations and their Certification.....</b>	<b>75</b>
<b>8 Non-compliance with the Language Regime.....</b>	<b>75</b>

## 1 Introduction

[Article 146 EUTMR](#)

Articles [25](#) and [26](#) EUTMIR

[Article 24 EUTMIR](#)

Article 98 CDR

Articles 80, 81 and 83 CDIR

There are five Office languages: English, French, German, Italian and Spanish. However, an application for a European Union trade mark (EUTM) or registered Community design (RCD) may be filed in any of the official EU languages. The EUTMR and the CDR lay down rules for determining and using the language of proceedings. These rules may vary from one set of proceedings to another, in particular depending on whether the proceedings are *ex parte* or *inter partes*.

This section deals only with the horizontal provisions common to all types of proceedings. The exceptions for particular types of proceedings are dealt with in the corresponding sections of the Guidelines.

Pursuant to [Article 146\(6\) EUTMR](#) and Article 80(c) CDIR, when a request is filed using a form provided by the Office pursuant to [Article 65 EUTMDR](#) and Article 68 CDIR, the form may be used in any of the official languages of the European Union, provided that the form is completed in one of the languages of the Office, as far as textual elements are concerned.

## 2 From Filing to Registration (Excluding Opposition)

[Article 146 EUTMR](#)

Article 98 CDR

EUTM and RCD applications may be filed in any of the official EU languages (first language). The language of the proceedings will be the language used for filing the application.

A second language must be indicated from among the five languages of the Office.

The second language serves as a potential language for opposition, cancellation and design invalidity proceedings. The second language must be different from the language selected as the first language. The choice of first and second language cannot be changed once the application has been filed.

If the language that the applicant has selected as the first language is one of the five languages of the Office, then this will be used by the Office as the correspondence language.

This language regime applies throughout the application and examination procedure until registration, except for oppositions and ancillary requests (see following paragraphs).

For more information on the linguistic regime and translations for EUTM examination, including the possibility of changing the correspondence language, see the Guidelines, [Part B, Examination, Section 2, Formalities, paragraph 6](#).

### 3 Opposition and Cancellation

[Article 146\(5\), \(7\) and \(8\) EUTMR](#)

[Article 3 EUTMDR](#)

An opposition or request for cancellation (application for revocation or declaration of invalidity) may be filed:

- at the discretion of the opponent/applicant for cancellation in the first or second language of the EUTM application if the first language is one of the five languages of the Office;
- in the second language if the first language is not an Office language.

This language becomes the language of proceedings for the opposition or cancellation proceedings unless the parties agree to a different one (from among the official EU languages).

An opposition or request for cancellation may also be filed in any of the other Office languages, provided that within 1 month of expiry of the opposition period or within 1 month of filing the application for cancellation, the opponent/applicant for cancellation files a translation into a language that is available as a language of proceedings.

For more information on the linguistic regime and translations for supporting documents in opposition proceedings, see the Guidelines, [Part C, Opposition, Section 1, Opposition Proceedings, paragraphs 2.3](#) and [4.3](#), and for cancellation proceedings see the Guidelines, [Part D, Cancellation, Section 1, Proceedings, paragraphs 2.4](#) and [3.3](#).

### 4 Design invalidity

Article 98(4) and (5) CDR

Article 29 and Article 30(1) CDIR

An application for a declaration of invalidity may be filed:

- in the first language of the RCD if the first language is one of the five languages of the Office;
- in the second language if the first language is not an Office language.

This language becomes the language of proceedings for the invalidity proceedings.

The parties to the invalidity proceedings may agree on a different language of proceedings provided it is an official language of the European Union. Information about the agreement must reach the Office within 2 months of the official communication sent after the completion of the admissibility examination pursuant to Article 31(1) CDIR.

Where the application for a declaration of invalidity was not filed in that language, the applicant must, on its own motion, file a translation of the application in that language within 1 month of the date when the Office was informed of the agreement. If these legal requirements are not met, the language of proceedings will remain unchanged.

Where the application is not filed in the language of proceedings, the Invalidity Division will notify the applicant to file a translation within 2 months of the date of receipt of the notification. Where the applicant does not comply with the request, the application will be rejected as inadmissible.

For the linguistic regime applicable to the supporting documents filed in invalidity proceedings, see the Guidelines on Examination of Design Invalidation Applications, paragraph 3.10.2.

## **5 Other Requests**

### **5.1 Before registration (excluding opposition)**

[Article 146\(6\) EUTMR](#)

[Article 65 EUTMDR](#)

[Article 24 EUTMIR](#)

Article 68, Article 80(a) and (c), and Article 81 CDIR

Unless otherwise provided, during the period from filing to registration, any request, application or declaration that is not concerned with the examination of the application as such but that starts an ancillary procedure (e.g. restriction of the list of goods or services, registration of a transfer or licence, request for conversion, declaration of division for an EUTM or RCD) may be filed in the first or second language of the respective EUTM or RCD application, at the discretion of the applicant or third party. That language then becomes the language of proceedings for those ancillary proceedings. This applies irrespective of whether or not the first language is an Office language.



For example, where the first language of the EUTM application is Bulgarian, and the second language is German, a request for transfer of ownership of the EUTM application can be filed in either Bulgarian or German.

Supporting evidence (if needed) may be in any of the official EU languages. However, if it is not in the language of the proceedings, the Office may require a translation into the language of the proceedings or into a language of the Office (RCD proceedings only).

For more information on the linguistic regime and translations concerning Register operations please see the respective sections in [the Guidelines in Part E, Register Operations](#).

## **5.2 After registration (excluding cancellation and design invalidity)**

[Article 146\(6\) EUTMR](#)

[Article 65 EUTMDR](#)

[Article 24 EUTMIR](#)

Article 68 and Article 80(b) and (c), and Article 81 CDIR

Any request, application or declaration filed after the EUTM or RCD has been registered must be submitted in one of the five Office languages.

Furthermore, post-registration requests concerning the same registered EUTM or RCD do not necessarily have to be submitted in the same language. For example, after an EUTM has been registered, the EUTM proprietor may file a request for the registration of a licence in English and, a few weeks later, file a request for renewal in Italian and/or a transfer of ownership request in French. The only requirement is that the requests are submitted in one of the five Office languages.

Supporting evidence (if needed) may be in any of the official EU languages. However, if it is not in the language of the proceedings, the Office may require a translation into the language of the proceedings or into a language of the Office (RCD proceedings only).

For more information on the linguistic regime and translations concerning Register operations, please see the respective sections in [the Guidelines in Part E, Register Operations](#).

## **6 Invariable Nature of the Language Rules**

The Regulations allow certain choices to be made from among the available languages in the course of the proceedings (see above) and, during specified periods, a different language to be chosen as the language of proceedings for opposition, cancellation and design invalidity. However, with those exceptions, the language rules are invariable. In

particular, the first and second languages may not be amended in the course of the proceedings.

## 7 Translations and their Certification

[Article 146\(10\) EUTMR](#)

Articles [24 to 26](#) EUTMIR

Article 83 CDIR

The general rule is that where a translation of a document is required, it must reach the Office within the time limit set for filing the original document. This applies unless an exception to this rule is expressly provided in the Regulations.

The translation must identify the document to which it refers and reproduce the structure and contents of the original document. The party may indicate that only parts of the document are relevant and limit the translation to those parts. However, the party does not have discretion to consider irrelevant any parts that are required by the Regulations (for example, when proving the existence of an earlier trade mark registration in opposition proceedings).

In the absence of evidence or indications to the contrary, the Office will assume that a translation corresponds to the relevant original text. In the event of doubt, the Office may require the filing, within a specific period, of a certificate that the translation corresponds to the original text. If the required certificate is not submitted, the document for which the translation had to be filed will be deemed not to have been received by the Office.

## 8 Non-compliance with the Language Regime

If the language regime is not complied with, the Office will issue a deficiency letter, unless otherwise provided in the Regulations. Should the deficiency not be remedied, the application or the request will be refused.

For more information on language regimes for particular types of proceedings the corresponding sections of the Guidelines should be consulted.

***GUIDELINES FOR EXAMINATION***  
***EUROPEAN UNION***  
***INTELLECTUAL PROPERTY OFFICE***  
***(EUIPO)***

***Part A***

***General rules***

***Section 5***

***Parties to the Proceedings and Professional  
representation***

## Table of Contents

<b>1 Introduction - Parties to the Proceedings and Principle of Representation.....</b>	<b>79</b>
<b>2 Parties to proceedings before the Office.....</b>	<b>80</b>
<b>3 Identification of parties to the proceedings .....</b>	<b>81</b>
<b>3.1 Name.....</b>	<b>82</b>
3.1.1 Natural persons.....	82
3.1.2 Legal entities.....	82
<b>3.2 Address .....</b>	<b>83</b>
3.2.1 Legal address.....	83
3.2.2 Address for service.....	84
<b>3.3 Other contact details.....</b>	<b>84</b>
<b>4 Representatives: Who May Represent.....</b>	<b>84</b>
<b>4.1 ID numbers and database.....</b>	<b>85</b>
<b>4.2 Representation by legal practitioners.....</b>	<b>86</b>
4.2.1 The term 'legal practitioner'.....	86
4.2.2 Qualification.....	86
4.2.3 Nationality and place of business.....	86
4.2.4 Entitlement to act in trade mark and/or design matters.....	87
<b>4.3 Professional representatives admitted and entered on the lists maintained by the Office.....</b>	<b>88</b>
4.3.1 Entitlement under national law.....	89
4.3.1.1 First alternative - special professional qualifications.....	89
4.3.1.2 Second alternative - 5 years' experience.....	89
4.3.1.3 Third alternative - recognition by a Member State of the EEA.....	90
4.3.2 Nationality and place of business.....	90
4.3.3 Certificate.....	90
4.3.4 Exemptions.....	91
4.3.5 Procedure for entry on the list.....	93
4.3.6 Amendment of the list of professional representatives.....	94
4.3.6.1 Deletion.....	94
4.3.6.2 Suspension of the entry on the list.....	95
4.3.7 Reinstatement in the list of professional representatives.....	95
<b>4.4 Representation by an employee.....</b>	<b>95</b>

4.4.1 General considerations.....	95
4.4.2 Indirect employment.....	97
<b>4.5 Legal representation and signature.....</b>	<b>98</b>
<b>5 Appointment of a Professional Representative.....</b>	<b>99</b>
<b>5.1 Conditions under which appointment is mandatory.....</b>	<b>99</b>
5.1.1 Domicile, principal place of business, or real and effective industrial or commercial establishment.....	99
5.1.2 The notion of 'in the EEA'.....	100
<b>5.2 Consequences of non-compliance when appointment is mandatory.....</b>	<b>100</b>
5.2.1 During registration.....	100
5.2.2 During opposition.....	101
5.2.3 Cancellation.....	101
<b>5.3 Appointment of a representative when not mandatory.....</b>	<b>102</b>
<b>5.4 Appointment/replacement of a representative.....</b>	<b>102</b>
5.4.1 Explicit appointment/replacement.....	102
5.4.2 Implicit appointment.....	103
5.4.3 Associations of representatives.....	104
<b>6 Communication with Parties and Representatives.....</b>	<b>105</b>
<b>7 Authorisation.....</b>	<b>106</b>
7.1 Individual authorisations.....	107
7.2 General authorisations.....	107
7.3 Consequences where authorisation expressly requested by the Office is missing.....	108
<b>8 Withdrawal of a Representative's Appointment or Authorisation.....</b>	<b>108</b>
8.1 Action taken by the person represented.....	108
8.2 Withdrawal by the representative.....	109
<b>9 Death or Legal Incapacity of the Party Represented or     Representative.....</b>	<b>109</b>
9.1 Death or legal incapacity of the party represented.....	109
9.2 Death or legal incapacity of the representative.....	110
<b>10 Change of name and address.....</b>	<b>110</b>
<b>11 Correction of the name or address.....</b>	<b>111</b>
<b>Annex 1.....</b>	<b>113</b>
<b>Annex 2.....</b>	<b>136</b>

## 1 Introduction - Parties to the Proceedings and Principle of Representation

Articles [3](#), [5](#), [119](#) and [120](#) EUTMR

[Article 7\(b\) EUTMIR](#)

Articles 14, 52, 77 and 78 CDR

Article 62 CDIR

Any natural or legal person, including authorities established under public law, may be the proprietors of a European Union trade mark (EUTM) and, in general, may be parties to the proceedings before the Office. The only exceptions are certain limitations on the ownership of collective and certification marks (please see the Guidelines, [Part B, Section 4, Absolute grounds for refusal, Chapters 15](#) and [16](#), on collective and certification marks respectively).

In principle, the right to a registered Community design (RCD) will vest in the designer or its successor in title. However, a legal person may also hold a registered Community design and be party to the proceedings before the Office.

Companies or firms and other legal bodies shall be regarded as legal persons if, under the terms of the law governing them, they have the capacity in their own name to have rights and obligations of all kinds, to make contracts or accomplish other legal acts, and to sue and be sued.

Persons having their domicile or their principal place of business or a real and effective industrial or commercial establishment within the European Economic Area (EEA), which consists of the European Union (EU) and Iceland, Liechtenstein and Norway, are not required to be represented in any proceedings before the Office in either trade mark or design matters (see [paragraph 5.1.1](#) below).

Natural persons not domiciled in or legal persons that do not have their principal place of business or a real and effective industrial or commercial establishment in the EEA must be represented by a representative based within the EEA, unless appointment of a representative is not mandatory (see [paragraph 5.1](#) below for any exceptions to the general rule). See [paragraph 5.2.1](#) below on the consequences of not appointing a representative, when representation is mandatory, once the EUTM or RCD application has been filed.

Representatives in the sense of Articles [119](#) and [120](#) EUTMR must have a place of business or employment in the EEA.

As regards RCD proceedings, according to Articles 77 and 78 CDR, the relevant territory for establishing the obligation to be represented and the place where the representative must be based in the sense of Article 78 CDR is the EU. However, following the judgment in the *Paul Rosenich* case (13/07/2017, [T-527/14](#), PAUL ROSENICH, EU:T:2017:487), the Office deems the EEA to be the relevant territory,

with the result that the considerations previously applied to the EEA in trade mark matters also apply to designs.

In principle, representatives do not need to file an authorisation to act before the Office unless the Office expressly requires it, or where, in *inter partes* proceedings, the other party expressly requests it.

Where a representative has been appointed, the Office will communicate solely with that representative.

The first part of this section ([paragraphs 2](#) and [3](#)) deals with the identification of all parties to the proceedings before the Office.

The second part of this section ([paragraph 4](#)) sets out the different types of representatives.

The third part of this section ([paragraphs 5](#) to [9](#)) deals with the appointment of representatives or the failure to do so, and the authorisation of representatives.

The final part of this section ([paragraphs 10](#) and [11](#)) deals with changes and corrections in names and addresses of parties in pre-registration stages. For further information on changes in registrations, please see the Guidelines, [Part E, Section 1, Changes in a registration](#) and the Design Guidelines on [Examination of applications for registered Community designs, paragraph 11](#).

## 2 Parties to proceedings before the Office

### [Article 112\(1\) EUTMR](#)

Article 7 of Decision No [EX-21-4](#) of the Executive Director of the Office of 30 March 2021 on the Register of EU trade marks, Register of Community designs, the database of proceedings before the Office, and on the case-law database.

This section of the Guidelines deals with the general provisions on parties to the proceedings. For information on the parties' entitlements in the different procedures before the Office, please see the rules in the relevant sections of these Guidelines. For example, for further information on:

- persons entitled to own EUTM Collective marks and EUTM certification marks, see [the Guidelines, Part B, Section 4, Absolute Grounds for Refusal, Chapter 15 Collective Marks, Paragraph 2](#); and [the Guidelines, Part B, Chapter 16 Certification marks, Paragraph 4](#);
- specific aspects of persons entitled to file an opposition, see [the Guidelines, Part C, Section 1, Opposition Proceedings, Paragraph 2.4.2.6](#);
- specific aspects of persons entitled to file an application for cancellation, see [the Guidelines, Part D, Section 1 Proceedings, Paragraph 2.1](#);
- specific aspects of persons entitled to file an application for international application based on an EUTM (EUIPO as Office of origin), see [the Guidelines, Part M, International Marks, Paragraph 2.1.3.1](#);

- specific aspects of persons entitled to file an application for the declaration of invalidity of a RCD, see [the Guidelines, Examination of Design Invalidity Applications, Paragraph 3.5](#);

All persons that identify themselves as parties to proceedings before the Office are entered into the Office's database and are allocated an identification (ID) number. The ID number can be viewed in [the Office's eSearch plus tool](#) available on the Office's website.

The Office encourages parties to always use their ID number to import existing details instead of manually inserting the address and/or any other contact details on any form or in any communication to the Office as this leads to less errors. However, the ID number cannot replace the party's name where it needs to appear on any form or communication.

### **3 Identification of parties to the proceedings**

#### [Article 3 EUTMR](#)

#### [Article 2\(1\)\(b\) EUTMIR](#)

#### Article 1(1)(b) CDIR

Decision No [EX-21-4](#) of the Executive Director of the Office of 30 March 2021 on the Register of EU trade marks, the Register of Community Designs, the database of proceedings before the Office, and on the case-law database.

EUTM and RCD applicants are identified pursuant to the criteria laid down in [Article 2\(1\)\(b\) EUTMIR](#) and Article 1(1)(b) CDIR respectively. This criteria applies, *mutatis mutandis*, to all parties to proceedings before the Office (e.g. opponents, applicants for revocation or for a declaration of invalidity, applicants for registration of a transfer).

The information required to identify a party is:

- name;
- address;
- the country of domicile if a natural person, or the country in which it is domiciled or has its seat or an establishment if a legal entity.

In an application for an RCD, natural persons must also indicate their nationality.

If the party to the proceedings has previously been allocated an ID number by the Office, it is sufficient to indicate the ID number and the party's name.

Where there are multiple parties to the proceedings, the same identification requirements are required for each one of them.

All of the data identified in the following paragraphs, i.e. [3.1 Name](#), [3.2 Address](#) and [3.3 Other contact details](#), will be kept in the database indefinitely (pursuant to [Article 112\(5\) EUTMR](#) and Articles 7(2) and 10(2) and (3) of Decision No [EX-21-4](#)). However, the party concerned can request the removal of any personal data from the database



18 months after the expiry of the EUTM, RCD or international trade mark designating the EU, or the closure of the relevant *inter partes* procedure.

Where the name and legal address of a party, or their professional representative, are recorded in the EUTM or RCD Registers, they will be kept indefinitely (pursuant to [Article 111\(9\) EUTMR](#), Article 69 CDIR, and Article 3(8) Decision No [EX-21-4](#)). For information on what data appears in the EUTM and RCD Registers, please see Annex I and II of Decision No [EX-21-4](#).

## 3.1 Name

### 3.1.1 Natural persons

Names of **natural persons** must include the person's first name(s) and surname(s) as they appear in official personal identification documents (example: John Steven Smith instead of J.S.Smith).

Where the name provided appears to be that of a physical person but the party has indicated that they are a 'legal entity' and filled in the legal form section with an indication which is not a legal form as such (such as free professional, freelance, sole proprietorship, etc.), the Office will send a notification of a deficiency. If the applicant fails to reply, the Office will change the type of person from 'legal entity' to 'natural person'.

For example, 'John Smith', identified as being a legal entity with the legal form 'freelance', will be changed to a natural person and the legal form deleted.

A natural person may provide any business or trading name as an optional indication in addition to their legal name. For example, natural person 'John Smith trading as Smithy's' is acceptable. See paragraph [3.1.2](#) for more information on the use of business or trading names.

### 3.1.2 Legal entities

Names of **legal entities** must be indicated by their official designation (full statutory name) and include the legal form of the entity (if applicable), which may be abbreviated in a customary manner (for example, S.L., S.A., Ltd, PLC). The company's national identification number may also be specified.

Legal entities may provide their business or trading names as an optional indication **in addition to** their official designation (typically indicated by using the legal name followed by 'trading as' or 'acting as' in the title). However, business or trading names must not be used alone, that is to say **instead of** the name of the legal entity. As a general rule, the Office will assume that applicants identified through mere business or trading names without any legal form are not entitled to own property in their own name unless evidence is submitted to the contrary.

For example, 'J. Smith Ltd trading as Smithy's' would be acceptable where 'J. Smith' is the legal name, 'Ltd' is the legal form, and 'Smithy's' is the trading name. Using the same example, 'Smithy's' by itself (with no legal form), will be objected to. See also the example under [paragraph 3.1.1](#).

The name of a legal entity in the process of being founded will be accepted.

The Office strongly recommends indicating the state of incorporation for companies based in the United States of America, where applicable, in order to differentiate clearly between different owners in its database.

If the legal form is not specified or is incorrectly indicated, a deficiency letter requesting this information will be issued. If the deficiency is not remedied the respective request will be rejected as the party cannot be correctly identified pursuant to [Article 2\(1\)\(b\) EUTMIR](#) and Article 1(1)(b) CDIR.

## **3.2 Address**

The Office recognises two types of address referred to in [Article 2\(1\)\(b\) EUTMIR](#) and Article 1(1)(b) CDIR: the official 'legal' address of a party and the 'address for service'.

Only one legal address should be indicated for each applicant. Where several addresses are indicated, the Office will only take into account the address that is mentioned first, except where the applicant designates one of the addresses as an address for service.

### **3.2.1 Legal address**

This is the address where the party has its domicile, principal place of business or real and effective industrial or commercial establishment. It is a compulsory requirement for identification. Furthermore the legal address is necessary for the Office to establish if the party needs to be represented or not pursuant to [Article 119\(2\) EUTMR](#) and Article 77(2) CDR.

For legal persons, the legal address is understood to be where the party has its seat, which is the company's registered headquarters or registered head office as appearing on the extract of the company register.

The address must contain all the identification elements required. This normally consists of the street name, street number, city/town, state/county/province and country, since without such details it is not possible to clearly identify the party.

If any of these particulars is missing, the Office will issue a deficiency and set a time limit by which to remedy the deficiency or to provide a valid reason for omitting it.

A post office box or a forwarding (virtual) address on its own does not constitute a legal address unless it can be proven that it is indeed registered as the company's address (e.g. by submitting an extract of the company register).

### 3.2.2 Address for service

An address for service (also referred to as a correspondence address) is an optional second address a party can provide. The Office will send any post to that address.

By default any correspondence by post will be addressed to the party's legal address unless a different address for service is provided.

### 3.3 Other contact details

It is not compulsory to provide additional contact details, such as telephone numbers or email addresses. However, providing an email address is recommended to facilitate setting up a user account.

## 4 Representatives: Who May Represent

[Article 119\(3\)](#) and [Article 120\(1\)\(a\) and \(b\) EUTMR](#)

[Article 74\(8\) EUTMDR](#)

Article 77(3) and Article 78(1)(a) and (b) CDR

Article 62(9) CDIR

In all Member States of the EEA, representation in legal proceedings is a regulated profession and may only be exercised under particular conditions. In proceedings before the Office, the following categories of representative are distinguished.

**Legal practitioners** ([Article 120\(1\)\(a\) EUTMR](#) and Article 78(1)(a) CDR) are professionals who, depending on the national law, are fully entitled to represent third parties before national offices (see [paragraph 4.2](#) below).

**Other professionals** ([Article 120\(1\)\(b\) EUTMR](#) and Article 78(1)(b) CDR) need to comply with further conditions and need to be included on a specific list maintained by the Office for this purpose (the Office's list of professional representatives). Amongst these, two further groups need to be distinguished: those who may represent only in RCD proceedings ('designs list') and those who may represent in both EUTM and RCD proceedings (see [paragraph 4.3](#) below). The Office refers to these other professionals collectively as '**professional representatives**'.

Several legal practitioners and professional representatives may be organised in entities called '**associations of representatives**' ([Article 74\(8\) EUTMDR](#); Article 62(9) CDIR) (see [paragraph 5.4.3](#) below).

The final category of representatives is made up of **employees** acting as representatives for the party to proceedings before the Office ([Article 119\(3\) EUTMR](#), first alternative; Article 77(3) CDR, first alternative) or employees of **economically**

**linked** legal persons ([Article 119\(3\) EUTMR](#), second alternative; Article 77(3) CDR, second alternative) (see [paragraph 4.4](#) below).

Employees are to be distinguished from **legal representatives** under national law (see [paragraph 4.5](#) below).

## 4.1 ID numbers and database

All persons that identify themselves as representatives for or employees of individual parties to proceedings before the Office and that fulfil the requirements provided by the regulations are entered into the database and obtain an ID number. The database has a double function, providing all relevant contact details under the specific ID number for any type of representative as well as the public information on the Office's list of professional representatives or designs list.<sup>(1)</sup>

A representative may have several IDs.

- Associations of representatives may have different IDs for different legal addresses.
- Individual representatives may have one ID as an employee representative and a different ID as a legal practitioner in their own right.
- If a person confirms that they work for two different associations of representatives or from two different addresses, they can have two different numbers attributed. Only the first ID number will be published in the Official Journal.
- It is also possible to have two different IDs, one as a legal practitioner and one as an Office professional representative where such a dual qualification is allowed under national law (which is not the case, for example, in France, see [Annex I](#) ). The Office, almost invariably refuses requests from legal practitioners to be entered on the list of Office professional representatives, as they are automatically entitled to appear in the database as 'legal practitioners' in their own right and do not need to be admitted onto the Office's list of professional representatives.

Where an ID is requested for any type of representative, the Office may require the person to prove the real and effective nature of their establishment at the address(es) identified. Any evidence submitted should not be limited to the mere existence of premises at these addresses but should prove real and effective business or employment being carried out and invoiced from the different locations.

An ID will not be granted for a post office box or a simple address for service in the EEA. See [paragraph 3.2](#) for the difference between the 'legal address' and the 'address for service'.

In the database, representatives are identified as: association, employee, lawyer (legal practitioners), and professional representative. Internally, the latter category is divided into two subcategories: type 1 consists of persons exclusively entitled to represent in RCD matters under Article 78(1)(c) CDR, and type 2 consists of persons entitled to

---

<sup>1</sup> Regarding the processing of mandatory personal data in relation to the tasks of the Office, which includes contact details, see EUIPO's explanatory note on the processing of personal data within the framework of the EUIPO's tasks as laid down in the EUTMR and CDR, accessible in the 'Data Protection' section of the Office's website.

represent in both trade mark and design matters under [Article 120\(1\)\(b\) EUTMR](#) and Article 78(1)(b) CDR.

On any form and in any communication sent to the Office, the representative's address and contact details may, and preferably should, be replaced by the ID number attributed by the Office, together with the representative's name.

The ID number can be found by consulting any of the files of the representative in question, or in the [advanced search options of the Office's eSearch plus tool](#) available on the Office's website: <https://euipo.europa.eu/eSearch/#advanced/representatives>.

## 4.2 Representation by legal practitioners

[Article 120\(1\)\(a\) EUTMR](#)

Article 78(1)(a) CDR

A legal practitioner is a professional who is automatically and without any further formal recognition allowed to represent third parties before the Office provided that they meet the following three conditions:

1. they must be qualified in one of the Member States of the EEA;
2. they must have their place of business within the EEA; and
3. they must be entitled, within the Member State in which they are qualified, to act as a representative in trade mark and/or design matters.

### 4.2.1 The term 'legal practitioner'

The professional titles for each EEA Member State are identified in the column 'Terminology for legal practitioner' in [Annex 1](#) of this Section.

### 4.2.2 Qualification

The requirement to be qualified in one of the Member States of the EEA means that the person must be admitted to the bar or be admitted to practise under one of the professional titles identified in [Annex 1](#) pursuant to the relevant national rules. The Office will not verify this unless there are doubts in this regard.

### 4.2.3 Nationality and place of business

There is no requirement as to nationality. Therefore, the legal practitioner may be a national of a state other than one of the Member States of the EEA.

The place of business must be in the EEA. A post office box address or an address for service does not constitute a place of business (see [paragraph 3.2.1](#), above, regarding the legal address). The place of business need not necessarily be the only place of business of the representative. Furthermore, the place of business may be in a

Member State of the EEA other than the one in which the legal practitioner is admitted to the bar. However, legal practitioners who have their sole place of business outside the EEA are not entitled to represent before the Office even when they are admitted to practise in one of the Member States of the EEA. The Office may at any time require evidence that the address provided is, or continues to be, a real and effective place of business.

Where an association of representatives, such as a law firm or a law office, has several places of business, it may perform acts of representation only under a place of business within the EEA, and the Office will only communicate with the legal practitioner at an address within the EEA.

#### 4.2.4 Entitlement to act in trade mark and/or design matters

The entitlement to act as a representative in trade mark and/or design matters in a state must include the entitlement to represent clients before the national industrial property office of that state. This condition applies to all Member States of the EEA.

Legal practitioners referred to in [Article 120\(1\)\(a\) EUTMR](#) and Article 78(1)(a) CDR who fulfil the conditions laid down in this Article are automatically entitled as of right to represent their clients before the Office. This basically means that if a legal practitioner is entitled to act in trade mark and/or design matters before the central industrial property office of the Member State of the EEA in which they are qualified, they will also be able to act before the Office.

Legal practitioners are not entered on the list of professional representatives to which [Article 120\(2\) EUTMR](#) and Article 78(1)(b) and (c) CDR refer, because the entitlement and the special professional qualifications referred to in those provisions relate to persons belonging to categories of professional representatives specialising in industrial property or trade mark matters, whereas legal practitioners are by definition entitled to be representatives in all legal matters.

If a 'legal practitioner' who has already been attributed an identification number as a legal practitioner requests entry on the list of 'professional representatives', the ID number will be maintained but the status will be changed from 'legal practitioner' to 'professional representative' following prior consultation with the applicant. Please refer to [paragraph 4.1](#) above concerning the situations where multiple ID numbers may be allocated to one person.

[Annex 1](#) gives a detailed explanation of the specific rules and terminology for most of the countries. The information contained in this Annex has been provided by the national industrial property office of each State, and any clarifications as regards its accuracy should therefore be addressed to the national industrial property office in question. The Office would appreciate being informed of any inconsistencies.

### 4.3 Professional representatives admitted and entered on the lists maintained by the Office

[Article 120\(1\)\(b\)](#) and [Article 120\(2\) EUTMR](#)

Article 78(1)(b) and (c) CDR

The second group of persons entitled to represent third parties professionally before the Office are those persons whose names appear on one of the two lists of professional representatives maintained by the Office:

1. the Office's list of professional representatives according to [Article 120\(1\)\(b\) EUTMR](#) and Article 78(1)(b) CDR (in trade mark and design matters);
2. the list of professional representatives according to Article 78(1)(c) CDR (in design matters).

For this category of professional representatives, the entry on the Office's list of professional representatives entitles them to represent third parties before the Office. A representative who is entered on the Office's list of professional representatives, referred to in [Article 120\(1\)\(b\) EUTMR](#), is automatically entitled to represent third parties in design matters according to Article 78(1)(b) CDR and will not be entered on the special list of professional representatives in design matters ('designs list').

If a person on the list maintained under [Article 120\(1\)\(b\) EUTMR](#) requests entry on the designs list maintained for professional representatives authorised to act exclusively in Community design matters under Article 78(1)(c) and (4) CDR, the request will be rejected.

The designs list is intended only for professional representatives who are entitled to represent clients before the Office in design matters but not trade mark matters.

[Annex 2](#) gives a detailed explanation of the specific rules and terminology for most of the countries. The information contained in this Annex has been provided by the national industrial property office of each State, and any clarifications as regards its accuracy should therefore be addressed to the national industrial property office in question. The Office would appreciate being informed of any inconsistencies.

Entry on the lists is subject to a request being completed and signed individually by the person concerned, using the form established for this purpose by the Office (which can be accessed online at: <https://euipo.europa.eu/ohimportal/en/forms-and-filings>).

In order to be entered on the list, three requirements must be fulfilled.

1. The representative must be a national of one of the Member States of the EEA.
2. They must have their place of business within the EEA.
3. They must be entitled under national law to represent third parties in trade mark or design matters before the national industrial property office. To that end they must provide a certificate attesting this from the national industrial property office of a Member State of the EEA.



#### 4.3.1 Entitlement under national law

The conditions for entry on the Office's list of professional representatives and the designs list depend on the legal situation in the Member State of the EEA concerned.

[Article 120\(2\)\(c\) EUTMR](#)

Article 78(1)(b) CDR

In a large number of Member States of the EEA, entitlement to represent third parties before the national office in trade mark matters is conditional upon possession of a special professional qualification ([Article 120\(2\)\(c\) EUTMR](#), first alternative; Article 78(4)(c) CDR, first alternative). Therefore, in order to be entitled to act as a representative, the person must have the required qualification.

In other Member States of the EEA, there is no such requirement for a special qualification, that is to say, representation in trade mark matters is open to anybody. In this case, the person involved must have regularly represented third parties in trade mark or design matters before the national office concerned for at least 5 years ([Article 120\(2\)\(c\) EUTMR](#), second alternative; Article 78(4)(c) CDR, second alternative). A subcategory of this category of Member States of the EEA consists of those States that have a system officially recognising a professional qualification to represent third parties before the national office concerned even though such recognition is not a prerequisite for the exercise of professional representation. In this case, persons so recognised are not subject to the requirement of having regularly acted as a representative for at least 5 years.

Please refer to [Annex 1](#) for the countries where special professional qualifications are required.

##### 4.3.1.1 First alternative - special professional qualifications

Where, in the Member State of the EEA concerned, entitlement is conditional upon having special professional qualifications, persons applying to be entered on the list must have acquired this special professional qualification.

##### 4.3.1.2 Second alternative - 5 years' experience

Where, in the Member State of the EEA concerned, the entitlement is not conditional upon possession of special professional qualifications, that is to say, representation in trade mark matters is open to anybody, persons applying to be entered on the list must have regularly acted as professional representatives in trade mark or design matters for at least 5 years before a central industrial property office of a Member State of the EEA.

It is possible for the Executive Director of the Office to grant an exemption from this requirement (see [paragraph 4.3.4](#) below).



#### 4.3.1.3 Third alternative - recognition by a Member State of the EEA

Where, in the EEA Member State concerned, the entitlement is not conditional upon possession of special professional qualifications, that is to say, representation in trade mark matters is open to anybody, persons whose professional qualification to represent natural or legal persons in trade mark and/or design matters before the central industrial property office of one of the Member States of the EEA is officially recognised in accordance with the regulations laid down by that State will not be subject to the condition of having exercised the profession for at least 5 years.

#### 4.3.2 Nationality and place of business

[Article 120\(2\) and \(4\) EUTMR](#)

Articles 78(4) and 78(6) CDR

A professional representative requesting to be entered on the list must be a national of a Member State of the EEA.

It is possible for the Executive Director of the Office to grant an exemption from the nationality requirement (see [paragraph 4.3.4](#) below).

A professional representative requesting to be entered on the list must have his or her place of business or employment in the EEA. A post office box address or an address for service does not constitute a place of business. The place of business or employment need not necessarily be the only place of business or employment of the representative. The Office may at any time require evidence that the address provided is, or continues to be, a real and effective place of business or employment.

#### 4.3.3 Certificate

[Article 120\(3\) EUTMR](#)

Article 78(5) CDR

Fulfilment of the abovementioned conditions laid down in [Article 120\(2\) EUTMR](#) and Article 78(4) CDR must be attested by a certificate provided by the national office concerned. Some national offices issue individual certificates while others provide the Office with block certificates.

Where block certificates are issued, the national offices send regularly updated lists of professional representatives entitled to represent clients before their office. In these cases the Office will check the indications in the request against the entries on the lists communicated to the Office.

Otherwise, the person concerned must accompany his or her request with an individual certificate. The applicant must complete the application form (which can be accessed online at <https://euipo.europa.eu/ohimportal/en/forms-and-filings>) and send it to the

respective industrial property office of the Member State concerned. The certificate must be completed by the respective industrial property office.

#### 4.3.4 Exemptions

##### [Article 120\(4\) EUTMR](#)

##### Article 78(6) CDR

The Executive Director of the Office may, under special circumstances, grant exemption from the requirement to be a national of an EEA Member State, provided that the professional representative demonstrates that he or she is a 'highly qualified professional'. He may also grant an exemption from the requirement of having regularly represented in trade mark matters for at least 5 years, provided that the professional representative demonstrates that he or she has acquired the required qualification in another way. This power is of a discretionary nature.

The broad discretionary power to grant exemptions from the 5 years' experience requirement or from EEA nationality requirement pursuant to [Article 120\(4\) EUTMR](#) and Article 78(4) CDR will be exercised by the Executive Director of the Office with due regard to the fact that the provision (i) does not confer any right to the person requesting the exemptions, (ii) is conceived as an exception from the general rule, which needs to be applied restrictively and on a strictly individual basis only, and (iii) can also be based on more general considerations such as the absence of any need for additional professional representatives.

##### 1. Exemptions from the 5 years' experience requirement

Exemptions from the requirement for 5 years' experience are limited to cases where the qualification to act as a representative in trade mark or design matters, has not been achieved before the central industrial property office concerned, but rather was acquired in another way, for the equivalent period of at least 5 years.

It should be noted that such exemption can only be requested where the requester is entitled to act in EEA Member States in which no 'special professional qualification' is required.

It should also be noted that the experience equivalent to at least 5 years of habitually acting as a representative before the central industrial property office concerned, to be established by the requester (with supporting evidence), must have been obtained in the EEA Member State concerned. For example, if an exemption is requested from the 5 year requirement to act before the central industrial property office of Member State 'A' (e.g. Malta), the evidence of habitually acting as a representative must emanate from that same Member State (Malta), and not from another EEA Member State (e.g. Ireland).

##### 2. Exemptions from the EEA nationality requirement

Exemptions from the EEA nationality requirement are limited to requesters that already comply with the requirements of [Article 120\(2\)\(b\) and \(c\) EUTMR](#), namely they have their place of business in the EEA, and they are entitled under national law to represent third parties before the national industrial property office.

In addition, it should be noted that exemptions from the EEA nationality requirement are only conceivable for a 'highly qualified professional', that is in exceptional circumstances.

This legal condition of being a 'highly qualified professional' would at least, and without being necessarily sufficient in themselves, require the requester to demonstrate (with supporting evidence) that his or her professional experience:

- is specifically related to trade mark and design matters,
- has been specifically obtained 'acting as a representative' in trade mark and/or design matters,
- is attributable to a specific trade mark and/or design portfolio, including elements such as the relevance of the IP rights managed, such as prominent cases and those that are proved to be difficult or standout due to the complexity of the subject or grounds tackled,
- has been performed under his or her own responsibility and authority,
- has been acquired exercising his or her national entitlement to represent others in trade mark or design matters before the national office in relation to which the requester holds that entitlement within the meaning of [Article 120\(2\)\(c\) EUTMR](#),
- exceeds the minimum requirement of 5 years' duration laid down in [Article 120\(2\)\(c\) EUTMR](#) if the entitlement to represent is based on experience and not on qualification.

The following circumstances would, on their own, not be considered to demonstrate that the requester is a 'highly qualified professional' for the purposes of the exemption from the EEA nationality requirement. However, provided that the aforementioned requirements are fulfilled, these could be considered in the overall assessment of all relevant factors:

- experience in IP-related areas of laws other than trade marks and designs (e.g. patents, copyright, etc.);
- formal qualifications (i.e. Trade Mark Attorney, European Patent Attorney, etc.);
- experience achieved under supervision, assisted by others, as part of a team, etc.
- publications, research or articles in recognised peer-reviewed journals or specialised publications, book authorship, experience in IP educational field.

Any request for exemption, which is not subject to any time limit, should be filed using the form provided for this purpose available on the Office's website. All the arguments and evidence the requester deems necessary to support the claims must

be filed together with that request. The Office will decide on the basis of that request.

That decision might be appealed before the General Court of the European Union under the conditions laid down in [Article 263\(4\) TFEU](#).

As regards exemptions from the nationality requirement for professional representatives in design matters, Article 78(6)(a) CDR does not refer to the requirement of a 'highly qualified professional'. Instead it requires the existence of 'special circumstances'.

However, the broad notion of 'special circumstances' does not preclude that the applicant must show that he or she is a 'highly qualified professional' in order to be exempted from the EEA nationality requirement for the purposes of the decision to be taken pursuant to Article 78(6)(a) CDR. The 'special circumstances' of the latter provision encompass the requirement of being a 'highly qualified professional'.

#### 4.3.5 Procedure for entry on the list

Articles [66\(1\)](#) and [120\(3\)](#) EUTMR, [Article 162 EUTMR](#)

Article 78(5) CDR

Entry on the list is confirmed by notification of a positive decision, which contains the indication of the ID number attributed to the professional representative. Entries on the Office's list of professional representatives or designs list are published in the Official Journal of the Office.

If any of the requirements for entry on the list of professional representatives are not fulfilled, a deficiency will be notified. If the deficiency is not remedied, the request for entry on the list will be rejected. The party concerned may file an appeal against this decision ([Article 66\(1\)](#) and [Article 162 EUTMR](#); Article 55(1) CDR).

Professional representatives may obtain an additional copy of the decision free of charge.

The files relating to requests for entry on the Office's list of professional representatives or designs list are not open to public inspection. Where a request for entry on the list of professional representatives is accompanied by a request for exemption because one of the necessary conditions for entry on the list is missing (see [paragraph 4.3.4](#) above), where the granting of that exemption has been refused by a final decision of the Executive Director, there will be no subsequent decision refusing entry on the list of representatives. This formal subsequent decision will only be issued where the requester explicitly requests it.

#### 4.3.6 Amendment of the list of professional representatives

##### 4.3.6.1 Deletion

###### First alternative — upon own request

[Article 120\(5\) EUTMR](#)

Article 78(7) CDR

Article 64(1) and (6) CDIR

The entry of a professional representative on the Office's list of professional representatives or designs list will be deleted at the request of that representative.

The deletion will be entered in the files kept by the Office. The notification of deletion will be sent to the representative and the deletion will be published in the Official Journal of the Office.

###### Second alternative — automatic deletion from the list of professional representatives

[Article 75\(1\) EUTMDR](#)

Article 64(2) and (5) CDIR

The entry of a professional representative in the Office's list of professional representatives or designs list will be deleted automatically:

1. in the event of the death or legal incapacity of the professional representative;
2. where the professional representative is no longer a national of a Member State of the EEA;
3. where the professional representative no longer has a place of business or employment in the EEA; or
4. where the professional representative is no longer entitled to represent third parties before the central industrial property office of a Member State of the EEA.

Where a professional representative changes from a design attorney to a trade mark attorney, he or she will be removed from the designs list and entered on the Office's list of professional representatives.

The Office may be informed of the above events in a number of ways. In case of doubt, the Office will, prior to deletion from the list, seek clarification from the national office concerned. It will also hear the professional representative, in particular where it is possible that he or she may be entitled to remain on the list on another legal or factual basis.

The deletion will be entered in the files kept by the Office. The decision of the deletion will be notified to the representative and the deletion will be published in the Official Journal of the Office.

#### 4.3.6.2 Suspension of the entry on the list

[Article 75\(2\) EUTMDR](#)

Article 64(3) CDIR

Upon notification by the relevant national industrial property office of a decision on the suspension of the entitlement to represent natural or legal persons before the respective national industrial property office, the entry of the professional representative on the Office's list of professional representatives or designs list will be suspended. The representative will be informed accordingly.

#### 4.3.7 Reinstatement in the list of professional representatives

[Article 75\(3\) EUTMDR](#)

Article 64(4) CDIR

A person whose entry has been deleted or suspended will, upon request, be reinstated in the list of professional representatives if the conditions for deletion or suspension no longer exist.

A new request must be submitted in accordance with the normal procedure for obtaining an entry on the list of professional representatives (see [paragraph 4.2](#) above).

### 4.4 Representation by an employee

[Article 119\(3\) EUTMR](#)

Articles [1\(j\)](#) and [74\(1\)](#), [Article 65\(1\)\(i\) EUTMDR](#)

Article 77(3) CDR

Article 62(2) and Article 68(1)(i) CDIR

#### 4.4.1 General considerations

A party to the proceedings before the Office, whether a natural or a legal person, having their domicile or principal place of business, or a real and effective industrial or commercial establishment in the EEA, may be represented before the Office by an employee ([Article 119\(3\) EUTMR](#), first sentence and Article 77(3) CDR, first sentence).

Employees of the legal persons described above may also represent other legal persons which have economic connections with the first legal person, even if those other legal persons do not have their legal address within the EEA ([Article 119\(3\) EUTMR](#), second sentence and Article 77(3) CDR, second sentence).

The acceptability of an employee representative therefore depends on whether the represented party is a natural or a legal person, whether the represented party has its legal address within or outside the EEA, and whether the employee is employed directly or indirectly by the represented party, as explained below.

For the definition of legal address, as identified in the represented persons ID number, see [paragraph 3.2.1](#).

The following situations can therefore be differentiated:

- Natural persons whose legal address is within the EEA may be represented by an employee employed by them. The employee may or may not work from the represented natural person's legal address, but the employee must be employed by this natural person. For example, the employee may work from a place of business that is different from the legal address of the natural person.
- Natural persons whose legal address is outside the EEA cannot be represented by an employee.
- Legal persons whose legal address is within the EEA may be represented by an employee directly employed by them. This means the employee may work directly for them at this legal address. It may, however, also be employed by them indirectly. This 'indirect' employee can either work for the represented legal person through another place of business or another real and effective establishment owned by them under a different address within the EEA; or be employed by another legal person within the EEA which is economically linked to the first legal person.
- Legal persons whose legal address is outside the EEA may only be represented by an 'indirect' employee, through an employee working for the represented legal person through another place of business or real and effective establishment owned by them under a different address within the EEA, or be employed by another legal person within the EEA which is economically linked to the first legal person. Regarding the requirements of indirect employee representation see below [paragraph 4.4.2](#).

For all these situations the employee representative must be a natural person and be located in the EEA. An employee located outside the EEA may not represent their employer before the Office.

On the forms made available by the Office, the employee signing the application or request must fill in the field reserved for representatives by indicating his or her name, address (of employment) and select the checkboxes relating to employee representative.

The name(s) of the employee(s) will be entered in the database and published under 'representatives' in the EUTM and RCD Bulletins and in the Office's database accessible through the eSearch plus tool. However, they will not be entered in the respective EUTM and RCD Registers.

Where employees act for their employer, this is not a case of professional representation under [Article 120\(1\) EUTMR](#) or Article 78(1) CDR. As such, [Article 109\(1\) EUTMR](#) and Article 79(7)(c), (d) and (f) CDIR are not applicable for the



apportionment and fixing of costs in *inter partes* proceedings (17/07/2012, [T-240/11](#), MyBeauty (fig.) / BEAUTY TV et al., EU:T:2012:391, § 15 *et seq.*).

In EUTM matters, no authorisation needs to be submitted, unless the Office or any party to the proceedings requests it. However, in RCD matters, Article 77(3) CDR sets down that a signed authorisation is a compulsory requirement for insertion in the file. No other requirements, for example that the employees be qualified to represent third parties before national offices, need be met.

The Office will verify the first time an employee representative claims to represent an employer. At a later stage it may also do so where it has reason to doubt that the employment relationship continues to exist, such as when different addresses are indicated or when one and the same person is nominated as the employee of different legal persons.

#### 4.4.2 Indirect employment

As outlined in [paragraph 4.4.1](#) when a legal person is a party in proceedings before the Office, they can also be represented by an employee, even if that employee does not work directly for the legal person identified by the legal address. This is particularly relevant for legal persons with a legal address outside the EEA since representation is mandatory for them (see [paragraph 5.1](#) below). These non-EEA legal persons may be represented by an employee in the following two scenarios:

- first, legal persons with a legal address outside the EEA , but having a real and effective industrial or commercial establishment within the EEA , may be represented before the Office by an employee of this EEA-based establishment;
- second, legal persons with a legal address outside the EEA may be represented by an employee of another legal person within the EEA provided that both legal persons are economically connected.

For the definition of legal address as identified in the represented persons ID number, see [paragraph 3.2.1](#) .

In the **first scenario** , to successfully claim an employee representative, the represented legal person must show that even though their legal address is outside the EEA, they also have a real and effective industrial or commercial establishment in the EEA, e.g. by proving that they own or control a branch, agency or any other kind of commercial establishment (including subsidiaries) in the EEA to such extent that it can be considered an extension of the non-EEA legal person.

The concept of 'branch, agency or other establishment' implies a place of business which has the appearance of permanency, such as the extension of a parent body, has a management and is materially equipped to negotiate business with third parties so that the latter, although knowing that there will if necessary be a legal link with the parent body, the office of which is abroad, do not have to deal directly with that parent body but may transact business at the place of business constituting the extension (see definition in 22/11/1978, [C-33/78](#), Somafer, EU:C:1978:205, § 12; also quoted in 22/09/2016, [T-512/15](#) , Sun Cali (Fig.), EU:T:2016:527, § 30).



Proof of employment at the EEA-based establishment must also be provided for the employee representative.

For example, the EUTM applicant is a company with a legal address in the US. However, it can **prove** that it owns a branch in Spain. The party must **claim and prove** that the natural person identified as the employee representative works for the establishment in Spain. An employee working for this Spanish establishment can then represent the US EUTM applicant before the Office.

In the **second scenario**, to successfully claim an employee representative, the legal assessment is similar. Firstly, the legal person must show that the other legal person exists within the EEA; secondly, that there is a sufficiently strong economic connection between the represented party and the EEA-based legal person; and thirdly, that the employee representative truly works for the EEA-based legal person.

For example, 'Company A LLC' with a legal address in the US is party to the proceedings before the Office. It can show that it is economically linked to 'Company B Ltd.' in Ireland. John Smith is employed by 'Company B Ltd.' in Ireland. Consequently, John Smith may act as an employee representative of the US-based 'Company A LLC'.

Similar to the first scenario, economic connections only exist when there is economic dependence between the two legal persons, either in the sense that the party to the proceedings is dependent on the employer of the employee concerned, or vice versa. This economic dependence may exist for example:

- either because the two legal persons are members of the same group; or
- because of management control mechanisms (22/09/2016, [T-512/15](#), SUN CALI (fig.), EU:T:2016:527, § 33 et seq.).

However, the following do not establish economic links:

- a connection by virtue of a trade mark licensing agreement;
- a contractual relationship between two enterprises aimed at mutual representation or legal assistance;
- a mere supplier/client relationship, for example, on the basis of an exclusive distribution or franchising agreement.

All the arguments and evidence the requester deems necessary to support the claims, including any evidence to prove the existence and nature of the link between the different entities and any proof of employment, must be submitted together with the request. If this evidence is not submitted, the Office will issue a deficiency.

## 4.5 Legal representation and signature

Legal representation refers to the representation of natural or legal persons through other persons in accordance with national law. For example, the president of a company is the legal representative of that company.

In all cases, a natural person that is acting as a legal representative, should indicate underneath the signature(s), the name(s) of the individual person(s) signing and the person's(persons') status, for example, 'president', 'chief executive officer', 'gérant', 'procuriste', 'Geschäftsführer' or 'Prokurist'.

Other examples of legal representation according to national law are cases where minors are represented by their parents or by a custodian, or a company is represented by a liquidator. In these cases, the person actually signing must demonstrate his or her capacity to sign even though no authorisation is required.

It should be borne in mind, however, that a legal person addressing the Office from outside the EEA must be represented by a professional representative within the EEA, unless appointment of a representative is not mandatory (see [paragraph 5.1](#) for any exceptions to the general rule). See [paragraph 5.2.1](#) on the consequences of not appointing a representative, when representation is mandatory, once the EUTM or RCD application has been filed.

## **5 Appointment of a Professional Representative**

### **5.1 Conditions under which appointment is mandatory**

Subject to the exceptions outlined in [paragraph 4.4](#) above, the appointment of a professional representative is mandatory for parties to proceedings before the Office that do not have their domicile or their principal place of business, or a real and effective industrial or commercial establishment **in the EEA**. This obligation exists for all proceedings before the Office, except for the filing of an application for an EUTM or an RCD, an application for renewal of an EUTM or an RCD, and an application for inspection of files.

The same applies to international registrations designating the EU. For further information on this point, please see [the Guidelines, Part M, International Marks](#).

#### **5.1.1 Domicile, principal place of business, or real and effective industrial or commercial establishment**

The criterion for mandatory representation is determined by the legal address of the represented person, not their nationality. For example, a French national domiciled in Japan has to be represented, but an Australian national domiciled in Belgium does not have to be. For more information on the legal address, see [paragraph 3.2.1](#).

The criterion is not fulfilled where the party to the proceedings merely has a post office box or an address for service in the EEA, nor where the applicant indicates the address of an agent with a place of business in the EEA. For more information on situations where a party may have a legal address outside the EEA but may also have a real and effective industrial or commercial establishment within the EEA, please see

[paragraph 4.4.1](#), which deals with this concept for the purpose of determining if an employee representative is entitled to represent.

### 5.1.2 The notion of 'in the EEA'

[Article 119\(2\) EUTMR](#)

In applying [Article 119\(2\) EUTMR](#), the relevant territory is the territory of the EEA, which comprises the EU and the countries of Iceland, Liechtenstein and Norway.

Article 77(2) CDR

For RCDs, according to Articles 77 and 78 CDR, the relevant territory for establishing the obligation to be represented and the place where the representative must be based in the sense of Article 78 CDR is the EU. However, following the judgment in the *Paul Rosenich* case (13/07/2017, [T-527/14](#), PAUL ROSENICH, EU:T:2017:487), the Office deems the EEA to be the relevant territory, with the result that the considerations previously applied to the EEA in trade mark matters now also apply to designs.

## 5.2 Consequences of non-compliance when appointment is mandatory

[Article 120\(1\) EUTMR](#)

Article 78(1) CDR

Where a party to proceedings before the Office is in one of the situations described under [paragraph 5.1](#), but has failed to appoint a professional representative within the meaning of [Article 120\(1\) EUTMR](#) or Article 78(1) CDR in the application or request, or where compliance with the representation requirement ceases to exist at a later stage (e.g. where the representative withdraws), the legal consequences depend on the nature of the proceedings concerned.

### 5.2.1 During registration

Articles [31\(3\)](#) and [119\(2\)](#) EUTMR

Article 10(3)(a) CDIR

Where representation is mandatory and the applicant fails to designate a professional representative in the application form, the examiner will invite the applicant to appoint a representative as part of the formality examination pursuant to [Article 31\(3\) EUTMR](#), first sentence, or Article 10(3)(a) CDIR. Where the applicant fails to remedy this deficiency, the application will be refused.

The same course of action will be taken where the appointment of a representative ceases to exist later during the registration process, up until any time before actual registration, that is to say, even within the period between publication of the EUTM application and registration of the EUTM.

Where a specific ('secondary') request is introduced on behalf of the applicant during the registration process, for example a request for inspection of files, a request for registration of a licence or a request for *restitutio in integrum*, the appointment of a representative need not be repeated, but the Office may in case of doubt request an authorisation. The Office will in this case communicate with the representative on file, and the representative for the recordal applicant, where different.

### 5.2.2 During opposition

For EUTM applicants, the preceding paragraphs apply where appointment of a representative is mandatory. The procedure to remedy any deficiencies relating to representation will take place outside the opposition proceedings. Where the applicant fails to remedy the deficiency, the EUTM application will be refused, and the opposition proceedings will be terminated.

[Article 2\(2\)\(h\)\(ii\)](#) and [Article 5\(5\) EUTMDR](#)

As regards the opponent, any initial deficiency relating to representation is a ground for inadmissibility of the opposition. Where representation is mandatory pursuant to [Article 119\(2\) EUTMR](#) and the notice of opposition does not contain the appointment of a representative, the examiner will invite the opponent to appoint a representative within a 2-month time limit pursuant to [Article 5\(5\) EUTMDR](#). If the deficiency is not remedied before the time limit expires, the opposition will be rejected as inadmissible.

When a representative resigns, the proceedings continue with the opponent itself if it is from the EEA. If the opponent is from outside the EEA, the Office will issue a deficiency inviting the opponent to appoint a representative. If the deficiency is not remedied, the opposition will be rejected as inadmissible.

When there is a withdrawal, change or appointment of a representative during opposition proceedings, the Office will inform the other party of the change by sending a copy of the letter and of the authorisation (if submitted).

### 5.2.3 Cancellation

[Article 12\(1\)\(c\)\(ii\)](#) and [Article 15\(4\) EUTMDR](#)

In cancellation proceedings, the above paragraphs concerning the opponent apply *mutatis mutandis* to the applicant for revocation or declaration of invalidity of an EUTM.

Where an EUTM proprietor from outside the EEA is no longer represented, the examiner will invite it to appoint a representative. If it does not do so, procedural statements made by it will not be taken into account, and the cancellation application

will be dealt with on the basis of the evidence that the Office has before it. However, a registered EUTM will not be cancelled simply because an EUTM proprietor from outside the EEA is no longer represented.

### **5.3 Appointment of a representative when not mandatory**

Where the party to the proceedings before the Office is not obliged to be represented, they may nevertheless, at any time, appoint a representative within the meaning of Article [119](#) or [120](#) EUTMR and Articles 77 and 78 CDR.

Where a representative has been appointed, the Office will communicate solely with that representative (see [paragraph 6](#) below).

### **5.4 Appointment/replacement of a representative**

#### **5.4.1 Explicit appointment/replacement**

[Article 74\(7\) EUTMDR](#)

Article 1(1)(e) and Article 62(8) CDIR

A representative is normally appointed in the official Office form initiating the procedure involved, for example, the application form or the opposition form (as concerns the appointment of multiple representatives, see [paragraph 6](#) below).

A representative may also be appointed in a subsequent communication. In the same way, a representative may also be replaced at any stage of the proceedings.

The appointment must be unequivocal.

It is strongly recommended that the request for registration of an appointment of a representative be submitted electronically via the Office's website (e-recordals).

An application to record an appointment must contain:

- the registration or application number of the EUTM/RCD registration or application;
- the new representative's particulars;
- the signature(s) of the person(s) requesting the recordal.

When the application does not comply with the above, the recordal applicant will be invited to remedy the deficiency. The notification will be addressed to the person who filed the application to record the appointment of the representative. If the recordal applicant fails to remedy the deficiency, the Office will reject the application.

Where a representative has been appointed, the notification will be sent to the party that submitted the application to register the appointment, that is to say, to the recordal applicant. Any other party, including the previous representative in the case of a replacement when he or she is not the recordal applicant, will be informed of the

appointment in a separate communication only once the appointment has been registered.

When the application relates to more than one proceeding, the recordal applicant must select a language for the application that is common to all proceedings. If there is no common language, separate applications for appointment must be filed. For more information on the use of languages see [the Guidelines, Part A, General Rules, Section 4, Language of Proceedings](#).

If there is no representative in the proceedings, a communication made in respect of a particular procedure (e.g. registration or opposition), accompanied by an authorisation signed by the party to the proceedings, implies the appointment of a representative. This also applies where a general authorisation is filed in the same way. For information about general authorisations, see [paragraph 7.2](#) below.

If there is already a representative in the proceedings, the person represented has to clarify whether the former representative will be replaced.

#### 5.4.2 Implicit appointment

Submissions, requests, etc. filed on behalf of the parties by a representative (hereafter the 'new' representative) other than the one who appears in our register (hereafter the 'old' representative) will initially be accepted.

The Office will then send a letter to the 'new' representative inviting him or her to confirm his or her appointment within 1 month. The letter will include a warning that if the representative does not reply within the time limit, the Office will assume that he or she has not been appointed as representative.

If the 'new' representative confirms his or her appointment, the submission will be taken into account and the Office will send further communications to the 'new' representative.

If the 'new' representative does not reply within 1 month or confirms that he or she is not the 'new' representative, the proceedings will go on with the 'old' representative. The submission and the answer from the 'new' representative will not be taken into account and will be forwarded to the 'old' representative for information purposes only.

In particular, when the submission leads to the closure of proceedings (withdrawals/limitations), the 'new' representative must confirm his or her appointment as representative so that the closure of proceedings or the limitation can be accepted. In any case, the proceedings will not be suspended.

### 5.4.3 Associations of representatives

[Article 74\(8\) EUTMDR](#)

Article 62(5) CDR

An association of representatives (such as firms or partnerships of lawyers or professional representatives or both) may be appointed rather than the individual representatives working within that association.

In order for the Office to grant an ID number to an association of representatives (see [paragraph 4.1](#) above), there must be at least two legal practitioners or professional representatives practising within that association or partnership that comply with the requirements of [Article 120\(1\) EUTMR](#) or Article 78(1) CDR and that have already obtained individual ID numbers from the Office assigned to the address of the association. This information should be submitted with the initial request.

Where the Office had doubts that the association has at least a minimum of two members complying with the requirements, or doubts regarding the continued presence of at least two qualified association members, the Office will issue a deficiency notification. This deficiency may be issued at the time of examining the initial request, or at any later stage. In the event the deficiency is not remedied, any existing association ID number will be invalidated, and any files assigned to this existing ID will be moved to the individual ID of the only existing member of the association.

The appointment of an association of representatives automatically extends to any professional representative who, subsequent to the initial appointment, joins that association of representatives. Conversely, any representative who leaves the association of representatives automatically ceases to be authorised under that association. It is strongly recommended that any changes and information concerning representatives joining or leaving the association be notified to the Office. The Office reserves the right, if justified under the circumstances of the case, to verify whether a given representative actually works within the association.

[Article 120\(1\) EUTMR](#)

[Article 74 EUTMDR](#)

Article 78(1) CDR

Article 62 CDR

The appointment of an association of representatives does not depart from the general rule that only legal practitioners and professional representatives within the meaning of [Article 120\(1\) EUTMR](#) and Article 78(1) CDR may perform legal acts before the Office on behalf of third parties. Thus, any application, request or communication must be signed by a physical person possessing this qualification. The representative must indicate his or her name underneath the signature. He or she may indicate his or her

individual ID number, if one has been provided by the Office, or his or her association ID number.

## 6 Communication with Parties and Representatives

[Article 60\(1\) and \(3\)](#) and [Article 66 EUTMDR](#)

Article 53(1) and (3) and Article 63 CDIR

Where a representative has been appointed within the meaning of Article [119](#) or [120](#) EUTMR and Article 77 or 78 CDR, the Office will communicate solely with that representative.

Any notification or other communication addressed by the Office to the duly authorised representative will have the same effect as if it had been addressed to the person represented.

Any communication addressed to the Office by the duly authorised representative will have the same effect as if it originated from the person represented.

In addition, if the party represented files documents itself with the Office while being represented by a duly authorised representative, these documents will be accepted by the Office as long as the party represented has its domicile or principal place of business or a real and effective industrial or commercial establishment in the EEA. However, the Office will reply to the appointed representative, not to the party directly. Where the represented party has its domicile or principal place of business or a real and effective industrial or commercial establishment outside the EEA, these documents will not be taken into account.

[Article 60\(2\)](#) and [Article 73 EUTMDR](#)

Article 53(2) and Article 61 CDIR

A party to the proceedings before the Office may appoint up to a maximum of two representatives, in which case each of the representatives may act either jointly or separately, unless the authorisation given to the Office provides otherwise. The Office, however, will as a matter of course communicate only with the first named representative, except where the additional representative is appointed for a specific secondary procedure (such as inspection of files or opposition), in which case the Office will communicate with this representative during the course of this specific secondary procedure.



[Article 119\(4\) EUTMR](#)

Articles [60\(1\) and \(2\)](#) and [73\(1\)](#) EUTMDR

Article 61(1) CDIR

Where there is more than one applicant, opponent or any other party to proceedings before the Office, a common representative may be expressly appointed.

Where a common representative is not expressly appointed, the first applicant named in the application that is domiciled in the EEA, or its representative if appointed, will be considered to be the common representative.

If none of the applicants are domiciled in the EEA, they are obliged to appoint a professional representative; therefore, the first named professional representative appointed by any of the applicants will be considered to be the common representative.

The Office will address all notifications to the common representative.

## 7 Authorisation

Articles [119\(3\)](#) and [120\(1\)](#) EUTMR

[Article 74 EUTMDR](#)

Articles 77(3) and 78(1) CDR

Article 62 CDIR

In principle, professional representatives do not need to file an authorisation to act before the Office. However, any professional representative (legal practitioner or Office professional representative entered on the list, including an association of representatives) acting before the Office must file an authorisation for insertion in the files if the Office expressly requires this or, where there are several parties to the proceedings in which the representative acts before the Office, if the other party expressly asks for this.

In such cases, the Office will invite the representative to file the authorisation within a specific time limit. The letter will include a warning that if the representative does not reply within the time limit, the Office will assume that he or she has not been appointed as representative and proceedings will continue directly with the party. Where representation is mandatory, the party represented will be invited to appoint a new representative and [paragraph 5.2](#) above applies. Any procedural steps, other than the filing of the application, taken by the representative will be deemed not to have been taken if the party represented does not approve them within a period specified by the Office.

An authorisation must be signed by the party to the proceedings. In the case of legal persons, it must be signed by a person who is entitled, under the applicable national law, to act on behalf of that person.

Simple photocopies of the signed original may be submitted. Original documents become part of the file and, therefore, cannot be returned to the person who submitted them.

Authorisations may be submitted in the form of individual or general authorisations.

## 7.1 Individual authorisations

[Article 120\(3\) EUTMR](#)

[Article 65\(1\)\(i\)](#) and [Article 74 EUTMDR](#)

Article 78(5) CDR

Article 62 and Article 68(1)(i) CDIR

Individual authorisations may be made on the form established by the Office pursuant to [Article 65\(1\)\(i\) EUTMDR](#) and Article 68(1)(i) CDIR. The procedure to which the authorisation relates must be indicated (e.g. 'concerning EUTM application number 12345'). The authorisation will then extend to all acts during the lifetime of the ensuing EUTM. Several proceedings may be indicated.

Individual authorisations, whether submitted on the form made available by the Office or on the representative's own form, may contain restrictions as to its scope.

## 7.2 General authorisations

[Article 120\(1\) EUTMR](#)

[Article 65\(1\)\(i\)](#) and [Article 74 EUTMDR](#)

Article 78(1) CDR

Article 62 and Article 68(1)(i) CDIR

A 'general authorisation' authorises the representative, the association of representatives or the employee to perform all acts in all proceedings before the Office, including, but not limited to, the filing and prosecution of EUTM applications, the filing of oppositions and the filing of requests for a declaration of revocation or invalidity, as well as in all proceedings concerning RCDs and international marks. The authorisation should be made on the form made available by the Office, or a form with the same content. The authorisation must cover all proceedings before the Office and may not contain limitations. For example, where the text of the authorisation relates to the 'filing

and prosecution of EUTM applications and defending them', this is not acceptable because it does not cover the authority to file oppositions and requests for a declaration of revocation or invalidity. Where the authorisation contains such restrictions, it will be treated as an individual authorisation.

### **7.3 Consequences where authorisation expressly requested by the Office is missing**

If representation is not mandatory, the proceedings will continue with the person represented.

If representation is mandatory, [paragraph 5.2](#) above will apply.

## **8 Withdrawal of a Representative's Appointment or Authorisation**

A withdrawal or change of representative may be brought about by an action taken by the person represented, the previous representative or the new representative.

### **8.1 Action taken by the person represented**

[Article 74\(4\) EUTMDR](#)

Article 62(5) CDIR

The person represented may at any time revoke, in a written and signed communication to the Office, the appointment of a representative or the authorisation granted to them. Revocation of an authorisation implies revocation of the representative's appointment.

[Article 74\(5\) EUTMDR](#)

Article 62(6) CDIR

Any representative who has ceased to be authorised will continue to be regarded as the representative until the termination of that representative's authorisation has been communicated to the Office.

Where the party to the proceedings is obliged to be represented, [paragraph 5.2](#) above will apply.

## 8.2 Withdrawal by the representative

The representative may at any time declare, by a signed communication to the Office, that they withdraw as a representative. The request must indicate the number of the proceedings (e.g. EUTM/RCD number, opposition, etc.). If the representative declares that representation will be taken over by another representative as from that moment, the Office will record the change accordingly and correspond with the new representative.

## 9 Death or Legal Incapacity of the Party Represented or Representative

### 9.1 Death or legal incapacity of the party represented

[Article 74\(6\) EUTMDR](#)

Article 62(7) CDIR

In the event of the death or legal incapacity of the authorising party, the proceedings will continue with the representative, unless the authorisation contains provisions to the contrary.

[Article 106\(1\) EUTMR](#)

Article 59(1) CDIR

Depending on the proceedings, the representative will have to apply for registration of a transfer to the successor in title. However, in the event of the death or legal incapacity of the applicant for, or proprietor of, an EUTM, the representative may apply for an interruption of proceedings. For more information on interrupting opposition proceedings following the death or legal incapacity of the EUTM applicant or its representative, see the Guidelines, [Part C, Opposition, Section 1, Procedural Matters](#).

In insolvency proceedings, a liquidator, once nominated, will assume the capacity to act on behalf of the bankrupt person and may — or (in the case of mandatory representation) must — appoint a new representative, or else confirm the appointment of the existing representative.

For more information on insolvency proceedings, see the Guidelines, [Part E, Register Operations, Section 3, EUTMs and RCDs as Objects of Property, Chapter 2, Licences, Rights \*in Rem\*, Levies of Execution, Insolvency Proceedings, Entitlement Proceedings or Similar Proceedings](#).

## 9.2 Death or legal incapacity of the representative

[Article 106\(1\) and \(2\) EUTMR](#)

[Article 72\(2\) EUTMDR](#)

Article 59(1)(c) and Article 59(3) CDIR

In the event of the death or legal incapacity of a representative, the proceedings before the Office will be interrupted. If the Office has not been informed of the appointment of a new representative within a period of 3 months after the interruption, the Office will:

- where representation is not mandatory, inform the authorising party that the proceedings will now be resumed with them;
- where representation is mandatory, inform the authorising party that the legal consequences will apply, depending on the nature of the proceedings concerned (e.g. the application will be deemed to have been withdrawn, or the opposition will be rejected), if a new representative is not appointed within 2 months of the date of notification of that communication (28/09/2007, [R 48/2004-4](#), PORTICO / PORTICO, § 13, 15).

## 10 Change of name and address

[Article 55](#) and [Article 111\(3\)\(a\) and \(b\) EUTMR](#)

Article 19 CDIR, Article 69(3)(a) and (b) CDIR

The name and legal address of an EUTM or an RCD applicant, a party to the proceedings, or a representative may be amended.

A change of name is limited to a change that does not affect the identity of the person, for example, where there is a change in the name (through marriage/divorce), or in the case of a legal person, where the company officially changes its name in the company register.

On the other hand, a change in the party's identity may be a transfer or a change of ownership. In the event of any doubt as to whether a change will be considered a transfer or a change of ownership, see the Guidelines, [Part E, Register Operations, Section 3, EUTMs and RCDs as Objects of Property, Chapter 1, Transfer](#). That chapter provides detailed information in this respect as well as the applicable procedure.

A representative's name and address may be amended, provided that the representative is not being substituted by another representative. That would be considered an appointment of a new representative, which is subject to the rules governing such an appointment.

Where the address of an association of representatives is changed, the address of all of the association members must also be updated. As seen in [paragraph 5.4.3](#), the

address linked to the ID numbers of the members of an association and the address linked to the ID number of the association itself must all coincide.

A change of name or address can be requested by the affected person. The request must contain the EUTM/RCD number (or the file number assigned to the proceedings in question) and the name and address of the party or representative, both as on the file and as amended. The ID number should also be provided. The request is free of charge.

Where there is any doubt, the Office may ask for proof such as an extract from a trade register, or other evidence, to corroborate the change of name or address.

Changes to the parties' or representatives' name or address will be reflected in the ID number assigned to the party or representative. Consequently, the change will be reflected in all proceedings where this ID is assigned, including all EUTM and RCD applications and pending proceedings. The change cannot be recorded only for a specific portfolio of rights.

For changes in the name or address of the proprietor of a registered EUTM or RCD, see the Guidelines, [Part E, Register Operations, Section 1, Changes in a registration](#).

## 11 Correction of the name or address

[Article 31\(1\)\(b\) EUTMR](#), [Article 49\(2\) EUTMR](#)

[Article 11 EUTMDR](#)

Article 36(1)(b) CDR

Article 12(2) CDIR

The name and legal address of an EUTM or an RCD applicant, a party to the proceedings, or a representative may be corrected in case of errors in the respective application or request.

Firstly, corrections pursuant to [Article 49\(2\) EUTMR](#) and Article 12(2) CDIR will be allowed where the error in the name or address that requires correction is considered **obvious**, that is, nothing else could have been intended other than what is offered as the correction. Examples of obvious errors in the name or address could be misspellings, typographical errors, errors of transcription or use of an abbreviated form in the names of natural persons (e.g. 'Phil' instead of 'Phillip').

Additionally, a correction could also be considered in this scenario where there is a typographical error in the legal form (e.g. S.A. was indicated in the application form instead of S.L.). This correction would require evidence to be submitted in support of the request.

Where a correction takes place in the name or address of an EUTM or RCD applicant pursuant to [Article 49\(2\) EUTMR](#) and Article 12(2) CDIR, this correction will have no consequences as regards the filing date of the application, because the applicant is deemed to be correctly identified from the beginning pursuant to [Article 31\(1\)\(b\) EUTMR](#) and Article 36(1)(b) CDR.

Secondly, errors that are **not considered to be obvious** and that lead to the **change in identification of the EUTM or RCD applicant** can take place, but they do not fall under [Article 49\(2\) EUTMR](#) and Article 12(2) CDR. They will lead to a change in the filing date of the application, as the correct identification of the applicant is a formal requirement for the granting of a filing date pursuant to [Article 31\(1\)\(b\) EUTMR](#) and Article 36(1)(b) CDR. The new filing date of the application will be considered to be the one on which the corrected (new) applicant is formally identified and all supporting evidence is submitted in support of the correction.

In this second scenario, the burden of proof is on the party that made the mistake to prove what needs correcting and why it needs correcting. A request for correction of a name which consists of replacing one name with another will require evidence of what needs correcting and the evidence will also need to link the correction to the EUTM/RCD application (or file) in question. For example, where a representative informs the Office that the wrong EUTM applicant was indicated in the EUTM application form by mistake, the evidence must show that the party (as requested to be corrected) bears a relation with the EUTM application in question. A request simply informing the Office that the correction is needed because someone made a mistake, or another applicant was intended, or there was a change of mind after filing, will not be accepted.

Requests for correction of errors must contain the file number of the application or proceeding, the erroneous name or address and its corrected version, and evidence in support of the request for correction where applicable.

Corrections should not be confused with requests for changes of name or address, see [paragraph 10](#).

## Annex 1

National/ Regional IP Office (Country)	Type of representative	National terminology	Entitlements/specific rules for representing clients in trade mark and design matters
OPA – The Austrian Patent Office (Austria)	Legal practitioner  <a href="#">Article 120(1)(a) EUTMR</a> / Article 78(1)(a) CDR	‘Rechtsanwalt’	Persons holding the title ‘Rechtsanwalt’ , meaning a lawyer admitted to the bar, are entitled to act as legal practitioners before the national industrial property office pursuant to Austrian law, and consequently entitled to act before the EUIPO in trade mark and design matters.
	Professional Representative (Trade Marks and Designs)  <a href="#">Article 120(2)(c) EUTMR</a> / Article 78(1)(b) CDR)	‘Zugelassener Vertreter’  ‘Patentanwalt’ or ‘Notar’	<b>Entitlement is conditional upon possession of a special professional qualification</b>  Persons holding the titles ‘Patentanwalt’ or ‘Notar’ have the necessary ‘special professional qualification’ and are therefore entitled to act as professional representatives before the EUIPO.



National/ Regional IP Office (Country)	Type of representative	National terminology	Entitlements/specific rules for representing clients in trade mark and design matters
BOIP – Benelux Office for Intellectual Property (Benelux)	<p><b>Legal practitioner</b></p> <p><a href="#">Article 120(1)(a) EUTMR</a> / Article 78(1)(a) CDR</p>	<p>‘Advocaat’, ‘Rechtsanwalt’ or ‘Avocat’</p>	<p>Persons holding the titles ‘Avocat’ , ‘Advocaat’ or ‘Rechtsanwalt’ (meaning a lawyer admitted to the bar), are entitled to act as legal practitioners before the Benelux industrial property office pursuant to national laws, and consequently entitled to act before the EUIPO in trade mark and design matters.</p>
	<p><b>Professional Representative (Trade Marks and Designs)</b></p> <p><a href="#">Article 120(2)(c) EUTMR</a> / Article 78(1)(b) CDR)</p>	<p>‘Gemachtigde’ , ‘Patentanwalt’ or ‘mandataire’</p>	<p><b>Representation is open to anybody</b></p> <p><b>a. who has acted before the national office for at least 5 years, or</b></p> <p><b>b. who is exempt from the 5-year requirement as they are in possession of a professional qualification officially recognised in accordance with the regulations laid down by that State</b></p> <hr/> <p>Any person may act before the Benelux Office for Intellectual Property. In order for this person to be entitled to act as a professional representative before the EUIPO, the person must have at least 5 years’ experience before the Benelux Intellectual Property Office (<b>Option a</b>).</p> <p>Persons in possession of a professional qualification officially recognised under the regulations laid down by the States of Belgium, the Netherlands or Luxembourg, certified by the central industrial property office of the Member State concerned, are not subject to the 5-year requirement before the BOIP to act as a professional representative before the EUIPO (<b>Option b</b>) .</p>

National/ Regional IP Office Office (Country)	Type of representative	National terminology	Entitlements/specific rules for representing clients in trade mark and design matters
BPO – Patent Office of the Republic of Bulgaria (Bulgaria)	Legal practitioner  <a href="#">Article 120(1)(a) EUTMR</a> / Article 78(1)(a) CDR	<b>Адвокат</b> (‘Advokat’)	Persons holding the title ‘ <b>Адвокат</b> ’ (Attorney) are entitled to act as legal practitioners before the national industrial property office pursuant to the laws of Bulgaria, and consequently they are entitled to act before the EUIPO in trade mark and design matters.
	Professional Representative (Trade Marks and Designs)  <a href="#">Article 120(2)(c) EUTMR</a> / Article 78(1)(b) CDR	<b>Представител по индустриална собственост</b> (‘Predstavitel po industrialna sobstvenost’)	<b>Entitlement is conditional upon possession of a special professional qualification</b>  Persons holding the title ‘ <b>Представител по индустриална собственост</b> ’ (‘IP representative’) have the necessary ‘special professional qualification’ and are therefore entitled to act as professional representatives before the EUIPO.
SIPO – State Intellectual Property Office of the Republic of Croatia (Croatia)	Legal practitioner  <a href="#">Article 120(1)(a) EUTMR</a> / Article 78(1)(a) CDR	‘odvjetnik’	Persons holding the title ‘ <b>odvjetnik</b> ’, meaning a lawyer admitted to the bar, are entitled to act as legal practitioners before the national industrial property office pursuant to Croatian law, and consequently entitled to act before the EUIPO in trade mark and design matters.
	Professional Representative (Trade Marks and Designs)  <a href="#">Article 120(2)(c) EUTMR</a> / Article 78(1)(b) CDR	‘Ovlašteni zastupnici’  ‘Zastupnik Za Žigove’	<b>Entitlement is conditional upon possession of a special professional qualification</b>  Persons holding the title ‘ <b>Zastupnik Za Žigove</b> ’ have the necessary ‘special professional qualification’ and are therefore entitled to act as professional representatives before the EUIPO. An exam must be passed, before the Croatian Intellectual Property Office, in order to obtain this qualification.

National/ Regional IP Office Office (Country)	Type of representative	National terminology	Entitlements/specific rules for representing clients in trade mark and design matters
Industrial Property Office of the Czech Republic (Czech Republic)	Legal practitioner  <a href="#">Article 120(1)(a) EUTMR</a> / Article 78(1)(a) CDR	‘Advokát’	Persons holding the title ‘Advokát’ , meaning a lawyer admitted to the bar, are entitled to act as legal practitioners before the national industrial property office pursuant to the laws of the Czech Republic, and consequently entitled to act before the EUIPO in trade mark and design matters.
	Professional Representative (Trade Marks and Designs)  <a href="#">Article 120(2)(c) EUTMR</a> / Article 78(1)(b) CDR	‘Kvalifikovaný ch zástupců’  ‘Patentový zástupce’	<p><b>Entitlement is conditional upon possession of a special professional qualification</b></p> <p>Persons holding the title ‘Patentový zástupce’ have the necessary ‘special professional qualification’ and are therefore entitled to act as professional representatives before the EUIPO. The Czech Republic has a two-part examination:</p> <ul style="list-style-type: none"> <li>• Persons who have passed <u>part B only</u> (on ‘trade marks and appellation of origin’) may act as representatives in this field and hence be entered on the list of <a href="#">Article 120(1)(b) EUTMR</a> to represent <u>in trade mark matters</u> .</li> </ul> <p>Patent attorneys (<i>‘Patentový zástupce’</i> ) , who have passed <u>both parts</u> of the examination, are therefore entitled to represent applicants in all procedures before the EUIPO (i.e. <u>both trade mark and design matters</u> ).</p>

National/ Regional IP Office (Country)	Type of representative	National terminology	Entitlements/specific rules for representing clients in trade mark and design matters
Department of the Registrar of Companies and Official Receiver (Cyprus)	Legal practitioner <a href="#">Article 120(1)(a)</a> EUTMR / Article 78(1)(a) CDR	‘δικηγόρο’ (‘Dikigoros’)	Only persons holding the title ‘Δικηγόρος’ (or ‘Dikigoros’), are entitled to act as legal practitioners before the national industrial property office pursuant to the laws of Cyprus, and consequently entitled to act before the EUIPO in trade mark and design matters.
	Professional Representative (Trade Marks and Designs) <a href="#">Article 120(2)(c)</a> EUTMR / Article 78(1)(b) CDR)	‘εγκεκριμένων αντιπροσώπων’	n/a

National/ Regional IP Office (Country)	Type of representative	National terminology	Entitlements/specific rules for representing clients in trade mark and design matters
DKPTO – Danish Patent and Trademark Office (Denmark)	Legal practitioner <a href="#">Article 120(1)(a) EUTMR</a> / Article 78(1)(a) CDR	‘advokat’	Persons holding the Danish title ‘Advokat’ meaning a lawyer admitted to the bar, are entitled to act as legal practitioners before the national industrial property office pursuant to Danish law, and consequently entitled to act before the EUIPO in trade mark and design matters.
	Professional Representative (Trade Marks and Designs) <a href="#">Article 120(2)(c) EUTMR</a> / Article 78(1)(b) CDR)	‘Godkendte mødeberettigede’  ‘Varemaerkefuldmaegtig’	<p><b>Representation is open to anybody</b></p> <p><b>a. who has acted before the national office for at least 5 years, or</b></p> <p><b>b. who is exempt from the 5-year requirement as they are in possession of a professional qualification officially recognised in accordance with the regulations laid down by that State</b></p> <p>Anyone may act before the national industrial property office <u>in trade mark matters</u> . In order for this person to be entitled to act as a professional representative before the EUIPO, the person must have at least 5 years’ experience before the national office (<b>Option a</b>) .</p> <p>In addition, persons holding the title ‘<b>Varemaerkefuldmaegtig</b>’ are officially recognised as professionally qualified to represent third parties before the national office <u>in trade mark and design matters</u> and are therefore not subject to the 5-year requirement to act as a professional representative before the EUIPO (<b>Option b</b>).</p>

National/ Regional IP Office (Country)	Type of representative	National terminology	Entitlements/specific rules for representing clients in trade mark and design matters
EPA – Estonian Patent Office (Estonia)	<b>Legal practitioner</b>  <a href="#">Article 120(1)(a) EUTMR</a> / Article 78(1)(a) CDR	<b>‘õigusala töötaja’</b>  <b>‘Jurist’</b> and <b>‘Advokaat’</b>	Persons holding the titles <b>‘Jurist’</b> and <b>‘Advokaat’</b> who are also qualified as IP attorneys are entitled to act as legal practitioners before the national industrial property office pursuant to Estonian law, and consequently entitled to act before the EUIPO in trade mark and design matters.
	<b>Professional Representative (Trade Marks and Designs)</b>  <a href="#">Article 120(2)(c) EUTMR</a> / Article 78(1)(b) CDR)	<b>‘Kutseline esindaja’</b>  <b>‘Patendivolnik’</b>	<b>Entitlement is conditional upon possession of a special professional qualification</b>  Persons holding the title <b>‘Patendivolnik’</b> who have passed the <u>‘trade marks, industrial designs and geographical indications’</u> part of the exam, have the necessary ‘special professional qualification’ and are therefore entitled to act as professional representatives before the EUIPO in trade mark and design matters. Persons who only passed the ‘patents and utility models’ part of the exam may not act as professional representatives before the EUIPO.

National/ Regional IP Office (Country)	Type of representative	National terminology	Entitlements/specific rules for representing clients in trade mark and design matters
PRH – Finnish Patent and Registration Office (Finland)	<b>Legal practitioner</b>  <a href="#">Article 120(1)(a) EUTMR</a> / Article 78(1)(a) CDR	<b>‘harjoittamaan oikeutettu’</b>  <b>‘Asianajaja’</b> or <b>‘Advokat’</b>	Persons holding the Finnish title <b>‘Asianajaja’</b> or <b>‘Advokat’</b> , meaning a lawyer admitted to the bar, are entitled to act as legal practitioners before the national industrial property office pursuant to the laws of Finland, and consequently entitled to act before the EUIPO in trade mark and design matters.
	<b>Professional Representative (Trade Marks and Designs)</b>  <a href="#">Article 120(2)(c) EUTMR</a> / Article 78(1)(b) CDR)	<b>‘Ammattimain en edustaja’</b>  <b>‘Tavaramerkki asiamies’</b>	<p><b>Representation is open to anybody</b></p> <p><b>a. who has acted before the national office for at least 5 years, or</b></p> <p><b>b. who is exempt from the 5-year requirement as they are in possession of a professional qualification officially recognised in accordance with the regulations laid down by that State</b></p> <hr/> <p>Any natural or legal person can act as a representative <u>in trade mark and design matters</u> before the national industrial property office. In order for this person to be entitled to act as a representative before the EUIPO, the person must have at least 5 years’ experience before the national industrial property office <b>(Option a)</b>.</p> <p>In addition, persons holding the title <b>‘Tavaramerkkiasiamies’</b> are officially recognised as being professionally qualified to represent third parties before the Finnish Patent and Registration Office <u>in trade mark matters</u>, and therefore are not subject to the 5-year requirement to act as professional representative before the EUIPO <b>(Option b)</b>.</p>

National/ Regional IP Office (Country)	Type of representative	National terminology	Entitlements/specific rules for representing clients in trade mark and design matters
INPI – The National Institute for Intellectual Property (France)	<b>Legal practitioner</b> <a href="#">Article 120(1)(a) EUTMR</a> / Article 78(1)(a) CDR	‘ <b>avocat</b> ’	<p>Persons holding the French title ‘<b>avocat</b>’, meaning a lawyer member of the bar, are entitled to act as legal practitioners before the national industrial property office pursuant to French law, and consequently entitled to act before the EUIPO in trade mark and design matters.</p> <p>These lawyers are fully entitled to act in trade mark and design matters, with an exception, that they cannot act under the title of ‘lawyer’ (avocat) and under the title of ‘professional representative’ (see below) <u>at the same time</u>. Therefore, they are not entitled to act before the EUIPO under two separate IDs (one as a lawyer, and one as a professional representative).</p>
	<b>Professional Representative (Trade Marks and Designs)</b> <a href="#">Article 120(2)(c) EUTMR</a> / Article 78(1)(b) CDR)	<b>‘Mandataires agréés’</b>  Persons on the <b>‘Liste des Conseils en propriété industrielle’</b>	<p><b>Entitlement is conditional upon possession of a special professional qualification</b></p> <p>Only persons on the ‘<b>Liste des Conseils en propriété industrielle</b>’ maintained by INPI with the speciality ‘<b>Marques, dessins et modèles</b>’ or ‘<b>Juriste</b>’ have the necessary ‘special professional qualification’ and are therefore entitled to act as professional representatives before the EUIPO.</p>



National/ Regional IP Office Office (Country)	Type of representative	National terminology	Entitlements/specific rules for representing clients in trade mark and design matters
DPMA – German Patent and Trade Mark Office (Germany)	Legal practitioner  <a href="#">Article 120(1)(a) EUTMR</a> / Article 78(1)(a) CDR	‘Rechtsanwalt’	Persons holding the German title ‘Rechtsanwalt’ , meaning a lawyer admitted to the bar, are entitled to act as legal practitioners before the national industrial property office pursuant to German law, and consequently entitled to act before the EUIPO in trade mark and design matters.
	Professional Representative (Trade Marks and Designs)  <a href="#">Article 120(2)(c) EUTMR</a> / Article 78(1)(b) CDR)	‘Patentanwalt’	Entitlement is conditional upon possession of a special professional qualification  Persons holding the title ‘Patentanwalt’ have the necessary ‘special professional qualification’ and are therefore entitled to act as professional representatives before the EUIPO.  Persons holding the titles of ‘Patentassessor’ and ‘Syndikuspateanwalt’ (§ 41a Abs. 2 PAO) do not have such qualification. They have a limited power of representation as they may only act as employee representatives for their employer, not as professional representatives.
GGE – Hellenic Republic Ministry of Economy, Infrastructure, Shipping and Tourism  Designs: Industrial Property Organisation (OBI) (Greece)	Legal practitioner  <a href="#">Article 120(1)(a) EUTMR</a> / Article 78(1)(a) CDR	‘Δικηγόρος’ (Dikigoros)	Only persons holding the title ‘Δικηγόρος’ (or ‘Dikigoros’), are entitled to act as legal practitioners before the national industrial property office pursuant to Greek law, and consequently entitled to act before the EUIPO in trade mark and design matters.
	Professional Representative (Trade Marks and Designs)  <a href="#">Article 120(2)(c) EUTMR</a> / Article 78(1)(b) CDR)	‘εγκεκριμένων αντιπροσώπων’	n/a

National/ Regional IP Office (Country)	Type of representative	National terminology	Entitlements/specific rules for representing clients in trade mark and design matters
HIPO Hungarian Intellectual Property Office (Hungary)	<p>Legal practitioner</p> <p><a href="#">Article 120(1)(a) EUTMR</a> / Article 78(1)(a) CDR</p>	‘Ügyvéd’	Persons holding the title ‘Ügyvéd’ , meaning a lawyer admitted to the bar, are entitled to act as legal practitioners before the national industrial property office pursuant to Hungarian law, and consequently entitled to act before the EUIPO in trade mark and design matters.
	<p>Professional Representative (Trade Marks and Designs)</p> <p><a href="#">Article 120(2)(c) EUTMR</a> / Article 78(1)(b) CDR)</p>	<p>‘Hivatásos képviselők’</p> <p>‘Szabadalmi ügyvivő’ (‘patent attorney’)</p>	<p><b>Entitlement is conditional upon possession of a special professional qualification</b></p> <p>Persons holding the title ‘Szabadalmi ügyvivő’ (‘patent attorney’) have the necessary ‘special professional qualification’ and are therefore entitled to act as professional representatives before the EUIPO.</p> <p>‘Legal advisors’ or ‘notaries’ are <u>not entitled</u> to act in procedures relating to industrial property matters and therefore may not be entered on the EUIPO’s list of professional representatives.</p>

National/ Regional IP Office (Country)	Type of representative	National terminology	Entitlements/specific rules for representing clients in trade mark and design matters
Icelandic Intellectual Property Office (Iceland)	<b>Legal practitioner</b>  <a href="#">Article 120(1)(a) EUTMR</a> / Article 78(1)(a) CDR	<b>‘Lögfræðingur’</b> (e. Lawyer), <b>‘Lögmaður’</b> (e. Attorney-at-Law), <b>‘Héraðsdómslögmaður’</b> (e. District Court Attorney) or <b>‘Hæstaréttarlögmaður’</b> (e. Supreme Court Attorney)	Persons holding the title <b>‘Lögfræðingur’</b> (e. Lawyer), <b>‘Lögmaður’</b> (e. Attorney-at-Law), <b>‘Héraðsdómslögmaður’</b> (e. District Court Attorney) or <b>‘Hæstaréttarlögmaður’</b> (e. Supreme Court Attorney), and therefore lawyers admitted to the bar, are entitled to act as legal practitioners before the national industrial property office pursuant to the laws of Iceland, and consequently entitled to act before the EUIPO in trade mark and design matters.
	<b>Professional Representative (Trade Marks and Designs)</b>  <a href="#">Article 120(2)(c) EUTMR</a> / Article 78(1)(b) CDR)	<b>‘Umboðsmaður’</b>	<p><b>Representation is open to anybody</b></p> <p><b>a. who has acted before the national office for at least 5 years, or</b></p> <p><b>b. who is exempt from the 5-year requirement as they are in possession of a professional qualification officially recognised in accordance with the regulations laid down by that State</b></p> <p>Any person may act before the Icelandic Patent Office. In order for this person to be entitled to act as a professional representative before the EUIPO, the person must have at least 5 years’ experience before the Icelandic Patent Office (<b>Option a</b>) .</p> <p>In addition, persons holding the title <b>‘Umboðsmaður’</b> are officially recognised as being professionally qualified to represent third parties before the national industrial property office, and are therefore not subject to the 5-year requirement to act as a professional representative before the EUIPO (<b>Option b</b>) .</p>

National/ Regional IP Office Office (Country)	Type of representative	National terminology	Entitlements/specific rules for representing clients in trade mark and design matters
Intellectual Property Office of Ireland (Ireland)	Legal practitioner  <a href="#">Article 120(1)(a) EUTMR</a> / Article 78(1)(a) CDR	‘Barrister’ or ‘Solicitor’	Persons holding the titles ‘Barrister’ or ‘Solicitor’ , are entitled to act as legal practitioners before the national industrial property office pursuant to Irish law, and consequently entitled to act before the EUIPO in trade mark and design matters.
	Professional Representative (Trade Marks and Designs)  <a href="#">Article 120(2)(c) EUTMR</a> / Article 78(1)(b) CDR)	‘Registered Trade Mark Agent’	<b>Entitlement is conditional upon possession of a special professional qualification</b>  Persons holding the title ‘Registered Trade Mark Agent’ have the necessary ‘special professional qualification’ and are therefore entitled to act as professional representatives before the EUIPO in <u>trade mark matters.</u>
UIBM – Italian Patent and Trademark Office (Italy)	Legal practitioner  <a href="#">Article 120(1)(a) EUTMR</a> / Article 78(1)(a) CDR	‘Avvocato’	Persons holding the Italian title ‘Avvocato’ , a lawyer admitted to the bar, are entitled to act as legal practitioners before the national industrial property office pursuant to Italian law, and consequently entitled to act before the EUIPO in trade mark and design matters.
	Professional Representative (Trade Marks and Designs)  <a href="#">Article 120(2)(c) EUTMR</a> / Article 78(1)(b) CDR)	‘Mandatario abilitato in Marchi’  ‘Consulente in Marchi’  ‘Consulente in Proprietà Industriale’	<b>Entitlement is conditional upon possession of a special professional qualification</b>  Persons holding the title of ‘Consulente in Marchi’ and ‘Consulente in Proprietà Industriale’ have the necessary ‘special professional qualification’ and are therefore entitled to act as professional representatives before the EUIPO in both trade mark and design matters.

National/ Regional IP Office Office (Country)	Type of representative	National terminology	Entitlements/specific rules for representing clients in trade mark and design matters
LRPV – Patent Office of the Republic of Latvia  (Latvia)	Professional Representative (Trade Marks and Designs)  <a href="#">Article 120(2)(c) EUTMR</a> / Article 78(1)(b) CDR)	‘Profesionālais patentpilvarn ieks’	<p><b>Entitlement is conditional upon possession of a special professional qualification</b></p> <p>Persons holding the title ‘<b>profesionālais patentpilvarnieks</b>’ (‘professional patent attorney’) and included on the Patent Office List of Professional Patent Attorneys are entitled to represent persons before the national industrial property office (and consequently, before the EUIPO):</p> <ul style="list-style-type: none"> <li>- in trade mark matters, if they have specialised (and passed a specific exam) in the field of trade marks;</li> <li>- in design matters, if they have specialised (and passed a specific exam) in the field of designs.</li> </ul>
Bureau of Intellectual Property Office of Economic Affairs  (Liechtenstein)	Legal practitioner  <a href="#">Article 120(1) (a) EUTMR</a> / Article 78(1)(a) CDR	‘Rechtsanwalt’	Persons holding the title ‘ <b>Rechtsanwalt</b> ’, a lawyer admitted to the bar, are entitled to act as legal practitioners before the national industrial property office pursuant to the laws of Liechtenstein, and consequently entitled to act before the EUIPO in trade mark and design matters.
	Professional Representative (Trade Marks and Designs)  <a href="#">Article 120(2)(c) EUTMR</a> / Article 78(1)(b) CDR)	‘Patentanwalt’	<p><b>Entitlement is conditional upon possession of a special professional qualification</b></p> <p>Persons holding the title ‘<b>Patentanwalt</b>’ have the necessary ‘special professional qualification’ and are therefore entitled to act as professional representatives before the EUIPO.</p>

National/ Regional IP Office (Country)	Type of representative	National terminology	Entitlements/specific rules for representing clients in trade mark and design matters
The State Bureau of the Republic of Lithuania (Lithuania)	Legal practitioner  <a href="#">Article 120(1)(a) EUTMR</a> / Article 78(1)(a) CDR	<b><u>‘praktikuojantis teisininkas’</u></b>  <b>‘Advokatas’</b>	Persons holding the title <b>‘Advokatas’</b> are entitled to act as legal practitioners before the national industrial property office pursuant to Lithuanian law, and consequently entitled to act before the EUIPO in trade mark and design matters, provided that their clients have a permanent residence in the EU.  Clients whose permanent residence is not in the EU may not be represented by a legal practitioner and must be represented by a professional representative.
	<b>Professional Representative (Trade Marks and Designs)</b>  <a href="#">Article 120(2)(c) EUTMR</a> / Article 78(1)(b) CDR)	<b>‘ Profesionalūs atstovai ’</b>  <b>‘Patentinis patikėtinis’</b>	<b>Entitlement is conditional upon possession of a special professional qualification</b>  Persons holding the title <b>‘Patentinis patikėtinis’</b> have the necessary ‘special professional qualification’ and are therefore entitled to act as professional representatives before the EUIPO.

National/ Regional IP Office (Country)	Type of representative	National terminology	Entitlements/specific rules for representing clients in trade mark and design matters
Commerce Department, Industrial Property Registrations Directorate  (Malta)	Legal practitioner  <a href="#">Article 120(1)(a) EUTMR</a> / Article 78(1)(a) CDR	<u>'prattikant legali'</u>  'Avukat' or 'Prokuratur Legali'	Persons holding the titles ' <b>Avukat</b> ' or ' <b>Prokuratur Legali</b> ', are entitled to act as legal practitioners before the national industrial property office pursuant to Maltese law, and consequently entitled to act before the EUIPO in trade mark and design matters.
	Professional Representative (Trade Marks and Designs)  <a href="#">Article 120(2)(c) EUTMR</a> / Article 78(1)(b) CDR)	'rapprezentant i professjonali'	<p><b>Representation is open to anybody</b></p> <p><b>a. who has acted before the national office for at least 5 years, or</b></p> <p><b>b. who is exempt from the 5-year requirement as they are in possession of a professional qualification officially recognised in accordance with the regulations laid down by that State</b></p> <hr/> <p>Any person, with a legal background including notaries, may act before the Maltese Intellectual Property Office. In order for this person to be entitled to act as a professional representative before the EUIPO, the person must have at least 5 years' experience before the Maltese Intellectual Property Office. <b>(Option a).</b></p>

National/ Regional IP Office (Country)	Type of representative	National terminology	Entitlements/specific rules for representing clients in trade mark and design matters
NIPO – Norwegian Industrial Property Office (Norway)	<b>Legal practitioner</b>  <a href="#">Article 120(1) (a) EUTMR</a> / Article 78(1)(a) CDR	<b>‘Advokat’ and ‘Advokatfullm ektig’</b>	<p>Persons holding the titles ‘<b>Advokat</b>’ and ‘<b>Advokatfullmektig</b>’, a lawyer admitted to the bar, are entitled to act as legal practitioners before the national industrial property office pursuant to the laws of Norway, and consequently entitled to act before the EUIPO in trade mark and design matters.</p> <p>Furthermore, if the legal practitioner acts as an attorney-at-law no power of attorney is necessary. However, if the legal practitioner acts as an employee of a company a power of attorney is necessary, even if the employee is an attorney-at-law.</p>
	<b>Professional Representative (Trade Marks and Designs)</b>  <a href="#">Article 120(2)(c) EUTMR</a> / Article 78(1)(b) CDR)		<p><b>Representation is open to anybody</b></p> <p><b>a. who has acted before the national office for at least 5 years, or</b></p> <p><b>b. who is exempt from the 5-year requirement as they are in possession of a professional qualification officially recognised in accordance with the regulations laid down by that State</b></p> <hr/> <p>Any person may act before the Norwegian Intellectual Property Office. In order for this person to represent in trade mark matters before the EUIPO, the person must have at least 5 years’ experience before the Norwegian Intellectual Property Office. <b>(Option a).</b></p>



National/ Regional IP Office (Country)	Type of representative	National terminology	Entitlements/specific rules for representing clients in trade mark and design matters
Polish Patent Office (Poland)	Legal practitioner <a href="#">Article 120(1)(a) EUTMR</a> / Article 78(1)(a) CDR	‘ <b>prawnik</b> ’  ‘ <b>Adwokat, radca prawny</b> ’	Persons holding the title ‘ <b>Adwokat, radca prawny</b> ’, meaning a lawyer admitted to the bar, are entitled to act as legal practitioners before the national industrial property office in trade mark and design matters pursuant to the laws of Poland, and consequently entitled to act before the EUIPO in trade mark and design matters.
	Professional Representative (Trade Marks and Designs) <a href="#">Article 120(2)(c) EUTMR</a> / Article 78(1)(b) CDR)	‘ <b>Zawodowi pełnomocnicy</b> ’  ‘ <b>Rzecznik Patentowy</b> ’	<b>Entitlement is conditional upon possession of a special professional qualification</b>  Persons holding the title ‘ <b>Rzecznik Patentowy</b> ’ (on the list of patent attorneys maintained by the Polish Patent Office) have the necessary ‘special professional qualification’ and are therefore entitled to act as professional representatives before the EUIPO in trade mark and design matters.

National/ Regional IP Office (Country)	Type of representative	National terminology	Entitlements/specific rules for representing clients in trade mark and design matters
INPI – Portuguese National Industrial Property Office (Portugal)	<b>Legal practitioner</b>  <a href="#">Article 120(1)(a) EUTMR</a> / Article 78(1)(a) CDR	<b>‘Profissionais de justiça’</b>  <b>‘Advogado’</b>	Persons holding the title <b>‘Advogado’</b> , a lawyer admitted to the bar, are entitled to act as legal practitioners before the national industrial property office pursuant to Portuguese law, and consequently entitled to act before the EUIPO in trade mark and design matters.
	<b>Professional Representative (Trade Marks and Designs)</b>  <a href="#">Article 120(2)(c) EUTMR</a> / Article 78(1)(b) CDR)	<b>‘mandatário autorizado’</b>  <b>‘Agentes da Propiedade Industrial’</b> and <b>‘notary’</b>	<p><b>Representation is open to anybody</b></p> <p><b>a. who has acted before the national office for at least 5 years, or</b></p> <p><b>b. who is exempt from the 5-year requirement as they are in possession of a professional qualification officially recognised in accordance with the regulations laid down by that State</b></p> <p>Any person may act before the Portuguese Institute of Industrial Property. In order for this person to be entitled to act as a professional representative before the EUIPO, the person must have at least 5 years’ experience before the Portuguese Institute of Industrial Property (<b>Option a</b>) .</p> <p>In addition, persons holding the titles of <b>‘Agentes da Propiedade Industrial’</b> and <b>‘notary’</b> are officially recognised as professionally qualified to represent third parties before the Portuguese Institute of Industrial Property and are therefore not subject to the 5-year requirement to act as a professional representative before the EUIPO (<b>Option b</b>) .</p>

National/ Regional IP Office Office (Country)	Type of representative	National terminology	Entitlements/specific rules for representing clients in trade mark and design matters
OSIM – Romanian State Office for Inventions and Trademarks (Romania)	Legal practitioner  <a href="#">Article 120(1)(a) EUTMR</a> / Article 78(1)(a) CDR	‘Avocat’	Persons holding the title of ‘ <b>Avocat</b> ’ who are also qualified as IP attorneys and members of the Romanian Chamber of Patent Attorneys, are entitled to act as legal practitioners before the national industrial property office pursuant to the laws of Romania, and consequently are entitled to act before the EUIPO in trade mark and design matters.
	Professional Representative (Trade Marks and Designs)  <a href="#">Article 120(2)(c) EUTMR</a> / Article 78(1)(b) CDR)	‘reprezentanții or autorizați’  ‘Consilier în proprietate industrială’	<b>Entitlement is conditional upon possession of a special professional qualification</b>  Persons holding the title ‘ <b>Consilier în proprietate industrială</b> ’ (who in turn must be a member of a national chamber), have the necessary ‘special professional qualification’ and are therefore entitled to act as professional representatives before the EUIPO in trade mark and design matters.
SKIPO – Industrial Property Office of the Slovak Republic (Slovakia)	Legal practitioner  <a href="#">Article 120(1)(a) EUTMR</a> / Article 78(1)(a) CDR	‘advokát’	Persons holding the title ‘ <b>advokát</b> ’ are entitled to act as legal practitioners before the national industrial property office pursuant to Slovak law, and consequently entitled to act before the EUIPO in trade mark and design matters.
	Professional Representative (Trade Marks and Designs)  <a href="#">Article 120(2)(c) EUTMR</a> / Article 78(1)(b) CDR)	‘Oprávněný zástupce’  ‘Patentový zástupce’	<b>Entitlement is conditional upon possession of a special professional qualification</b>  Persons holding the title ‘ <b>Patentový zástupce</b> ’ hold the necessary ‘special professional qualification’ and are therefore entitled to act as professional representatives before the EUIPO.

National/ Regional IP Office (Country)	Type of representative	National terminology	Entitlements/specific rules for representing clients in trade mark and design matters
SIPO Slovenian Intellectual Property Office (Slovenia)	<b>Legal practitioner</b>  <a href="#">Article 120(1)(a) EUTMR</a> / Article 78(1)(a) CDR	‘odvetnik’	Persons holding the title ‘ <b>Odvetnik</b> ’, meaning a lawyer admitted to the bar, are entitled to act as legal practitioners before the national industrial property office pursuant to laws of Slovenia, and consequently entitled to act before the EUIPO in trade mark and design matters.
	<b>Professional Representative (Trade Marks and Designs)</b>  <a href="#">Article 120(2)(c) EUTMR</a> / Article 78(1)(b) CDR	<b>‘Zastopnik za modele in znamke’</b>  (Design and trademark agent)	<b>Entitlement is conditional upon possession of a special professional qualification</b>  Persons holding the title ‘ <b>Zastopnik za modele in znamke</b> ’ (design and trademark agent) have the necessary ‘special professional qualification’, must be registered in the Register of Agents at the Slovenian Intellectual Property Office and are therefore entitled to act as a professional representative before the EUIPO.  <b>‘Notaries’</b> are explicitly excluded from representing third parties before the Slovenian Intellectual Property Office.

National/ Regional IP Office (Country)	Type of representative	National terminology	Entitlements/specific rules for representing clients in trade mark and design matters
<p>OEPM – Spanish Patent and Trademark Office (Spain)</p>	<p>Legal practitioner  <a href="#">Article 120(1)(a) EUTMR</a> / Article 78(1)(a) CDR</p>	<p>‘abogado’</p>	<p>Persons holding the title ‘<b>abogado</b>’, a lawyer admitted to the bar, are entitled to act as legal practitioners before the national industrial property office pursuant to Spanish law, and consequently entitled to act before the EUIPO in trade mark and design matters provided that the person they represent is a resident of a Member State of the EEA. Where the person that is represented is not a resident of a Member State of the EEA they may not be represented by a legal practitioner ( ‘<b>abogado</b>’ ), and must be represented by a professional representative holding the title ‘<b>Agente Oficial de la Propiedad Industrial</b>’ *</p> <p>*21/10/2021 – Spanish law in this area currently under review. See the draft law ( ‘ <a href="#">Anteproyecto de Ley de modificación de la Ley 17/2001, de 7 de diciembre, de Marcas, la Ley 20/2003, de 7 de julio, de Protección Jurídica del Diseño Industrial, y la Ley 24/2015, de 24 de julio, de Patentes.</a> ’ )</p> <p>It is possible to be an ‘<b>abogado</b>’ and an ‘<b>Agente Oficial de la Propiedad Industrial</b>’ at the same time.</p>
<p>Guidelines for Examination in the Office, Part A General rules</p>	<p>Professional Representative (Trade Marks and Designs)  <a href="#">Article 120(2)(c) EUTMR</a> / Article 78(1)(b) CDR)</p>	<p>‘Representante autorizado’  ‘Agente Oficial de la Propiedad Industrial’</p>	<p><b>Representation is open to anybody</b></p> <p><b>a. who has acted before the national office for at least 5 years, or</b></p> <p><b>b. who is exempt from the 5-year requirement as they are in possession of a professional qualification officially recognised in accordance with the regulations laid down by that State</b></p> <p>Any person may act <u>in trade mark and design matters</u> before the national industrial property office pursuant to Spanish law, provided that the person they represent is a resident of a Member State of the EU. In order for this person to be entitled to act as a professional representative before the EUIPO, the person must have at least 5 years of experience before the OEPM (<b>Option a</b>) .</p> <p>Where the person that is represented is not a resident of a Member State of the EU they must be represented by a person holding the title of ‘<b>Agente de la Propiedad Industrial</b>’</p>
<p>FINAL</p>		<p>VERSION 2.0</p>	<p>31/03/2023</p> <p>In addition, persons holding the title ‘<b>Agente de la</b></p>

National/ Regional IP Office (Country)	Type of representative	National terminology	Entitlements/specific rules for representing clients in trade mark and design matters
PRV – Swedish Patent and Registration Office (Sweden)	<b>Legal practitioner</b>  <a href="#">Article 120(1)(a) EUTMR</a> / Article 78(1)(a) CDR	<b>‘juridisk person’</b>  <b>‘Advokat’</b>	Persons holding the title <b>‘Advokat’</b> , meaning a lawyer admitted to the bar, are entitled to act as legal practitioners before the national industrial property office pursuant to Swedish law, and consequently entitled to act before the EUIPO in trade mark and design matters.
	<b>Professional Representative (Trade Marks and Designs)</b>  <a href="#">Article 120(2)(c) EUTMR</a> / Article 78(1)(b) CDR)	<b>‘Auktoriserat ombud’</b>  <b>‘Patentombud’</b>	Representation is open to anybody a. who has acted before the national office for at least 5 years, or b. who is exempt from the 5-year requirement as they are in possession of a professional qualification officially recognised in accordance with the regulations laid down by that State
			<p>Any person may act <u>in trade mark and design matters</u> before the Swedish Patent and Registration Office. In order for this person to be entitled to act as a professional representative before the EUIPO, the person must have at least 5 years’ experience before the Swedish Patent and Registration Office <b>(Option a)</b> .</p> <p>In addition, persons holding the title <b>‘Patentombud’</b> are officially recognised as being professionally qualified to represent third parties before the Swedish Patent and Registration Office <u>in trade mark and design matters</u> , and are therefore not subject to the 5-year requirement to act as professional representatives before the EUIPO <b>(Option b)</b> .</p>

## **Annex 2**

The list below shows the countries where a title exists for a person who is only entitled to represent in design matters. If the country is not on the list it means that the relevant entitlement also covers trade mark matters and so this person would not be on the special designs list.

National/Regional IP Office (Country)	National terminology	Professional Representative (exclusively Designs) Article 78(4)(c) CDR
PRH – Finnish Patent and Registration Office  (Finland)	'Mallioikeusasiamies'	<p>Representation is open to anybody</p> <p>a. who has acted before the national office for at least 5 years, or</p> <p>b. who is exempt from the 5-year requirement as they are in possession of a professional qualification officially recognised in accordance with the regulations laid down by that State</p> <p>Any natural or legal person can act as a representative <u>in design matters</u> before the national industrial property office. In order for this person to be entitled to act as a representative before EUIPO, the person must have at least 5 years' experience before the national industrial property office (<b>Option a</b>).</p> <p>Persons holding the title '<b>Mallioikeusasiamies</b>' are officially recognised as being professionally qualified to represent third parties before the Finnish Patent and Registration Office <u>in design matters</u>, and therefore are not subject to the 5-year requirement to act as professional representative before the EUIPO (<b>Option b</b>).</p>



National/Regional IP Office (Country)	National terminology	Professional Representative (exclusively Designs) Article 78(4)(c) CDR
Intellectual Property Office of Ireland  (Ireland)	'Registered Patent Agents'	<p>Entitlement is conditional upon possession of a special professional qualification</p> <p>Only 'Registered Patent Agents' have the necessary 'special professional qualification' and are therefore entitled to act as professional representatives before the EUIPO in <u>design matters</u>.</p>
UIBM – Italian Patent and Trademark Office  (Italy)	'Consulente in brevetti'	<p>Entitlement is conditional upon possession of a special professional qualification</p> <p>Persons holding the title of 'Consulente in brevetti' have the necessary 'special professional qualification' and are therefore entitled to act as professional representatives before the EUIPO in <u>design matters only</u>.</p>
LRPV – Patent Office of the Republic of Latvia  (Latvia)	'Patentpilnvarotais dizainparaugu lietas'	<p>Entitlement is conditional upon possession of a special professional qualification</p> <p>Persons holding the title of 'Patentpilnvarotais dizainparaugu lietas' have the necessary 'special professional qualification' and are therefore entitled to act as professional representatives before the EUIPO in <u>design matters only</u>.</p>

National/Regional IP Office (Country)	National terminology	Professional Representative (exclusively Designs) Article 78(4)(c) CDR
<p>PRV – Swedish Patent and Registration Office (Sweden)</p>	<p>‘Varumaerkesombud’</p>	<p>Representation is open to anybody</p> <p>a. who has acted before the national office for at least 5 years, or</p> <p>b. who is exempt from the 5-year requirement as they are in possession of a professional qualification officially recognised in accordance with the regulations laid down by that State</p> <p>Any person may act <u>in design matters</u> before the Swedish Patent and Registration Office. For this person to be entitled to act as a professional representative before the EUIPO, the person must have at least 5 years’ experience before the Swedish Patent and Registration Office (<b>Option a</b>).</p> <p>Persons holding the title ‘<b>Varumaerkesombud</b>’ are officially recognised as being professionally qualified to represent third parties before the Swedish Patent and Registration Office <u>in design matters</u>, and therefore are not subject to the 5-year requirement to act as professional representatives before the EUIPO (<b>Option b</b>).</p>

***GUIDELINES FOR EXAMINATION OF  
EUROPEAN UNION TRADE MARKS***

***EUROPEAN UNION  
INTELLECTUAL PROPERTY OFFICE  
(EUIPO)***

***Part A***

***General rules***

***Section 6***

***Revocation of decisions, cancellation of  
entries in the register and correction of  
errors***

## Table of Contents

<b>1 Introduction.....</b>	<b>142</b>
<b>2 Revocation of decisions and cancellation of entries in the Register....</b>	<b>142</b>
<b>2.1 General remarks.....</b>	<b>142</b>
<b>2.2 Assessment.....</b>	<b>143</b>
2.2.1 Nature of the error.....	143
2.2.2 One-year deadline.....	144
2.2.3 Decision against which an appeal is pending.....	144
<b>2.3 Procedure – distinction between where only one party or more parties are affected.....</b>	<b>144</b>
2.3.1 Procedures when only one party is affected.....	145
2.3.2 Procedure when more than one party is affected.....	145
<b>3 Correction of errors in the publication of the application.....</b>	<b>147</b>
<b>3.1 General remarks.....</b>	<b>147</b>
<b>3.2 Procedure.....</b>	<b>147</b>
<b>4 Correction of errors in decisions, EUTM registrations or the publication of EUTM registrations.....</b>	<b>148</b>
<b>4.1 General remarks.....</b>	<b>148</b>
<b>4.2 Assessment.....</b>	<b>148</b>
<b>4.3 Procedure.....</b>	<b>149</b>

## 1 Introduction

The Office will remedy errors attributable to it, in particular, in the following ways:

- revocation of decisions and cancellation of entries in the Register ([Article 103 EUTMR](#), see [paragraph 2](#));
- correction of errors in the publication of an EUTM application ([Article 44\(3\) EUTMR](#), see [paragraph 3](#));
- correction of errors in decisions, EUTM registrations or the publication of EUTM registrations ([Article 102 EUTMR](#), see [paragraph 4](#)).

This section deals with the assessment and procedural aspects of the provisions above.

The distinction between revocation under [Article 103 EUTMR](#) and correction under [Article 102\(1\) EUTMR](#) relates to the nature of the errors. The types of errors covered by Article 103 EUTMR require a new analysis of the case while those covered by Article 102(1) EUTMR do not. As to the effects, revocation annuls a decision whereas the correction of errors does not affect the validity of the decision and does not open a new appeal period (28/05/2020, [T-724/18](#) and [T-184/19](#), AUREA BIOLABS (fig.) / Aurea et al., EU:T:2020:227, § 28-30; 22/09/2021, [T-169/20](#), Marina Yachting, EU:T:2021:609, § 111).

The Office's interpretation of [Article 44\(3\) EUTMR](#) is that it covers errors that are so obvious they do not require a new assessment or analysis. These corrections pursuant to [Article 44\(3\) EUTMR](#) can only apply to the publication of EUTM applications whereas corrections under [Article 102\(1\) EUTMR](#) can apply to decisions and to the registration and publication of EUTM registrations.

This section does **not** apply to registered Community designs (RCDs).

## 2 Revocation of decisions and cancellation of entries in the Register

### 2.1 General remarks

[Article 103 EUTMR](#)

[Article 70 EUTMDR](#)

[Article 103 EUTMR](#) provides for the cancellation of entries in the Register and revocation of decisions containing obvious errors attributable to the Office.

The revocation or cancellation procedure may be initiated by the Office on its own motion or at the request of one of the parties to the proceedings.

A decision can only be revoked by another decision. Likewise, cancellations of entries in the Register also require a revocation decision. Decisions on revocation/cancellation are made by the department that made the entry or took the decision.

The **effect** of the revocation of a decision or of the cancellation of an entry in the Register is that the decision or entry is deemed never to have existed. The file is returned to the procedural stage it was at before the erroneous decision or entry was made.

## 2.2 Assessment

### 2.2.1 Nature of the error

The Office must verify, firstly, whether the decision or entry contains an obvious error.

An error is obvious if it **does not allow the operative part of that decision or that entry to be maintained without a new analysis**, which will be carried out subsequently by the department that took that decision or made that entry (22/09/2021, [T-169/20](#), Marina yachting, EU:T:2021:609, § 111).

Obvious errors are not limited to procedural errors (22/09/2021, [T-169/20](#), Marina yachting, EU:T:2021:609, § 110). Therefore, 'obvious error' covers flagrant procedural violations, an obvious distortion of facts or obvious errors of substance, which require a new analysis of the case.

The following is a non-exhaustive list of examples of obvious errors giving rise to erroneous decisions that may be revoked or erroneous entries that may be cancelled.

- The opposition has been found admissible even though some admissibility requirements were not met (18/10/2012, [C-402/11 P](#), Redtube, EU:C:2012:649).
- A decision refusing the EUTM application on absolute grounds is notified in the absence of any observations from the applicant in reply to the objection before the expiry of the time limit for submitting observations, or ignoring the observations that the applicant submitted on time.
- The EUTM is refused on absolute grounds, ignoring a valid subsidiary claim to prove acquired distinctiveness or ignoring the evidence of acquired distinctiveness duly submitted ([Article 7\(3\) EUTMR](#)).
- The EUTM is refused by the Opposition Division, ignoring a request for proof of use or without dealing with the issue of proof of use.
- The opposition is rejected on the basis of lack of proof of use but the opponent was not expressly given a time limit for submitting proof of use, or proof of use was submitted on time and was overlooked.
- The opposition decision was rendered while the proceedings were suspended or interrupted or, more generally, while a time limit for one of the parties was still running.

- Any breach of the right to be heard (observations not forwarded to the other party when that party should have been given a time limit to reply pursuant to the Regulation or Office practice).
- When closing a file due to a limitation of the contested EUTM application or a withdrawal, the Office has issued a decision on costs, overlooking an agreement on costs between both parties that was on file at the time.

### 2.2.2 One-year deadline

The Office must verify, secondly, whether 1 year has passed since notification of the decision or entry in the Register.

[Article 103\(2\) EUTMR](#) provides that revocation/cancellation must be effected within 1 year of the date on which the erroneous decision was taken or the erroneous entry was made in the Register, after consultation with the parties to the proceedings and any proprietor of rights to the EU trade mark in question that are entered in the Register. The revocation/cancellation is deemed effected on the date of notification of the decision on revocation/cancellation, regardless of any appeal.

Any request for revocation/cancellation received after 1 year of the date on which the erroneous decision was taken or the erroneous entry was made in the Register will be rejected as inadmissible because [Article 103\(2\) EUTMR](#) provides that revocation/cancellation must be effected within 1 year of the relevant error. Likewise, even if a request has been received within that time limit, it will be rejected if the Office cannot carry it out before the expiry of the 1-year period, irrespective of the reason why the request could not be effected on time.

In light of the fixed time limit, any party to the proceedings should inform the Office about the obvious error identified without any delay, particularly where an adverse party needs to be consulted. In any event, irrespective of the time remaining before the 1-year deadline, the Office will always initiate the procedure for revocation/cancellation if it becomes aware of an obvious error requiring revocation or cancellation, and will do its utmost to conduct an expedient procedure to conclude on time.

### 2.2.3 Decision against which an appeal is pending

An appeal filed against a decision containing an obvious error is not an obstacle to revocation. [Article 103\(4\) EUTMR](#) provides that the appeal proceedings will become devoid of purpose upon revocation of an erroneous decision. The department competent to decide on the revocation will inform the Boards of Appeal promptly if it is considering a revocation and will also inform them of the outcome of its deliberations.

## 2.3 Procedure – distinction between where only one party or more parties are affected

The procedure where only **one party** is affected is described in [paragraph 2.3.1](#).

One example is when the EUTM applicant's observations have not been taken into account when refusing the EUTM application.

If revocation of a decision is likely to affect **more than one party**, the procedure described in [paragraph 2.3.2](#) must be followed. For example, where the Office overlooked a request for proof of use, more than one party will be affected by the revocation of a decision in opposition proceedings.

Errors in registering a transfer of ownership also affect more than one party. While the procedure for recordal is essentially *ex parte*, the Office will determine if more than one party is affected for the purposes of the procedure for cancellation of the erroneous entry: the new owner, the old owner and the third party that should have been entered in the Register, as the case may be.

### 2.3.1 Procedures when only one party is affected

#### a) Error found by the Office

If the Office itself finds that an error has been made, it informs the party of its intention to revoke the decision/cancel the entry and sets a time limit of one month for observations. The notice must state the reasons for the revocation/cancellation.

If the party agrees or does not submit any observations, the Office revokes the decision/cancels the entry.

If the party does not agree to revocation or cancellation, a formal decision has to be taken, which is subject to the usual requirements described in [the Guidelines, Part A, General Rules, Section 2, General Principles to be Respected in the Proceedings, paragraph 6](#).

#### b) Error notified by the affected party

If the party affected by an error informs the Office in writing of the error, there is no need to ask for observations. In these cases, it must be determined whether revocation/cancellation is justified and possible. If so, the decision or entry in the Register is revoked/cancelled. If the Office finds that there are no reasons for revocation/cancellation or it is no longer possible, it informs the party accordingly, giving appropriate reasons.

### 2.3.2 Procedure when more than one party is affected

#### a) Error found by the Office

If the Office itself finds that an error has been made, it informs the parties of its intention to revoke the decision / cancel the entry and sets a time limit of 1 month for observations.

If the parties agree or do not submit any observations in reply, the Office revokes the decision / cancels the entry.

If the party that benefited from the error does not agree to the revocation/cancellation, a reasoned decision has to be taken, which is subject to the usual requirements



described in the Guidelines [Part A, General rules, Section 2, General principles to be respected in the proceedings, paragraph 6.](#)

**b) Error notified by one of the parties**

**If the party adversely affected by an error informs the Office** in writing, it must be determined whether revocation/cancellation is justified and possible. If so, the Office notifies the party that benefited from the error of its intention to revoke/cancel and sets a time limit of 1 month for observations (sending a copy of the notification to the first party for information purposes).

If the party that benefited from the error agrees or does not submit any observations in reply, the Office revokes the decision/cancels the entry.

If the party that benefited from the error does not agree to revocation or cancellation, a reasoned decision has to be taken, which is subject to the usual requirements described in the Guidelines [Part A, General rules, Section 2, General principles to be respected in the proceedings, paragraph 6.](#)

**If the party that benefited from the error informs the Office** in writing, it must be determined whether revocation/cancellation is justified and possible. If so, the party adversely affected by the error must be informed accordingly. As revocation/cancellation will be to the latter's advantage, the decision can be revoked or the entry cancelled at the same time as the letter is sent (to both parties). There is no need for the party that benefited from the error to submit observations, as its letter informing the Office of the error can be taken as its agreement to revocation/cancellation. Likewise, there is no need to hear the party adversely affected, as a revocation/cancellation is made in its favour.

Finally, once a revocation or cancellation has become final, it must be published if a wrong entry in the Register has already been published.

If the Office finds that, despite the information received from either party, there are no reasons to revoke a decision / cancel an entry, or it is no longer possible, it informs the parties accordingly, giving appropriate reasons (and forwarding the original request to the other party for information purposes).

### 3 Correction of errors in the publication of the application

[Article 44\(3\) and \(4\) EUTMR](#)

[Article 46\(2\) EUTMR](#)

[Article 11 EUTMDR](#)

#### 3.1 General remarks

[Article 44\(1\) EUTMR](#) states that EUTM applications that have not been refused on absolute grounds must be published.

[Article 44\(3\) and \(4\) EUTMR](#) refer to the correction of errors attributable to the Office in the publication of the application.

The following are examples of errors that can be corrected:

- The EUTM has been published for less classes than applied for.
- Sign 'x' was applied for but the publication refers to sign 'y'.
- The list of goods and services published is wrong.

#### 3.2 Procedure

Where the publication of the application contains an **error attributable to the Office**, the Office must, of its own motion, or at the request of the applicant, correct the error and publish the correction.

There is no **time limit** for corrections pursuant to [Article 44\(3\) and \(4\) EUTMR](#).

Where the correction is requested by the applicant, the request must contain:

- the file number of the EUTM application;
- the name and address of the applicant or the ID number and the applicant's name;
- the indication of the element to be corrected and a corrected version of the element.

If the Office verifies the existence of an error, the applicant is notified of the correction and the EUTM and the correction are published.

Corrections of errors in EUTM applications pursuant to [Article 44\(3\) and \(4\) EUTMR](#) that do not require republication of the application for opposition purposes are published in Section B.2 of the Bulletin. Corrections that do require republication of the application for opposition purposes are published in Section A.2.

Republication for opposition purposes will be required where a correction involves changes to the representation of the mark or a broadening of the list of goods and

services already published. For other corrections, republication must be decided on a case-by-case basis.

For more information on the effect of republication on pending opposition proceedings, see the Guidelines, [Part C, Opposition, Section 1, Opposition proceedings, paragraph 7.1.2](#).

The above paragraphs refer to the correction of errors attributable to the Office only. For amendments to an EUTM application on the applicant's own initiative, see the Guidelines, [Part B, Examination, Section 1, Proceedings, paragraph 5](#).

## 4 Correction of errors in decisions, EUTM registrations or the publication of EUTM registrations

[Article 55 EUTMR](#)

[Article 102 EUTMR](#)

### 4.1 General remarks

According to [Article 102\(1\) EUTMR](#), the Office will correct any **linguistic errors or errors of transcription** and **manifest oversights** in its decisions, or **technical errors** attributable to it in registering an EUTM or in publishing the registration.

For the difference between these corrections under [Article 102\(1\) EUTMR](#) and corrections of the publication of the application under [Article 44\(3\) EUTMR](#) or the revocation/cancellation of entries under [Article 103 EUTMR](#), see [paragraph 1](#).

### 4.2 Assessment

As there is no **time limit**, errors under [Article 102\(1\) EUTMR](#) can be corrected any time.

It must be verified whether the error to be corrected is a **linguistic error or an error of transcription, a manifest oversight or a technical error**.

Corrections in decisions under [Article 102\(1\) EUTMR](#) are limited to obvious formal mistakes which affect the form of the decision only, not its scope or substance. This is true of errors which are so obvious that no wording other than the corrected wording could be intended and errors which do not justify invalidating or revoking the decision marred by them. This includes errors that constitute incongruous elements in a decision which is otherwise consistent and unambiguous (28/05/2020, [T-724/18](#) & [T-184/19](#), AUREA BIOLABS (fig.) / Aurea et al., EU:T:2020:227, § 29, 33-34). Even the dictum of a decision may be corrected if no wording other than that resulting from the correction could have been envisaged.

By contrast, the adoption of a revocation decision is justified by errors which do not allow the operative part of the decision at issue to be maintained without a new

analysis. This is true of errors affecting the award of costs, those relating to the right to be heard or those concerning the obligation to state reasons (28/05/2020, [T-724/18](#) & [T-184/19](#), AUREA BIOLABS (fig.) / Aurea et al., EU:T:2020:227, § 30).

The nature of the errors and oversights that can be corrected pursuant to [Article 102\(1\) EUTMR](#) means that an appeal against a decision is not an obstacle to the correction of the decision by the first instance department that adopted it. Nevertheless, the relevant department will inform the Boards of Appeal promptly if it is considering a correction, as well as informing them of the outcome of its deliberations (i.e. whether any correction has been made) so this can be taken into account in the appeal proceedings.

Additionally, [Article 102\(1\) EUTMR](#) refers to errors in the **registration of an EUTM or in any entry made in the Register** in accordance with [Article 111\(2\) and \(3\) EUTMR](#) or a Decision of the Executive Director pursuant to [Article 111\(4\) EUTMR](#), and to errors in the publication of those entries in the Register. As set out above, the correction of these errors should not require a new analysis of the case.

The following are examples of errors that can be corrected:

- the EUTM is registered without taking a limitation into consideration;
- the EUTM is registered despite having been previously withdrawn;
- the EUTM is registered despite a deficiency, e.g. in the payment of the application fees;
- the EUTM is registered despite a pending or successful opposition;
- the dictum of the decision lists the wrong classes of goods or services even though the correct ones are stated in the body of the decision;
- the dictum of the decision based on Article 8(1)(b) EUTMR upholds the opposition whereas the body of the decision finds that the opposition is unfounded;
- where, in the case of a partially upheld opposition, based on Article 8(1)(b) EUTMR, the dictum does not list all the goods/services for which the EUTM should be rejected according to the comparison in the body of the decision.

### 4.3 Procedure

Where there is an error attributable to the Office, the latter corrects it either of its own motion (where the Office itself has become aware of the error) or at the request of a party.

When the correction of errors in the registration of an EUTM or in the publication of the registration is requested by the proprietor, the request must contain:

- the registration number of the EUTM;
- the name and address of the proprietor or the ID number and the proprietor's name;
- the indication of the element to be corrected and the element in its corrected version.

Unlike in revocation, [Article 102 EUTMR](#) does not establish any procedural steps. A corrigendum will be sent to the affected party/parties. The accompanying letter must briefly explain the corrections.

a) Correction in registrations

Corrections to entries in the Register must be published pursuant to [Article 102\(3\) EUTMR](#) and [Article 116\(1\)\(a\) EUTMR](#). Corrections of errors in Register entries are published in subsection C.10. of the Bulletin.

No corrections need to be published pursuant to [Article 102 EUTMR](#) when the initial publication was in the wrong section of the Bulletin. The legal effect of the publication under [Article 11\(1\) EUTMR](#) remains the same regardless of whether the publication is made in Part B.1 or Part B.2 of the Bulletin.

b) Correction in decisions

If a correction is made in a decision, the corrigendum is made publicly available in the Office's [eSearch Case Law](#) database.

The date of the decision **remains unchanged after correction. Therefore, the time limit for appeal is not affected.**

c) Correction in notifications other than decisions

Errors in notifications other than decisions can be remedied by sending a corrected notification indicating that the latter replaces and annuls the one previously sent.

***GUIDELINES FOR EXAMINATION***  
***EUROPEAN UNION***  
***INTELLECTUAL PROPERTY OFFICE***  
***(EUIPO)***

***Part A***

***General rules***

***Section 7***

***Revision***

## Table of Contents

<b>1 General principles.....</b>	<b>153</b>
<b>2 Revision of decisions.....</b>	<b>153</b>
<b>2.1 No rectification of the appealed decision.....</b>	<b>154</b>
<b>2.2 Rectification of the appealed decision.....</b>	<b>154</b>
2.2.1 Contents of the decision on rectification.....	155
2.2.2 Communication of the decision on rectification.....	155

## 1 General principles

[Article 66 EUTMR](#)

Article 55 CDR

[Article 69 EUTMR](#)

Article 58 CDR

[Article 34\(1\) EUTMDR](#)

Revision only occurs in *ex parte* cases, that is to say, those that involve only one party.

Revision enables the first-instance decision taker to rectify a decision that has been appealed if the appeal is admissible and well founded. The purpose of revision is to avoid the Boards of Appeal ruling on appeals against decisions for which a need for rectification has been recognised by the department that took the decision.

Revision proceedings can take place where an appeal has been lodged against a decision for which the Boards of Appeal are competent.

The Boards of Appeal send the appealed decision back to the department that took the decision in order for it to be revised.

A decision can only be rectified within 1 month of receipt of the statement of grounds of appeal.

Since revision requires a pending appeal, it will not take place when the appeal is withdrawn before a decision on revision could be taken.

## 2 Revision of decisions

[Article 69 EUTMR](#)

Article 58 CDR

Articles [23\(1\)](#), [33](#) and [34\(1\) EUTMDR](#)

Article 35(1) and (2) CDIR

In *ex parte* proceedings, once the Board of Appeal considers the appeal to be admissible, the Registrar of the Boards of Appeal sends the appeal documents (the notice of appeal and the statement of grounds) to the department that adopted the appealed decision for revision.

The department concerned examines whether the appealed decision should be rectified or not.



Since the revision may result in a rectification of the appealed decision only where the appeal is admissible and well founded, the competent department must also verify that the following conditions are met:

- the appeal is admissible ([Article 23\(1\) EUTMDR](#) or Article 35(1) and (2) CDIR); and
- the appeal is ‘well founded’ within the scope of the appeal, on substantive or procedural grounds.

The relevant date for assessing whether the appeal is ‘well founded’ is that on which the competent department took the appealed decision.

The appealed decision will not be rectified when the appellant attempts to remedy deficiencies for the first time before the Boards of Appeal.

## 2.1 No rectification of the appealed decision

[Article 69\(2\) EUTMR](#)

Article 58(2) CDR

When the competent department concludes that the conditions for rectifying the appealed decision are not met, and at the latest upon expiry of 1 month from the receipt of the statement of grounds of appeal, it remits the case to the Boards of Appeal without any comment or statement.

No formal decision refusing the rectification of the appealed decision is issued and the proceedings will continue before the Boards of Appeal.

## 2.2 Rectification of the appealed decision

[Article 69\(1\) and \(2\) EUTMR](#)

Article [33\(b\)](#) and [34\(1\) and \(2\)](#) EUTMDR

Article 58(1) and (2) CDR

Articles 37 CDIR

When the competent department concludes that the conditions for rectifying the appealed decision are met, it will inform the Board of Appeal thereof without delay.

In addition, the following procedural actions will be taken:

- within 1 month of the Board of Appeal submitting the statement of grounds of the appeal to the competent department, this department must take a decision repealing the appealed decision in its entirety (‘decision on rectification’);
- the competent department takes a new decision on the merits either together with the decision on rectification or at a later stage;
- the Board of Appeal decides on the closure of the appeal.

### 2.2.1 Contents of the decision on rectification

Depending on the reasons found by the competent department to rectify the appealed decision, the outcome may lead to one of the following situations.

1. A new interaction with the party (for example, because a request for an extension of time had been overlooked).

In this case, the Office will set new time limits for the party, and a new decision on the merits will be adopted at a later stage.

2. A new decision on the merits taken directly without any interaction with the party (for example, if evidence of acquired distinctiveness was on file but was not addressed in the appealed decision).

In this case, the new decision on the merits can be issued either together with the decision on rectification or at a later stage.

Taking this into account, the decision on rectification must contain the following:

1. the reasons that justify the rectification of the initial decision;
2. a statement that the initial decision (i.e. the appealed decision) is deemed to have been repealed;
3. a statement establishing the procedural situation of the examination proceedings, that is:
  - a statement that a decision on the merits will be taken at a later stage, and a statement that the decision on rectification can only be appealed together with the later decision on the merits;
  - or
  - a statement that a new decision on the merits of the case replacing the initial decision is herewith adopted, and a statement that an appeal can be filed within 2 months;
4. in design proceedings, an order to reimburse the appeal fee.

The new decision on the merits may set the proceedings back and allow for a new examination, which may go beyond the scope of the initial appeal. The new decision on the merits may result in the same outcome.

### 2.2.2 Communication of the decision on rectification

Once the decision on rectification is taken, the competent department must promptly inform the Registrar of the Boards of Appeal. The Board of Appeal decides on the closure of the appeal. The appeal fee will be reimbursed.

**GUIDELINES FOR EXAMINATION**

**EUROPEAN UNION**  
**INTELLECTUAL PROPERTY OFFICE**  
**(EUIPO)**

***Part A***

***General rules***

***Section 8***

***Restitutio in integrum***

## Table of Contents

<b>1 General principles.....</b>	<b>158</b>
<b>2 Criteria for granting <i>restitutio in integrum</i>.....</b>	<b>158</b>
2.1 The condition of ‘all due care required by the circumstances’.....	158
2.2 Loss of rights or means of redress caused directly by failure to meet the time limit.....	161
<b>3 Procedural Aspects.....</b>	<b>162</b>
3.1 Proceedings to which <i>restitutio in integrum</i> applies.....	162
3.2 Parties.....	162
3.3 Time limit for national offices to forward an application to the Office....	163
3.4 Time limits excluded from <i>restitutio in integrum</i> .....	163
3.5 Effect of <i>restitutio in integrum</i> .....	164
3.6 Time limits.....	164
3.7 Fees.....	165
3.8 Languages and translations.....	166
3.9 Particulars and evidence.....	166
3.10 Competence.....	167
3.11 Publications.....	167
3.12 Decision, role of other parties in <i>restitutio in integrum</i> proceedings....	168
3.13 <i>Restitutio in integrum</i> in the event of renewals.....	168
<b>4 Third-Party Proceedings.....</b>	<b>169</b>

## 1 General principles

[Article 104 EUTMR](#)

Article 67 CDR

Parties to proceedings before the Office may have their rights reinstated (*restitutio in integrum*) if they were unable to meet a time limit vis-à-vis the Office despite taking all due care required by the circumstances, provided that the failure to meet the time limit had the direct consequence, by virtue of the provisions of the Regulations, of causing a loss of rights or loss of means of redress (28/06/2012, [T-314/10](#), Cook's, EU:T:2012:329, § 16-17; 26/09/2017, [T-84/16](#), widiba (fig.) / ING DiBa (fig.) et al., EU:T:2017:661, § 27).

Observing time limits is a matter of public policy, and serves the requirements of legal certainty and the need to avoid any discrimination or arbitrary treatment in the administration of justice. Derogations from these rules can only be made in exceptional circumstances (23/09/2020, [T-557/19](#), 7SEVEN (fig.), EU:T:2020:450, § 34). Consequently, the conditions for the application of *restitutio in integrum* have to be interpreted strictly (19/09/2012, [T-267/11](#), VR, EU:T:2012:446, § 35; 16/06/2015, [T-585/13](#), JBG Gauff Ingenieure (fig.) / Gauff et al., EU:T:2015:386, § 25).

*Restitutio in integrum* is only available upon application to the Office and is subject to the payment of a fee (see [paragraph 3.7](#)).

The Office is under no obligation to inform or advise a party to the proceedings before it to pursue any particular legal remedy, including *restitutio in integrum* (06/10/2021, [T-635/20](#), Juvéderm vybrance, EU:T:2021:656, § 36).

## 2 Criteria for granting *restitutio in integrum*

There are two requirements for *restitutio in integrum*:

1. that the party has exercised all due care required by the circumstances; and
2. that the non-observance (of a deadline) by the party has the direct consequence of causing the loss of a right or means of redress.

### 2.1 The condition of 'all due care required by the circumstances'

Rights will be re-established only under exceptional circumstances that cannot be predicted from experience (13/05/2009, [T-136/08](#), Aurelia, EU:T:2009:155, § 26) and are therefore unpredictable and involuntary.

If the party is represented, the representative's failure to take all due care is attributable to the party that they represent (19/09/2012, [T-267/11](#), VR, EU:T:2012:446, § 40;

16/12/2020, [T-3/20](#), Canoleum / Marmoleum, EU:T:2020:606, § 45). The question whether the party has exercised the necessary vigilance to mitigate the errors of its representative causing the loss of a right cannot excuse the representative (19/09/2012, [T-267/11](#), VR, EU:T:2012:446, § 41; 31/01/2019, [T-604/17](#), REJECTION OF RESTITUTIO IN INTEGRUM (RECORDAL), EU:T:2019:42, § 21).

**1. Examples of where the ‘all due care’ requirement has been fulfilled**

Failure to deliver mail

In principle, failure to deliver by postal or delivery service does not involve any lack of due care by the party concerned (25/06/2012, [R 1928/2011-4](#), SUN PARK HOLIDAYS / SUNPARKS). However, it is up to the parties’ representative to at least find out in advance from the delivery company what the usual delivery times are (for example, in the case of letters sent from Germany to Spain in the decision of 04/05/2011, [R 2138/2010-1](#), YELLOWLINE / Yello).

Errors of the Office and their repercussions

The degree of due care that the parties must demonstrate in order to have their rights re-established must be determined in the light of all the relevant circumstances. Relevant circumstances may include a relevant error made by the Office and its repercussions. Thus, even though the party concerned has failed to take all due care, a relevant error by the Office may result in the granting of *restitutio in integrum* (25/04/2012, [T-326/11](#), BrainLAB, EU:T:2012:202, § 57, 59).

Force majeure

Circumstances such as natural disasters and general strikes are regarded as fulfilling the requirement for all due care. Another unpredictable event may be when all the employees of a law firm representing the party concerned are factually prevented from accessing the physical files and, consequently, from taking any further action to observe the time limit (14/06/2021, [R 735/2021-4](#), MOOI MUSEUM OF OPTICAL ILLUSIONS (fig.) / MUSEUM OF ILLUSIONS (fig.) et al., § 15).

**2. Examples of where the ‘all due care’ requirement has not been fulfilled**

**a. Errors in administration or organisation**

Delegation of tasks

The party to proceedings who delegates the administrative tasks relating thereto must ensure that the person chosen provides the necessary guarantees to ensure the tasks are properly carried out (13/09/2011, [T-397/10](#), Sport shoe, EU:T:2011:464, § 25).

Management of files

Errors in the management of files caused by the representative’s employees or by the computerised system itself are predictable. Consequently, due care would require a system for monitoring and detecting any such errors (13/05/2009, [T-136/08](#), Aurelia, EU:T:2009:155, § 18; 26/09/2017, [T-84/16](#), widiba (fig.) / ING DiBa (fig.) et al., EU:T:2017:661, § 39; 21/04/2021, [T-382/20](#), Table knives, forks and spoons, EU:T:2021:210, § 31-34).

For example, an error by the Renewals Department Manager of a private company, who monitors staff performance daily, does not constitute an exceptional event (24/04/2013, [R 1728/2012-3](#), LIFTING DEVICES (PART OF-)).

#### Workload

The exceptional workload and organisational strains to which the applicants claim they were subject are, in principle, irrelevant (20/06/2001, [T-146/00](#), Dakota, EU:T:2001:168, § 62; 20/04/2010, [T-187/08](#), Dog, EU:T:2010:150, § 34).

#### Absence of a key member of the accounts department

The absence of a key member of the Accounts Department cannot be regarded as an exceptional or unpredictable event (10/04/2013, [R 2071/2012-5](#), STARFORCE).

#### Delay in instructions

Delay by the owner in providing instructions is not an exceptional event (15/04/2011, [R 1439/2010-4](#), SUBSTRAL NUTRI+MAX / NUTRIMIX).

#### Financial problems / closure of business

Financial problems at the proprietor's business, its closure and the loss of jobs cannot be accepted as reasons preventing the proprietor from being able to observe the time limit to renew its European Union trade mark (31/03/2011, [R 1397/2010-1](#), CAPTAIN).

### **b. Duties and errors of professional representatives**

#### Legal errors and misunderstandings

Legal errors by a professional representative do not warrant *restitutio in integrum* (16/11/2010, [R 1498/2010-4](#), REGINE'S / REGINA DETECHA, CH.V.D). A misunderstanding of the applicable law may not, as a matter of principle, be regarded as an 'obstacle' to compliance with a time limit (14/06/2012, [R 2235/2011-1](#), KA; 28/04/2020, [R 2391/2019-5](#), STAHL (fig.)).

#### Consideration of time limits

The careful consideration of the time limits is part of the basic duties of professional representatives, including the careful checking of the facsimile transmission report after submitting documents (26/06/2017, [R 748/2017-2](#), GIBBS S3 Business, Technology and Community Partner (fig.) / STHREE et al., § 43). A clerical error in entering a deadline cannot be regarded as an exceptional or unpredictable event (31/01/2013, [R 265/2012-1](#), KANSI / Kanz).

#### Calculation of time limits

An erroneous calculation of the time limit does not constitute an exceptional event that cannot be predicted from experience (05/07/2013, [R 194/2011-4](#), PAYENGINE / SP ENGINE). The correct calculation of the deadline is governed by the EUTMR and the EUTMDR, and the party cannot justify its non-compliance with the time limit by the fact that the deadline was not displayed in the Office's online database (03/09/2019, [R 500/2019-5](#), minimon (fig.) / Minimensch, § 36).

The same rule applies to Community designs where the relevant provisions are in the CDR and the CDIR.

c. **Clerical mistakes**

Deletion of a deadline

The deletion of a deadline by an assistant is not unpredictable (28/06/2010, [R 268/2010-2](#), ORION).

Bank transfer error

An error in the transmission of the data to a bank or an error made by a bank in the execution of the transfer to the Office cannot be regarded as exceptional or unforeseeable. The party to the proceedings before the Office is under an obligation to anticipate those circumstances and to take the necessary precautions to ensure that the payment is made within the established time period (13/10/2021, [T-732/20](#), Crystal, EU:T:2021:696, § 29-31).

## 2.2 Loss of rights or means of redress caused directly by failure to meet the time limit

[Article 104\(1\) EUTMR](#)

Failure to meet the time limit must have had the direct consequence of causing the loss of rights or means of redress.

Articles [47\(2\)](#), [95\(2\)](#) and [96\(1\)](#) EUTMR

[Article 7](#), [Article 8\(1\) to \(4\)](#), [\(7\) and \(8\)](#), [Article 14](#) and [Article 17\(1\) and \(2\)](#) EUTMDR

This is not the case where the Regulations offer procedural options that parties to proceedings are free to use, such as requesting an oral hearing, requesting that the opponent prove genuine use of its earlier mark, or applying for an extension of the cooling-off period, pursuant to [Article 7 EUTMDR](#). The cooling-off period itself is not subject to *restitutio in integrum* either because it is not a time limit within which a party must perform an action.

[Article 38\(1\)](#), [Articles 41 and 42](#), and [Article 155\(1\) EUTMR](#)

However, *restitutio in integrum* does apply to the late response to an examiner's notification of provisional refusal if the application is not rectified by the time limit specified because, in this case, there is a direct relationship between failure to meet the time limit and possible refusal.

Restitutio in integrum is also available for the late submission of facts and arguments and late filing of observations on the other party's statements in inter partes proceedings if and when the Office refuses to take them into account as being filed



late. The loss of rights in this case involves the exclusion of these submissions and observations from the facts and arguments on which the Office bases its decision.

### 3 Procedural Aspects

[Article 104\(2\) EUTMR](#)

[Article 65\(1\)\(i\) EUTMDR](#)

Article 67(2) CDR

Article 68(1)(g) CDIR

#### 3.1 Proceedings to which *restitutio in integrum* applies

*Restitutio in integrum* is available in all proceedings before the Office (*ex parte*, *inter partes* and appeal proceedings).

This includes proceedings under the EUTMR and proceedings concerning registered Community designs under the CDR. The relevant provisions do not differ materially, however the requirements for translations differ (see [paragraph 3.8](#)).

Therefore, unless specifically excluded by [Article 104\(5\) EUTMR](#) or Article 67(5) CDR, *restitutio in integrum* is available.

The reference to [Article 105 EUTMR](#) in [Article 104\(5\) EUTMR](#) should be understood as only excluding from *restitutio in integrum* the time limits which are laid down as such in [Article 105 EUTMR](#), namely the time limits for requesting continuation of proceedings and paying the fee pursuant to [Article 105\(1\) EUTMR](#). Consequently, *restitutio in integrum* is available for the time limits mentioned in [Article 105\(2\) EUTMR](#) to the extent that they are not expressly excluded by [Article 104\(5\) EUTMR](#).

Unlike the EUTMR for EUTMs, the CDR does not provide for continuation of proceedings for RCDs.

For *restitutio* in renewal proceedings see [paragraph 3.13](#).

#### 3.2 Parties

[Article 104 EUTMR](#)

Article 67 CDR

*Restitutio in integrum* is available to any party to proceedings before the Office.

The time limit must have been missed by the party concerned or its representative.

### 3.3 Time limit for national offices to forward an application to the Office

Articles 35(1) and 38(2) CDR

The time limit of 2 months for transmission of a Community design application filed at a national office has to be observed by the national office and not by the applicant and is consequently not open to *restitutio in integrum*.

Under Article 38(2) CDR, late transmission of a Community design application has the effect of postponing the date of filing to the date the Office actually receives the relevant documents.

### 3.4 Time limits excluded from *restitutio in integrum*

[Article 104\(5\) EUTMR](#)

Article 67(5) CDR

In the interests of legal certainty, *restitutio in integrum* is not applicable to the following time limits.

Articles 41(1) and 67(5) CDR

Article 8(1) CDIR

- The priority period, which is the 6-month time limit for filing an application claiming the priority of a previous design or utility model application pursuant to Article 41(1) CDR. However, *restitutio in integrum* does apply to the 3-month time limit for providing the file number of the previous application and filing a copy of it, as specified in Article 8(1) CDIR.

Articles [46\(1\) and \(3\)](#) and [104\(5\)](#) EUTMR

- The time limit for filing an opposition pursuant to [Article 46\(1\) EUTMR](#), including the time limit for paying the opposition fee referred to in [Article 46\(3\) EUTMR](#).

[Article 104\(2\) and \(5\) EUTMR](#)

Article 67(2) and (5) CDR

- The time limits for *restitutio in integrum* itself, namely:
  - a time limit of 2 months for filing the application for *restitutio in integrum* as from the removal of the cause of non-compliance;
  - a time limit of 2 months from the date for completing the act that was omitted;

- a time limit of 1 year for filing the application for *restitutio in integrum* as from the expiry of the missed time limit.

[Article 105\(1\) EUTMR](#)

- The time limit for requesting continuation of proceedings pursuant to [Article 105 EUTMR](#), including the time limit for paying the fee referred to in [Article 105\(1\) EUTMR](#).

[Article 72\(5\) EUTMR](#)

- The 2-month time limit to file an appeal against the decision of the Boards of Appeal before the General Court (08/06/2016, [T-583/15](#), DEVICE OF THE PEACE SYMBOL, EU:T:2016:338).

### 3.5 Effect of *restitutio in integrum*

Granting *restitutio in integrum* has the retroactive legal effect that the time limit that was not met will be considered to have been met, and that any loss of rights in the interim will be deemed never to have occurred. If the Office has taken a decision in the interim based on failure to meet the time limit, that decision will become void, with the consequence that, once *restitutio in integrum* is granted, there is no longer any need to lodge an appeal against such a decision of the Office in order to have it removed. Effectively, *restitutio in integrum* will re-establish all the rights of the party concerned.

### 3.6 Time limits

Articles [53\(3\)](#) and [104\(2\)](#) EUTMR

Articles 13(3) and 67(2) CDR

Applicants must apply to the Office in writing for *restitutio in integrum*.

The applicant must make the application within 2 months of the removal of the cause of non-compliance and no later than 1 year after expiry of the missed time limit. Within the same period, the act that was omitted must be completed. The date when the cause of non-compliance is removed is the first date on which the party knew or should have known about the facts that led to the non-observance. If the ground for non-compliance was the absence or illness of the professional representative dealing with the case, the date on which the cause of non-compliance is removed is the date on which the representative returns to work.

If the application for *restitutio in integrum* is filed late, it will be rejected as inadmissible.

### 3.7 Fees

[Article 104\(3\)](#) and [Annex I \(22\) EUTMR](#)

Article 67(3) CDR

Annex, point 15 CDFR

The applicant must also pay the fee for *restitutio in integrum* within the same time limit (see [paragraph 3.6](#) above).

As a general rule, the individual fee (EUR 200) must be paid for each application for *restitutio in integrum* (i.e. one fee is due per individual right). Nevertheless, in certain cases exceptions may apply. The minimum conditions for applying such exceptions are the following:

1. all the rights should relate to the same rights holder;
2. all the rights should be of the same type (e.g. EUTMs, RCDs);
3. the unobserved time limit should be the same for all rights (e.g. missed time limit for renewal);
4. the loss of all rights concerned should be the result of the same circumstances.

These conditions are cumulative. Therefore, only when all of them are met, can the application for *restitutio in integrum* relating to multiple rights be subject to a single fee.

If all the conditions are not met, an individual fee must be paid for each right concerned.

If the applicant does not pay the fee by expiry of the time limit, the application for *restitutio in integrum* will be deemed not to have been filed.

In the event the application is deemed not to have been filed due to late or insufficient payment of the fee or because it was filed in relation to a time limit that is excluded from *restitutio in integrum* (see [paragraph 3.4](#) above), any fee paid (including late or insufficient fees) will be refunded.

However, once the application for *restitutio in integrum* has been deemed to have been filed, the fee will not be refunded if the request for *restitutio in integrum* is later withdrawn, rejected as inadmissible or rejected on the grounds of the substance of the claim (i.e. if the 'all due care' requirement is not fulfilled, see [paragraph 2.1](#) above).

### 3.8 Languages and translations

[Article 146 EUTMR](#)

[Article 24 EUTMIR](#)

Article 98 CDR

Article 80 and 81 CDIR

The applicant must submit the application for *restitutio in integrum* in the language, or in one of the languages, of the proceedings in which the failure to meet the time limit occurred. For example, in the EUTM registration procedure, this is the correspondence language indicated in the application; in the RCD registration procedure this is the language used for filing the application or the second language indicated by the applicant in the application; in the opposition procedure, it is the language of the opposition procedure; in the RCD invalidity procedure, it is the language of the invalidity procedure (Article 98(4) CDR); and in the renewal procedure, it is any of the Office's five languages.

Where the application for *restitutio in integrum* is not filed in the language of the proceedings, the applicant must submit a translation into that language within one month of the date of submission of the application ([Article 146\(9\) EUTMR](#) and Article 81(1) CDIR). If a translation into the language of proceedings is not submitted on time, the application for *restitutio in integrum* will be rejected as inadmissible.

Evidence in support of the application for *restitutio in integrum* may be filed in any official language of the European Union. The rules for translation in EUTM proceedings differ from those in RCD proceedings. Where evidence in EUTM proceedings was not submitted in the language of the proceedings, the Office may require a translation into that language ([Article 24 EUTMIR](#)). In proceedings concerning RCDs, the Office may require that a translation be supplied, within a time limit specified by it, in the language of the proceedings or, at the choice of the party to the proceedings, in any language of the Office (Article 81(2) CDIR).

If a translation is not submitted on time, the evidence will be disregarded.

### 3.9 Particulars and evidence

Articles [97](#) and [104](#) EUTMR

Articles 65 and 67 CDR

In its application for *restitutio in integrum* the applicant must state the grounds on which the application is based and set out the facts on which it relies. The application must set out which deadline has been missed.

As granting *restitutio in integrum* is essentially based on facts, it is advisable for the requesting party to submit evidence by means of sworn or affirmed statements. Statements drawn up by the interested parties themselves or their employees are generally given less weight than independent evidence (16/06/2015, [T-586/13](#), Gauff THE ENGINEERS WITH THE BROADER VIEW (fig.) / Gauff et al., EU:T:2015:385, § 29).

Moreover, the act that was omitted must be completed, together with the application for *restitutio in integrum*, at the latest by the time limit for submitting that application. For example, if the deadline to submit observations has been missed, the observations must be submitted with the request for *restitutio in integrum*. A request for extension of the time limit will not be accepted as the 'omitted act'. If the payment of a fee has been missed, that fee must be paid together with the *restitutio in integrum* request.

If the grounds on which the application is based, and the facts on which it relies are not submitted, the application for *restitutio in integrum* will be rejected as inadmissible. The same applies if the omitted act is not completed.

### 3.10 Competence

[Article 104 EUTMR](#)

Article 67 CDR

The division or department competent to decide on the act that was omitted (i.e. responsible for the procedure in which failure to meet the deadline occurred) is responsible for dealing with applications for *restitutio in integrum*.

### 3.11 Publications

Articles [53\(5\)](#), [\(7\)](#) and [\(8\)](#), and [104\(7\)](#), Articles [111\(3\)\(k\)](#) and [\(l\)](#) and [116\(1\)\(a\)](#) EUTMR

Article 67 CDR

Article 22(4) and (5), Article 69(3)(m) and (n) and Article 70(2) CDIR

The EUTMR and CDR provide for a mention of the re-establishment of rights to be published in the Bulletin. This mention will be published only if the failure to meet the time limit that gave rise to the application for *restitutio in integrum* has actually led to publication of a change of status of the EUTM or RCD application or registration, because only in such a case would third parties be able to take advantage of the absence of such rights. For example, the Office will publish a mention that *restitutio in integrum* has been granted if it published a mention that registration had expired due to failure to meet the time limit for paying the renewal fee.

In the event of such a publication, a corresponding entry will also be made in the Register.

No mention of receipt of an application for *restitutio in integrum* will be published.

### **3.12 Decision, role of other parties in *restitutio in integrum* proceedings**

Articles [66](#) and [67](#) EUTMR

The applicant for *restitutio in integrum* is the sole party to the *restitutio in integrum* proceedings, even where failure to meet the time limit occurred in *inter partes* proceedings.

The decision on *restitutio in integrum* will be taken, if possible, in the decision terminating the proceedings. The Office may also adopt a separate decision on the application for *restitutio in integrum*. In both cases, the applicant for *restitutio in integrum* can appeal the refusal of its request for *restitutio in integrum* together with an appeal against the decision terminating the proceedings.

The decision to grant *restitutio in integrum* cannot be appealed.

The other party to *inter partes* proceedings will be informed both that *restitutio in integrum* has been requested and about the outcome of the proceedings. If *restitutio in integrum* is granted, the other party's only means of redress is to initiate third-party proceedings (see [paragraph 4](#) below).

### **3.13 *Restitutio in integrum* in the event of renewals**

The principles mentioned in this chapter also apply to requests for *restitutio in integrum* in renewal proceedings, but with the following particularities.

#### **Party to the proceedings**

In renewal proceedings, authorised persons within the meaning of [Article 53\(1\) EUTMR](#) or Article 13(1) CDR who missed the renewal deadline are party to the renewal proceedings and may, therefore, request *restitutio in integrum* in their own name (23/09/2020, [T-557/19](#), 7SEVEN (fig.), EU:T:2020:450, § 26, 31-32).

#### **Time limits**

Where a renewal deadline was missed and the loss of rights was notified to the EUTM proprietor, the day of this notification is the point in time from which a diligent proprietor has 2 months to comply with the requirements set out in [Article 104 EUTMR](#) or Article 67 CDR (30/09/2010, [C-479/09 P](#), DANELECTRO, EU:C:2010:571, § 36, 42; 28/09/2021, [R 396/2021-2](#), Netcomponents, § 28). The notification of the loss of right to the proprietor is also valid for an authorised person (23/09/2020, [T-557/19](#), 7SEVEN (fig.), EU:T:2020:450, § 47 et seq.).

If the applicant fails to submit the request for renewal or to pay the renewal fee, the 1-year period after expiry of the missed time limit ([Article 104\(2\) EUTMR](#) or Article 67(2) CDR) starts on the day on which the protection ends, and not on the date the further 6-month time limit set out by [Article 53\(3\) EUTMR](#) or Article 13(3) CDR expires.

### **Fees**

The exception to the general rule that an individual fee must be paid for each application for *restitutio in integrum* also applies to renewals (see [paragraph 3.7](#)). When a party has missed renewing multiple EUTM registrations, it can file a single request for *restitutio in integrum* for the renewal of all of its marks and pay a single *restitutio in integrum* fee.

The fees must be paid together with the *restitutio in integrum* request. The fee amount depends on which time limit the party asks to have reinstated: the basic period for renewal, the grace period for renewal or the deadline for late payment within the meaning of [Article 180 EUTMR](#) or Article 7(3) CDFR.

### **Indication of which period should be reinstated**

In its application for *restitutio in integrum*, the applicant must clearly state if it is seeking reinstatement of the basic period, the grace period or the period within the meaning of [Article 180 EUTMR](#) or Article 7(3) CDFR.

## **4 Third-Party Proceedings**

[Article 104\(6\) and \(7\) EUTMR](#)

Article 67 CDR

A third party who, in the period between the loss of rights and publication of the mention of the re-establishment of rights,

- has, in good faith, put goods on the market or supplied services under a sign that is identical or similar to the EUTM, or
- in the case of a Community design, has, in good faith, put on the market products in which a design included within the scope of protection of the RCD is incorporated or to which it is applied,

may bring third-party proceedings against the decision re-establishing the rights of the applicant, proprietor or holder of the EUTM or RCD.

This request is subject to a 2-month time limit, which starts:

- on the date of publication, where publication has taken place;
- on the date on which the decision to grant *restitutio in integrum* took effect, where publication has not taken place.

The Regulations do not contain any provisions governing this procedure. The division or department that took the decision to re-establish the rights is responsible for third-



party proceedings. The Office will conduct adversarial *inter partes* proceedings, which means that it will hear both parties before taking a decision.

***GUIDELINES FOR EXAMINATION OF  
EUROPEAN UNION TRADE MARKS***

***EUROPEAN UNION  
INTELLECTUAL PROPERTY OFFICE  
(EUIPO)***

***Part A***

***General rules***

***Section 9***

***Enlargement***

## Table of Contents

<b>1 Introduction.....</b>	<b>173</b>
<b>2 Rules Concerning Examination.....</b>	<b>173</b>
<b>2.1 Automatic extension of EUTMs to new Member States.....</b>	<b>173</b>
<b>2.2 Pending EUTM applications.....</b>	<b>173</b>
<b>2.3 Distinctiveness acquired through use.....</b>	<b>174</b>
<b>2.4 Bad faith.....</b>	<b>174</b>
<b>2.5 Conversion.....</b>	<b>175</b>
<b>2.6 Other practical consequences.....</b>	<b>175</b>
2.6.1 Professional representation.....	175
2.6.2 First and second language.....	176
2.6.3 Translation.....	176
2.6.4 Seniority.....	176
2.6.5 Search.....	176
<b>3 Rules Concerning Oppositions and Cancellations.....</b>	<b>176</b>
<b>Annex 1.....</b>	<b>180</b>

## 1 Introduction

This section discusses the rules relating to the accession of new Member States to the European Union and the consequences for holders of European Union trade marks. Both absolute and relative grounds are dealt with in this section.

[Article 209 EUTMR](#) contains the relevant provisions relating to enlargement and European Union trade marks. These provisions were introduced into the Regulation pursuant to the 2004 enlargement process (at that time [Article 142a CTMR](#)) and have remained unchanged during successive enlargement processes. The only modification in the text of the Regulation is the addition of the names of the new Member States.

A table in [Annex 1](#) lists the new Member States with their accession dates and official languages.

## 2 Rules Concerning Examination

### 2.1 Automatic extension of EUTMs to new Member States

[Article 209\(1\) EUTMR](#) lays down the basic rule of enlargement, which is that all existing EUTM applications and registered EUTMs are automatically extended to the new Member States without any kind of additional intervention by the European Union Intellectual Property Office, any other body or the holders of the rights concerned. There is no need to pay any extra fees or complete any other administrative formality. The extension of existing EUTM applications or EUTMs to the territories of new Member States ensures that these rights have equal effect throughout the EU and complies with the fundamental principle of the unitary character of the EUTM.

### 2.2 Pending EUTM applications

[Article 209\(2\) EUTMR](#) enshrines an important transitional provision, according to which EUTM applications **pending on the accession date** may not be refused on the basis of any absolute ground for refusal if this ground becomes applicable merely because of the accession of a new Member State ('grandfathering clause'). In practice, this means that if an EUTM application is non-distinctive, descriptive, generic, deceptive or contrary to public policy or morality in the language or in the territory of a new Member State, it will not be refused if its filing date is **before** this State's accession date.

For applications filed **after the accession date** the grounds for refusal of [Article 7\(1\) EUTMR](#) apply also for the new Member State. This is the case even when the EUTM application has a priority date that is earlier than the relevant accession date. The priority right does not protect the EUTM applicant against any change in the law relevant to its application. Therefore, examiners have to apply the same examination

criteria as for all the other official languages of the EU. This means that the examiner also has to check whether the EUTM application is descriptive, etc. in the new Member State.

However, this principle should be applied with caution as it merely means that the criteria for applying [Article 7\(1\) EUTMR](#) should not be made stricter as a result of the accession of new Member States. The inverse conclusion that terms that are descriptive in a language or in the territory of a new Member State may, in any event, be registered for EUTM applications filed prior to the accession date will not always be correct. For example, descriptive terms from new Member States' languages may have entered the customary languages of existing Member States or be widely known in them (e.g. vodka), and geographical indications may already have to be refused as descriptive terms (e.g. Balaton or Tokaj). Consideration must also be given to geographical indications already protected in the new Member States and to protection arising from EU legislation or bilateral treaties between the new Member States and the EU or existing Member States.

More precisely, the grounds for refusal of [Article 7\(1\)\(f\) and \(g\) EUTMR](#), relating to marks contrary to public policy or morality and deceptive marks respectively, are only affected by this provision insofar as the deceptiveness or breach of public morality is due to a meaning that is **only** understood in a language of a new Member State. The Office interprets [Article 7\(1\)\(f\) EUTMR](#) in accordance with EU-wide criteria, irrespective of the relative levels of morality in different countries of the EU.

Finally, the provision of [Article 209\(2\) EUTMR](#) does not affect the grounds for refusal of [Article 7\(1\)\(e\) or \(i\) EUTMR](#): the former relates to signs consisting exclusively of the shape, or another characteristic, which results from the nature of the goods themselves, the shape, or another characteristic, which is necessary to obtain a technical result or the shape, or another characteristic, which gives substantial value to the goods, and the latter relates to badges and emblems not protected by [Article 6ter of the Paris Convention](#) but of particular public interest.

## 2.3 Distinctiveness acquired through use

According to Office practice, distinctiveness acquired through use ([Article 7\(3\) EUTMR](#)) must exist on the EUTM filing date and subsist until its registration date. Where an applicant for an EUTM application filed **before** the accession date is able to demonstrate that acquired distinctiveness existed at the filing date, [Article 209\(2\) EUTMR](#) precludes an objection based on the ground that it is not distinctive through use in the new Member States. Therefore, the applicant does not have to prove acquired distinctiveness in the new Member States.

## 2.4 Bad faith

The Office will consider the filing of an EUTM application as having been made in bad faith if it was made prior to the accession date for a term that is descriptive or otherwise

not eligible for registration in the language of a new Member State for the sole purpose of obtaining exclusive rights to a non-registrable term or for otherwise objectionable purposes.

This has no practical effect during the examination stage, as bad faith does not constitute an absolute ground for refusal and, consequently, the Office has no authority to object *ex officio*. The Office will exercise its duties in respect of 'bad faith filings' only when a request for a declaration of invalidity is filed ([Article 59\(1\)\(b\) EUTMR](#)). The national offices of the new Member States are equally determined to act against bad faith in the context of enlargement. EUTM applicants should, therefore, bear in mind that, even if there are no grounds for refusal during the registration procedure, their EUTM registrations may be contested at a later date on the basis of [Article 59\(1\)\(b\) EUTMR](#).

## 2.5 Conversion

Conversion of an EUTM application into national trade mark applications for new Member States may be requested as from the accession date of those States. Conversion is also possible when a converted EUTM has a filing date prior to the accession date. However, in the case of a new Member State, the converted application will have the effect of an earlier right under national law. National law in new Member States has enacted provisions equivalent to [Article 209 EUTMR](#) providing that extended EUTMs have the effect of earlier rights in the new Member States only with effect from the accession date. In practice, this means that the 'conversion date' in a new Member State cannot be earlier than that State's accession date.

Taking Croatia's accession as an example, this means that even if a converted EUTM has a filing date of 01/05/2005, in Croatia the conversion date will not be 01/05/2005 but 01/07/2013, that is to say, Croatia's accession date.

The date of enlargement does not trigger a new 3-month time limit for requesting conversion under [Article 139\(4\) EUTMR](#).

## 2.6 Other practical consequences

### 2.6.1 Professional representation

As from the accession date of a new Member State, applicants (as well as other parties to proceedings before the Office) with their seat or domicile in that State need no longer be represented by a professional representative. As from the accession date of a new Member State, professional representatives from that State may be entered on the list of professional representatives maintained by the Office pursuant to [Article 120 EUTMR](#) and may then represent third parties before the Office.

## 2.6.2 First and second language

As of the accession date of a new Member State (see [Annex 1](#)), the official language(s) of that State may be used as the first language for EUTM applications filed on or after that date.

## 2.6.3 Translation

EUTM applications with a filing date prior to the accession date of a new Member State and existing EUTM registrations will neither be translated into nor republished in the language of that State. EUTM applications filed after the accession date of a new Member State will be translated into and published in all official languages of the EU.

## 2.6.4 Seniority

Seniority may be claimed from a national trade mark that was registered before the accession of the new Member State in question or even before the creation of the European Union. The seniority claim may, however, only be made after the accession date. The mark registered in the new Member State must be 'earlier' than the EUTM. As an extended EUTM has, in the new Member State, the effect of an earlier right as from the accession date, the seniority claim only makes sense when the earlier national mark has a filing or priority date prior to the accession date.

- **Example 1:** The same person files an EUTM application on 01/04/1996 and a national trade mark application in Romania on 01/01/1999. After 01/01/2007 (Romania's date of accession), the seniority of the Romanian national trade mark application may be claimed.
- **Example 2:** The same person owns an international registration designating the EU on 01/01/2005 and subsequently designating Romania on 01/01/2006. After 01/01/2007, the seniority of that Romanian designation may be claimed even though the designation itself is later than the IR designating the EU. This is because the extended EUTM takes effect from the accession date of the new Member State (in this case 01/01/2007).

## 2.6.5 Search

The national offices of a new Member State may carry out searches ([Article 43\(2\) and \(3\) EUTMR](#)) as from that State's accession date. Only EUTM applications with a filing date on or after the accession date are sent to national offices for a search.

# 3 Rules Concerning Oppositions and Cancellations

1. According to [Article 209\(4\)\(b\) EUTMR](#), an EUTM application cannot be opposed or declared invalid on the basis of a national earlier right acquired in a new Member State prior to that State's accession date.

However, EUTM applications filed on or after the accession date are not subject to this 'grandfathering clause' and may be rejected upon opposition, or declared invalid, on account of an earlier national right existing in a new Member State, provided that the earlier right is 'earlier' when the two filing or priority dates are compared.

2. An exception to this (transitional) rule is contained in [Article 209\(3\) EUTMR](#) regarding oppositions. An EUTM application filed within the 6 months preceding the accession date may be challenged by an opposition based on a national right existing in a new Member State at the date of the accession, provided that this right
  - a. has an earlier filing or priority date, and
  - b. was acquired in good faith.
3. The filing date and not the priority date is the decisive element for determining when an EUTM application can be opposed on the basis of an earlier right in a new Member State. In practice, the abovementioned provisions have the consequences illustrated in the following examples with reference to the accession of Croatia (01/07/2013).
  - a. An EUTM application filed before 01/01/2013 (the priority date is irrelevant in this context) cannot be opposed or declared invalid on the basis of a national earlier right in a new Member State under any circumstances.
  - b. An EUTM application with a filing date between 01/01/2013 and 30/06/2013 (i.e. **during the 6 months prior to the date of accession** ), may be opposed by a Croatian trade mark, provided that the filing or priority date of the Croatian trade mark is earlier than the filing or priority date of the opposed EUTM application and the national mark was applied for in good faith.
  - c. An EUTM application with a filing date of 01/07/2013 or later may be opposed or declared invalid on the basis of a trade mark registered in Croatia if that mark has an earlier filing or priority date under the normal rules. Acquisition in good faith is not a condition. This applies to all national marks and earlier non-registered rights filed or acquired in a new Member State prior to accession.
  - d. An EUTM application with a filing date of 01/07/2013 or later but with a priority date before 01/07/2013 may be opposed or declared invalid on the basis of a national trade mark registered in Croatia if that mark has an earlier filing or priority date under the normal rules.

This transitional exception is limited to the right to file an opposition and does not include the right to file an application for cancellation based on relative grounds. This means that once the abovementioned period of 6 months has expired without an opposition having been lodged, the EUTM application cannot be challenged any more by an opposition or by an application for a declaration of invalidity.

4. According to [Article 209\(5\) EUTMR](#) , the use of an EUTM with a filing date prior to the date of accession of a new Member State, may be prohibited pursuant to Articles [137](#) and [138](#) EUTMR on the basis of an earlier national trade mark registered in the new Member State where the latter has a filing or priority date prior to the date of accession and was registered in good faith.

The above provision also applies to:



- applications for national marks filed in new Member States, provided that they have subsequently been registered;
  - unregistered rights acquired in new Member States falling under [Article 8\(4\)](#) or [Article 60\(2\) EUTMR](#) with the proviso that the date of acquisition of the right under national law replaces the filing or priority date.
5. Where an opposition is based on a national registered mark or other right in a new Member State, whether or not that right may validly be invoked as a ground for opposition against an EUTM application depends on whether the opposition is well founded and is not an issue of admissibility.
6. The acquisition in good faith of the earlier national mark is presumed. This means that, if good faith is questioned, the other party to the proceedings (the applicant for the opposed EUTM application in the case of [Article 209\(4\) EUTMR](#) or the owner of the registered EUTM in the case of [Article 209\(5\) EUTMR](#) ) must prove that the owner of the earlier national right obtained in a new Member State acted in bad faith when filing the national application or otherwise acquiring the right.
7. [Article 209 EUTMR](#) does not contain any transitional provisions concerning the use requirement (Articles [18](#) and [47](#) EUTMR). In opposition proceedings, the obligation to prove genuine use of the mark arises when the applicant for the opposed EUTM application requests that the opponent prove use of the earlier mark pursuant to [Article 47\(2\) and \(3\) EUTMR](#) and [Article 10 EUTMDR](#) . Issues relating to enlargement could arise regarding the time and place of use of the earlier mark. Two cases can be distinguished.

**a. The earlier mark is a national mark registered in a new Member State**

In this case, the opponent must prove genuine use of the earlier mark. This situation can only arise in the context of an opposition directed either against an EUTM application with a filing date after the date of accession or against an EUTM application filed within the period of 6 months preceding the date of accession.

The earlier national mark must have been put to genuine use in the territory in which it is protected during the 5 years preceding the filing or priority date<sup>2</sup> of the contested EUTM application. In this regard, it is immaterial whether the use relates to a period during which the State concerned was already a Member State of the European Union. In other words, the proof of use may also relate to a period prior to the date of accession (in the case of Croatia before 01/07/2013).

**b. The earlier mark is an EUTM**

Where the owner of the earlier EUTM can prove use only in the territory of a new Member State or several new Member States, since the obligation of use relates to the period of 5 years preceding the filing or priority date<sup>3</sup> of the contested EUTM application, use in a new Member State (or several new Member States) can only be taken into account if the State concerned was a Member State of the European Union at the date of filing or the priority date of of the contested EUTM application ( [Article 47\(2\) EUTMR](#) requires use '*in the Union*'). Before their

---

<sup>2</sup> For oppositions and invalidity applications filed before 23/03/2016, the relevant date is the publication date.

<sup>3</sup> For oppositions and invalidity applications filed before 23/03/2016, the relevant date is the publication date.

accession dates, the new States do not constitute 'Member States of the Union'; therefore, it is not possible to prove use *'in the Union'*.

Therefore, the 5-year period should be counted only from the relevant date of accession.

8. There are no particular transitional problems relating to the opposition proceedings. The right pursuant to [Article 146\(8\) EUTMR](#) to choose a language that is not one of the five languages of the Office as the language of the proceedings applies as from the date of accession in respect of the other official languages of the European Union.

**Annex 1**

<b>Member States</b>	<b>Accession date</b>	<b>Languages</b>
Czech Republic, Estonia, Cyprus, Latvia, Lithuania, Hungary, Malta, Poland, Slovenia and Slovakia.	01/05/2004	Czech, Estonian, Greek, Latvian, Lithuanian, Hungarian, Maltese, Polish, Slovak and Slovenian
Bulgaria and Romania	01/01/2007	Bulgarian and Romanian
Croatia	01/07/2013	Croatian

---

**GUIDELINES FOR EXAMINATION**

**EUROPEAN UNION**  
**INTELLECTUAL PROPERTY OFFICE**  
**(EUIPO)**

***Part B***

***Examination***

---

## Table of Contents

<b>Section 1 Proceedings.....</b>	<b>183</b>
<b>Section 2 Formalities.....</b>	<b>199</b>
<b>Section 3 Classification.....</b>	<b>279</b>
<b>Section 4 Absolute grounds for refusal.....</b>	<b>343</b>

***GUIDELINES FOR EXAMINATION OF  
EUROPEAN UNION TRADE MARKS***

***EUROPEAN UNION  
INTELLECTUAL PROPERTY OFFICE  
(EUIPO)***

***Part B***

***Examination***

***Section 1***

***Proceedings***

## Table of Contents

<b>1 Introduction and General Overview of Examination Proceedings.....</b>	<b>185</b>
<b>2 Searches.....</b>	<b>186</b>
<b>2.1 European Union search reports.....</b>	<b>186</b>
<b>2.2 National search reports.....</b>	<b>187</b>
<b>3 General Principles Concerning Examination Proceedings.....</b>	<b>187</b>
<b>3.1 Procedural aspects concerning third-party observations and review     of absolute grounds.....</b>	<b>188</b>
<b>3.2 Decisions.....</b>	<b>189</b>
3.2.1 Appeals.....	189
<b>3.3 International registrations designating the European Union.....</b>	<b>189</b>
<b>4 Publication.....</b>	<b>189</b>
<b>5 Amendments to an EUTM Application.....</b>	<b>190</b>
<b>5.1 Withdrawal of an EUTM application.....</b>	<b>191</b>
5.1.1 Declaration of withdrawal.....	191
5.1.2 Unconditional and binding character of the declaration.....	192
5.1.3 Action to be taken.....	192
<b>5.2 Restriction of the list of goods and services in an EUTM application.....</b>	<b>193</b>
5.2.1 Procedural admissibility of a restriction.....	193
<b>5.3 Other amendments.....</b>	<b>194</b>
5.3.1 Name and address of applicant or representative.....	195
5.3.2 Recording and publication of amendments.....	195
<b>5.4 Division of an EUTM application.....</b>	<b>195</b>
5.4.1 Requirements.....	196
5.4.2 Acceptance.....	197
5.4.3 New files and their publication.....	197

## 1 Introduction and General Overview of Examination Proceedings

This part of the Guidelines outlines the examination procedure from filing to publication of the European Union trade mark (EUTM) application.

Once the EUTM application has been filed, a provisional filing date is accorded, and the Office issues a receipt. At this early stage, the Office only checks whether certain filing date requirements of the European Union trade mark regulation (EUTMR) have been fulfilled. The filing date will only become definitive when the application fee has been paid.

The applicant should check the receipt carefully and notify the Office of any incorrect data. The applicant can only correct data that have an impact on the filing date, such as the applicant's name, the representation of the mark and the list of goods and services, if it notifies the Office on the same date as the incorrect data were submitted. After this date, any amendment is subject to the provisions of the EUTMR, Implementing Regulation (EUTMIR) and Delegated Regulation (EUTMDR), in particular, Articles [20](#) and [49](#) EUTMR. For further details, see [paragraph 5](#) and the Guidelines, [Part B, Examination, Section 2, Formalities](#).

After the receipt has been issued, the Office carries out a language check of the verbal elements of the mark in all the official languages of the EU and prepares a European Union search report. This report will be sent to the applicant only if it was expressly requested when the application was filed.

Payment of the application fee and national search fee (if applicable) is validated 1 month at the latest after the EUTM application has been filed. If the applicant has applied for a national search and paid the relevant fee, the Office forwards the application to the offices of the Member States that perform national searches. For further information on searches, see [paragraph 2](#). For further information on fees, see the Guidelines, [Part A, General Rules, Section 3, Payment of Fees, Costs and Charges](#).

During the examination proceedings, the Office examines the following: filing date, formalities, classification, priority and/or seniority where applicable, the regulations governing use of the mark for collective and certification marks, and absolute grounds for refusal. All these examination steps can be carried out in parallel as there is no strict sequence in examination proceedings.

The applicant will be notified of any deficiency and given 2 months to remedy it and/or submit observations. Any decision partially or wholly refusing an EUTM application must give the ground(s) on which the EUTM application has been refused and inform the applicant of the right to appeal. For further details, see [paragraph 3.2](#) and [paragraph 3.2.1](#).

Applications that comply with the requirements of the regulation are accepted for publication and sent for translation into all the official languages of the EU.



The last step in the examination procedure is the publication of the application in Part A of the European Union Trade Marks Bulletin (EUTM Bulletin). For further details on publication, see [paragraph 4](#).

## 2 Searches

Articles [43](#) and [195](#) EUTMR

The search report identifies earlier rights that could conflict with the EUTM application. However, even if the search report does not indicate any similar earlier rights, an opposition could still be filed against the EUTM application after its publication.

The results of the search report are for information purposes only and to give the applicant the option of withdrawing the EUTM application before it is published. Surveillance letters inform holders of earlier EUTMs about similar new EUTM applications.

Figurative elements are classified under the Vienna Classification.

### 2.1 European Union search reports

The Office will prepare a European Union search report (EU search report) for each EUTM application or international registration (IR) designating the EU that it receives.

However, it will only send the EU search report to the EUTM applicant when the applicant has expressly requested this at the time of filing the application.

Holders of IRs designating the EU that wish to receive an EU search report must send the request to the Office within 1 month of the date of notification of the IR by the World Intellectual Property Organization (WIPO).

The EU search report covers the following earlier rights:

1. EUTM applications with a filing date or priority date earlier than that of the application in question;
2. EUTM marks already registered; and
3. prior international registrations (IR) designating the EU.

The EU search report takes into account the filing date, the verbal elements of the trade mark, the figurative elements of the mark (if applicable) and the classes of goods and services according to the Nice Classification. The search is designed to identify similar earlier marks filed for the same classes or for classes that are considered to contain similar goods and/or services by the Office.

Once the new application has been published, the Office will send a surveillance letter to the proprietors of any earlier EUTMs, EUTM applications or international registrations designating the EU cited in the EU search report, unless the proprietors have expressly requested not to receive these notifications. Such a request can be

made at any time in writing, specifying the EUTM in relation to which the proprietor does not wish to receive surveillance letters.

The sole purpose of the search is to inform the applicant for an EU trade mark, in a non-exhaustive manner, whether there are any conflicts with regard to relative grounds for refusal. They are not intended to produce information useful to the examination of absolute grounds for refusal (07/06/2001, [T-359/99](#), EuroHealth, EU:T:2001:151, § 31). The Office's search report cites only those trade marks that have been discovered and may potentially be invoked under [Article 8 EUTMR](#). It does not preclude other trade marks that have not been discovered and not listed from being invoked in opposition proceedings (11/12/2014, [R 1160/2014-1](#), VALUA (fig. mark) / VALEA et al, § 37).

## 2.2 National search reports

At the time of filing an application, an EUTM applicant may also request national search reports. These reports list any earlier national trade marks, national trade mark applications or trade marks registered under international agreements having effect in the Member State(s) concerned that have been discovered and that may be invoked under [Article 8 EUTMR](#) against the registration of the EUTM applied for, or state that the search has revealed no such rights. These reports are subject to the payment of the corresponding search fees.

Holders of IRs designating the EU that wish to apply for national searches must send the request and pay the relevant fee to the Office within 1 month of the date of notification of the IR by WIPO.

EUTM applications and IR designations that include a valid request for national searches are sent to the participating national offices. A request is valid if it is made at the time of filing and the relevant fee has been paid.

National search reports are prepared by offices that participate in the search system. For more details concerning the participating countries, see the [Office's website](#).<sup>(4)</sup>

A request for national searches implies that all participating national offices will carry out the search. This all-or-nothing approach means that the applicant cannot select the particular participating offices that it wishes to carry out the search.

The national offices are responsible for the content of the national search report.

## 3 General Principles Concerning Examination Proceedings

This section describes only the **procedural** aspects of examining absolute grounds (AG) for refusal. For substantive aspects of examining absolute grounds for refusal, see [the Guidelines, Part B, Examination, Section 4, Absolute Grounds for Refusal](#).

---

<sup>4</sup> <https://euipo.europa.eu/ohimportal/en/faq-search-availability>

The EUTMR is intended to enable proprietors to register a right that is valid throughout the European Union provided it does not impinge on the rights of others. Although rights can only be conferred in accordance with the provisions of the EUTMR, the Office's function is to facilitate applications, not obstruct them.

During the examination of each application, the trade mark **and** the goods or services of the application must be taken into account. The Office bears in mind the nature of the trade mark concerned, the manner in which the goods or services are provided and the relevant public — for example, whether it consists of specialists or the general public.

### **3.1 Procedural aspects concerning third-party observations and review of absolute grounds**

#### [Article 45 EUTMR](#)

Communication No [2/09](#) of the Executive Director of the Office

Observations on the existence of an absolute ground for refusal can be made by third parties. Third-party observations received before an EUTM application has been published are dealt with during the examination of absolute grounds for refusal. The Office accepts observations received within the opposition period (3 months from the date of publication) or submitted — in cases where an opposition has been filed — before the final decision on the opposition has been taken. The observations must be submitted in one of the Office's languages: English, French, German, Italian or Spanish.

The Office issues a receipt to the party that submitted the observations (the observer), confirming that the observations have been received and have been forwarded to the applicant. The observer does not become a party to the proceedings before the Office but can consult the online search tools to check the status of the relevant EUTM application. The Office does not inform the observer of any action taken, or whether or not the observations have given rise to an objection.

All observations are forwarded to the applicant, who is invited to submit comments, where appropriate. The Office considers whether the observations are well founded, that is to say, whether an absolute ground for refusal exists. If so, the Office issues an objection and may refuse the EUTM application if the objection is not overcome by the applicant's comments or by a restriction of the list of goods and services.

The Office may also reopen the examination of absolute grounds on any other ground and at any time prior to registration — for example, when third-party observations are submitted before the application has been published or when the Office itself finds that a ground for refusal has been overlooked. After the application is published, this option should be exercised only in clear-cut cases.

For more information, see the Guidelines, [Part B, Examination, Section 4, Absolute Grounds for Refusal](#).

## 3.2 Decisions

In all cases where the Office issues decisions against applicants, it must give the ground(s) for the decision. The decision(s) must address any pertinent arguments raised by the applicant in its observations. Decisions must not only refer to the appropriate parts of the EUTMR and EUTMDR/EUTMIR, but also give explicit reasons, except in the most obvious cases (for example, where a document is missing or a fee has not been paid).

Where, for example, a decision is given on the basis of internet searches, the Office must provide the applicant with proof of those searches.

### 3.2.1 Appeals

Articles [66](#) and [72](#) EUTMR

Decision [2009-1](#) of 16/06/2009 of the Presidium of the Boards of Appeal

Applicants have a right to appeal against a decision that terminates proceedings and that adversely affects them. For practical purposes, any decision issued by the Office that terminates proceedings and is not accepted by the applicant falls into this category. Any written communication of such a decision must also inform the applicant that the decision can be appealed within 2 months.

Appeals have suspensive effect. Within the period in which an appeal can be lodged, the Office should not take any steps that cannot easily be reversed (e.g. publication or entry in the Register). The same goes for the period up until a final decision is taken where a case is brought before the General Court (GC) or Court of Justice (CJ) of the European Union by an action under [Article 72 EUTMR](#).

## 3.3 International registrations designating the European Union

Details about the examination of an EUTM application as a result of the transformation of an IR designating the European Union are given in [the Guidelines, Part M, International Marks](#).

## 4 Publication

[Article 44 EUTMR](#)

[Article 7 EUTMIR](#)

Publication takes place if the application fulfils all the acceptance conditions.

Applications are published in all the official EU languages.

The examiner must ensure that the following details are available, where applicable:

1. application file number;
2. filing date;
3. representation of the trade mark;
4. indication of the collective mark or certification mark;
5. indication of the mark type other than word marks, for example figurative marks, shape marks, position marks, pattern marks, hologram marks, sound marks, colour marks, motion marks, multimedia marks and other marks;
6. description of the mark;
7. colour code(s);
8. figurative elements under the Vienna Classification;
9. acquisition of distinctive character through use;
10. applicant's name and address;
11. representative's name and address;
12. first and second language;
13. goods and services under the Nice Classification;
14. priority data as filed;
15. exhibition priority data as filed;
16. seniority data as filed;
17. transformation data.

Once the examiner has checked that all these elements are correct and the Office has received the translation in all the official EU languages, the application will be published.

## **5 Amendments to an EUTM Application**

This part of the Guidelines only covers issues that are relevant to EUTM application amendments.

For amendments to registered European Union trade marks, see [the Guidelines, Part E, Register Operations, Section 1, Changes in a Registration](#).

## 5.1 Withdrawal of an EUTM application

[Article 49](#), Articles [66\(1\)](#), [71\(3\)](#) and [72\(5\)](#) and [Article 146\(6\)\(a\) EUTMR](#)

[Article 58](#) and [Article 60](#) Rules of Procedure of the General Court (RPGC)

[Article 51](#) Rules of Procedure of the Court of Justice (RPCJ)

### 5.1.1 Declaration of withdrawal

An EUTM application can be withdrawn at any time up until a final decision is taken on its subject matter.

After the Office's first-instance decision, an application can be withdrawn at appeal level within the 2-month appeal period, even if no appeal was actually filed or up until the appeal is decided by the Boards of Appeal; this applies both to *ex parte* and *inter partes* proceedings (27/09/2006, [R 331/2006-G](#), Optima; 23/04/2014, [R 451/2014-1](#), SUPERLITE, § 18). The Office will confirm the withdrawal and close the case. The Office's database will be updated accordingly to reflect the withdrawal of the EUTM application.

At GC level, an application can be withdrawn within the 2-month appeal period, extended by a period of 10 days (on account of distance) pursuant to [Article 60](#) of the Rules of Procedure of the GC. The Boards of Appeal decision cannot be considered final within this period. The application can also be withdrawn up until completion of the appeal process before the GC.

At CJ level, an application can be withdrawn within the 2-month period for filing an appeal before the CJ, extended by a period of 10 days (on account of distance) pursuant to [Article 51](#) of the Rules of Procedure of the Court of Justice, or before the CJ has issued a final and binding decision (18/09/2012, [C-588/11 P](#), OMNICARE, EU:C:2012:576).

When the case is pending before the GC or the CJ, the applicant must request withdrawal of the EUTM application from the Office (not the GC or CJ). The Office will then inform the GC or CJ whether or not it finds the withdrawal acceptable and valid.

Any declaration of withdrawal of the EUTM application submitted after the expiry of the appeal period is inadmissible.

The **withdrawal of any pending appeal** (before the Boards of Appeal, the GC or the CJ) means that the **contested decision becomes final**. Consequently, the EUTM application may no longer be withdrawn thereafter.

There is no charge for a declaration of withdrawal but the declaration must be made in writing.

The declaration of withdrawal can be made in the first or second language indicated by the applicant in its EUTM application. The same applies during opposition proceedings

(see [the Guidelines, Part C, Opposition, Section 1, Opposition Proceedings, paragraph 6.2.1.5](#)).

### 5.1.2 Unconditional and binding character of the declaration

A declaration of withdrawal becomes effective upon receipt by the Office, provided that the Office does not receive a withdrawal of the declaration on the same day.

This means that if a declaration of withdrawal and a letter withdrawing that declaration both reach the Office on the same day (regardless of the actual time of receipt), the latter annuls the former.

Once a declaration becomes effective, it cannot be withdrawn.

A declaration of withdrawal is void where it contains conditions or time limitations. For example, it must not require the Office to take a particular decision or, in opposition proceedings, require the other party to make a procedural declaration. Such a requirement is simply viewed as a suggestion for resolving the case; the Office informs the opponent accordingly and may invite the parties to come to an amicable settlement. Furthermore, a declaration does not become effective if it is made for some goods and/or services (partial withdrawal) on condition that the Office accepts the application for the remaining goods and/or services. Such a declaration is simply viewed as a suggestion to enable the Office to arrive at an acceptable list of goods and services.

Where an applicant responds to an official action by filing a restricted list of goods and services (partial withdrawal), the Office checks whether the applicant is declaring the unequivocal withdrawal of the remaining goods and services or whether the amended list of goods and services is a proposal or counterproposal by the applicant, subject to the Office's agreement.

### 5.1.3 Action to be taken

The Office will process a declaration of withdrawal, ensure publication and entry in the Register of the full or partial withdrawal in the EUTM Bulletin (if the EUTM application has already been published) and, in the event of a full withdrawal, will close the EUTM application file.

For the consequences of full or partial withdrawal of the opposition procedure, see [the Guidelines, Part C, Opposition, Section 1, Opposition Proceedings](#).

Detailed information on the refund of application fees can be found in [the Guidelines, Part A, General Rules, Section 3, Payment of Fees, Costs and Charges](#).

## 5.2 Restriction of the list of goods and services in an EUTM application

[Article 49](#) and [Article 146\(6\)\(a\) EUTMR](#)

The applicant may restrict the list of goods and services of its EUTM application at any time, either of its own volition, in reply to an objection regarding classification or absolute grounds, or in the course of opposition proceedings.

In principle, declarations of restrictions follow the same rules as declarations of withdrawals; see [paragraph 5.1](#). This applies also to the language regime, meaning that the declaration can be filed in the first or second language of the EUTM application.

Where the case is pending before the GC or the CJ, the restriction must be filed with the Office, not with the GC or the CJ. The Office will then inform the GC or the CJ whether or not it finds the restriction acceptable and valid.

### 5.2.1 Procedural admissibility of a restriction

The restriction must be procedurally admissible; see [paragraph 5.1.2](#).

As a matter of principle, a restriction becomes effective on the date on which the Office receives it. The restriction can only be withdrawn if the withdrawal is received on the same date as the restriction itself.

Two requirements must be met in order for a restriction to be acceptable.

1. The new wording must not constitute an extension of the list of goods and services.
2. The restriction must constitute a valid description of goods and services and apply only to acceptable goods or services that appear in the original EUTM application.

For further details on restrictions of an EUTM application, see [the Guidelines, Part B, Examination, Section 3, Classification](#).

If these requirements are not met, the Office must refuse the proposed restriction and the list of goods and services will remain unchanged (14/10/2013, [R 1502/2013-4](#), REPRESENTATION OF A CIRCLE (fig.), § 12-16).

In any restriction request, the goods and/or services to be restricted must be clearly indicated.



### 5.3 Other amendments

[Article 49\(2\)](#) and [Article 55 EUTMR](#)

[Article 11 EUTMDR](#)

[Article 12 EUTMIR](#)

This paragraph and the legal provisions cited above solely concern amendments to the EUTM application requested by the applicant on its own initiative and not amendments or restrictions made following an examination, opposition or appeal procedure as a result of a decision by an examiner, Opposition Division or Board of Appeal.

Nor does this paragraph apply to the correction of errors in the Office's publications, which is carried out *ex officio* pursuant to [Article 44\(3\) and \(4\) EUTMR](#).

Amendments require a written request in accordance with the language regime (for more information, see the Guidelines, [Part B, Examination, Section 2, Formalities](#)).

There is no charge for this.

The following elements of an EUTM application may be amended:

- the name and address of the applicant or representative (see [paragraph 5.3.1](#));
- errors of wording or of copying, or obvious mistakes, provided that the correction does not substantially change the trade mark (for further details on such amendments, see the Guidelines, [Part B, Examination, Section 2, Formalities](#));
- the list of goods and services (see [paragraph 5.2](#)).

For amendments of regulations governing use of EU collective and EU certification marks, see the Guidelines, [Part E, Register Operations, Section 1, Changes in a Registration, paragraph 4, Changes in Collective and Certification Trade Mark Regulations](#).

### 5.3.1 Name and address of applicant or representative

Articles [55](#) and [111](#) EUTMR

[Article 2\(1\)\(b\) and \(e\) EUTMIR](#)

For information **on the change of name/address of the EUTM applicant**, including the name, legal form, and address, see the Guidelines, [Part A, General Rules, Section 5, Parties to the Proceedings and Professional Representation, paragraph 10, Change of name and address](#) and [paragraph 11, Correction of the name or address](#).

### 5.3.2 Recording and publication of amendments

[Article 49\(2\) EUTMR](#)

If an amendment is allowed, it will be recorded in the file and entered in the Register.

Where the EUTM application has not yet been published, it is published in the EUTM Bulletin in the amended form.

Where the EUTM application has already been published and (only) if the amendment concerns the list of goods and services or the representation of the mark, the EUTM application is published in its amended form in the EUTM Bulletin. The publication of the amended application may open a new opposition period of 3 months.

Any other amendments are not published separately but appear in the publication of the registration.

## 5.4 Division of an EUTM application

[Article 50 EUTMR](#)

[Article 8 EUTMIR](#)

An EUTM application can be divided into different parts not only as a result of a partial transfer (see the Guidelines, [Part E, Register Operations, Section 3, EUTMs and RCDs as Objects of Property, Chapter 1, Transfer](#)), but also on the EUTM applicant's own initiative. Division is particularly useful for isolating a disputed EUTM application for certain goods or services while maintaining the original application for the remainder. For information on the division of EUTMs, see the Guidelines, [Part E, Register Operations, Section 1, Changes in a Registration](#).

Whereas a partial transfer is free of charge and involves a change of ownership, there is a charge for a request for the division of an EUTM application, and the EUTM application remains in the hands of the same applicant. If the fee is not paid, the

request is deemed not to have been filed. The request can be made in the first or second language indicated by the applicant in its EUTM application.

For specific information on the division of international registrations designating the EU under the Madrid Protocol, please see the Guidelines, [Part M, International Marks, paragraph 5, Division](#).

#### 5.4.1 Requirements

A request for division must contain the following information:

- the file number of the EUTM application to be divided;
- the name and address or name and ID number of the applicant;
- the list of goods and services for the divisional application or, if more than one new application will be created, the list of goods and services for each divisional application;
- the list of the goods and services that will remain in the original EUTM application.

Furthermore, the goods and services of the divisional application must not overlap with the list of goods and services of the original application.

The Office will notify the applicant of any deficiency in this regard and give it 2 months to remedy the deficiency. If it is not remedied within this period, the request for division will be refused.

There are certain periods during which, for procedural economy or to safeguard third-party rights, division is not admissible. These periods are outlined below.

1. While an opposition is pending, only the non-contested goods and services may be hived off. The same applies if the case is pending before the Boards of Appeal or the Courts. The Office interprets the legal provisions cited above as preventing the applicant from hiving off some or all of the contested goods to form a new application that would cause the opposition proceedings to be split. If such a request for division is made, the applicant is given the opportunity to amend it by hiving off the non-contested goods and services.
2. Division is not admissible during the 3-month opposition period following publication of the application. Allowing a division during this time would counteract the aim of not splitting an opposition procedure and frustrate third parties, who have to rely on the EUTM Bulletin to know what to oppose.
3. Division is not admissible during the period before a filing date has been issued either. This does not necessarily coincide with the first month following filing. For further details on the filing date, see [the Guidelines, Part B, Examination, Section 2, Formalities](#).

For all practical purposes, in the period following publication of the application, division is only admissible if an opposition has been entered against the application and only for the non-contested part. The aim of the provisions cited is to allow the applicant to register its mark for the non-contested goods quickly, without having to wait for the outcome of a lengthy opposition procedure.

## 5.4.2 Acceptance

### Article 50(6) EUTMR

If the Office accepts the declaration of division, a new application is created as of the date of acceptance and not retroactively as of the date of the declaration.

The new application keeps the filing date and any priority and seniority dates. The seniority effect will then become partial.

All requests and applications submitted and all fees paid prior to the date on which the Office receives the declaration of division are also deemed to have been made or paid for the divisional application. However, fees duly paid for the original application are not refunded.

The practical effects of this provision are as follows.

- Where an application for the registration of a licence was made and payment of the registration fee was received by the Office prior to the declaration of division, the licence will be registered against the original registration and recorded in the file of the new registration. No further fees need be paid.
- Where an EUTM application claiming six classes is divided into two applications of three classes each, no class fees are payable as of the date the Office receives the declaration of division. However, fees paid prior to that date cannot be refunded.

Where the division is not accepted, the old application remains unchanged. It does not matter whether:

- the declaration of division was deemed not to have been filed because no fee had been paid;
- the declaration was refused because it failed to comply with the formal requirements;
- the declaration was found inadmissible because it was filed during one of the periods in which division is not admissible.

The fee will not be reimbursed in any of these three cases. The worst-case scenario for the applicant is that the declaration of division is not accepted, but this never affects the original application. The applicant can repeat the declaration of division later, on payment of a new fee.

## 5.4.3 New files and their publication

A new file is created for the divisional application, with all the documents that were on file for the original application, all the correspondence relating to the declaration of division and all future correspondence for the new application. Inspection of this file will be unrestricted under the general rules.

If the declaration of division concerns an EUTM application that has not yet been published, both the divisional and the original application are published separately and in the normal way, without any express reference to each other.

If the declaration of division concerns an EUTM application that has already been published, the fact that there has been a division is entered into the Register and published with reference to the original application. The new application must also be published with all the usual particulars; however, no new opposition period will be opened. Division is admissible only for goods for which an opposition period has already started but not been made use of.

**GUIDELINES FOR EXAMINATION OF  
EUROPEAN UNION TRADE MARKS**

**EUROPEAN UNION  
INTELLECTUAL PROPERTY OFFICE  
(EUIPO)**

***Part B***

***Examination***

***Section 2***

***Formalities***

## Table of Contents

<b>1 Introduction.....</b>	<b>204</b>
<b>2 Filing of Applications.....</b>	<b>204</b>
<b>2.1 Applicants.....</b>	<b>204</b>
<b>2.2 How a European Union trade mark application can be filed.....</b>	<b>204</b>
<b>3 The Fees.....</b>	<b>205</b>
<b>3.1 Fees in general.....</b>	<b>205</b>
<b>3.2 Basic fee deficiency.....</b>	<b>205</b>
<b>3.3 Class fee deficiency.....</b>	<b>206</b>
<b>3.4 Fee refunds upon withdrawal.....</b>	<b>206</b>
<b>4 Filing Date.....</b>	<b>206</b>
<b>4.1 Filing date requirements.....</b>	<b>206</b>
4.1.1 Fees.....	207
4.1.2 Request.....	207
4.1.3 Applicant.....	207
4.1.4 Representation of the mark.....	208
4.1.5 List of goods and services.....	211
<b>4.2 Filing date receipt.....</b>	<b>211</b>
4.2.1 Applications filed through the Office's User Area.....	211
4.2.2 Applications filed by other means.....	211
<b>5 Goods and Services.....</b>	<b>211</b>
<b>5.1 Classification.....</b>	<b>211</b>
<b>5.2 Specific filing date deficiency and e-filing applications.....</b>	<b>212</b>
<b>6 Languages/Translations.....</b>	<b>213</b>
<b>6.1 First and second languages.....</b>	<b>213</b>
<b>6.2 The correspondence language.....</b>	<b>214</b>
<b>6.3 Reference language for translations.....</b>	<b>215</b>
<b>6.4 Non-translatable elements.....</b>	<b>215</b>
<b>6.5 Restriction of goods and services.....</b>	<b>216</b>
<b>7 Applicant, Representative and Address for Correspondence.....</b>	<b>217</b>
<b>7.1 Applicant.....</b>	<b>217</b>
<b>7.2 Representative.....</b>	<b>217</b>

<b>7.3 Change of name/address.....</b>	<b>217</b>
<b>7.4 Transfer of ownership.....</b>	<b>218</b>
<b>8 Kind of Mark.....</b>	<b>218</b>
<b>8.1 Individual marks.....</b>	<b>218</b>
<b>8.2 Collective marks.....</b>	<b>218</b>
8.2.1 Character of collective marks.....	219
8.2.2 Applicants for collective marks.....	219
8.2.3 Regulations governing use of collective marks.....	219
8.2.3.1 Content of the regulations of use.....	219
8.2.3.2 Examination of formalities relating to the regulations of use.....	221
<b>8.3 Certification marks.....</b>	<b>221</b>
8.3.1 Character of certification marks.....	221
8.3.2 Applicants for certification marks.....	221
8.3.3 Regulations governing use of certification marks.....	222
8.3.3.1 Content of the regulations of use.....	222
8.3.3.2 Examination of formalities relating to regulations of use of certification marks.....	224
<b>8.4 Changes of kind of mark.....</b>	<b>224</b>
<b>9 Representation, description and type of mark.....</b>	<b>225</b>
<b>9.1 Representation.....</b>	<b>225</b>
9.1.1 Transparent elements or white elements.....	227
9.1.2 Dotted lines.....	227
<b>9.2 Description.....</b>	<b>230</b>
<b>9.3 Mark type.....</b>	<b>231</b>
9.3.1 Word marks.....	231
9.3.2 Figurative marks.....	232
9.3.3 Shape marks.....	234
9.3.4 Position marks.....	237
9.3.5 Pattern marks.....	238
9.3.6 Colour marks.....	239
9.3.7 Sound marks.....	242
9.3.8 Motion marks.....	243
9.3.9 Multimedia marks.....	246
9.3.10 Hologram marks.....	247
9.3.11 Other marks.....	248
9.3.11.1 Tracer marks.....	248
9.3.11.2 Smell/olfactory and taste marks.....	249



9.3.11.3 Tactile marks.....	249
9.3.12 Correction of mark type.....	250
9.3.12.1 General rules.....	250
9.3.12.2 Examples of recurring mark type deficiencies.....	250
<b>10 Series marks.....</b>	<b>253</b>
<b>11 Priority.....</b>	<b>253</b>
<b>11.1 Formal requirements.....</b>	<b>254</b>
11.1.1 Claiming priority.....	254
11.1.2 Priority documents.....	254
11.1.3 Language of previous application.....	255
11.1.4 Formal priority requirements not satisfied.....	255
<b>11.2 Substantive requirements for priority claims.....</b>	<b>255</b>
11.2.1 Principle of first filing.....	256
11.2.2 Triple identity.....	257
11.2.2.1 Identity of the marks.....	257
11.2.2.2 Identity of the goods and services.....	258
11.2.2.3 Identity of the owner.....	259
11.2.3 Substantive priority requirements not satisfied.....	259
<b>11.3 Examples of priority claims.....</b>	<b>259</b>
11.3.1 First filing.....	259
11.3.2 Comparison of the marks.....	260
11.3.3 Comparison of the goods and services.....	266
11.3.4 Priority claims based on series marks.....	267
11.3.5 Claiming priority for marks represented in a different format.....	267
11.3.5.1 Claiming the priority of an earlier national filing for an EUTM application.....	268
11.3.5.2 Claiming the priority of an earlier EUTM filing for a national application.....	268
<b>12 Exhibition Priority.....</b>	<b>268</b>
<b>13 Seniority.....</b>	<b>269</b>
<b>13.1 Harmonised seniority information.....</b>	<b>270</b>
<b>13.2 Seniority examination.....</b>	<b>270</b>
<b>13.3 Identity of the marks.....</b>	<b>272</b>
<b>13.4 Goods and services.....</b>	<b>272</b>
<b>13.5 Treatment of seniority examination deficiencies.....</b>	<b>272</b>
<b>13.6 Examples of seniority claims.....</b>	<b>273</b>
<b>14 Transformation.....</b>	<b>275</b>

<b>15 Amendments to the EUTM Application.....</b>	<b>276</b>
<b>15.1 Amendments to the representation of the mark.....</b>	<b>276</b>
<b>16 Conversion.....</b>	<b>278</b>

## 1 Introduction

Every European Union trade mark (EUTM) application must abide by certain formality rules. The purpose of these Guidelines is to lay down Office practice in relation to those rules.

## 2 Filing of Applications

### 2.1 Applicants

[Article 5 EUTMR](#)

For information **on who may be an applicant**, see the Guidelines, [Part A, Section 5, paragraph 1, Introduction — Parties to the Proceedings and Principle of Representation](#) and [paragraph 3, Identification of Parties to the Proceedings](#).

### 2.2 How a European Union trade mark application can be filed

[Article 30\(1\)](#) and [Article 100 EUTMR](#)

[Article 63\(1\) EUTMDR](#)

Decision No [EX-20-9](#) of the Executive Director of the Office of 03/11/2020 on communication by electronic means

Applications for an EUTM can only be filed directly with the Office.

EUTM applications may be filed electronically, by post or by courier. The Office offers the possibility of an accelerated procedure known as 'Fast Track' for applicants who file through the Office's User Area (for more details please check the [Office's website](#)).

### 3 The Fees

[Article 31\(2\)](#), [Article 32](#), [Article 41\(5\)](#) and Articles [179](#) and [180](#) and [Annex I EUTMR](#)

Decision No [EX-21-5](#) of the Executive Director of the Office of 21/07/2021 on payment methods of fees and charges and determining the insignificant amount of fees and charges

#### 3.1 Fees in general

For the application of an EUTM the following fees are applicable.

Trade Mark	Basic Fee (including one class)	Fee for a second class	Fee for each additional class
Individual mark	EUR 1 000	EUR 50	EUR 150
Individual mark filed electronically	EUR 850	EUR 50	EUR 150
Collective mark	EUR 1 800	EUR 50	EUR 150
Collective mark filed electronically	EUR 1 500	EUR 50	EUR 150
Certification mark	EUR 1 800	EUR 50	EUR 150
Certification mark filed electronically	EUR 1 500	EUR 50	EUR 150

The fee must be paid in euros. Payments made in other currencies are not valid.

For more information on fees, see [the Guidelines, Part A, General Rules, Section 3, Payment of Fees, Costs and Charges](#).

#### 3.2 Basic fee deficiency

If the basic fee is not paid within 1 month of the date the Office received the application, the provisional filing date will be lost (see [paragraph 4, Filing Date](#)).

However, the filing date can be maintained if evidence is submitted to the Office that the person who made the payment (a) duly gave an order within the relevant period to a banking establishment to transfer the amount of the payment, and (b) paid a surcharge of 10 % of the total amount due (up to a maximum of EUR 200).

The surcharge will not be due if the person submits proof that the payment was initiated more than 10 days before expiry of the 1-month time limit.

### **3.3 Class fee deficiency**

Where the application covers more than one class of goods and/or services, an additional class fee is payable for each additional class.

- Where the fee payment made or the amount covered by the current account is less than the total sum of fees due for the classes selected in the application form, a deficiency letter will be issued, setting a 2-month time limit for payment of the remaining amount. If the outstanding payment is not received within the specified time limit, the application will be deemed to be withdrawn for the classes not covered by the fee paid. In the absence of other criteria to determine which classes are intended to be covered by the amount paid, the Office will take the classes in the order of the classification (starting with the lowest class number).
- Where additional class fees become payable following the rectification of a classification deficiency, a deficiency letter will be issued, setting a 2-month time limit for payment. If payment is not received within the time limit specified, the application will be deemed to have been withdrawn for those classes resulting from the reclassification not covered by the fees actually paid. In the absence of other criteria to determine which classes are intended to be covered by the amount paid, the Office will take the classes in the order of the classification (starting with the lowest class number).

### **3.4 Fee refunds upon withdrawal**

On withdrawal of the EUTM application, the application fee (basic and class fees) will only be refunded in certain circumstances.

For more information on this, see [the Guidelines, Part A, General Rules, Section 3, Payment of Fees, Costs and Charges](#).

## **4 Filing Date**

Articles <a href="#">4</a> , <a href="#">31</a> , <a href="#">32</a> and <a href="#">41</a> EUTMR
---

### **4.1 Filing date requirements**

A filing date is accorded where the application fulfils the following requirements:

- the application is a request for the registration of an EUTM;
- the application contains information to identify the applicant;

- the application contains a representation of the trade mark that satisfies the requirements set out in [Article 4\(b\) EUTMR](#);
- the application contains a list of goods/services;
- the application fee has been paid within 1 month of filing the application.

If any of the above requirements are not met, a deficiency letter will be sent, requesting that the applicant submit the missing item within 2 months of the notification of the deficiency letter. This time limit is not extendable. If the deficiency is not remedied, the EUTM application will not be treated as an application for an EUTM ('deemed not filed') and all fees already paid will be reimbursed. If the missing information is submitted within the time limit set in the deficiency letter, the filing date will be changed to the date on which all mandatory information is complete, including the payment.

#### 4.1.1 Fees

Articles [31\(2\)](#) and [41\(3\) and \(5\)](#) EUTMR

The basic fee and, where appropriate, class fees, must be paid within 1 month of the filing of the application. Where the fee is not paid within 1 month the Office will issue a deficiency letter (see [paragraph 3.2, Basic fee deficiency](#), and [paragraph 5.2, Specific filing date deficiency and e-filing applications](#)).

#### 4.1.2 Request

[Article 31\(1\)\(a\) EUTMR](#)

[Article 65\(1\)\(a\) EUTMDR](#)

[Article 2\(1\)\(a\) EUTMIR](#)

The application must contain a request for the registration of an EUTM.

It is strongly recommended that the EUTM application is filed using the Office's e-filing form, available in the official languages of the European Union.

#### 4.1.3 Applicant

Articles [31\(1\)\(b\)](#) and [41\(1\)\(b\)](#) EUTMR

[Article 2\(1\)\(b\) EUTMIR](#)

For information **on the elements identifying the EUTM applicant, including the name, legal form and address**, see the Guidelines, [Part A, General Rules, Section 5, Parties to the Proceedings and Professional Representation, paragraph 3, Identification of Parties to the Proceedings](#).

4.1.4 Representation of the mark



Article 4, Article 31(1)(d) and Article 31(3) EUTMR



Article 2(1)(d) and Article 3 EUTMIR

The application must contain a representation of the mark that allows to determine the clear and precise subject matter of the protection requested in accordance with [Article 4\(b\) EUTMR](#). For further information on the different types of marks, please see [paragraph 9](#).

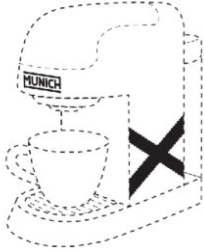
The representation will not be considered clear and precise where the representation of the mark (either filed on an A4 sheet or in a JPEG file) contains various versions of the same figurative sign (series / serial mark). In those cases, a filing date deficiency will be issued and the applicant will be invited to submit a new representation showing a single mark. The filing date will be the date when the amended representation is received by the Office.

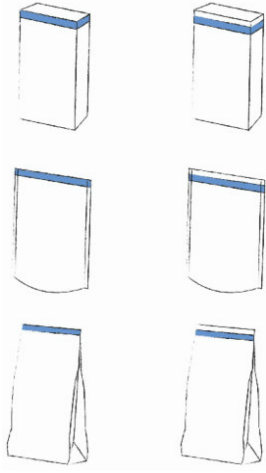

Examples

Representation No 1	Representation No 2	Explanation	EUTM No
		<p>The Office sent a filing date deficiency letter to the applicant as the representation initially submitted (representation 1) included two different elements within the same position mark, which were not connected to each other (therefore, two position marks). The EUTM applicant changed the representation to 'representation 2' and a filing date was consequently granted to the application.</p>	<p>EUTM No 17 912 403</p>

Representation No 1	Representation No 2	Explanation	EUTM No
		<p>The Office sent a filing date deficiency letter to the applicant as the representation initially submitted (representation 1) shows different positions on the good. The EUTM applicant changed the representation to 'representation 2' and a filing date was consequently granted to the application.</p>	<p>EUTM No 17 883 541</p>

Representation	Explanation	EUTM No
	<p>Five views that do not all show the same object.</p>	<p>EUTM No 6 910 021</p>



Representation	Explanation	EUTM No
	<p>Including text in addition to the representation of the mark is not allowed (text below the photo of the bottle).</p>	<p>EUTM No 7 469 661</p>
	<p>The first and third bottles show two different perspectives of the same bottle, both with a grey lid. The second bottle has a blue lid, and is therefore a different object to the first and third bottles. The fourth image is completely different, showing two bottle tops and a label. Of the four perspectives, only the first and third are views of the same object. Furthermore, including text in addition to the representation of the mark is not allowed.</p>	<p>EUTM No 9 739 731</p>
	<p>The first four images and the sixth image show the same shape mark from different perspectives. However, the fifth image is inconsistent with the others in that it shows a different shape mark, as it has been manipulated. Views of an object in a different state (e.g. open v closed) are not considered to be the same mark.</p>	<p>EUTM No 13 324 363</p>

#### 4.1.5 List of goods and services

[Article 31\(1\)\(c\)](#) and [Article 33 EUTMR](#)

[Article 2\(1\)\(c\) EUTMIR](#)

In order for a filing date to be accorded, there must be a list of goods and services. This list must comply with [Article 33 EUTMR](#).

To build their list of goods and services, applicants can select pre-approved terms from the Harmonised Database, which will be automatically accepted for classification purposes. Using these pre-approved terms will facilitate a smoother trade mark registration process.

For applications filed electronically, please see also [paragraph 5.2](#).

## 4.2 Filing date receipt

### 4.2.1 Applications filed through the Office's User Area

For EUTM applications filed through the Office's User Area, the system immediately issues an automatic electronic filing receipt, which contains the provisional filing date. The applicant should keep this receipt and verify that all data, including the mark representation, corresponds to what was intended to be applied for. Corrections will only be accepted if they were requested on the same date the application was filed.

### 4.2.2 Applications filed by other means

When an application is received other than through the Office's User Area, a provisional filing date is accorded and the Office issues a receipt with this filing date. The filing date will be considered the date of receipt if the application fulfils the filing date requirements.

## 5 Goods and Services

### 5.1 Classification

[Article 33\(1\) to \(6\) EUTMR](#)

Every EUTM application must contain a list of goods and services as a condition for being accorded a filing date (see [paragraph 4.1.5](#)).

The list must be classified in accordance with the [Nice Agreement](#).

The scope of protection defined by the original list of goods and services cannot be extended. If an applicant wants to protect additional goods or services after filing, a new application must be filed.

For further information on the classification of goods and services, please refer to [the Guidelines, Part B, Examination, Section 3, Classification](#).

## 5.2 Specific filing date deficiency and e-filing applications

[Article 31\(3\)](#), [Article 31\(1\)\(c\)](#) and Articles [41](#) and [100](#) EUTMR.

Decision No [EX-20-9](#) of the Executive Director of the Office of 3 November 2020 on communication by electronic means.

Decision No [EX-20-9](#) of the Executive Director of the Office of 3 November 2020 on communication by electronic means, [Annex I](#), Conditions of Use of the User Area.

E-filing applications are subject to Decision No [EX-20-9](#) of the Executive Director of the Office of 3 November 2020 on communication by electronic means and the associated [Annex I](#), covering the Conditions of Use of the User Area.

The list of goods and services must be entered in the text fields provided for that purpose.

Where the list of goods and services is filed totally or partially as an attachment to an e-filing application, or is filed separately, the application will not be considered as having been filed by electronic means and the corresponding higher fee for applications not filed by electronic means will apply.

In such cases, the Office will wait for the 1-month payment deadline to allow the applicant to pay the full basic fee and keep the original filing date. If the full basic fee is not paid at the end of that period, the Office will issue a filing date deficiency, requesting payment of the difference between the reduced basic fee for applications filed by electronic means and the standard basic fee, that is to say, EUR 150 for individual marks and EUR 300 for collective marks and certification marks within 2 months of the notification of the deficiency letter.

This time limit is not extendable. If the deficiency is not remedied, the EUTM application will be 'deemed not filed' and all fees already paid will be reimbursed. If the shortfall is paid within the set time limit, the filing date will be changed to the date on which the payment is complete (see [paragraph 4.1](#), Filing date requirements, and especially, [paragraph 4.1.1](#), Fees).

## 6 Languages/Translations

Articles [146](#) and [147](#) EUTMR

[Article 2\(1\)\(j\) EUTMIR](#)

An EUTM application may be filed in any of the official languages of the European Union. A second language must be indicated on the application form, which must be one of the five languages of the Office, namely English, French, German, Italian or Spanish.

A different language version of the application form from the language chosen as the first language may be used. However, the application form must be completed in that first language, including the list of goods and services and, where appropriate, the mark description.

### 6.1 First and second languages

All information on the application form must be in the first language; otherwise, a deficiency letter is sent. If the deficiency is not remedied within 2 months, the application will be rejected.

The second language serves as a potential language for opposition and cancellation proceedings. The second language must be different from the language selected as the first language. Under no circumstances can the choice of first and second language be changed once filed.

When filing the application, the applicant may choose to submit a translation into the second language of the list of goods and services and, where relevant, of any mark description. This is not a requirement because the Office arranges for translations. Moreover, if the list of goods and services is made up of terms that originate from the Harmonised Database there are translations available in all the relevant EU languages. If the applicant still insists on submitting its own translation, it is responsible for ensuring that the translation corresponds to the first language. It is very important for the applicant to ensure the accuracy of the translation as, in particular, the translation submitted by the applicant may be used as the basis for the translation of the application into all the remaining languages of the European Union (see [paragraph 6.3](#), Reference language for translations). In the case of any discrepancy, the language version that prevails depends on whether the first language is one of the five Office languages or not. If the first language of the application is one of the five Office languages, the first language version prevails. If the first language of the application is not one of the five Office languages, the second language prevails.

If a translation of goods and services is supplied in the second language, the Office will not verify the accuracy of the translation itself. The same applies in respect of the mark description (where appropriate). If there is an obvious discrepancy between the two

languages because, for example, the applicant has only submitted a partial translation of the goods and services and/or of the mark description, a deficiency letter will be sent, requesting that the additional translations be submitted within 2 months from notification of the deficiency. If the applicant fails to submit the omitted translations, then all translations submitted by the applicant will be disregarded and the Office will proceed on the basis of the first language as if no translation had been submitted.

## 6.2 The correspondence language

The correspondence language is the language used in correspondence between the Office and the applicant in examination proceedings until registration of the mark.

If the language that the applicant has selected as the first language is one of the five languages of the Office, then this will be used by the Office as the correspondence language.

Only where the language selected as the first language is not one of the five Office languages can the applicant indicate that it wants the correspondence language to be the second language. This request can be made on the application form by ticking the relevant box or can be requested later, either by explicit request, or implicitly by sending a communication to the Office in the second language. However, such a request will be refused where the Office has already issued a deficiency or objection letter in the first language.

In cases where the applicant selects one of the five Office languages as the first language but then indicates that the second language is to be the correspondence language, the Office will change the correspondence language to the first language and inform the applicant.

<b>Example</b>		
<b>First language selected</b>	<b>Second language selected</b>	<b>Correspondence language selected</b>
French	English	English
The correspondence language will be changed to French.		

The only exception to this rule is where a declaration of withdrawal or restriction has been submitted in the second language (English in the above example). The confirmation to the applicant will be issued in the language in which the declaration has been filed (English in the above example). See also [paragraph 6.5 Restriction of goods and services](#).

### 6.3 Reference language for translations

The list of goods and services is translated into the official languages of the EU. The source language for translations is defined as the reference language. This reference language will always be the language for classification.

1. If the first language of the application is one of the five Office languages, it will always be the reference language.
2. If the first language of the application is not one of the five Office languages and a translation into the second language has not been submitted, the first language will be the reference language.
3. If the first language is not one of the five Office languages and the applicant has submitted a translation of the goods and services in the second language, the reference language will be the second language and it will prevail in the event of discrepancies between the different linguistic versions (see [paragraph 6.1, First and second languages](#)).

The examination of the classification of the list of goods and/or services will be performed in the second language and when an objection (regarding classification or absolute grounds) results in an amendment of the list of goods and services, the applicant will be invited to submit both language versions of the new list:

- If the applicant submits the amended list only in the second language, the amendment will be disregarded and the Office will refuse the goods and/or services to which an objection has been raised.
- If the applicant submits the amended list in the first language only, the translation originally submitted by the applicant in the second language will be deleted and the list of goods and/or services will be translated by the Office into all the other EU languages including the second language.

### 6.4 Non-translatable elements

Before requesting translation of an application, ‘non-translatable elements’, for instance verbal elements or colour codes, will be identified as such by putting them into inverted commas (“”), as agreed as a formatting rule with the Translation Centre for the Bodies of the European Union (CdT).

#### Example

Where the (acceptable) mark description refers to a verbal element of the mark, this element should not be translated.

Mark description	Mark
------------------	------

<p>EUTM No 14 103 634</p> <p>This is a motion mark in colour. It consists of eight pictures, sequencing the following movement: The “Tide” brand logo appears from the left-hand side with increasing speed, leaving behind it a white swoosh, until it stops when it reaches the right-hand side of the screen. Because of the movement and speed, the logo is blurred until it stops, at which point it appears well defined. The whole movement lasts 2.5 seconds.</p>	
<p>EUTM No 15 922 883</p> <p>This is a motion trade mark in colour. The trade mark consists of the word “CHUBB” displayed in a series of colours. The series consists of the following order of colours: grey, purple, green, yellow, red, turquoise, orange, blue and pink. The word “CHUBB” is displayed in each of the colours in the series in turn. Each colour is displayed for approximately 10 seconds. When a sequence of the word “CHUBB” in the colours grey, purple, green, yellow, red, turquoise, orange, blue and pink has been completed, the sequence starts again from the beginning, with the word “CHUBB” being displayed first in the colour grey, as the first colour of the series, and then in each of the colours in the series in the same order as before. Again each colour is displayed for approximately 10 seconds.</p>	

## 6.5 Restriction of goods and services

Articles [49\(2\)](#) and [146\(6\)\(a\)](#) EUTMR

For information on the restriction of goods and services and languages, see the Guidelines, [Part B, Examination, Section 1, Proceedings, paragraph 5.2](#) and the Guidelines, [Part A, General Rules, Section 4, Languages, paragraph 5.1](#).

## 7 Applicant, Representative and Address for Correspondence

Articles [3](#), [5](#), [55](#), [119](#) and [120](#) EUTMR

[Article 74 EUTMDR](#)

[Article 2\(1\)\(b\) and \(e\) EUTMIR](#)

### 7.1 Applicant

For information **on the identifications elements of the EUTM applicant, including the name, legal form, and address**, see the Guidelines, [Part A, General Rules, Section 5, Parties to the Proceedings and Professional Representation, paragraph 3, Identification of Parties to the Proceedings](#).

### 7.2 Representative

If the applicant has its domicile, principal place of business or a real and effective industrial or commercial establishment in the European Economic Area (EEA), there is no obligation for it to be represented.

If the applicant does not have its domicile, principal place of business or a real and effective industrial or commercial establishment in the EEA, regardless of its nationality, representation must be sought to act for it in all proceedings except the filing of the EUTM application and the payment of the application fee. Every representative in the sense of [Article 120 EUTMR](#) who files an application with the Office is placed on the Representative database and given an ID number. If the representative has been allocated an ID number by the Office, it is sufficient to indicate only that number and his or her name.

For more information on representation, see the Guidelines, [Part A, General Rules, Section 5, Professional Representation](#).

### 7.3 Change of name/address

[Article 55](#) and [Article 111\(3\)\(a\)](#) EUTMR

For information **on the change of name/address of the EUTM applicant**, including the name, legal form and address, see [the Guidelines, Part A, General Rules, Section 5, Parties to the Proceedings and Professional Representation, paragraph 10, Change of name and address](#).



## 7.4 Transfer of ownership

[Article 20\(4\) and \(9\)](#) and Articles [28](#) and [111](#) EUTMR

[Article 13 EUTMIR](#)

EUTM registrations and applications may be transferred from the previous proprietor/applicant to a new proprietor/applicant, primarily by way of assignment or legal succession. The transfer may be limited to some of the goods and/or services for which the mark is registered or applied for (partial transfer). At the request of one of the parties, a transfer will be entered in the Register and published.

For more information on the recording of transfers of ownership see [the Guidelines, Part E, Register Operations, Section 3, EUTMs and RCDs as Objects of Property, Chapter 1, Transfer](#).

## 8 Kind of Mark

The EUTMR distinguishes between three kinds of marks: individual, collective and certification. The Office's decisions and communications will identify collective or certification marks, as appropriate.

### 8.1 Individual marks

[Article 5 EUTMR](#)

An individual mark is a kind of trade mark that indicates the commercial origin of the protected goods and/or services. Any natural or legal person, or person equivalent to these persons under the national law applicable to them, including authorities established under public law, may be the proprietor of a European Union individual trade mark, irrespective of their nationality.

### 8.2 Collective marks

Articles [41\(2\)](#) and Articles [74](#) to [76](#) EUTMR

[Article 16 EUTMIR](#)

For further information on collective marks, please see [the Guidelines, Part B, Section 4, Chapter 15, EU Collective Marks](#).

### 8.2.1 Character of collective marks

A collective mark is a specific kind of mark, described as such when the mark is applied for, that indicates that the goods or services protected by that mark originate from members of an association, rather than from just one trader. Collective does not mean that the mark belongs to several persons nor that it designates/covers more than one country.

Collective marks may be used together with the individual mark of the producer of a given good or of the service provider. This allows members of an association to differentiate their own products and/or services from those of competitors.

For further information on the substantive requirements of EU collective marks, see [the Guidelines, Part B, Examination, Section 4, Absolute Grounds for Refusal, Chapter 15, European Union Collective Marks](#).

### 8.2.2 Applicants for collective marks

Associations of manufacturers, producers, suppliers of services or traders that, under the terms of the law governing them, have the capacity in their own name to have rights and obligations of all kinds, to make contracts or accomplish other legal acts and to sue or be sued, as well as legal persons governed by public law, may apply for a collective mark. The applicant must be either an association in a formal sense or have an internal structure of an associative nature (for example, Spanish ‘Consejos Reguladores’ are regulatory councils, which are governed by public law but are organised under the form of associations).

For further information on the ownership requirements of EU collective marks, please see [the Guidelines, Part B, Examination, Section 4, Absolute Grounds for Refusal, Chapter 15, European Union Collective Marks](#).

### 8.2.3 Regulations governing use of collective marks

In addition to the information to be submitted when applying for an individual trade mark, applications for a European Union collective trade mark require the submission of regulations governing use of the mark.

The regulations governing use must be submitted within 2 months of the filing date of the application ([Article 75\(1\) EUTMR](#)).

The Office recommends use of its [template](#), specifically created to guide applicants through the process of drafting the regulations governing use.

#### 8.2.3.1 Content of the regulations of use

The regulations governing use referred to in [Article 75 EUTMR](#) must be set out in a stand-alone document and contain the obligatory information as required by [Article 16 EUTMR](#), namely:

1. the **name of the applicant**; (identical to the one given in the application form);
2. the **object of the association** or the object for which the legal person governed by public law is constituted;
3. the **bodies authorised to represent the association** or the said legal person (titles, such as director, association secretary; not personal names);
4. for associations, the **conditions for membership**; containing, when appropriate, the authorisation for others to become a member of the association when the mark designates the geographical origin of the goods and services and their goods and services originate in the geographical area concerned ([Article 75\(2\) EUTMR](#)) (regarding situations where authorisation is needed, see [the Guidelines, Part B, Section 4, Absolute Grounds for Refusal, Chapter 15, European Union Collective Marks, Point 4.1, Article 74\(2\) EUTMR: geographical derogation](#));

the rules concerning the conditions for membership must be specifically included in the regulations governing use; cross references to other documents are not sufficient;

5. the representation of the EU collective mark (**identical** to the sign applied for; no additional sign or possible variations of it should be reproduced except in the case of identical regulations of use filed by the same applicant in relation to other EU collective marks — all represented in the regulations of use);
6. the **persons authorised to use the mark**;

authorisation to use the mark is conditional upon membership of the association; however, in addition to membership, there can be additional requirements which, if they exist, must be set out;

the requirement to indicate the authorised persons can be met by referring to a general class of authorised person or by providing a specific list; such a list may be set out in the regulations of use or may be referenced by a hyperlink;

reference to authorised users as 'licensees' is to be avoided as it wrongly implies that authorisation to use the mark derives from being a party to a contract whereas it derives from membership of the association and compliance with the regulations of use;

non-members of the association cannot be authorised persons to use the mark, as this would contradict the definition of EU collective marks ([Article 74\(1\) EUTMR](#));

7. where appropriate, the **conditions governing use of the mark** applied for, including sanctions (e.g. where the mark is to be placed on the goods, or where a minimum size of the mark in relation to the goods is to be respected);
8. the **goods or services** covered by the EU collective mark (**identical** to the list of goods and services of the application), including, where appropriate, any limitation further introduced (e.g. as a consequence of the application of [Article 7\(1\)\(j\), \(k\) or \(l\) EUTMR](#)).

### 8.2.3.2 Examination of formalities relating to the regulations of use

#### 8.2.3.2.1 Regulations of use not submitted

If the regulations are not submitted with the application, a deficiency letter will be sent, setting a time limit of 2 months to submit them.

If the regulations are not submitted within this 2-month time limit, the application will be refused.

#### 8.2.3.2.2 Regulations of use submitted but with deficiencies

If the regulations have been submitted but fail to specify the required information, as listed in [paragraph 8.2.3.1](#), a deficiency letter will be sent, setting a time limit of 2 months to submit the missing information.

If the deficiency is not remedied within this 2-month time limit, the application will be refused.

For more details, please refer to [the Guidelines, Part B, Examination, Section 4, Absolute Grounds for Refusal, Chapter 15, European Union Collective marks](#).

## 8.3 Certification marks

Article [41\(2\)](#) and Articles [83](#) to [85](#) EUTMR

[Article 17 EUTMIR](#)

For further information on certification marks, please see [the Guidelines, Part B, Section 4, Chapter 16, EU Certification Marks](#).

### 8.3.1 Character of certification marks

An EU certification mark is an EU mark that is described as such when the mark is applied for and is capable of distinguishing goods or services that are certified by the proprietor of the mark in respect of material, mode of manufacture of the goods or performance of the services, quality, accuracy or other characteristics, **with the exception of geographical origin**, from goods and services that are not thus certified.

For further information on the substantive requirements of European Union certification marks, see [the Guidelines, Part B, Examination, Section 4, Absolute Grounds for Refusal, Chapter 16, European Union Certification Marks](#).

### 8.3.2 Applicants for certification marks

Any natural or legal person, including institutions, authorities and bodies governed by public law, may apply for EU certification marks, provided that such person does not carry on a business involving the supply of goods or services of the kind certified.

For further information on the substantive requirements of European Union certification marks, see [the Guidelines, Part B, Examination, Section 4, Absolute Grounds for Refusal, Chapter 16, European Union Certification Marks](#).

### 8.3.3 Regulations governing use of certification marks

In addition to the information to be submitted when applying for an individual trade mark, applications for a European Union certification mark require the submission of regulations governing use of the mark.

The regulations governing use must be submitted within 2 months of the filing date of the application ([Article 84\(1\) EUTMR](#)).

The Office recommends use of its [template](#), specifically created to guide applicants through the process of drafting the regulations governing use.

#### 8.3.3.1 Content of the regulations of use

The regulations governing use referred to in [Article 84 EUTMR](#) must be set out in a stand-alone document and contain the obligatory information as required by [Article 17 EUTMR](#), namely:

1. the **name of the applicant** ;
2. a **declaration** that the applicant complies with the requirements laid down in [Article 83\(2\) EUTMR](#), that is, a declaration by the applicant that it does not carry on a business involving the supply of goods and services of the kind certified;
3. the **representation** of the EU certification mark ( **identical** to the sign applied for; no additional sign or possible variations of it should be reproduced except in the case of identical regulations of use filed by the same applicant in relation to other EU certification marks — all represented in the regulations of use);
4. the **goods or services** covered by the EU certification mark ( **identical** to the list of goods and services of the application);
5. the **characteristics** of the goods or services to be certified by the EU certification mark, such as the material, mode of manufacture of the goods or performance of the services, quality or accuracy (taking into account that, according to [Article 83\(1\) EUTMR](#), the geographical origin of the goods or services can never be listed as a characteristic);

these characteristics must be clearly stated and may be described in general terms;

all the goods and services that are claimed in the application must be able to be covered by the/a characteristic given in the regulations governing use. The characteristic must be coherent with the goods and services (e.g. it would make no sense to certify that *jewellery* cannot be sugar-free). The characteristic(s) must be clearly specified and explained in respect of each of the goods and services or at least for general category of goods and services;

the certification scheme can be based on standards from official and/or private sources (e.g. EU regulations, DIN or ISO norms); in either case a reference to the

specific norms must be inserted in the regulations governing use together with a description in general terms of the same standards;

there is no need to detail or reproduce all technical aspects and specifications in the body of the regulations of use, it will suffice to refer to external sources and further documents by means of hyperlinks, even where they are not freely accessible online;

6. the conditions governing use of the EU certification mark, including sanctions;

the regulations governing use need to include specific **conditions of use of the mark applied for** imposed upon the authorised user such as whether there are **fees** to be paid in connection with the use of the mark, etc. It is also mandatory to specify the appropriate **sanctions** that apply if these conditions are not respected.

7. the **persons authorised** to use the EU certification mark;

the *authorised users* may be identified as follows:

- a. any person meeting the required standard of the characteristics being certified (point 5) and the conditions governing use (point 6);
- b. a specific category of persons linked to an open objective criteria;
- c. a list of authorised users included in the regulations governing use or accessible through a working internet link;

these users should be referred to in the regulations governing use as '**authorised users**' but never as 'licensees', since a licensing agreement serves a different purpose to that of the regulations.

8. how the certifying body is to **test the characteristics** and **to supervise use** of the EU certification mark.

The regulations of use must include the **testing methods of the characteristics being certified** and the **supervision** system of the use of the mark by the owner of the certification mark. The testing methods and supervision, which must be clearly set out in the regulations of use, must be real and effective and are the responsibility of the owner of the certification mark.

The applicant/owner does not necessarily need to carry out the tests or supervise the conditions of use itself. In some cases, it might be necessary to cooperate with more specialised external testers and/or supervisors. However, the testing methods and supervision can never be transferred to the authorised user of the mark through a self-monitoring programme as this would not guarantee the correct functioning of the certification mark system.

The measures can relate to the methods, sampling and frequency of the testing and supervision, the qualification of the persons carrying out the tests and the supervision, and the 'triggers' for additional or enhanced tests or supervision measures.

### 8.3.3.2 Examination of formalities relating to regulations of use of certification marks

#### 8.3.3.2.1 Regulations governing use not submitted

If the regulations are not submitted with the application, a deficiency letter will be sent, setting a time limit of 2 months to submit them.

If the regulations are not submitted within this 2-month time limit, the application will be refused.

#### 8.3.3.2.2 Regulations governing use submitted but with deficiencies

If the regulations have been submitted but fail to specify the required information, as listed in [paragraph 8.3.3.1](#), a deficiency letter will be sent, setting a time limit of 2 months to submit the missing information.

If the deficiency is not remedied within this 2-month time limit, the application will be refused.

## 8.4 Changes of kind of mark

When the EUTM application is not for an individual trade mark, the applicant must include a statement to the effect that the application is for the registration of an EU collective mark or an EU certification mark ([Article 2\(1\)\(i\) EUTMIR](#)) and it must fulfil the requirements of the corresponding kind of mark.

However, there might be circumstances under which the applicant, on the basis of [Article 49\(2\) EUTMR](#) can request a change of kind of mark because the kind selected upon application is **obviously** wrong. Where the request for such a change is accepted, the fee will be adapted accordingly.

Should the change requested be refused by the Office, the applicant will be informed and a time limit of 2 months will be set for observations.

Some examples of acceptable requests for change of kind of mark (provided there is no other indication in the file and that the applicant indeed meant to apply for the initially chosen kind of mark):

- a **natural person has** applied for a **collective mark**: the kind of mark can be changed to 'individual' since collective marks cannot be granted to natural persons;  
  
a legal person has applied for a collective mark/certification mark but **the regulations of use** submitted clearly support the change requested (if from the terminology used and/or the overall scheme reflected in the document is clear that it refers to another kind of mark, the change will be accepted);
- **the sign** contains an explicit reference to a 'collective mark' or 'certification mark': the kind of mark can be adjusted to indicate the reflected kind of mark;
- the sign contains a **PDO/PGI** and the mark has been applied as a certification mark: the kind of mark can be changed to 'collective' since, by nature, PDO/PGIs certify

the geographical origin of the goods and services and this kind of characteristic is banned from law for certification marks;

- the mark has been filed as a collective or certification mark and no regulations of **use** have been submitted: the kind of mark can be changed to ‘individual’.

EU certification marks have existed since 01/10/2017, which is their earliest possible filing date. Consequently, changes of kind of mark to ‘certification mark’ are excluded in case of individual and collective trade marks filed before 01/10/2017.

The kind of mark will never be changed after registration, irrespective of when it was filed.

## 9 Representation, description and type of mark

### 9.1 Representation

[Article 4](#), Articles [31](#), [41](#) and [49\(2\)](#) EUTMR

[Article 3\(1\)](#), [3\(2\)](#), [3\(3\)](#), [3\(5\)](#), [3\(6\)](#) and [3\(9\)](#) EUTMIR

Decision No [EX-20-9](#) of the Executive Director of the Office of 3 November 2020 on communication by electronic means

A trade mark may be represented in any appropriate form using generally available technologies as long as it can be reproduced on the Register in a clear, precise, self-contained, easily accessible, intelligible, durable and objective manner so as to enable the competent authorities and the public to determine with clarity and precision the subject matter of the protection afforded to its proprietor. The representation cannot be replaced by a description of the mark but the description, when given, must accord with the representation.

When figurative, shape, position, pattern, motion, multimedia marks, holograms or ‘other’ marks are to be registered in colour, a coloured reproduction of the mark must be filed with the application.

It is no longer possible to indicate the colour(s) appearing in the trade mark or give any colour code, with two exceptions – first, when colours form part of the trade mark representation and are also indicated as an integral part of any description given, and, second, when colours are indicated for the sole purpose of claiming priority in other jurisdictions. However, indications provided in the context of claiming priority will neither be published, translated nor appear in the EUTM Register (see [paragraph 11.3.5.2](#)).

If the applicant fails to submit a representation that satisfies the requirements of [Article 4\(1\)\(b\) EUTMR](#) when filing the EUTM application, a deficiency will be notified to the effect that no filing date can be accorded (see [paragraph 4](#)).



Where (in cases other than e-filing) the application contains a representation of the mark without specifying the desired mark type, the Office will grant a filing date and, based on the representation submitted, accord the appropriate mark type where possible and inform the applicant in writing, setting a 2-month time limit for observations. If the representation is submitted but the Office cannot accord any mark type *ex officio*, a formality deficiency will be issued and the applicant will be requested to remedy such deficiency within 2 months.

Where the applicant has selected a mark type that does not correspond to the mark representation, the mark type will be corrected following the indications set out under [paragraph 9.3.12](#).

As per [Article 3\(5\) EUTMIR](#), where the representation is provided electronically, the Executive Director of the Office determines the format and size of the electronic files. See Decision No [EX-20-9](#) of the Executive Director of the Office of 3 November 2020 on communication by electronic means.

In an application submitted through e-filing, the reproduction of the mark must be uploaded as a single JPEG file.

For those representations not provided electronically, [Article 3\(6\) EUTMIR](#) states that the trade mark must be reproduced on a single sheet of paper separate from the sheet on which the text of the application appears. The single sheet on which the mark is reproduced must contain all the relevant views or images and must not exceed DIN A4 size. A margin of at least 2.5 cm must be left all around.

The JPEG file or A4 sheet must contain only one representation of the mark as applied for and no additional information whatsoever (except the indication of the correct position of the mark where this is not obvious; see Article 3(6) and (7) EUTMIR). For shape marks, if various perspectives of the same shape are submitted, these perspectives must also be submitted as one JPEG file or on one A4 sheet.

When an application contains more than one JPEG or A4 sheet showing different marks, albeit very similar ones, the Office issues a deficiency letter, requesting the applicant to choose one mark from among the different variations. If the applicant wants to protect the others as well, it will have to file a new application for each of the other marks it wishes to register. When there is no response to the deficiency letter within the time limit set therein, the application will be rejected.

For more information on applications filed with more than one mark representation in one JPEG or on one A4 Sheet, such as series/serial marks, and filing date requirements, see paragraph 4.1.4 Representation of the mark.

According to [Article 3\(9\) EUTMIR](#) the filing of a sample or a specimen does not constitute a proper representation.

Finally, verbal elements consist of letters in the alphabet of any official EU language, and keyboard signs. Where a mark other than a word mark contains any such verbal element that is visible from the representation, including non-graphical representations, it must be included in the 'word element(s)' field of the application form. This allows the

mark to be searched for within the database and also forms the basis of the language check for marks that is carried out in all official languages of the EU.

### 9.1.1 Transparent elements or white elements

Where a background colour or shading is used to show that the mark consists of or contains a transparent element or of an element that is entirely in the colour white, the Office recommends that it be categorised as an ‘other’ type of trade mark, with a description explaining its features. For an example of a transparent element (the background in this case) see below:

	<p>EUTM No 17 914 208</p> <p>The mark description, which reads ‘the light grey colour is not part of the trade mark. This colour serves solely as background’, explains how the grey colour in the mark is to be understood.</p>
---	--

### 9.1.2 Dotted lines

The legislation only mentions dotted lines as a visual disclaimer for one type of mark (position marks). However, this does not exclude the use of dotted lines for other types of mark or for other purposes provided that they do not undermine the capacity of the representation of the mark to enable the competent authorities and the public to determine the clear and precise subject matter of the protection afforded.

There are three possible functions of dotted lines in EUTM representations.

1. To represent stylistic/decorative elements. In this case, the dotted lines form part of the subject matter of the registration (for example, in a figurative mark).
2. To visually identify disclaimed elements. For example:
  - a. disclaiming the goods on which a position mark is placed or affixed;
  - b. disclaiming 3D ( <sup>5</sup> ) parts of a shape mark.
3. To visually disclaim elements that **per se** do not form part of the subject matter of the registration but do form part of the overall impression of the mark by illustrating the particular manner in which variable elements interact with predetermined elements (e.g. to indicate a ‘placeholder’ for letters or numbers that may vary).

Where the type of mark has a description field, the **function that the dotted lines perform** can be clarified in the description.

Where there is no description field certain presumptions will be applied.

In particular, dotted lines in representation will be interpreted as follows by the Office.

<sup>5</sup> As opposed to letters of figurative elements in the shape mark.

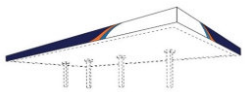
Type	Description	Role/treatment of dotted lines	Examples
Figurative	No	<p>It is not possible to visually disclaim elements from a figurative mark by means of dotted lines and they will be treated as a <b>stylisation</b> of the mark and examined as such.</p> <p>If it is clear that the dotted lines have another function and the type of mark they suggest would not be accord with the representation, a formalities deficiency will be raised (e.g. the representation of the filling station).</p>	 <p>EUTM No 18 605 906</p>  <p>Figure 1: EUTM No 18 430 094</p>

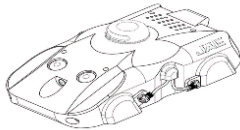
<p>Shape</p>	<p>No</p>	<p>Visually disclaiming 3D parts of shape marks with dotted lines is in principle acceptable (sometimes these are technical/functional parts).</p> <p>Even though applicants may seek protection for a shape mark by simply not including the disclaimed part in the representation, applicants may feel that this could lead to the trade mark being less effective, since the consumer might not recognise it as being part of the products they encounter (e.g. a shape mark for a USB stick that does not include the part that connects to the USB port would not be recognisable as a USB stick ( <sup>6</sup> )).</p> <p>Consequently, where the dotted lines are used in a manner that clearly distinguishes 3D parts of a shape mark, it is assumed that they function as visual disclaimers.</p> <p>However, verbal or numerical elements in dotted lines applied to/on the shape will be interpreted as being stylistic elements of the shape mark, and <b>not as visual disclaimers</b> (e.g. the letters JAE in the example).</p>	 <p>EUTM No 18 561 219</p>
--------------	-----------	--	---

Other	Optional	Dotted lines can be used to visually disclaim elements that <b>per se</b> do not form part of the subject matter of the registration but that do form part of the overall impression by illustrating the particular manner in which the variable elements <b>interact with other predetermined elements</b> in the representation. The description should not make claims that go beyond the representation (e.g. phrases like 'any word' or 'all forms') because that would extend the scope of the representation.	 <p>EUTM No 18 235 672</p>
-------	----------	--	---

## 9.2 Description

[Article 3\(2\)](#), [Article 3\(3\)\(d\) and \(e\)](#), [Article 3\(3\)\(f\)\(ii\)](#), [Article 3\(3\)\(h\)](#) and [Article 3\(4\) EUTMIR](#)

The EUTMIR stipulates for which mark types a mark description may be submitted by the applicant and defines the content of the description. In this sense, descriptions are only allowed for position marks ([Article 3\(3\)\(d\) EUTMIR](#)), pattern marks ([Article 3\(3\)\(e\) EUTMIR](#)), colour combination marks ([Article 3\(3\)\(f\)\(ii\) EUTMIR](#)), motion marks ([Article 3\(3\)\(h\) EUTMIR](#) — although only where still images are used), and 'other' marks ([Article 3\(4\) EUTMIR](#)). The content of each description, where allowed, is further explained below under each of these mark types.

Where the mark description is not in line with the EUTMIR or does not accord with the representation, the Office will issue a deficiency asking the applicant to amend or delete it. Where there is a conflict or discrepancy between the representation and the

<sup>6</sup> For an example showing the part of USB stick that goes into the PC, see Advocate General Mengozzi (14/09/2010, C-48/09 P, Lego brick, ECLI:EU:C:2010:41, § 73).

type and/or the description of the trade mark, the representation of the trade mark will always prevail and the description and/or type must be amended to accord with the representation.

Where goods and services are mentioned in the mark description field rather than in the field for goods and services, the Office will delete them from the mark description and, if the goods and services are not already covered in the specification, inform the applicant that it must add the goods and services.

This principle applies *mutatis mutandis* in all cases where necessary information on the mark is included in the wrong field of the application form.

After the mark has been filed, a mark description can be amended or added in order to submit more detailed information. However, such amendment must not alter the nature of the mark and must accord with the representation. Amendment of the description is not possible after registration ([Article 54\(1\) EUTMR](#)).

### 9.3 Mark type

Article [4](#), Article [7\(1\)\(a\)](#), Articles [31](#) and [41](#) and Article [49\(2\)](#) EUTMR

[Article 3\(3\) EUTMIR](#)

The categorisation of marks serves a number of functions. Firstly, it establishes the legal requirements for each type of mark; secondly, it can help the Office and other economic operators to understand what the applicant is seeking to register; and finally, it facilitates searches in the Office database.

In the framework of the European Union Intellectual Property Network ([EUIPN](#)), the Office and a number of trade mark offices in the European Union have agreed on a Common Practice in relation to new types of marks: examination of formal requirements and grounds for refusal. They agreed on examples of acceptable representations of sound marks, motion marks, multimedia marks and hologram marks. Some examples are reproduced below, and further examples can be found in the [Common Communication on New Types of Marks: Examination of Formal Requirements and Grounds for Refusal \(CP11\)](#).

The examples of mark types in these Guidelines are given only in the context of formalities' issues without prejudice to the outcome of the examination proceedings or to their scope of protection.

#### 9.3.1 Word marks

A word mark is a typewritten mark with elements including letters (either lower or upper case), words (either in lower- or upper-case letters), numerals or standard typographic characters.

A word mark must be represented by submitting a reproduction of the sign in standard script and layout, without any graphic feature or colour. Standard layout is to be understood as written across a single line.

The Office accepts signs in the alphabet of any official EU language as a word mark. Any sign consisting of words from another alphabet will have to be filed as a figurative mark (see also [paragraph 9.3.2 Figurative marks](#)).

A mark consisting of text in non-standard layout, for instance written across more than one line, will not be categorised as a word mark, as these marks are considered to be figurative.

Examples of acceptable word marks (for formalities' purposes)	
EUTM No 6 892 351	europadruck24
EUTM No 6 892 806	TS 840
EUTM No 6 907 539	4 you
EUTM No 2 221 497	ESSENTIALFLOSS
EUTM No 631 457	DON'T DREAM IT, DRIVE IT
EUTM No 1 587 450	?WHAT IF!
EUTM No 8 355 521	ΕΙΔ ΕΛΛΗΝΙΚΟ ΙΝΣΤΙΤΟΥΤΟ ΔΙΑΤΡΟΦΗΣ (Greek)
EUTM No 8 296 832	Долината на тракийските царе (Cyrillic)

### 9.3.2 Figurative marks

A figurative mark is a mark consisting of:

- exclusively figurative elements;
- a combination of verbal and figurative or otherwise graphical elements;
- verbal elements in non-standard fonts;
- verbal elements in colour;
- verbal elements on more than one line;
- letters from non-EU alphabets;
- signs that cannot be reproduced by a keyboard;
- combinations of the above.



A figurative mark must be represented by submitting a reproduction of the sign, showing all its elements and, where applicable, its colour(s).

The representation may be submitted in one single JPEG file or on one single A4 sheet.

It is not possible to file a description or indication of colour for figurative marks. The representation of the trade mark alone defines the subject matter of the registration.

Examples of figurative marks (for formalities' purposes)	
EUTM No 1 414 366 Purely graphic element	
EUTM No 9 685 256 Purely graphic element	
EUTM No 4 705 414 Combination of graphic element and text in standard font	
EUTM No 9 687 336 Combination of stylised font and figurative elements	
EUTM No 4 731 725 Combination of stylised font and figurative elements	
EUTM No 9 696 543 Verbal element in stylised font	
EUTM No 2 992 105 Verbal elements in stylised font	

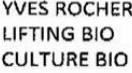

Examples of figurative marks (for formalities' purposes)	
EUTM No 9 679 358 Verbal elements in different fonts	
EUTM No 9 368 457 Verbal elements only, over more than one line	
EUTM No 9 355 918 Slogan in two different fonts, letters in different sizes, on more than one line	
EUTM No 9 681 917 Mark represented in non-EU characters (Chinese characters)	

### 9.3.3 Shape marks

A shape mark is a mark consisting of, or extending to, a three-dimensional shape, including containers, packaging, the product itself or its appearance. The term 'extending to' means that shape marks cover not only shapes per se, but also shapes that contain other elements, such as word elements, figurative elements or labels.

The shape mark may be represented by either a graphic representation of the shape or a photographic reproduction. The meaning of a graphic representation is extended to comprise the use of new technology, thereby allowing the filing of computer-generated images or animated designs in file formats OBJ, STL and X3D, with a maximum size of 20 MB.

Where the EUTM application for a shape mark is intended to be used as the basis for an international application under the Madrid Protocol, the applicant should consider whether the contracting parties that it wishes to designate accept computer-generated images or animated designs. Consult the [acceptable formats](#) for representation of a mark before each Office.

Where the representation is not a computer-generated image, it may contain up to six perspectives of the same shape. The different views must be submitted in one single JPEG file or on one single A4 sheet. While different perspectives may be filed, a single view of the shape is sufficient where the shape to be protected can be ascertained from that single view.

Where an applicant files different perspectives of a three-dimensional object on more than one sheet of paper, a deficiency will be raised, setting a time limit for the applicant to indicate which one of the representations filed will be the representation of the EUTM application. Likewise, where a single JPEG file or a single A4 sheet consists of more than six perspectives of the same three-dimensional shape, a deficiency will be raised, setting a time limit for the applicant to remove the perspective(s) exceeding the maximum number allowed, provided that the amendment does not substantially change the mark as filed.

If no mark type is indicated and only one view has been submitted, from which it cannot be inferred that the sign consists of or extends to a 3D shape, the Office will treat the representation as a figurative trade mark.

Example

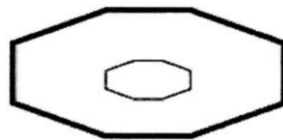

No mark type was selected for this sign. The Office will treat it as a figurative mark.

It is not possible to file a description or indication of colour for shape marks. The representation of the trade mark alone defines the subject matter of the registration.

<b>Examples of acceptable representations of shape marks (for formalities purposes)</b>	
<p>EUTM No 4 883 096</p> <p>Four different drawings of the same object</p>	
<p>EUTM No 4 787 693</p> <p>Six photographs of the same object from different perspectives, with text</p>	

<b>Examples of acceptable representations of shape marks (for formalities purposes)</b>	
<p>EUTM No 30 957</p> <p>Two photographs in colour showing different perspectives of the same object</p>	
<p>EUTM No 8 532 475</p> <p>Six views in colour showing six different perspectives of the same object</p>	
<p>EUTM No 14 419 758</p> <p>Combination of photographs and drawings showing the same object</p>	
<p>EUTM No 17 287 806</p> <p>One view of the object</p>	

### 9.3.4 Position marks

A position mark is a trade mark consisting of the specific way in which the trade mark is placed on or affixed to the product.

This type of mark must be represented by submitting a reproduction that identifies appropriately the position of the mark and its size or proportion with respect to the relevant goods. The representation may be submitted in one single JPEG file or on one single A4 sheet.

The representation should clearly define the position of the mark and its size or proportion with respect to the relevant goods. The elements that do not form part of the subject matter of the registration must be visually disclaimed, preferably by broken or dotted lines. A description that accords with the representation of the mark may be added to indicate how the sign is affixed to the goods. This cannot, however, serve as a substitute for a visual disclaimer. Colours, to the extent that they form an integral part of the description, may be indicated therein.

A description that infers that the position of the mark may vary with respect to the goods, for example 'The mark consists of [description of the device] applied to the outside of the goods', is not acceptable. In this case, the Office will notify a formality deficiency, requesting the applicant to amend or delete the description, as the position of the mark must be clearly defined with respect to the relevant goods.

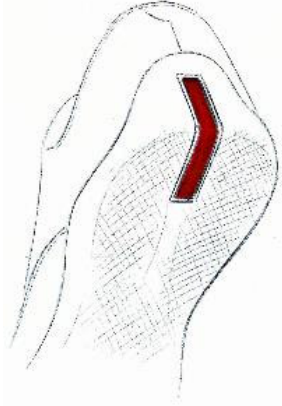
Examples of acceptable mark description for position mark (for formalities' purposes)	
<p>EUTM No 1 027 747</p> <p><u>Mark type</u>: Position mark</p> <p><u>Description</u>: Red stripe placed longitudinally along an item of footwear partly covering the rear area of the sole and partly the rear area of the item of footwear. Any moulding seen on the sole or on the rear part of the item of footwear and/or production characteristics are not part of the trade mark.</p>	

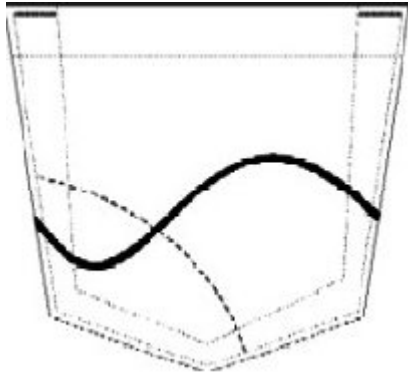
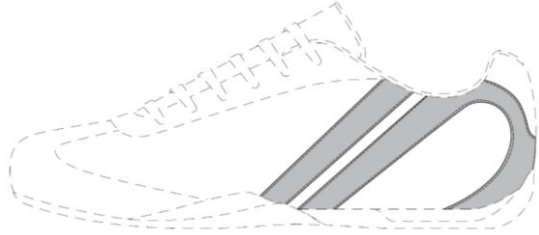
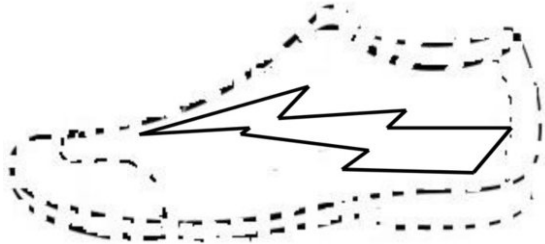
<b>Examples of acceptable mark description for position mark (for formalities' purposes)</b>	
<p>EUTM No 6 900 898</p> <p><u>Description:</u> Two Curves Crossed in One Point Design inserted in a Pocket; the mark consists of a decorative stitching made of Two Curves Crossed in One Point Design inserted in a Pocket; one of the curves is characterised by an arched form, drawn with a fine stroke, while the second one is characterised by a sinusoidal form, drawn with a thick stroke; the unevenly broken lines represent the perimeter of the pocket to which the applicant makes no claim and which serves only to indicate the position of the mark on the pocket.</p>	
<p>EUTM No 8 586 489</p> <p><u>Description:</u> The trade mark is a position mark. The mark consists of two parallel lines positioned on the outside surface of the upper part of a shoe. The first line runs from the middle of the sole edge of a shoe and slopes backwards towards the instep of a shoe. The second line runs parallel with the first line and continues in a curve backwards along the counter of a shoe to the heel of a shoe and ends at the sole edge of a shoe. The dotted line marks the position of the trade mark and does not form part of the mark.</p>	
<p>EUTM No 17 473 621</p> <p>Position mark without description</p>	

### 9.3.5 Pattern marks

A pattern mark is a trade mark consisting exclusively of a set of elements that are repeated regularly.

This type of mark must be represented by submitting a reproduction showing the pattern of repetition in one single JPEG file or on one single A4 sheet.

The representation of the pattern mark may be accompanied by a description detailing how its elements are repeated regularly. Such description must accord with the representation and not extend its scope. Colours, to the extent that they form an integral part of the description, may be indicated therein.

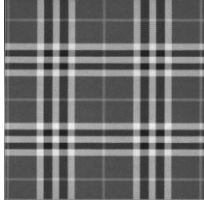
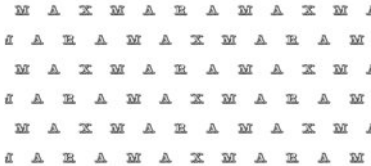
Examples of acceptable pattern marks (for formalities' purposes)	
EUTM No 15 602	
EUTM No 7 190 929	
EUTM No 17 865 439	

### 9.3.6 Colour marks

[Article 49\(2\) EUTMR](#)

[Article 3\(3\)\(f\) EUTMIR](#)

A colour mark is a trade mark that consists exclusively of a single colour without contour or a combination of colours without contours. What is protected is the shade of colour(s) and, in the case of more than one colour, the systematic arrangement of the colours in a predetermined and uniform way (24/06/2004, [C-49/02](#), Blau/Gelb, EU:C:2004:384, § 33; 14/06/2012, [T-293/10](#), Colour per se, EU:T:2012:302, § 50).



The representation of a colour mark must consist of a representation of the colour or colours without contours in one single JPEG file or on one single A4 sheet. Where there is more than one colour, the reproduction must show the systematic arrangement of the colour combination.





It is mandatory to file a reference to a generally recognised colour code, such as Pantone, Hex, RAL, RGB or CMYK. Where the colour code(s) clearly do(es) not correspond to the representation, the Office will issue a deficiency.

If the colour code has not been indicated in the application, the Office will notify the deficiency, allowing 2 months for the information to be submitted. If the colours are indicated in words instead of colour codes in the relevant field of the application form for the indication of colours, the Office will remove such colour indications and issue a deficiency letter asking the applicant to indicate the colour codes accordingly.

A description detailing the systematic arrangement of the colours is merely optional and references to colours in words in the mark description are accepted.

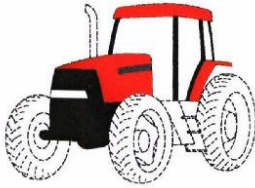
If the representation contains other elements, such as words, it is not a colour mark per se but a figurative mark. For information on correction of the mark type, see [paragraph 9.3.12](#).

<b>Examples of acceptable colour marks (for formalities' purposes)</b>	
<p>EUTM No 11 055 811</p> <p><u>Description:</u> The mark consists of five stripes of colour arranged horizontally and directly adjoining each other, their length being several times larger than their height. The colour distribution from the top to the bottom is: very light green, light green, medium green, dark green and very dark green. Proportion of the five colours: 20 % each.</p>	
<p>EUTM No 2 346 542</p> <p>03/05/2017, <a href="#">T-36/16</a>, GREEN STRIPES ON A PIN, EU:T:2017:295</p> <p><u>Colour indication:</u> RAL 9018; NCS S 5040G50Y + RAL 9018 1 : 4; NCS S 5040G50Y + RAL 9018 2 : 3; NCS S 5040G50Y + RAL 9018 3 : 2; NCS S 5040G50Y + RAL 9018 4 : 1; NCS S 5040G50Y.</p> <p><u>Description:</u> none</p>	

Examples of acceptable colour marks (for formalities' purposes)	
<p>EUTM No 9 045 907</p> <p><u>Description:</u> The mark consists of the combination of the colours red, black and grey as applied to the exterior surfaces of a tractor, namely red as applied to the bonnet, roof and wheel arches, light and dark grey as applied to the bonnet in a horizontal stripe and black as applied to the front bonnet grill, chassis and vertical trim — as depicted in the illustrative representation attached to the application</p>	 <p>(This mark was applied for as 'other' under the previous regime, indicating that it was a position mark. The example is given here to show that it can also be filed as a colour mark (combination of colours), showing how the combination appears on the products.)</p>
<p>EUTM No 17 972 757</p> <p>No description provided</p> <p>(Colour indication: PANTONE 376, PANTONE Process Black C)</p>	
<p>EUTM No 17 638 834</p> <p><u>Description:</u> The mark consists of the following colours: Beige "(Pantone 454 C)", dark grey "(Pantone 425 C)" and terracotta "(Pantone 159)"; the upper part of the mark is beige, the lower part of the mark is dark grey and below the middle of the beige area is a terracotta stripe.</p>	
<p>EUTM No 17 407 586</p> <p><u>Description:</u> The trade mark consists of three horizontal bars (from top to bottom): blue ("Pantone 273C"), green ("Pantone 370C"), blue ("Pantone 273C"). The bars have the following height ratios: blue 17.62 %, green 27.1 %, blue 55.24 % (from top to bottom).</p>	



Examples of acceptable colour marks (for formalities' purposes)	
<p>EUTM No 17 866 834</p> <p><u>Description:</u> The three colours have identical proportions of 33.33 % each. "(PANTONE:376c)"; "(PANTONE:2935c)"; "(PANTONE:white)".</p>	

### 9.3.7 Sound marks

A sound mark is defined as a trade mark consisting **exclusively** of a sound or combination of sounds. Therefore, trade marks combining sounds with, for example, movement do not qualify as sound marks per se and should be applied for as multimedia marks (see [paragraph 9.3.12](#)).

A sound mark must be represented by submitting either an audio file reproducing the sound or an accurate representation of the sound in musical notation.

The audio file must be in MP3 format and its size cannot exceed two megabytes. Office requirements do not allow the sound to stream or loop. Attachments that do not comply with these criteria will be deemed not to have been filed.

An audio file may be submitted only in e-filings. The Office will not accept an electronic sound file separately from the application.



Where the EUTM application for a sound mark is intended to be used as the basis for an international application under the Madrid Protocol, the applicant should consider whether the contracting parties that it wishes to designate accept audio files. The acceptable formats for representation of a mark before each Office can be consulted [here](#).

Musical notations may be submitted in one single JPEG file or on one single A4 sheet. 'Accurate musical notation' means that the representation must include all the elements necessary to determine its clear and precise subject matter of protection. The tempo or speed of the melody and the instrument(s) are optional elements to be indicated.

If the applicant submits both an audio file and musical notations, it will be asked to choose which of the two it wishes to retain. If the applicant submits an audio file and a representation of a sonograph, the sonograph will be removed from the file by the Office.

It is not possible to file a description for sound marks. The representation of the trade mark alone defines the subject matter of the registration.

Some examples of acceptable sound marks are also provided by the [Common Communication on New Types of Marks: Examination of Formal Requirements and Grounds for Refusal \(CP11\)](#).

Example of acceptable sound marks	
EUTM No 6 596 258 Musical notation including musical directions	
EUTM No 17 818 329	
EUTM No 17 700 361 Voice saying 'Barca'	<a href="#">Link</a>
EUTM No 17 672 932 Six notes on a piano	<a href="#">Link</a>
EUTM No 17 572 173 Two notes on a keyboard followed by a whizzing sound	<a href="#">Link</a>
CP11 example 'Gerivan' sung	<a href="#">Link</a>
CP11 example Random melody	<a href="#">Link</a>

### 9.3.8 Motion marks

A motion mark is defined as a trade mark **consisting of, or extending to**, a movement or a change in the position of the elements or of the colours of the mark. Trade marks combining movement with sounds do not qualify as motion marks and should be applied for as multimedia marks (see [paragraph 9.3.12](#)). The term '**extending to**' means that, in addition to the movement itself, the mark may also include words, figurative elements, labels, etc.



A motion mark must be represented by submitting either a video file or a series of still sequential images showing the movement or change of position. The video file must be in MP4 format and may not exceed 8 000 Kbps (kilobytes per second) and 20 MB.



A video file may be submitted only when e-filing. The Office will not accept a video file separately from the application.

Where the EUTM application for a motion mark is intended to be used as the basis for an international application under the Madrid Protocol, the applicant should consider whether the contracting parties that it wishes to designate accept video files. Consult the [acceptable formats](#) for representation of a mark before each Office.

The number of images is practically unlimited as long as they all fit in one single JPEG file or on one single A4 sheet. The still images may be numbered and/or accompanied by a description explaining the sequence.

The representation of the motion mark may be accompanied by a description. Such description must accord with the representation and not extend its scope. Colours, to the extent that they form an integral part of the description, may be indicated therein, as may the duration, repetitions and the speed of the motion/movement.

Example of motion marks	
<p>EUTM No 5 338 629</p> <p><u>Description:</u> the mark is an animated sequence with two flared segments that join in the upper-right portion of the mark. During the animation sequence, a geometric object moves up adjacent to the first segment and then down adjacent to the second segment, while individual chords within each segment turn from dark to light. Stippling shown in the mark is for shading only. The entire animated sequence lasts between 1 and 2 seconds.</p>	
<p>EUTM No 17 279 712</p> <p>A round green shape rotating on a black background</p>	 <p style="text-align: left; margin-top: 10px;"><a href="#">Link</a></p>

Example of motion marks	
<p>EUTM No 17 894 400</p> <p>The words 'WIN WIN' represented with changing letter sizes</p>	 <p style="text-align: right;"><a href="#">Link</a></p>
<p>CP11 example</p> <p>'Gerivan' bounce</p>	 <p style="text-align: right;"><a href="#">Link</a></p>
<p>CP11 example</p> <p>Cat changing colour</p>	 <p style="text-align: right;"><a href="#">Link</a></p>

### 9.3.9 Multimedia marks



A multimedia mark is defined as a trade mark **consisting of, or extending to**, the combination of image and sound. The term ‘**extending to**’ means that the mark may also include words, figurative elements, labels, etc. in addition to the image and sound.

A multimedia mark can only be represented by submitting an audiovisual file containing both the image and the sound and can therefore only be filed via e-filing. The Office will not accept an audiovisual file separately from the application. The audiovisual file must be in MP4 format and may not exceed 8 000 Kbps (kilobytes per second) and 20 MB.

Where the EUTM application for a multimedia mark is intended to be used as the basis for an international application under the Madrid Protocol, the applicant should consider whether the contracting parties that it wishes to designate accept audiovisual files. Consult the [acceptable formats](#) for representation of a mark before each Office.

It is not possible to file a mark description or indication of colour for multimedia marks. The representation of the trade mark alone defines the subject matter of the registration.

The presence of a black or white screen in the file combined with a sound does not preclude the mark from being classified as a multimedia mark, and neither does the partial absence of sound combined with an image.

Example of multimedia marks	
<p>EUTM No 17 635 293</p> <p>Moving characters ‘UOC’ on a blue background accompanied by a musical tone, moving across to be completed with the words ‘Universitat Oberta de Catalunya’.</p>	 <p style="text-align: center;"><a href="#">Link</a></p>
<p>EUTM No 17 411 315</p> <p>A hat, the band of which is stuffed with bank notes, moving slowly backwards to reveal a blue and white ball, all accompanied by a drum roll.</p>	 <p style="text-align: center;"><a href="#">Link</a></p>

Example of multimedia marks	
<p>CP11 example</p> <p>'Gerivan' sung, with word appearing.</p>	 <p><a href="#">Link</a></p>

### 9.3.10 Hologram marks

A hologram mark is defined as a trade mark consisting of elements with holographic characteristics. Therefore, a hologram is an image that changes its appearance when looked at from different angles.

1. A hologram can be a physical flat structure that uses light diffraction to create visual images. Its flat surface, under proper illumination, appears to contain a three-dimensional image or other visual effects. In this case, a three-dimensional effect is actually a two-dimensional visual effect that is perceived by human brains as three-dimensional.
2. A hologram can be a digital projection or visualisation of an object displayed via light field displays. Through them, three-dimensional objects and object compositions can be visualised and seen as such. These lifelike images can be seen but not touched.

A hologram mark must be represented by submitting either a video file or a graphic or photographic reproduction containing the views necessary for sufficiently identifying the holographic effect in its entirety.

The video file must be in MP4 format and may not exceed 8 000 Kbps (kilobytes per second) and 20 MB. A video file may be submitted only via e-filing. The Office will not accept a video file separately from the application.

The number of views is unlimited as long as they all fit in one single JPEG file or on one single A4 sheet.

Where the EUTM application for a hologram mark is intended to be used as the basis for an international application under the Madrid Protocol, the applicant should consider whether the contracting parties that it wishes to designate accept video files. Consult the [acceptable formats](#) for representation of a mark before each office.

It is not possible to file a description or indication of colour for hologram marks, as the representation of the trade mark alone defines the subject matter of the registration.

**Example of hologram marks**

CP11 example

'Gerivan' rotating



[Link](#)

### 9.3.11 Other marks



'Other' marks are marks that are not covered by [Article 3\(3\) EUTMIR](#). 'Other' marks must comply with the requirements for representation as stipulated in [Article 3\(1\) EUTMIR](#) and may be accompanied by a mark description, for example to specify what is meant by 'other'.

The mark description must accord with the representation and confirm that the mark type cannot be identified under the mark types mentioned above. If the description does not coincide with the representation, the Office will request that the applicant amend or delete it. Colours, to the extent that they form an integral part of the description, may be indicated therein.

Some examples of 'other' marks are discussed below.

#### 9.3.11.1 Tracer marks

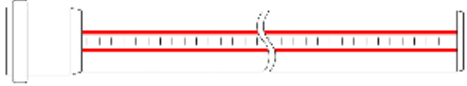
Tracer marks are coloured lines or threads applied to certain products, and are popular in the textile industry. Other examples are coloured lines on hoses or cables. The mark description could indicate that the mark is a 'tracer mark'.

Examples of acceptable tracer marks and descriptions (for formalities' purposes)	
<p>EUTM No 7 332 315</p> <p><u>Description:</u> The trade mark consists of a pipe, tube or extruded profile with continuous thin black horizontal lines set at an equal distance apart on the exterior of the pipe, tube or extruded profile, between two parallel red lines running along the length of the pipe, tube or extruded profile.</p>	
<p>EUTM No 3 001 203</p> <p><u>Description:</u> Golden band incorporated into a light-coloured functional band, in particular a lead band, for curtains, drapes, table covers and similar goods as an identifying marking.</p>	

### 9.3.11.2 Smell/olfactory and taste marks

Smell/olfactory or taste marks are currently not acceptable. This is because the representation must be clear, precise, self-contained, easily accessible, intelligible, durable and objective ([Article 3\(1\) EUTMIR](#)), and the current state of technology does not allow these types of marks to be represented in such way. Furthermore, the EUTMIR does not recognise the submission of samples or specimens as suitable representation. A mark description cannot replace the representation, because a description of a smell or taste is neither clear, precise nor objective (12/12/2002, [C-273/00](#), Sieckmann, EU:C:2002:748, § 69-73; 04/08/2003, [R 120/2001-2](#), THE TASTE OF ARTIFICIAL STRAWBERRY FLAVOUR (gust.)). Therefore, any application for an olfactory or taste mark will not be treated as an application for an EUTM ('deemed not filed') by the Office since it would not comply with the requirements for obtaining a filing date.

### 9.3.11.3 Tactile marks

Tactile marks are currently not acceptable. These are marks where protection is sought for the tactile effect of a certain material or texture, for instance indications in braille alphabet or the specific surface of an object. However, taking into account the requirement under [Article 4 EUTMR](#) that the trade mark must be represented on the register in a manner that enables the competent authorities and the public to determine the clear and precise subject matter of the protection afforded to its proprietor, it is not possible with currently available technology to deduce the 'tactile feeling' claimed with certainty from the existing formats of representation (27/05/2015, [R 2588/2014-2](#),



EMBOSSSED PATTERN ON A SMOOTH BOTTLE SURFACE (al.)). Furthermore, the EUTMIR does not recognise the submission of samples or specimens as suitable representation. Therefore, any application for a tactile mark will not be treated as an application for an EUTM ('deemed not filed') by the Office since it would not comply with the requirements for obtaining a filing date.

### 9.3.12 Correction of mark type

#### 9.3.12.1 General rules

If the mark type indicated in the application contradicts the representation submitted, or if no mark type is given, **and it is obvious** from the EUTMIR which mark type the applicant intended to apply for, the Office will correct the mark type and inform the applicant, giving a 2-month time limit for observations. If there is no response, the correction made by the Office is considered accepted by the applicant. If the applicant disagrees with the amendment, the Office will restore the original mark type indicated; however, the application may then be rejected if the subject matter for which protection as a trade mark is sought is not clear and precise.

Likewise, if the mark type indicated contradicts the representation submitted, or if no mark type is given, **and it is not obvious** which mark type the applicant intended to apply for, a deficiency will be issued and a time limit of 2 months set to remedy the deficiency. If the deficiency is not remedied, the EUTM application will be refused.

The Office cannot accept any request for the mark type of a mark with a filing date before 01/10/2017 to be changed to one of the new mark types defined as of that date in the EUTMIR ([Article 39\(2\)\(a\) EUTMIR](#)).

#### 9.3.12.2 Examples of recurring mark type deficiencies

##### 9.3.12.2.1 Word marks

Where the mark type chosen is 'word', but the mark is actually a 'figurative' mark, such as in the examples in [paragraph 9.2](#) (representation on several lines, stylised font, etc.), the Office will correct the mark type and update the figurative image in the system. The Office will send a letter to the applicant, informing them of the amendment and setting a 2-month time limit for observations. If the applicant does not reply within the time limit, the amendment will be deemed to have been accepted. If the applicant files observations objecting to the amendment, and the Office disagrees with the observations, the mark type will be changed back to 'word' mark, but the application will be rejected.

##### 9.3.12.2.2 Figurative marks

If no mark type has been indicated at all and the mark is clearly figurative in accordance with the examples given above, the mark type is inserted by the Office and the applicant is informed accordingly.

Sometimes 'figurative' marks in colour are erroneously filed as 'colour marks'. Furthermore, the differences in typology of the miscellaneous marks within the EU Member States may lead to a mark type deficiency, in particular with regard to marks combining a word and a figurative element. In such cases, the Office will correct the mark type to 'figurative' and inform the applicant, setting a 2-month time limit for observations.



#### Example 1

A **figurative** mark applied for as a **colour** mark.

The Office will change the mark type from **colour** to **figurative** and send a letter confirming the amendment. If the applicant disagrees, they may submit observations. If the Office disagrees with the observations, it will restore the original indication of mark type, but the application will then be rejected. If, however, there is no response within the time limit, the change of mark type will be considered as accepted and the application will proceed.

#### Example 2

The following marks were applied for as mark type 'other'.

EUTM No 9 328 121	
EUTM No 9 323 346	

When the applicant has chosen the mark type 'other', instead of ticking 'figurative', and has added, in the explanatory field of the 'other mark', terms like 'text and logo', 'marque semi-figurative', 'marca mixta', 'Wort-Bild-Marke', or even 'colour' (because its mark contains elements in colour), but the mark applied for is clearly a figurative trade mark as defined above, the Office will change the mark type from **other** to **figurative** and send a letter to the applicant, informing them of the amendment and giving 2 months for observations to be filed. If the applicant does not reply within the 2-month time limit, the change of mark type will be deemed to have been accepted and the application will proceed. If the applicant files observations objecting to the amendment, and the Office disagrees with the observations, the Office will restore the original indication of mark type, but the application will then be rejected.

#### Example 3

The applicant chose the mark type 'shape' when applying for the following mark.

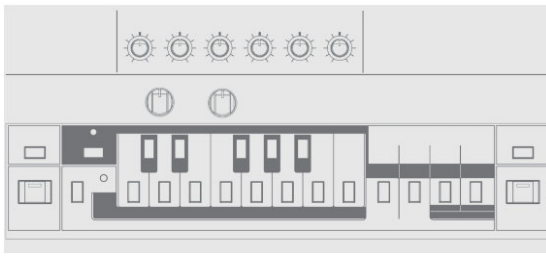
<p>EUTM No 18 016 159</p>	
---------------------------	--

According to [Article 3\(3\)\(c\) EUTMIR](#), a shape mark is a mark consisting of a three-dimensional shape, including containers, packaging, the product itself or their appearance. In the absence of any three-dimensional effect, the Office categorised the mark as figurative and informed the applicant thereof.

9.3.12.2.3 Position marks

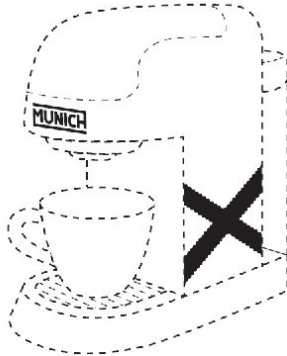
Filed as a figurative mark	Representation of sign
<p>EUTM No 17 912 403</p> <p>The representation of the sign and in particular the use of dotted lines to outline the coffee machine together with the description provided indicating that the image of the coffee machine was not part of the mark itself, altogether led the Office to consider that there was a misalignment between the representation, the type and the description of the mark. The Office corrected the mark to a position mark, having previously informed the applicant.</p>	

9.3.12.2.4 Pattern marks

Filed as a figurative mark	Representation of sign
<p>EUTM No 17 418 121</p> <p>The applicant accepted the Office's proposal to change the mark type to 'pattern mark'.</p>	

## 10 Series marks

Unlike some national systems, the EUTMR does not allow for series/serial marks. When an applicant wants protection for the different versions of a trade mark, a separate EUTM application must be filed for each version.

For more information on applications filed with more than one mark representation in one JPEG or on one A4 sheet, such as series / serial marks, and filing date requirements, see [paragraph 4.14, Representation of the mark](#).

## 11 Priority

Articles [34](#), [36](#) and [41](#) EUTMR

[Article 4 EUTMIR](#)

Decision [EX-17-3](#) of the Executive Director of the Office of 18/09/2017 concerning the formal requirements of a priority claim for a European Union trade mark or a seniority claim for a European Union trade mark or a designation of the European Union under the Madrid Protocol

The effect of the right of priority is that the date of priority will count as the date of filing of the European Union trade mark application for the purposes of establishing which rights take precedence in *inter partes* proceedings.

The principles of priority were first laid down in the Paris Convention for the Protection of Industrial Property of 20/03/1883, which has been revised several times and was last amended in 1979. Article 4 of this Convention — with regard to trade marks — corresponds to [Article 34 EUTMR](#).

A priority claim of a previous EUTM is acceptable if that EUTM was granted a filing date. A priority claim of an international registration is not acceptable. This is because the principle of first filing applies ([Article 34\(4\) EUTMR](#) — see [paragraph 11.2.1](#)), and the priority claim can only be based on the relevant basic mark.

The applicant may claim the priority of one or more previous trade mark applications, namely a national (or Benelux) application filed in or for a state party to the Paris Convention, a Member of the WTO, or a state for which the Commission has confirmed reciprocity, or an EUTM application. See [paragraph 11.2.1](#), 'Principle of first filing', for information on applications that claim the priority of more than one earlier application.

Any filing that is equivalent to a regular national filing under the domestic law applicable to it will be recognised as giving rise to the right of priority.

It is possible to claim both priority and seniority based on the same prior application/ registration, provided that the requirements are met.

## 11.1 Formal requirements

[Article 35 EUTMR](#) lays down the formal requirements for priority claims. At the examination stage, the Office will only examine whether all **formal requirements** are met.

The formal requirements are:

- priority claim filed together with the EUTM application;
- number, date and country of the previous application;
- availability of official online sources to verify the priority data, or submission of priority documents and translations, where applicable.

### 11.1.1 Claiming priority

Priority may be claimed together with the EUTM application or in a separate communication filed on the same date as the EUTM application.

The file number, together with the date and country, of the previous application must be indicated when claiming priority.

The claim may be implicit, such that the submission of the priority documents with the application or in a separate communication filed on the same date as the EUTM application will be construed as a declaration of priority. Simple filing receipts containing the **country, number** and **date** of the earlier application(s) are accepted.

It must be taken into account that the Office will publish the priority claim 'as filed', meaning that the Office will not confirm the validity of the priority claim.

### 11.1.2 Priority documents

The documentation in support of the priority claim must be filed within 3 months of the filing date. However, following Decision [EX-17-3](#) of the Executive Director of the Office, if the priority documents are not submitted with the application or are not complete, the Office will check whether the relevant information, namely the number, filing date and country, the name of the applicant or proprietor, the representation of the mark and the list of goods and services of the earlier trade mark application in respect of which priority is claimed, is available on the website of the central industrial property office of the country of first filing.

Only in the case that the information of the priority claim cannot be found on such website, the Office will send a letter to the applicant, requesting that the priority documents, that is to say, a copy of the previous application, be submitted. The applicant will be given a time limit of 2 months to remedy the deficiency; as a rule, this time limit will not be extended. Usually, the deficiency letter will be issued before expiry of the original time limit for submitting the priority documents (3 months from the filing date of the EUTM application). In this case, the 2-month deficiency time limit will be

calculated from the date of expiry of the original time limit for the submission of the priority documents.

Certified copies are not necessary. However, simple filing receipts that do not contain all the necessary information for examining the priority claim (e.g. containing only class numbers for the goods and services of the prior application and not the full text version indicating all the goods and services) are not acceptable.

If the mark concerned is in colour, colour photocopies must be submitted for the earlier application(s).

### 11.1.3 Language of previous application

If the priority information available on an office website or the priority documents submitted are not in one of the languages of the European Union, the Office will invite the applicant to file a translation into the first or second language of the EUTM application. The translation should cover all the relevant information mentioned under [paragraph 11.1](#) and [11.2](#).

### 11.1.4 Formal priority requirements not satisfied

If the priority claim is filed after the date of application of the EUTM and/or the priority claim or the priority documents fail to satisfy any of the other formal requirements, the applicant will be invited to remedy the deficiency or make observations within the time limit set by the Office.

If there is no response, or if the deficiencies are not remedied within the time limit set, the Office will notify the loss of rights to the applicant and set a 2-month time limit during which the applicant may request a formal, appealable decision on the loss of rights.

If the applicant formally requests a decision within the time limit, the Office will issue a formal decision on the loss of rights.

## 11.2 Substantive requirements for priority claims

The requirements that refer to the substance of the priority claims are covered by [Article 34 EUTMR](#) and relate to the 6-month period, the condition of a first regular filing and triple identity (same owner, same mark and same goods and services).

The substantive requirements under [Article 34 EUTMR](#) will not be examined at the filing stage but during *inter partes* proceedings, where necessary, and will be restricted to the extent of the *inter partes* proceedings.

The substantive requirements of the priority claim will be examined when the outcome of the opposition or cancellation case depends on whether priority was validly claimed, which is in the following situations.

- In order to assess whether the trade mark on which the opposition (or invalidity request) is based is an ‘earlier mark’ or ‘earlier right’ within the meaning of [Article 8\(2\) to \(4\) and \(6\) EUTMR](#). Determining the validity of the priority claim of the contested EUTM or earlier mark will be necessary when the relevant date of the earlier mark (its filing date or priority date) falls between the date of the claimed priority and the date of the filing of the contested EUTM. This will be assessed when the admissibility of the action based on that earlier right is determined.
- In order to assess the admissibility of the request for proof of use (whether the earlier mark is subject to use or not). The assessment of the priority claim of the contested EUTM is necessary for determining the admissibility of the request for proof of use in *inter partes* proceedings when the 5 years from registration of the earlier right falls between the priority date of the contested mark and its filing date. Such examination does not preclude the re-assessment of substantive requirements in respect of the priority claim at the decision-taking stage if this is relevant for the outcome of the case.
- In order to determine the period of use. It will always be necessary to examine priority in order to calculate the 5-year period to which proof of use must relate.

### 11.2.1 Principle of first filing

The ‘convention priority’ right is a right limited in time, which is triggered by the first regular filing of a trade mark. A regular national filing is any filing that is ‘adequate to establish the date on which the application was filed in the country concerned, whatever the subsequent fate of the application’ (Article 4A(3) Paris Convention). It may be claimed during the 6 months following the first filing, provided the country of first filing was a party to the Paris Convention or to the Agreement establishing the World Trade Organisation (WTO), or a country with a reciprocity agreement (see [Article 34\(5\) to \(7\) EUTMR](#) — publication on reciprocity by the Commission).

The states and other entities mentioned below, *inter alia*, are not members of any of the relevant conventions. Nor do they benefit from reciprocity agreements. Therefore, priority claims based on filings in these countries will be **rejected**.

Independent states (not party to PC, WTO or reciprocity agreement):

- Afghanistan (AF)
- Aruba (AW)
- Cook Islands (CK)
- Eritrea (ER)
- Ethiopia (ET)
- Kiribati (KI)
- Marshall Islands (MH)
- Micronesia (FM)
- Nauru (NR)
- Palau (PW)
- Somalia (SO)
- Tuvalu (TV).

Other entities (not party to PC, WTO or reciprocity agreement):

- Abkhazia (GE-AB)
- American Samoa (AS)
- Anguilla (AI)
- Bermuda (BM)
- Cayman Islands (KY)
- Falkland Islands (FK)
- Guernsey (GG)
- Isle of Man (IM)
- Jersey (JE)
- Montserrat (MS)
- Pitcairn Islands (PN)
- Saint Helena (SH)
- Turks and Caicos Islands (TC)
- British Virgin Islands (VG).

The previous application must be a first regular filing and cannot be of the same date as the EUTM application. The Office will therefore check (i) that there was no priority claim made on the prior application(s) and (ii) that no seniority claim made for the EUTM application relates to a mark that has a filing date prior to that of the application(s) from which priority is claimed.

The Office will also check that the EUTM application was filed no later than 6 months following the date of filing of the earlier application(s).

Where priority of more than one earlier application is claimed, the goods and/or services covered by each of those applications must be different in order for the principle of first filing to be met. For examples, please see [paragraph 11.3.1](#).

### 11.2.2 Triple identity

The Office will check that the EUTM application and the priority documents contain the same mark, refer to the same applicant and have all relevant goods or services in common.

#### 11.2.2.1 Identity of the marks

The Office and a number of trade mark offices of the European Union have agreed on a common practice under the European Trade Mark and Design Network concerning the identity of trade marks filed in black and white and/or greyscale as compared with those filed in colour (Common Communication on the Common Practice on Scope of Protection of Black and White ('B&W') Marks ([CP4](#))). The offices consider that the Common Practice Note issued is a reflection of the current case-law that a trade mark filed in black and white and/or greyscale is, for the purposes of assessing priority, not identical to the same mark filed in colour unless the differences in colour or shades of grey are so insignificant that they could go unnoticed by the average consumer (19/01/2012, [T-103/11](#), Justing, EU:T:2012:19, § 24; 20/02/2013, [T-378/11](#), Medinet,



EU:T:2013:83; 09/04/2014, [T-623/11](#), Milanówek cream fudge, EU:T:2014:199). **An insignificant difference between two marks is one that a reasonably observant consumer will perceive only upon examining the marks side by side.**

The principle described above applies to all cases where marks are compared for the purpose of priority claims. In relation to word marks, the mark applied for will in most cases be deemed to be the same as the earlier mark where there is a difference only in respect of typeface or where one mark is in upper case letters and the other in lower case. Furthermore, a difference in punctuation or the addition of a space separating two words will not usually prevent the marks from having identity (09/10/2012, [R 797/2012-2](#), WATER JEL, 15/07/1998, [R 10/1998-2](#), THINKPAD).

The Office will also check the mark type of the earlier application, because a different mark type may mean that the EUTM application is different from the earlier mark. For example, a figurative mark is not the same as a shape mark or a position mark. However, a word mark can be considered to be the same as a figurative mark if standard type is used in the figurative mark (see the examples in [paragraph 11.3.2](#)).

The Office and a number of trade mark offices of the European Union, in the framework of the European Union Intellectual Property Network, have agreed on a Common Practice ([CP11](#)) in relation to the examination of formal requirements and grounds for refusal of new types of marks (sound, motion, multimedia and hologram marks).

Following CP11, two trade marks will be considered as identical for the purpose of examination of priority claims if the subject matter of protection and the trade mark are the same, regardless of the format of the representation, for example, a sound mark first filed in musical notations and the second filing in electronic format. Additionally, priority may be accepted when the second filing is a different type of trade mark but has identical subject matter. Concrete examples of examining priority claims of new types of marks can be found in the Common Communication on New Types of Marks: Examination of Formal Requirements and Grounds for Refusal ([CP11](#)).

Regarding the kinds of marks (individual, collective and certification) that can be indicated in an application and taking into account the disparities of national legislations, the Office will disregard a priority claim between different kinds of mark **only** where there is an incompatibility between the kinds of mark. Whereas compatibility might exist between collective and certification marks, compatibility is excluded between individual marks and collective/certification marks.

#### 11.2.2.2 Identity of the goods and services

The Office will check that all goods or services of the EUTM application that are relevant in *inter partes* proceedings are covered by the goods and services of the first filing.

### 11.2.2.3 Identity of the owner

Priority can be claimed by the applicant of the first application or its successor in title. In the latter case, the transfer must have taken place prior to the filing date of the EUTM application, and documentation to this effect must be submitted. The right of priority as such may be transferred independently of whether or not the first application as a whole is transferred. Priority can therefore be accepted even if the owners of the EUTM application and the earlier right are different, provided that evidence of the assignment of the priority right is produced; in this case, the execution date of the assignment must be prior to the filing date of the EUTM application.

Subsidiary or associated companies of the applicant are not considered to be the same as the EUTM applicant.

Where the applicant of the first application states that it has changed its name since the first filing, and files the EUTM application under its new name, the applicant is considered to be the same person.

For the distinction between a change of name and a transfer, see [the Guidelines, Part E, Register Operations, Section 3, EUTMs and RCDs as Objects of Property, Chapter 1, Transfer](#).

### 11.2.3 Substantive priority requirements not satisfied

If the priority claim does not satisfy any of the above substantive requirements, the applicant will be invited to make observations within the time limit set by the Office.

If the priority right could not be proved or appeared to be unacceptable, the priority right would be refused. The outcome of the full examination would be reflected in the final decision on the opposition or cancellation proceedings.

## 11.3 Examples of priority claims

### 11.3.1 First filing

In the example below, the priority claim of more than one earlier application is acceptable because the goods covered by each of those earlier applications are different and therefore the principle of first filing is met.

First filing	Country	Goods/services	EUTM filed	Goods/services
6 April	Italy	Perfumes	11 September	Perfumes, bags, clothing
9 May	Germany	Bags		
23 May	Spain	Clothing		

In the example below, the two earlier trade mark applications were filed for exactly the same goods. The priority claim based on the Greek application has to be rejected since the trade mark was applied for in Spain first; thus the Greek application is no longer a first filing.

First filing	Country	Goods/services	EUTM filed	Goods/services
6 April	Spain	<i>Cheese, wine</i>	4 October	<i>Cheese, wine</i>
7 April	Greece	<i>Cheese, wine</i>		

In the example below, priority cannot be claimed from a first filing in Somalia, since Somalia is not a party to the Paris Convention or the World Trade Organisation and has no reciprocity agreement confirmed by the EU Commission. Therefore, the first filing in Italy is the one considered for the priority claim; the other filing cannot be taken into consideration.









First filing	Country	Goods/services	EUTM filed	Goods/services
5 April	Somalia	<i>Cars, T-shirts</i>	2 October	<i>Cars, T-shirts</i>
7 July	Italy	<i>Cars, T-shirts</i>		







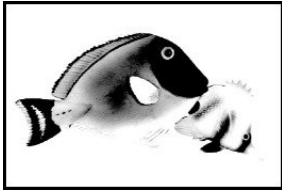
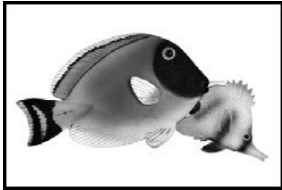



### 11.3.2 Comparison of the marks



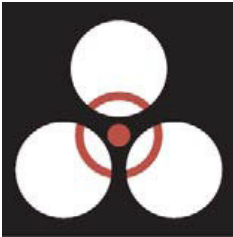

The examples below cover acceptable and unacceptable priority claims for formalities' purposes where the identity of the marks is assessed. As explained under [paragraph 11.2.2.1](#), only 'insignificant differences' between the EUTM application and the mark invoked under the priority claim will be accepted, that is to say, differences that are not considered to alter the meaning, pronunciation and visual impact of the marks.

The [Common Communication on New Types of Marks: Examination of Formal Requirements and Grounds for Refusal \(CP11\)](#) provides further examples of priorities of sound, motion, multimedia and hologram marks.

Examples of signs considered identical	
EUTM application (word mark) EVAL	Priority claim (word mark) <b>EVAL</b>
EUTM application (word mark) Luna	Priority claim (word mark) <i>Luna</i>

Examples of signs considered identical	
<p>EUTM application (figurative mark)</p> 	<p>Priority claim (figurative mark)</p> 
<p>EUTM application (figurative mark)</p> 	<p>Priority claim (figurative mark)</p> 
<p>EUTM application (figurative mark)</p> 	<p>Priority claim (figurative mark)</p> 
<p>EUTM application (figurative mark)</p> 	<p>Priority claim (figurative mark)</p> 
<p>EUTM application (figurative mark)</p> 	<p>Priority claim (figurative mark)</p> 



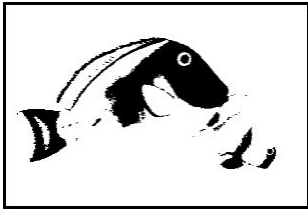
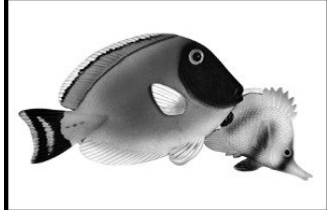



Examples of non-identical signs	
<p>EUTM application (colour mark)</p> 	<p>Priority claim (colour mark)</p> 
<p>EUTM application (word mark)</p> <p>Chocolate Dream</p>	<p>Priority claim (word mark)</p> <p>Chocalate Dream</p>
<p>EUTM application (figurative mark)</p> 	<p>Priority claim (figurative mark)</p> 
<p>EUTM application (figurative mark)</p> 	<p>Priority claim (figurative mark)</p> 
<p>EUTM application (figurative mark)</p> 	<p>Priority claim (figurative mark)</p> 
<p>EUTM application (figurative mark)</p> 	<p>Priority claim (figurative mark)</p> 

Examples of non-identical signs	
<p>EUTM application (figurative mark)</p> 	<p>Priority claim (figurative mark)</p> 
<p>EUTM application (figurative mark)</p> 	<p>Priority claim (figurative mark)</p> 
<p>EUTM application (figurative mark)</p> 	<p>Priority claim (figurative mark)</p> 

Further examples for word marks			
First trade mark	EUTM application	considered identical	considered not identical
Word mark Percy & Reed	Word mark Percy + Reed		X
Word mark Percy & Reed	Word mark Percy and Reed		X
Word mark Percy & Reed	Word mark <b>Percy &amp; Reed</b>	X	
Word mark Percy & Reed	Word mark Percy & REED	X	

Further examples for word marks			
Word mark Percy & Reed	Word mark PERCY & REED	X	
Word mark Percy & Reed	Word mark <i>Percy &amp; Reed</i>	X	
Word mark POPEYE	Word mark POPeYe	X	
Word mark POPEYE	Word mark PopEye	X	
Word mark POPEYE	Word mark POP-EYE	X	
Word mark POPEYE	Word mark POP EYE	X	
Word mark POPEYE®	Word mark POPEYE	X*	
Word mark POPEYE	Word mark POPEYE!?		X
Word mark POPEYE	Word mark POPEYES		X
Word mark <b>POPEYE</b>	Word mark <b>POPEYE·</b>	X	
Word mark JOSÉ RAMÓN	Word mark JOSE RAMON	X	
Word mark SKAL	Word mark SKÅL		X
*The symbols <sup>TM</sup> and <sup>®</sup> are not considered parts of the mark.			

Examples for identity between figurative signs as compared to word marks			
First trade mark	EUTM application	considered identical	considered not identical
Word mark Percy & Reed	Figurative mark Percy & Reed (figurative mark in standard type face)	X	
Word mark Percy & Reed	Figurative mark Percy & Reed (words distributed over several lines)		X
Word mark Percy & Reed	Figurative mark Percy & Reed (colour claim)		X

Further examples for figurative marks			
First trade mark	EUTM application	considered identical	considered not identical
			X
			X
		X*	



Further examples for figurative marks
*The symbols <sup>TM</sup> and <sup>®</sup> are not considered parts of the mark.

### 11.3.3 Comparison of the goods and services

The first example below is the most usual situation: the prior application corresponds fully to the EUTM application.

First filing	Country	Goods and services	EUTM filed	EUTM goods and services
5 April	UK	<i>Hats, shoes</i>	1 October	<i>Hats, shoes</i>

In the next example, both priority claims can be accepted since application number XY 1234 is the first filing with respect to *cars* and application number XY 1235 is the first filing with regard to *airplanes*.

First filing	Country	JP application No	Goods and services	EUTM filed	EUTM goods and services
5 April	Japan	XY 1234	<i>Cars</i>	2 October	<i>Cars, airplanes</i>
5 April	Japan	XY 1235	<i>Airplanes</i>		

In the next example, the priority claim concerns *hats* and *shoes*, which are common to the first filing and the EUTM application. No priority will apply with respect to *bags*.



First filing	Country	Goods and services	EUTM filed	EUTM goods and services
5 April	USA	<i>Cars, hats, shoes</i>	1 October	<i>Hats, shoes, bags</i>

In the last example, priority is claimed for first filings in France, Canada and China. The EUTM application has been filed within 6 months of each of the first filings and the priority claims will be accepted, although the Canadian application does not constitute a first filing for *hats* (as *hats* appear in the French application, which was filed before the Canadian one). Comparing the dates and the lists of goods and services of the three priorities, the priority claims will be accepted.

First filing	Country	Goods and services	EUTM filed	EUTM goods and services
5 April	France	<i>Hats, shoes</i>	5 October	<i>Hats, shoes, cars, beer, wine, telecommunication services</i>
6 April	Canada	<i>Cars, hats, beer</i>		
7 April	China	<i>Wine, telecommunication services</i>		

#### 11.3.4 Priority claims based on series marks

A series of trade marks refers to a number of trade marks that resemble each other in material details and differ only in terms of non-distinctive character. Whereas the EUTMR does not allow for the filing of series marks, some national offices (e.g. the United Kingdom, Australia) do, and such a series of marks filed in one single application can contain numerous very similar marks. When the first filing consists of a series mark, two or more slightly different mark representations will be seen. The priority claim is acceptable with regard to the one reproduction that is identical to that of the mark applied for as an EUTM.

Examples of priority claims based on series marks		
First filing	EUTM	Priority claim acceptable
Series of marks 		Yes
Series of marks Café@Home CAFÉ@HOME Café@Home CAFÉ@HOME	CAFÉ@HOME	Yes

#### 11.3.5 Claiming priority for marks represented in a different format

Issues may arise from the different formal requirements relating to the representation of marks at the various intellectual property offices around the world when claiming priority for, or on the basis of, an EUTM application.

The [Common Communication on New Types of Marks: Examination of Formal Requirements and Grounds for Refusal \(CP11\)](#) provides examples concerning sound, motion, multimedia and hologram marks. For more details, see also paragraph [11.2.2.1 Identity of the marks](#).

#### 11.3.5.1 Claiming the priority of an earlier national filing for an EUTM application

It may happen that an applicant wishing to claim the priority of a previous national filing represented graphically (e.g. by musical notes) files an EUTM application representing the mark in an electronic format (e.g. mp3 for a sound mark). In principle, the different method of representation is not an obstacle for accepting the priority claim so long as the earlier filing represents the same trade mark, albeit in a different format, and provided that the format used to represent the earlier filing is recognised by the Office. In the case of any discrepancy between the subject matter of the representations, the priority will be refused for that reason, not because of the different formats.

Furthermore, some national IP offices do not allow more than four representations to be filed for shape or other marks. If an EUTM application claims the priority of such a first filing, and six (or more, in the case of 'other' marks) depictions/perspectives of the mark are filed with the EUTM application, the marks in question will still be considered identical if the representations of the first filing coincide with part of what was sent for the EUTM application and if the object is undoubtedly the same.

#### 11.3.5.2 Claiming the priority of an earlier EUTM filing for a national application

As regards priority claims on the basis of an EUTM application, applicants should be aware of the possible non-acceptance by a particular national office of the format of representation used for filing with the Office. The Office cannot certify the concordance of the EUTM filing with that of a later national filing represented in a different format.

As regards colour indications, some countries require an indication of colour in writing for claiming priority. For this purpose, applicants may list colours in an optional field of the application form. That indication will not be part of the EUTM application, will not be examined and will not be published or reflected in the Register. Nevertheless, it will be part of the dossier for the purposes of file inspections and the applicant may thus obtain certification of such colour indications as filed.

## 12 Exhibition Priority

[Article 38 EUTMR](#)

[Article 5](#) and [Article 7\(g\) EUTMIR](#)

Exhibition priority entails claiming as a priority date for the EUTM application the date on which the goods or services covered by the EUTM application were displayed at an officially recognised exhibition under the mark as filed. The applicant can claim

exhibition priority within 6 months of the first display. Evidence of the display must be filed.

Like 'convention priority', exhibition priority can be claimed either in the application or subsequent to the filing of the EUTM application but still on the same day. The claim must include the name of the exhibition and the date of first display of the goods or services.

Within 3 months of the date of submitting the declaration of priority, the applicant must submit to the Office a certificate issued at the exhibition by the responsible authority. This certificate must state that the mark was in fact used for the goods or services, and indicate the opening date of the exhibition and, where the first public use did not coincide with the opening date of the exhibition, the date of first public use. The certificate must be accompanied by an identification of the actual use of the mark, duly certified by the authority.

Priority can only be granted where the application for an EUTM is filed within 6 months of the first display at an exhibition recognised for this purpose, namely a world exhibition within the meaning of the Convention Relating to International Exhibitions of 22/11/1928. These exhibitions are very rare and [Article 33 EUTMR](#) does not protect display at other, national, exhibitions. The exhibitions can be found on the website of the Paris *Bureau International des Expositions*: <http://www.bie-paris.org/site/en/>.

As is the case for convention priority, the substantive requirements for exhibition priority will not be examined at the filing stage but during *inter partes* proceedings, where necessary, and will be restricted to the extent of the *inter partes* proceedings (to that effect, see [paragraph 11.2](#)).

The claim may be implicit. Where there is no indication of the claim in the application, the submission of the exhibition priority documents on the same date as the filing date of the EUTM application will be construed as a declaration of priority.

## 13 Seniority

[Article 39 EUTMR](#)

[Article 6](#) and [Article 7\(h\) EUTMR](#)

Decision [EX-17-3](#) of the Executive Director of the Office of 18/09/2017 concerning the formal requirements of a priority claim for a European Union trade mark or a seniority claim for a European Union trade mark or a designation of the European Union under the Madrid Protocol

The proprietor of an earlier trade mark registered in a Member State, including a trade mark registered in the Benelux countries, or registered under international arrangements having effect in a Member State, that applies for an identical trade mark for registration as an EUTM in respect of goods or services that are identical to or contained within those for which the earlier trade mark has been registered, may claim

for the EUTM application the seniority of the earlier trade mark in respect of the Member State in or for which it is registered.

Seniority has the sole effect that, where the proprietor of an EUTM surrenders the earlier trade mark for which seniority has been claimed or allows it to lapse, the proprietor will be deemed to continue to have the same rights as it would have had if the earlier trade mark had continued to be registered.

This means that the EUTM application represents a consolidation of earlier national registrations. If an applicant claims seniority for one or more earlier registered national marks and the seniority claim is accepted, the applicant may decide not to renew the earlier national registration(s) but still be in the same position as if the earlier trade mark(s) had continued to be registered in those Member States.

Seniority under [Article 39 EUTMR](#) must be claimed with the application or within 2 months of the filing date of the EUTM application. The documents in support of the claim must be submitted within 3 months of the claim. The seniority claim may be implicit. If the applicant sends only the documents concerning the earlier registrations within 2 months of the filing date of the EUTM application, the Office will construe this as a seniority claim concerning these earlier registrations.

Seniority may be claimed not only for earlier national registrations, but also for an international registration with effect in an EU country. No seniority claim is possible, however, for an earlier EUTM registration or local registrations, even if the territory is part of the European Union (e.g. Gibraltar).

### **13.1 Harmonised seniority information**

In order to be able to manage seniorities properly, it is recommended that all seniority entries in the system have the same format as that used in the databases of the national offices.

### **13.2 Seniority examination**

A valid claim must contain the following indications:

1. the Member State or Member States of the EU in or for which the earlier mark for which seniority has been claimed is registered;
2. the filing date of the relevant registration;
3. the number of the relevant registration;
4. the goods or services for which the mark is registered.

The proprietor is not required to file a copy of the registration if the required information is available online. If the copy of the registration is not submitted, the Office will first search for the necessary information on the relevant website and only if the information is not available there will send the proprietor a deficiency letter to request a copy. The copy of the relevant registration must consist of a copy (a simple photocopy will suffice) of the registration and/or renewal certificate or extract from the Register, or an extract

from the relevant national gazette, or an extract or printout from an official database. Extracts and printouts from private databases are not accepted. Examples of extracts that are not accepted are DEMAS, MARQUESA, COMPUSERVE, THOMSON, OLIVIA, PATLINK, COMPUMARK and SAEGIS.

Seniority may only be claimed for an earlier **registration**, not for an earlier application.

The Office must check both that the earlier mark was registered at the time the EUTM application was filed and that the earlier registration had not lapsed at the time the claim was made.

If the earlier registration had lapsed at the time the claim was made, seniority cannot be claimed, even if the relevant national trade mark law provides for a 6-month 'grace' period for renewal. While some national legislation allows for a grace period, if the renewal is not paid, the mark is considered to be not registered from the day it was due for renewal. Therefore, the claim is not acceptable, unless the applicant shows that it has renewed the earlier registration(s).

The seniority claimed for the EUTM will lapse if the earlier trade mark in respect of which seniority is claimed is declared to be invalid or revoked. If the earlier trade mark has been revoked, the seniority will lapse, provided that the revocation took effect prior to the filing date or priority date of the European Union trade mark ([Article 39\(4\) EUTMR](#)).

In the context of an **enlargement** of the EU, the following details have to be borne in mind. Where a national trade mark of, or an international registration with effect in, a new Member State was registered before the seniority claim is made, **seniority may be claimed even though the priority, filing or registration date of the EUTM to which the seniority claim relates predates the priority, filing or registration date of the national mark/IR with effect in the new Member State**. This is because the EUTM at issue only has effect in the new Member State from the date of accession. The national trade mark/IR with effect in the new Member State for which seniority is claimed is therefore 'earlier' than the EUTM within the sense of [Article 39 EUTMR](#), **provided** that the national trade mark/IR with effect in the new Member State enjoys a priority, filing or registration date **prior to the accession date**.

Examples of acceptable seniority claims for new Member States			
EUTM No	Filing date	Seniority claim country	Filing date of earlier right
2 094 860 TESTOCAPS	20/02/2001	Cyprus	28/02/2001
2 417 723 PEGINTRON	19/10/2001	Hungary	08/11/2001
352 039 REDIPEN	02/04/1996	Bulgaria	30/04/1996
7 073 307 HydroTac	17/07/2008	Croatia	13/10/2009

**Explanation:** In all cases, although the filing date of the EUTM application is earlier than the filing date of the mark for which seniority is claimed, as all countries concerned acceded to the European Union after the filing date of the EUTM application (i.e. on 01/05/2004 for Cyprus and Hungary, on 01/01/2007 for Bulgaria and on 01/07/2013 for Croatia), and it is from that date that the EUTM application has protection in those Member States, seniority can be claimed for the national marks filed in those Member States prior to their dates of accession.

If the claim to seniority is in order, the Office will accept it and — once the EUTM application has been registered — inform the relevant central industrial property office(s) of the Member State(s) concerned.

Seniority can also be claimed after the EUTM is registered under [Article 40 EUTMR](#). For further details, see [the Guidelines, Part E, Register Operations, Section 1, Changes in a Registration](#).

### **13.3 Identity of the marks**

Examination of seniority claims is limited to the formal requirements and to the identity of the marks.

As regards the triple-identity requirement (same owner, same mark, same goods and services), it is for the applicant to ensure that these requirements are met. The Office will examine only whether the marks are the same.

The comparison of the mark representations for the purposes of seniority claims is the same as that for priority claims detailed in [paragraph 11.2.2.1](#).

### **13.4 Goods and services**

Applicants may claim seniority for only some of the goods and services of the earlier registration(s). Effectively, the claim to seniority will be valid to the extent that there is an overlap between the goods and services of the EUTM application and the registration relied on. The applicant is not required to specify those goods and services, but may simply claim ‘seniority for all the goods that are found in the earlier mark to the extent that they are also found in the EUTM application’ (generic seniority claim).



### **13.5 Treatment of seniority examination deficiencies**

If the claim is not valid, the earlier registration is not identical to the EUTM application, the seniority is claimed out of time (i.e. more than 2 months after the filing of the EUTM application) or the seniority documents are not acceptable and the relevant information cannot be found online, the Office will issue a deficiency letter.

If the deficiencies are not remedied within the time limit set by the Office, the applicant will be notified in writing of the loss of rights. At the same time the applicant will be informed that it can ask for a formal decision within 2 months of the notification.





If the applicant formally requests a decision within the time limit, the Office will issue a formal decision on the rejection of the seniority claim.





### 13.6 Examples of seniority claims

Examples of signs considered identical	
EUTM application (word mark) CELOTAPE	Seniority claim (word mark) Celotape
EUTM application (word mark) Daisys Gingerbread	Seniority claim (word mark) Daisy's Gingerbread
EUTM registration (figurative mark) 	Seniority claim (figurative mark) 



<p>EUTM application (word mark) CULTILENE</p>	<p>Seniority claim (series of marks)</p> <p>CULTILENE</p> 
---	--

Examples of signs considered non-identical	
<p>EUTM application No 9 817 735 (figurative mark)</p> 	<p>Seniority Claim (figurative mark)</p> 
<p>EUTM application (word mark) Great changes in education PLC</p>	<p>Seniority claim (word mark) Grate changes in education PLC</p>
<p>EUTM application No 8 786 485 (figurative mark)</p> 	<p>Seniority claim (figurative mark)</p> 

Examples of signs considered non-identical	
EUTM application No 14 061 881 (figurative mark) 	Seniority claim (figurative mark) 
EUTM application No 18 128 227 (figurative mark) 	Seniority claim (combined mark) 

For examples of identical and non-identical signs when claiming priority and which would also be considered identical or non-identical signs regarding seniority claims, see [paragraph 11.3.2](#).

## 14 Transformation

Transformation is a legal feature introduced in the Madrid Protocol to soften the consequences of the 5-year dependency period between the international registration and the basic mark. In the event that the international registration designating the EU is cancelled at the request of the office of origin in respect of all or some of the goods and services, the holder of the international registration may file an EUTM application for the registration of the same mark in relation to the goods and services that have been cancelled. That application will be treated as if it had been filed on the date of the international registration or the subsequent designation of the EU and will enjoy the same priority, if any. For more details on transformation, see [the Guidelines, Part M, International Marks](#).

## 15 Amendments to the EUTM Application

[Article 49 EUTMR](#)

[Article 11 EUTMDR](#)

The applicant may at any time withdraw its EUTM application or restrict the list of goods and services covered by it. Other changes are only contemplated to correct certain mistakes.

Any change requested on the same day of filing of the EUTM application will be accepted.

This part of the Guidelines will only describe Office practice concerning amendments to the mark representation. For further details on withdrawal or restrictions, see [the Guidelines, Part B, Examination, Section 1, Proceedings](#) and, for restrictions specifically, [the Guidelines, Part B, Examination, Section 3, Classification](#).

Once an application has been filed in colour, it is not possible to amend it to one that is not in colour (25/08/2010, [R 1270/2010-4](#), Prüfköpfe (3D)). The applicant's only option is to file a new application.

### 15.1 Amendments to the representation of the mark

The Office's practice on amendments to the mark representation is very strict. The two conditions for allowing a change to a mark once filed are **cumulative**:

- the mistake must be obvious, **and**;
- the amendment must not substantially change the mark as filed.



Even if the amendment is not a substantial one, if the mistake is not obvious, the Office will not accept the amendment.

In cases where the desired positioning of a mark is not obvious, the representation of the mark must indicate the correct position by adding the word 'top' to the reproduction of the sign.

In cases where the desired positioning of a mark is not obvious (e.g. a mark containing a verbal element is filed in a vertical position) and there is no indication of the intended positioning in the application, the applicant will be allowed to amend the position of the mark upon request. This is because the unusual positioning of the mark will be considered an obvious mistake.



If a priority or seniority claim is filed at the same time as the EUTM application, an obvious error may be proven by comparing the 'correct' mark in the claim with the mark on the EUTM application. However, if the priority or seniority claim is filed after the EUTM application, no evidence from these claims can be taken into account.

If the mistake is obvious, the mark must then be assessed according to the next criterion, namely whether the requested change substantially alters the mark as filed.

<b>Example of an acceptable amendment (for formalities' purposes)</b>	
EUTM No 546 010 Mark filed as 'TOPFLOW'	Proposed change 'TOP FLOW'
In the application form, the applicant claimed priority for the mark 'TOP FLOW', meaning that it was obvious that a typographical error had been made. The amendment was not considered to be a substantial alteration of the mark as the addition of a space between the words 'TOP' and 'FLOW' does not alter the meaning and pronunciation of the mark, and the visual impact of the amendment is low (05/08/2002, <a href="#">R 851/1999-2</a> , TOPFLOW).	
EUTM No 18 437 494 EUTM as filed	Proposed change
	
The applicant filed the mark representation without noticing the small mouse cursor on the top right side. They submitted a new representation requesting the substitution and claiming that the mouse cursor did not form part of the mark. The Office accepted the change considering it an obvious error that did not change the mark substantially.	

<b>Examples of unacceptable amendments (for formalities' purposes)</b>	
EUTM No 321 109 Mark filed as 'RANIER'	Proposed change 'RAINIER'
This change is not allowed as the correction shows the addition of another letter 'I', which would substantially change the mark as filed. 'RANIER' and 'RAINIER' are two different words.	
EUTM No 6 013 668 Mark filed as 'ELECTROLITIC BOLUS'	Proposed change 'ELECTROLITYC BOLUS'
This change is not allowed as the correct English spelling for this word is 'ELECTROLYTIC'. Consequently, the mark as filed had one erroneous letter whilst the amendment proposal would have two erroneous letters. This would substantially alter the mark and is therefore unacceptable.	

In the case of figurative elements, only elements of minor importance can be amended; this will be dealt with on a case-by-case basis. Giving a 'fresh look' to a figurative mark (which is a frequent practice in the industry in order to adapt the appearance of a figurative mark to current design and fashion trends from time to time) is not allowed.

Examples of unacceptable amendments (for formalities' purposes)	
<p>EUTM No 6 538 524</p> <p>EUTM as filed</p> 	<p>Proposed change</p> 
<p>The applicant filed a priority claim with the EUTM application, which showed that the first filing consisted of a single representation of the mark. In addition, the EUTM application contained a mark description that described the single representation and not the two images that had been filed. Therefore, the mistake was considered to be obvious. The amendment request was, however, rejected as the amendment would substantially change the mark from that which was filed.</p>	

Notwithstanding the aforementioned principles and examples, any alteration of the mark that would be allowable after registration will also be allowable in respect of an EUTM application.

Regarding alterations of a registered EUTM, please refer to the Guidelines, [Part E, Register operations, Section 1, Changes in a registration](#).

## 16 Conversion

Articles [139\(1\)](#) and [140\(1\)](#) EUTMR

[Article 22\(f\) EUTMIR](#)

The applicant for an EUTM application or proprietor of a registered EUTM may request the conversion of its EUTM application or registered EUTM. For more information on conversion see [the Guidelines, Part E, Register Operations, Section 2, Conversion](#).

***GUIDELINES FOR EXAMINATION OF  
EUROPEAN UNION TRADE MARKS***

***EUROPEAN UNION  
INTELLECTUAL PROPERTY OFFICE  
(EUIPO)***

***Part B***

***Examination***

***Section 3***

***Classification***

## Table of Contents

<b>1 Introduction.....</b>	<b>284</b>
<b>2 The Nice Classification.....</b>	<b>285</b>
<b>3 Other Administrative Tools for Classification Purposes.....</b>	<b>286</b>
<b>4 Building a List of Goods and Services.....</b>	<b>286</b>
<b>4.1 Choosing adequate scope of protection .....</b>	<b>286</b>
<b>4.2 Clarity and precision.....</b>	<b>287</b>
4.2.1 General principles.....	287
4.2.2 Influence of classification on the scope of protection.....	287
4.2.3 Use of expressions (e.g. 'namely', 'in particular') to determine the scope of the list of goods/services.....	289
4.2.4 Use of the term 'and/or'.....	290
4.2.5 Punctuation.....	290
4.2.6 Inclusion of abbreviations and acronyms in lists of goods and services.....	291
<b>4.3 Terms lacking clarity and precision.....</b>	<b>292</b>
4.3.1 General indications of Nice Classification class headings lacking clarity and precision.....	292
4.3.2 Other terms lacking clarity and precision.....	297
4.3.3 The claim for all goods/services in a class or all goods/services of the alphabetical list in a class.....	298
4.3.4 Reference to other classes within the list.....	298
4.3.5 Trade marks in lists of goods/services.....	299
4.3.6 Geographical indications in lists of goods and services.....	299
4.3.7 Inclusion of the terms <i>parts and fittings</i> ; <i>components</i> and <i>accessories</i> in lists of goods and services.....	300
4.3.8 Use of indefinite qualifiers.....	300
<b>5 Examination Procedure.....</b>	<b>301</b>
<b>5.1 Parallel applications.....</b>	<b>301</b>
<b>5.2 Objections.....</b>	<b>301</b>
<b>5.3 Restriction and amendment of a list of goods and services.....</b>	<b>303</b>
5.3.1 Rules governing restrictions and amendments.....	303
5.3.2 Wording of restrictions.....	304
5.3.2.1 References to trade marks.....	306
5.3.2.2 Territorial restrictions.....	306

5.3.2.3 Ambiguity due to regulations.....	306
5.3.2.4 Clarity and precision.....	306
5.3.2.5 Subjectivity.....	307
5.3.2.6 Targeted public.....	307
5.3.2.7 Intended use or purpose.....	308
5.3.2.8 Restrictions specifying subject matter.....	308
5.3.3 Wording of amendments.....	308
5.3.3.1 Amendments with territorial references.....	310
5.3.3.2 Amendments specifying theme.....	310
5.3.4 Influence of punctuation on restrictions and amendments.....	310
5.3.5 Provisions for implementation.....	311
5.3.6 Interpretation going beyond the general criteria.....	311
<b>5.4 Addition of classes.....</b>	<b>311</b>
<b>5.5 Timing of objections.....</b>	<b>312</b>
<b>6 Annex.....</b>	<b>313</b>
<b>6.1 Introduction.....</b>	<b>313</b>
<b>6.2 Accessories for vehicles.....</b>	<b>313</b>
<b>6.3 Advertising services.....</b>	<b>313</b>
<b>6.4 Air freshening and perfuming preparations.....</b>	<b>314</b>
<b>6.5 Amusement apparatus and electronic games.....</b>	<b>314</b>
<b>6.6 Assembly services.....</b>	<b>314</b>
<b>6.7 Association services or services provided by an association to its members.....</b>	<b>315</b>
<b>6.8 Beauty apparatus.....</b>	<b>315</b>
<b>6.9 Blogs (provision of -).....</b>	<b>315</b>
<b>6.10 Bringing together of services.....</b>	<b>316</b>
<b>6.11 Broadcasting and/or transmission services.....</b>	<b>316</b>
<b>6.12 Brokerage services.....</b>	<b>316</b>
<b>6.13 Cases (and carrying bags).....</b>	<b>317</b>
<b>6.14 Charitable services.....</b>	<b>317</b>
<b>6.15 Collection and storage services.....</b>	<b>317</b>
<b>6.16 Consulting and advisory services.....</b>	<b>318</b>
<b>6.17 Commercial intermediation services.....</b>	<b>318</b>
<b>6.18 Computer games and computer games apparatus.....</b>	<b>318</b>
<b>6.19 Curtains and blinds.....</b>	<b>319</b>



<b>6.20 Custom manufacture/manufacturing for third parties.....</b>	<b>319</b>
<b>6.21 Customer services.....</b>	<b>320</b>
<b>6.22 Data services.....</b>	<b>320</b>
<b>6.23 Design services.....</b>	<b>320</b>
<b>6.24 Digital imaging services.....</b>	<b>320</b>
<b>6.25 Downloadable goods and virtual goods.....</b>	<b>321</b>
<b>6.26 Electricity and energy.....</b>	<b>322</b>
<b>6.27 Electronic and electric apparatus.....</b>	<b>322</b>
<b>6.28 Electronic cigarettes.....</b>	<b>323</b>
<b>6.29 Expert opinion services.....</b>	<b>323</b>
<b>6.30 Facilities management services.....</b>	<b>323</b>
<b>6.31 Food additives and food supplements.....</b>	<b>323</b>
<b>6.32 Foodstuffs.....</b>	<b>324</b>
<b>6.33 Franchising.....</b>	<b>324</b>
<b>6.34 Gadgets.....</b>	<b>325</b>
<b>6.35 GPS systems - location, tracking and navigating.....</b>	<b>325</b>
<b>6.36 Hair styling.....</b>	<b>326</b>
<b>6.37 Hire services.....</b>	<b>327</b>
<b>6.38 Hotline services.....</b>	<b>327</b>
<b>6.39 Humanitarian aid services.....</b>	<b>327</b>
<b>6.40 Internet services, online services.....</b>	<b>327</b>
<b>6.41 Kits and sets.....</b>	<b>328</b>
<b>6.42 Leasing.....</b>	<b>329</b>
<b>6.43 Mail order.....</b>	<b>329</b>
<b>6.44 Manuals (for computers, etc.).....</b>	<b>329</b>
<b>6.45 Manufacturing services.....</b>	<b>330</b>
<b>6.46 News services.....</b>	<b>330</b>
<b>6.47 Online services.....</b>	<b>330</b>
<b>6.48 Ordering of services.....</b>	<b>331</b>
<b>6.49 Perfuming and air freshening preparations.....</b>	<b>331</b>
<b>6.50 Personal and social services rendered by others to meet the needs of individuals.....</b>	<b>331</b>
<b>6.51 Personal assistant services.....</b>	<b>332</b>
<b>6.52 Precious metal goods.....</b>	<b>332</b>

<b>6.53 Protective clothing.....</b>	<b>333</b>
<b>6.54 Providing a website.....</b>	<b>333</b>
<b>6.55 Providing an online platform.....</b>	<b>333</b>
<b>6.56 Providing downloadable content.....</b>	<b>334</b>
<b>6.57 Providing information.....</b>	<b>334</b>
<b>6.58 Rental services.....</b>	<b>334</b>
<b>6.59 Reservation services and booking services.....</b>	<b>335</b>
<b>6.60 Retail and wholesale services.....</b>	<b>335</b>
<b>6.61 Retail of pre-paid cards.....</b>	<b>337</b>
<b>6.62 Robots.....</b>	<b>337</b>
<b>6.63 Satellite tracking.....</b>	<b>338</b>
<b>6.64 Sets.....</b>	<b>338</b>
<b>6.65 Smartwatches and activity bracelets.....</b>	<b>338</b>
<b>6.66 Social networking services.....</b>	<b>338</b>
<b>6.67 Software publishing.....</b>	<b>338</b>
<b>6.68 Solar power.....</b>	<b>339</b>
<b>6.69 Statistics.....</b>	<b>339</b>
<b>6.70 Storage services.....</b>	<b>339</b>
<b>6.71 Supply of .....</b>	<b>340</b>
<b>6.72 Systems.....</b>	<b>340</b>
<b>6.73 Tickets (for travel, entertainment, etc.).....</b>	<b>340</b>
<b>6.74 Tourist/Holiday services.....</b>	<b>341</b>
<b>6.75 Video games.....</b>	<b>341</b>
<b>6.76 Virtual environment.....</b>	<b>341</b>
<b>6.77 Wellness and well-being services.....</b>	<b>341</b>

# 1 Introduction

Recital 28, Regulation (EU) 2017/1001

Articles [4](#), [31](#), [33](#), [49](#) and [57](#) EUTMR

European Union trade mark protection is granted in relation to specific goods or services which determine the extent of protection afforded to the trade mark proprietor. It is, therefore, essential to lay down rules for the indication and the classification of goods and services and to ensure legal certainty.

The indication of goods and services corresponds to one of the essential characteristics of a trade mark ([Article 4 EUTMR](#)). For a filing date to be accorded, every EUTM application must contain a list of goods and services ([Article 31\(1\)\(c\) EUTMR](#)).

The list of goods and services for which protection is sought must be (a) identified by the applicant with sufficient clarity and precision to enable the competent authorities and economic operators to determine the extent of the protection sought and (b) grouped according to the classes of the Nice Classification ([Article 33\(2\) and \(6\) EUTMR](#)).

The list of goods and services may be restricted or amended by the applicant in the application, provided that the restriction or amendment does not extend the list of goods and services ([Article 49 EUTMR](#)). After registration the trade mark may be surrendered in respect of some of the goods and services ([Article 57 EUTMR](#)).

Use of the Office's administrative IT tools for classification (see [paragraph 3](#)) is highly recommended. Any part of the list of goods and services that does not match the data from the tools will be examined following the principles set out in these Guidelines. Whenever the applicant selects a term from the available tools, it will **not be examined** any further, thus **speeding up the registration procedure**.

The purpose of this Section of the Guidelines is to describe Office practice in examining the classification of goods and services.

The first part ([paragraphs 1 to 4](#)) sets out the principles applied by the Office. The second part ([paragraph 5](#)) summarises the procedure for examining the list of goods and services.

In short, when examining the classification of a list of goods and services, the Office will carry out four tasks:

- checking that each of the goods and services is sufficiently clear and precise;
- checking that each term belongs to the class in which it is listed;
- notifying any deficiency;
- refusing the application, in whole or in part, where the deficiency is not remedied ([Article 41\(4\) and \(8\) EUTMR](#)).

For information on the language from which the examination of classification and the translations are made, see [the Guidelines, Part B, Examination, Section 2, Formalities, paragraph 6.3, Reference language for translations](#).

## 2 The Nice Classification

Goods and services in respect of which trade mark registration is applied for are classified in accordance with the system of classification established by the Nice Agreement Concerning the International Classification of Goods and Services for the Purposes of the Registration of Marks of 15 June 1957 (the Nice Classification). The Nice Classification is administered by the World Intellectual Property Organization (WIPO) ([Article 33\(1\) EUTMR](#)).

Goods and services are organised in classes to facilitate pre-clearance searches before filing an application to avoid conflict, to allow surveillance searches and in order to monitor possible competition. In addition, the classes are taken into account to calculate class fees.

As a system aimed at reflecting market needs, the Nice Classification is updated on a regular basis. Minor improvements are published every year in versions of the current edition, while significant changes are incorporated in a new edition every 5 years.

The version of the classification under the Nice Agreement in force at the filing date will be applied to the classification of the goods or services in an application. [Article 33 EUTMR](#) requires every list of goods and services to:

- be identified by the applicant with sufficient clarity and precision to enable the competent authorities and economic operators to determine the extent of the protection sought;
- be arranged according to the Nice Classification, with each group preceded by the number of the class to which the goods or services belong, and presented in the order of the classes.

The Nice Classification contains guidance for classification.

1. **Class Headings** — these exist for each class and indicate in a general manner the fields to which, in principle, the goods or services belong.
2. **Explanatory Notes** — these exist for each class and clarify, in a more abstract manner, the criteria of which type or examples of goods or services are included, or not included, in the class.
3. **Alphabetical List** — this may be consulted in order to ascertain the exact classification of individual goods or services by analogy.
4. **General Remarks** — placed at the beginning of the Nice Classification, these are a short collection of basic principles explaining what criteria should be applied if a term cannot be classified in accordance with the Class Headings or Alphabetical List.

More information regarding the Nice Classification can be found on WIPO's website at: <http://www.wipo.int>.

### 3 Other Administrative Tools for Classification Purposes

Communication No [1/13](#) of the President of the Office of 26/11/2013 concerning a new administrative tool for classification purposes (taxonomy) and the use of class headings of the Nice Classification.

When filing an electronic application, users can select preapproved terms to build their list of goods and services. These terms originate from the Harmonised Database (HDB) and will automatically be accepted for classification purposes. Using these preapproved terms will facilitate a smoother trade mark registration process. The HDB brings together terms that are accepted for classification purposes in all EU offices.

Should the applicant use a list of goods and services that has terms not found in the HDB, the Office will have to examine whether they can be accepted.

Before filing an application, users can search the content of the HDB using the Office's TMclass tool (<http://tmclass.tmdn.org/ec2/>). This tool brings together classification databases of participating offices both within and outside the EU and shows whether a term is accepted by the office concerned. TMclass groups goods and services according to shared characteristics from a market perspective, starting from the more general and ending with the more specific. This offers users a simplified search and a better overview of the content of each class, thus facilitating the selection of appropriate terms. This grouping and ranking, also called taxonomy, has no legal effect, since the scope of protection of an EUTM is always defined by the natural and usual meaning of the terms chosen, not by their position in the hierarchical structure of the Office's taxonomy (10/12/2015, [T-690/14](#), Vieta, EU:T:2015:950, § 66).

Users can also use the Goods and Services Builder at: <https://euipo.europa.eu/ohimportal/en/gsbuilder>, which will guide them through the process of creating their list of goods and services on the basis of terminology from the HDB.

## 4 Building a List of Goods and Services

### 4.1 Choosing adequate scope of protection

The essential function of the protection afforded by a trade mark is to guarantee to the consumer an indication of origin of the goods or services, by enabling him or her, without any possibility of confusion, to distinguish the goods or services from others that have another origin.

Furthermore, the indication of goods and services may be restricted ([Article 49 EUTMR](#)) or surrendered ([Article 57 EUTMR](#)) at any time, but the initial scope of protection may never be broadened.

With that in mind, it is of crucial importance to carefully designate a list of goods and services that:

- not only covers the current interests in protection but takes into account also future possibilities, by indicating categories of goods or services the trade mark proprietor might be likely to expand to,
- but also reduces potential conflict with other marks and minimises the risk of becoming vulnerable to attack, by avoiding an overly broad or unnecessarily long list of goods and services.

As far as services for which trade mark protection can be sought are concerned, these are, in principle, generally offered independently to third parties and supplied for an economic consideration. Services connected with goods, such as the research and development of an undertaking's own products, do not constitute an external service for third parties. If a service is not provided to third parties, but is only an internal working of the undertaking, it would be redundant for it to be covered in the list of goods and services of the application (30/09/2016, [T-355/15](#), ASTEX / ALPEX, EU:T:2016:591, § 37). The same applies to ancillary services, such as the manufacture, sale or advertising of an undertaking's own products.

## **4.2 Clarity and precision**

### **4.2.1 General principles**

The goods and services for which protection of the trade mark is sought must be identified by the applicant with sufficient clarity and precision to enable the competent authorities and economic operators, on that basis alone, to determine the extent of protection sought ([Article 33\(2\) EUTMR](#)).

An indication of goods and services is sufficiently clear and precise when its scope of protection can be understood from its natural and usual meaning.

'Natural and usual meaning' refers to the general definition of a term, in other words how the term is commonly understood. It will frequently be defined by a grammatical interpretation in the language in which the application is filed, by definitions given in the Nice Classification, by use in dictionaries and encyclopaedias, and by the commercial language of traders.

The examination of the indication of goods and services as being clear and precise is independent of the examination as to absolute or relative grounds.

### **4.2.2 Influence of classification on the scope of protection**

A correct classification should in principle be enough to allow for an unambiguous scope of protection. A particular term may be part of the description of goods and services in different classes, but equally it may be clear and precise in a particular

class without further specification. In this case its natural and usual meaning and the class number will leave no doubt as to the scope of protection.

For example, the natural and usual meaning of the term *clothing* is garments for humans with the purpose of covering the body for normal use. Therefore, this term would leave no doubt as to the scope of protection if applied for in Class 25 (see the Explanatory Note for Class 25).

If the scope of protection cannot be understood, sufficient clarity and precision may be achieved by further identifying factors such as characteristics, purpose and/or identifiable market sector. <sup>(7)</sup> Elements that could help to identify the market sector may be, but are not limited to, the following:

- consumers and/or sales channels;
- skills and know-how to be used/produced;
- technical capabilities to be used/produced.

If protection is sought for a specialised category of goods and services or a specialised market sector belonging to a different class, further specification of the term may be necessary.

For example: *clothing for protection against fire* (Class 9);

*clothing for operating rooms* (Class 10);

*clothing for pets* (Class 18);

*clothing for dolls* (Class 28).

From these examples it is obvious that the term *clothing* can be interpreted in various ways but must always be defined by purpose or market sector pertaining to a particular Nice class. In addition, it shows that *clothing* in Class 25 would **not** cover any of the categories of goods mentioned above.

In principle, the Office understands the class number as being indicative of the characteristics of the goods or services, such as the predominant material, the main purpose or the relevant market sector, considering the natural and usual meaning of each term at the same time. Each term is assessed in the context of the class in which it is applied for (25/01/2018, [T-367/16](#), H HOLY HAFERL HAFERL SHOE COUTURE (fig.) / HOLY et al.; EU:T:2018:28, § 50; 19/06/2018, [T-89/17](#), NOVUS / NOVUS (fig.) et al., EU:T:2018:353, § 32-33).

Tools such as TMclass (<http://tmclass.tmdn.org/ec2/>), as well as the Goods and Services Builder functionality at: <https://euipo.europa.eu/ohimportal/en/gsbuilder>, both of which are based on the HDB, are available for determining whether the particular category of goods and services needs further specification or not.

---

<sup>7</sup> Market sector describes a set of businesses that are buying and selling such similar goods and services that they are in direct competition with each other.

#### 4.2.3 Use of expressions (e.g. 'namely', 'in particular') to determine the scope of the list of goods/services

The use of the words 'namely' or 'being' is acceptable but must be understood as a restriction to the specific goods and services listed thereafter (04/10/2016, [T-549/14](#), *Castello / Castellò* (fig.) et al., EU:T:2016:594, § 71). For example, *pharmaceutical preparations, namely analgesics* in Class 5 means that the application only covers analgesics and not any other type of pharmaceuticals.

The expression 'in particular' can also be accepted as it serves to indicate an example of the goods and services applied for. For example, *pharmaceutical preparations, in particular analgesics* means that the application covers any kind of pharmaceuticals, with *analgesics* being an example.

The same interpretation applies to use of the terms 'including', 'including (but not limited to)', 'especially' or 'mainly', as in the example *pharmaceutical preparations, including analgesics*.

A term that would normally be considered unclear or imprecise can be made acceptable by making it more specific, for example, by using 'namely' and a list of acceptable terms. Examples include *goods of common metal, namely, screws* for goods in Class 6 and *goods of precious metals, namely bracelets* for goods in Class 14.

The HDB does not currently support use of the terms 'namely' or 'in particular'. Therefore, if these terms are used in the list of goods and services, the classification will not be accepted automatically but will require verification, which may slow down the examination procedure.

##### Examples of acceptable use

Class 29: <i>Dairy products namely cheese and butter</i>	'Namely' restricts the goods to cheese and butter, excluding all other dairy products.
Class 41: <i>Provision of sports facilities, all being outdoors</i>	This restricts the services to the provision of outdoor sports facilities, excluding the provision of any indoor sports facilities.
Class 25: <i>Clothing, all being underwear</i>	The goods are restricted to those considered underwear, excluding all other types of clothing.

Specifications using 'namely' or 'being' in a manner that does not comply with the requirements of clarity and precision (e.g. *dairy products, namely peanut butter*) jeopardise the scope of protection and will therefore be objected to, and might eventually lead to a refusal of the same.

##### Examples of non-restrictive use

Other words or phrases may only point out that certain goods/services are important, and the inclusion of the term does not restrict the list in any way.



Class 29: <i>Dairy products, in particular cheese and butter</i>	This includes all dairy products; cheese and butter are probably the focus of the EUTM owner's operation, but not the only goods produced.
Class 41: <i>Provision of sports facilities, for example outdoor running tracks</i>	The coverage merely gives an example of one of several possibilities.
Class 25: <i>Clothing, including underwear</i>	The coverage extends to all clothing and not just underwear.

Specifications using 'in particular', 'such as', 'for example' or 'including' in a manner that does not comply with the requirements of clarity and precision (e.g. *dairy products, in particular peanut butter*) jeopardise the scope of protection, and will therefore be objected to, and might eventually lead to a refusal of the same.

For the correct use of restrictive wordings (e.g. 'excluding', 'except') please refer to the examples listed in [paragraph 5.3.2](#).

#### 4.2.4 Use of the term 'and/or'

The use of oblique strokes is acceptable in lists of goods and services; the most common example is in the phrase '*and/or*', meaning that both goods or services referred to are covered.

##### Examples

- *Chemical/biochemical products*
- *Chemical and/or biochemical products*
- *Chemicals for use in industry/science*
- *Chemicals for use in industry and/or science*
- *Import/export agency services.*

#### 4.2.5 Punctuation

The use of correct punctuation is very important in a list of goods and services — almost as important as the words.

The use of commas may serve to separate enumerated items within a broader category or expression. For example, *flour and preparations made from cereals, bread, pastry and confectionery* in Class 30 means that the goods can be or are made from any of those materials, thus also including the rather nonsensical *preparations made from confectionery*. If the meaning of the part of the term after *preparations made from cereals* is nonsensical, the use of a comma after it is inappropriate, and a semicolon should be used instead.

The use of a semicolon means a separation between expressions. For example, *flour and preparations made from cereals; bread, pastry and confectionery* in Class 30. In this example, the terms *bread, pastry and confectionery* must be interpreted as being

independent from the other terms and not as being included in *preparations made from bread, pastry and confectionery*.

The separation of terms with incorrect punctuation can lead to changes in meaning and incorrect classification.

Take the example of *computer software for use with textile machinery; agricultural machines* in Class 9. In this list of goods and services, the inclusion of a semicolon means that the term *agricultural machines* must be considered as an independent category of goods. However, *agricultural machines* are proper to Class 7. The term would have to be objected to by proposing the correct classification.

A further example would be *retail services in relation to clothing; footwear; headgear* in Class 35. The use of a semicolon means that the terms *footwear* and *headgear* refer to separate goods, not included in the retail services. In service classes, the goods listed in relation to the services for which protection is sought should always be separated by commas.

A colon can be used in a list of goods and services to explain or start an enumeration. In an enumeration following a colon, terms should be separated by a comma. An example in Class 9 is *Software for: computers, mobile phones, tablets*.

An expression between brackets is in most cases intended to define more precisely the text preceding the brackets where the latter is ambiguous.

#### 4.2.6 Inclusion of abbreviations and acronyms in lists of goods and services

Abbreviations and acronyms within lists of goods and services should be accepted with caution. Trade marks could have an indefinite life, and the interpretation of an abbreviation could vary over time. However, provided that an abbreviation has only one meaning in relation to the class of goods or services applied for, it can be allowed. The very well-known examples *CD-ROMs* and *DVDs* are acceptable in Class 9. If the abbreviation is well known in the field of activity it will be acceptable. To this end, examiners will carry out an internet search in order to determine whether the abbreviation needs to be expanded into words.

##### Example

Class 9: *EPROM cards*.

This could be expanded to:

Class 9: *Erasable programmable read-only memory cards*.

or

Class 9: *EPROM [erasable programmable read-only memory] cards*.

## 4.3 Terms lacking clarity and precision

### 4.3.1 General indications of Nice Classification class headings lacking clarity and precision

In accordance with [Article 33\(3\) EUTMR](#), general indications included in the class headings of the Nice Classification or other general terms may be used, provided that they comply with the requisite standards of clarity and precision, as set out in [Article 33\(2\) EUTMR](#).

For the sake of completeness, it is noted that, in accordance with [Article 33\(5\) EUTMR](#), the use of general terms, including general indications of the class headings of the Nice Classification, will be interpreted as including all goods or services clearly covered by the literal meaning of the indication or term within the context of the class in which it is applied for. <sup>(8)</sup> The use of such terms or indications will not be interpreted as comprising a claim to goods or services that cannot be understood in this way.

In collaboration with the trade mark offices of the European Union, other (inter)national organisations, offices and various user associations, the Office has established a list of general indications of Nice Classification class headings that are deemed not to be sufficiently clear and precise in accordance with [Article 33\(2\) EUTMR](#).<sup>(9)</sup>

The 197 general indications of the Nice class headings in the 2014 version of the 10th Edition of the Nice Classification were examined for the requisites of clarity and precision. Of these, 11 were considered not to have the clarity and precision required to specify the scope of protection that they would give. Consequently, they could not be accepted without further specification. The indications in question are set out below in **bold**.

Class 6: **Goods of common metal not included in other classes.**

Class 7: **Machines and machine tools.**

Class 14: **Precious metals and their alloys and goods in precious metals or coated therewith, not included in other classes.**

Class 16: **Paper, cardboard and goods made from these materials [paper and cardboard], not included in other classes.**

Class 17: **Rubber, gutta-percha, gum, asbestos, mica and goods made from these materials [rubber, gutta-percha, gum, asbestos and mica] and not included in other classes.**

Class 18: **Leather and imitations of leather, and goods made of these materials [leather and imitations of leather] and not included in other classes.**

---

<sup>8</sup> The Office's former practice, according to which use of all the general indications listed in the class heading of a particular class constituted a claim to all goods or services falling under the class was abandoned in June 2012.

<sup>9</sup> See the [Common Communication on the Acceptability of Classification Terms and the General Indications of the Nice Class Headings \(CP1\)](#).

Class 20: **Goods (not included in other classes) of wood, cork, reed, cane, wicker, horn, bone, ivory, whalebone, shell, amber, mother-of-pearl, meerschaum and substitutes for all these materials, or of plastics.**

Class 37: **Repair.**

Class 37: **Installation services.**

Class 40: **Treatment of materials.**

Class 45: **Personal and social services rendered by others to meet the needs of individuals.**

The remaining 186 general indications comply with the requisites of clarity and precision and are therefore acceptable for classification purposes.

The reasons why each of the 11 general indications of the Nice class headings were not found clear and precise are described below.

Class 6: **Goods of common metal not included in other classes.**

In light of the need for clarity and precision, this term does not provide a clear indication of what goods are covered as it simply states what the goods are made of, and not what the goods are. It covers a wide range of goods that may have very different characteristics and/or purposes, may require very different levels of technical capabilities and know-how to be produced and/or used, and could target different consumers, be sold through different sales channels and therefore relate to different market sectors.

Class 7: **Machines and machine tools.**

In light of the need for clarity and precision, the term *machines* does not provide a clear indication of what machines are covered. Machines can have different characteristics or different purposes, may require very different levels of technical capabilities and know-how to be produced and/or used, and could target different consumers, be sold through different sales channels and therefore relate to different market sectors.

Class 14: **Precious metals and their alloys and goods in precious metals or coated therewith, not included in other classes.**

In light of the need for clarity and precision, the term *goods in precious metals or coated therewith, not included in other classes* does not provide a clear indication of what goods are covered, as it simply states what the goods are made of or coated with, and not what the goods are. It covers a wide range of goods that may have very different characteristics, may require very different levels of technical capabilities and know-how to be produced, and could target different consumers, be sold through different sales channels and therefore relate to different market sectors.

Class 16: **Paper, cardboard and goods made from these materials, not included in other classes.**

In light of the need for clarity and precision, the term *goods made from these materials [paper and cardboard], not included in other classes* does not provide a clear indication of what goods are covered, as it simply states what the goods are made of, and not what the goods are. It covers a wide range of goods that may have very different

characteristics and/or purposes, may require very different levels of technical capabilities and know-how to be produced and/or used, and could target different consumers, be sold through different sales channels and therefore relate to different market sectors.

**Class 17: *Rubber, gutta-percha, gum, asbestos, mica and goods made from these materials and not included in other classes.***

In light of the need for clarity and precision, the term *goods made from these materials [rubber, gutta-percha, gum, asbestos and mica] and not included in other classes* does not provide a clear indication of what goods are covered as it simply states what the goods are made of, and not what the goods are. It covers a wide range of goods that may have very different characteristics and/or purposes, may require very different levels of technical capabilities and know-how to be produced and/or used, and could target different consumers, be sold through different sales channels and therefore relate to different market sectors.

**Class 18: *Leather and imitations of leather, and goods made of these materials and not included in other classes.***

In light of the need for clarity and precision, the term *goods made of these materials [leather and imitations of leather] and not included in other classes* does not provide a clear indication of what goods are covered, as it simply states what the goods are made of, and not what the goods are. It covers a wide range of goods that may have very different characteristics and/or purposes, may require very different levels of technical capabilities and know-how to be produced and/or used, and could target different consumers, be sold through different sales channels and therefore relate to different market sectors.

**Class 20: *Goods (not included in other classes) of wood, cork, reed, cane, wicker, horn, bone, ivory, whalebone, shell, amber, mother-of-pearl, meerschaum and substitutes for all these materials, or of plastics.***

In light of the need for clarity and precision, this term does not provide a clear indication of what goods are covered as it simply states what the goods are made of, and not what the goods are. It covers a wide range of goods that may have very different characteristics and/or purposes, may require very different levels of technical capabilities and know-how to be produced and/or used, and could target different consumers, be sold through different sales channels and therefore relate to different market sectors.

**Class 37: *Repair services.***

In light of the need for clarity and precision, this term does not provide a clear indication of the services being provided, as it simply states that these are repair services, and not what is to be repaired. As the goods to be repaired may have different characteristics, the repair services will be carried out by service providers with different levels of technical capabilities and know-how, and may relate to different market sectors.

**Class 37: *Installation services.***

In light of the need for clarity and precision, this term does not provide a clear indication of the services being provided, as it simply states that these are installation services, without stating what is to be installed. As the goods to be installed may have different characteristics, the installation services will be carried out by service providers with different levels of technical capabilities and know-how, and may relate to different market sectors.

**Class 40: *Treatment of materials.***

In light of the need for clarity and precision, this term does not give a clear indication of the services being provided. The nature of the treatment is unclear, as are the materials to be treated. These services cover a wide range of activities performed by different service providers on materials of different characteristics, requiring very different levels of technical capabilities and know-how, and may relate to different market sectors.

**Class 45: *Personal and social services rendered by others to meet the needs of individuals.***

In light of the need for clarity and precision, this term does not give a clear indication of the services being provided. These services cover a wide range of activities performed by different service providers requiring very different levels of skill and know-how, and may relate to different market sectors.

Six general indications were deleted from the class headings of the 2016 version of the 10th edition of the Nice Classification, and one more deleted in the 12th edition. The remaining indications are set out below in bold:

**Class 7: *Machines and machine tools.***

**Class 37: *Repair services.***

**Class 37: *Installation services.***

**Class 40: *Treatment of materials.***

**Class 45: *Personal and social services rendered by others to meet the needs of individuals.***

EUTM applications that include any of the abovementioned general indications contained in the current or earlier versions or editions of the Nice Classification will be objected to as lacking clarity and precision. The applicant will be asked to make the unacceptable term more specific.

Unacceptable general indications mentioned above can be made clear and precise if the applicant follows the principles set out under [paragraph 4.2](#). The following is a non-exhaustive list of acceptable specifications.

Not a clear and precise term	Example of a clear and precise term
<i>Goods of common metal not included in other classes (Class 6)</i>	<i>Construction elements of metal (Class 6)</i> <i>Building materials of metal (Class 6)</i>

Not a clear and precise term	Example of a clear and precise term
<i>Machines</i> (Class 7)	<i>Agricultural machines</i> (Class 7) <i>Machines for processing plastics</i> (Class 7) <i>Milking machines</i> (Class 7)
<i>Goods in precious metals or coated therewith</i> (Class 14)	<i>Works of art of precious metal</i> (Class 14)
<i>Goods made from paper and cardboard</i> (Class 16)	<i>Filtering materials of paper</i> (Class 16)
<i>Goods made from rubber, gutta-percha, gum, asbestos and mica</i> (Class 17)	<i>Rings of rubber</i> (Class 17)
<i>Goods made of these materials [leather and imitations of leather]</i> (Class 18)	<i>Leather straps</i> (Class 18)
<i>Goods (not included in other classes) of wood, cork, reed, cane, wicker, horn, bone, ivory, whalebone, shell, amber, mother-of-pearl, meerschaum and substitutes for all these materials, or of plastics</i> (Class 20)	<i>Door fittings, made of plastics</i> (Class 20) <i>Figurines of wood</i> (Class 20)
<i>Repair services</i> (Class 37)	<i>Shoe repair</i> (Class 37) <i>Repair of computer hardware</i> (Class 37)
<i>Installation services</i> (Class 37)	<i>Installation of doors and windows</i> (Class 37) <i>Installation of burglar alarms</i> (Class 37)
<i>Treatment of materials</i> (Class 40)	<i>Treatment of toxic waste</i> (Class 40) <i>Air purification</i> (Class 40)
<i>Personal and social services rendered by others to meet the needs of individuals</i> (Class 45)	<i>Personal background investigations</i> (Class 45) <i>Personal shopping for others</i> (Class 45) <i>Adoption agency services</i> (Class 45)

Unclear or imprecise general indications of services used in combination with unclear or imprecise general indications of goods may be acceptable if a market sector or a specific skill needed to provide such services is clearly distinguished. Unclear or imprecise general indications of goods might be acceptable when applied for together with *repair services*, but not when applied for together with *retail services* if a specific market sector or specific skill needed to provide such services cannot be clearly distinguished. For example, the *repair of leather goods* would be considered sufficiently clear and precise, as the professionals carrying out those repairs would mostly be cobblers, regardless of further characteristics of the goods. However, the *retail of leather goods* would be considered unclear and imprecise since the market sector for

the *retail of leather goods* cannot be identified, and will depend on the specific leather articles or types of leather goods concerned. The practice regarding retail services in connection with goods that are considered unclear and imprecise is explained further in the Annex, in [6.59 Retail and wholesale services](#).

Note that terms lacking clarity and precision cannot be made specific, or acceptable, by the addition of such terms as 'including', 'in particular', 'for example' or 'such as', as well as 'included in this class' or 'not included in other classes'. The example *machines, including milking machines* would not be acceptable as it remains unclear and imprecise (see [paragraph 4.2.3](#)).

#### 4.3.2 Other terms lacking clarity and precision

The same principles regarding clarity and precision as described under [paragraph 4.2](#) are applicable to all the goods and services listed in an application. Terms that do not provide a clear indication of the goods or services covered should be objected to.

##### Examples

- *Merchandising articles*
- *Fair-trade goods*
- *Lifestyle accessories*
- *Gift articles*
- *Souvenirs*
- *Collectors' articles*
- *Housewares*
- *Electronic goods* (01/12/2016, [T-775/15](#), Ferli, EU:T:2016:699), *electric/electronic apparatus/instruments*
- *Gadgets (electronic or not)*
- *Hobby articles*
- *Advertising articles*
- *Memorabilia*
- *Wellness goods*
- *Association services*.

All of these must be made more specific as described above, that is to say, by identifying factors such as characteristics, purpose and/or identifiable market sector.

It should be noted that the means by which a service is provided usually does not render a term sufficiently clear and precise. For classification purposes it is mostly irrelevant whether a service is provided online, on the telephone, by means of a catalogue, in a physical shop, or on-site in person.

More examples can be found in the [Annex](#).



#### 4.3.3 The claim for all goods/services in a class or all goods/services of the alphabetical list in a class

If applicants intend to protect all goods or services included in the alphabetical list of a particular class, they must indicate this by listing these goods or services explicitly and individually. The Office provides tools and functionalities, such as the Goods and Services Builder and TMclass, to guide applicants through the search for goods and services by providing them with suggestions for acceptable goods or services or by starting from the more general terms and ending with the more specific. Use of the Goods and Services Builder and the TMclass hierarchical structure for guidance and search purposes is encouraged (see [paragraph 3](#)).

Applications are sometimes filed with terms such as 'all goods in Class X', 'all services in Class X', 'all goods/services in Class X', 'all goods/services of the alphabetical list in Class X', either on their own, or together with an acceptable list of goods/services. These terms do not constitute a valid claim within the meaning of [Article 33\(2\) EUTMR](#) because they lack sufficient clarity and precision to determine the extent of the protection sought. The Office will invite the applicant to provide acceptable terms within a time limit set to that effect. Failure to do so will result in the application being rejected for such unclear and imprecise terms. It may proceed **only** for the acceptable part of the goods/services.

On other occasions, applications are filed merely stating the class number. This does not comply with [Article 31\(1\)\(c\) EUTMR](#), whereby a list of the goods or services for which the registration is requested must be given. Consequently, in these cases, in the absence of a list of goods or services in respect of which registration is sought, no filing date will be accorded pursuant to [Article 32 EUTMR](#). The Office will invite the applicant to remedy the deficiency. If the deficiency is remedied within the given time limit, the filing date will become the date on which a list of goods and services has been provided. See [the Guidelines, Part B, Examination, Section 2, Formalities, paragraph 4.1](#).

#### 4.3.4 Reference to other classes within the list

References to other class numbers within a class are not acceptable for classification purposes. For example, the indications (in Class 39) *transport services of all goods in Classes 32 and 33* or (in Class 9) *computer software in the field of services in Classes 41 and 45* are not acceptable as in both cases the terms are considered to be unclear and imprecise and lack legal certainty as to what goods and services are covered. The only way to overcome the objection to these lists of goods and services is for the respective goods of Classes 32 and 33, and services of Classes 41 and 45 to be specified in more detail.

The term 'goods not included in other classes' is not acceptable in service classes because this expression only makes sense in its original goods class.

For example, *transport services of plastic materials for packaging (not included in other classes)* in Class 39 could not be accepted. The mention of *(not included in other*

classes) must be deleted so that the term reads *transport services of plastic materials for packaging*.

#### 4.3.5 Trade marks in lists of goods/services

Trade marks may not be used as generic terms or categories of goods. Therefore they will not be accepted as goods or services per se.

##### Example

Class 9: *Electronic devices for transmission of sound and images; video players; CD players; iPods*.

Since iPod™ is a trade mark, the applicant will be requested to replace it by a synonym such as *a small portable digital audio player for storing data in a variety of formats including MP3*.

Other examples are Caterpillar™ (the correct classification would be *crawler type vehicle*), Discman™ (*portable compact disc player*), Band-Aid™ (*sticking plasters*), Blu-Ray discs™ (*optical storage discs with enhanced capacity*) or Teflon™ (*non-stick coating based on polytetrafluoroethylene*). This list is not exhaustive. If third parties are concerned about the generic use of a registered trade mark within a list of goods and services of an application, they may file observations to that effect.

The Office will object to the inclusion of such terms and request that they are replaced by a generic term for the goods or services in question.

#### 4.3.6 Geographical indications in lists of goods and services

Geographical indications (GIs) may not be used as generic terms. Therefore, they will not be accepted as goods per se. In order to avoid protected GIs contained in lists of goods and services being perceived as generic terms (as GIs identify goods that must comply with particular specifications), the generic use of such terms will be objected to, and it will be proposed to add GI-related references.

The wording that the Office recommends is “[GI name] (GI) [product covered by the GI]”. Other limitations are, however, acceptable as long as the applicant clearly identifies the GI and the use thereof.

##### Unacceptable examples

Class 33: *Tequila; champagne*.

Since [Tequila](#) and [Champagne](#) are protected GIs, they must be indicated as such. The applicant will be requested to specify these as GIs and show the goods, namely, *'Tequila' (GI) agave spirit drinks; 'Champagne' (GI) wine*.

GIs protected in the EU can be searched in [Giview](#).

#### 4.3.7 Inclusion of the terms *parts and fittings*; *components* and *accessories* in lists of goods and services

The terms *parts and fittings*; *components* and *accessories* are, on their own or in combination with each other, neither clear nor precise. Accordingly they cannot be classified properly. Each of the terms requires further qualification to become acceptable in its proper class. Such terms could be made acceptable by adding identifying factors such as characteristics, purpose and/or identifiable market sector. It should be noted that the protection afforded by such indications will be interpreted as being limited by the scope of the class. Parts and fittings, components or accessories not belonging to that class will not be understood as covered by such indications.

##### Examples of acceptable terms

- *Parts and fittings for land vehicles* is acceptable in Class 12;
- *Building components of wood* is acceptable in Class 19;
- *Musical accessories* is acceptable in Class 15.

In all cases the requirements of clarity and precision must also be met.

Adding the expression *parts and fittings for all the aforementioned goods* at the end of a list will be accepted as long as it can reasonably be applied to at least one of the goods in that class. In such a case, however, the parts and fittings will be considered to cover only the goods for which they can reasonably be pertinent. For example, if the wording of Class 9 reads *computers; mobile phones; software; parts and fittings for all the aforementioned goods*, then the parts and fittings can only concern *computers* and *mobiles phones*. As *software* relates to goods which are virtual, it is not seen as having *parts and fittings*.

##### Examples of what will **not** be accepted

- Class 5 — *Pharmaceutical preparations; parts and fittings for all the aforementioned goods*.
- Class 16 — *Paper and cardboard; accessories for all the aforementioned goods*.
- Class 29 — *Meat, fish, poultry and game; components of all the aforementioned goods*.

#### 4.3.8 Use of indefinite qualifiers

The use of qualifiers such as ‘the like’, ‘ancillary’, ‘associated goods’, ‘and related goods’ or ‘etc.’ in a list of goods or services is unacceptable, since they do not comply with the requirements of clarity and precision (see [paragraph 4.2](#)).

## 5 Examination Procedure

### 5.1 Parallel applications

While the Office will always strive for consistency, the fact that a wrongly classified list of goods and services has previously been accepted does not have to lead to the same list being accepted in any subsequent applications. See [the Guidelines, Part A, General Rules, Section 2, General Principles to be Respected in the Proceedings, paragraph 3](#).

### 5.2 Objections

Where the Office considers that there is a need to amend the list of goods and services according to its practice, it will issue a reasoned objection. The Office may propose how the items should be classified and provide analogous examples from the HDB. The objection should take into account the class applied for, and the natural and usual meaning of the term.

#### Examples

- **Natural and usual meaning is clear and class number gives no context (obviously incorrect)**

Where the applicant files for the term *footwear* in Class 3, the examiner will propose to transfer this term to Class 25, even if Class 25 was not listed in the original application, since the natural and usual meaning of this term would be coverings for human feet. If this results in a new class being added this is acceptable.

- **Natural and usual meaning is clear, but class number gives a different context**  
Where the applicant files for the term *footwear* in Class 9, they will be asked to specify the nature or purpose of these goods within the class (protective footwear).
- **Natural and usual meaning is unclear, but class number gives a particular context**

If the applicant files for the term *machines* in Class 7, they should be asked to define the nature or purpose of these goods, as this is not clear from the natural and usual meaning of the term. As the original meaning of the term is unclear, but the class number gives additional information, the term can only be specified within the scope of that class. In such a case, a further specification **only in the class applied for** can be accepted, for instance:

Class 7: *Washing machines; machines for shaping metal.*

- **Natural and usual meaning is unclear and class number gives no context**

If the applicant files for the term *machines* in Class 25, they should be asked to define the nature or purpose of these goods, as this is not clear from the natural and usual meaning or from the class applied for. In such a case, a further specification in all applicable classes can be accepted, for instance:

Class 7: *Washing machines; machines for shaping metal.*

Class 9: *Photocopy machines.*

Class 11: *Bread-making machines; air purification machines.*

As the original meaning of the term was unclear, and the class number gives no additional information, the original scope could not be defined.

Any specification provided by the applicant must not result in the broadening of the original scope of the goods or services originally applied for ([Article 49\(2\) EUTMR](#)). This is not the case when the term being specified can be seen as covered by the natural and usual meaning of broader terms already existing in the original application.

Any additional information applicable to a term that needs to be transferred to a different class should also be taken into account, not only in order to prevent a broadening of the original scope, but also to avoid narrowing it down.

For example, if the original list of goods in Class 12 reads *cars; car radios; parts and fittings for all the aforementioned goods*, the applicant will be requested to transfer the term *car radios* to Class 9, even if Class 9 was not listed in the original application. Such a transfer should also include the phrase *parts and fittings for all the aforementioned goods*.

The list of goods should therefore be amended as follows:

Class 9: *Car radios; parts and fittings for all the aforementioned goods.*

Class 12: *Cars; parts and fittings for all the aforementioned goods.*

For example, if the original list of services in Class 43 reads *travel reservation services; hotel reservation services; information in relation to all the aforementioned services*, as *travel reservation services* are proper to Class 39, the applicant will be requested to transfer the term to Class 39, even if Class 39 was not listed in the original application. However, this transfer should also include the *information in relation to all the aforementioned services*.

The list of services should therefore be amended as follows:

Class 39: *Travel reservation services; information in relation to all the aforementioned services.*

Class 43: *Hotel reservation services; information in relation to all the aforementioned services.*

The initial time limit of 2 months allowed for remedying the deficiencies can only be extended once. No further extensions will be granted unless exceptional circumstances apply ([Article 101\(4\) EUTMR](#)). See also the Guidelines [Part A, General Rules, Section 8, Restitutio in Integrum](#).

The Office will send a letter informing the applicant of the list of goods and services as accepted following the amendments.

If the applicant does not remedy the deficiency(ies), the application will be rejected for the goods or services for which an objection has been made.

If the applicant has submitted a long list of goods and services that is not grouped under class numbers or classified at all, an objection under [Article 33 EUTMR](#) will be raised, requesting the applicant to group the goods and services in specific classes.

### 5.3 Restriction and amendment of a list of goods and services

[Article 49\(1\) and \(2\) EUTMR](#) allows for the restriction or amendment of an application before registration, provided that 'such a correction does not substantially change the trade mark or extend the list of goods and services'.

Under [Article 49\(1\) EUTMR](#), the applicant may choose to **restrict** the list of goods and services in order to clarify the scope of protection, to overcome an objection under absolute grounds, to further specify unclear and imprecise indications, or to settle a dispute. The restriction can be effected by deleting a term, further specifying a broad term, or a subcategory of such a term, or excluding terms or subcategories of goods or services.

**Amendments** to the indication of goods and services before registration, under [Article 49\(2\) EUTMR](#), can also be seen as a fine-tuning of the list of goods and services, and therefore can change the wording without necessarily limiting the scope of the application or changing the nature of the goods and services. However, any such fine-tuning may never broaden the scope of the application.

Restrictions made post-registration, however, must comply with the requirements of [Article 57 EUTMR](#) on partial surrender. Once the mark has been entered in the Register, changes to the list of goods and services can only seek to limit the scope of protection, and will be refused if no actual restriction is made. Under no circumstances may the change widen the list of goods and services.

#### 5.3.1 Rules governing restrictions and amendments

A request for restriction or amendment of the list of goods and services in the context of [Article 49 EUTMR](#) takes effect when it is received by the Office and is therefore **formally binding**. This means that the goods or services excluded through a restriction cannot be reinserted into the list of goods and services at a later stage. In order for a request for restriction to be withdrawn, a corresponding declaration must reach the Office on the same day the request for restriction was received. Withdrawal of a restriction received after this date will be dismissed.

Certain **general criteria** must be respected at all times for a restriction or amendment to be acceptable.

- The request must be **explicit**. The absence of a reply to an official notification will never be considered an explicit request for restriction. Where a restriction is required by the Office, silence on the part of the applicant can, however, lead to the refusal of the terms objected to, or, eventually, to the refusal of the application in its entirety.
- The request must be **unconditional**. For instance, if the applicant only wants to restrict the application in return for a fee refund, the request will be considered

inadmissible and the applicant informed accordingly. Otherwise, in this regard, similar rules to those for withdrawals apply (see the Guidelines, [Part B, Examination, Section 1, Proceedings, paragraph 5.1.2](#)).

- A list of goods and services should still be **clear and precise** after a restriction or amendment in order to comply with the requirements of [Article 33 EUTMR](#), and must **not go against legal certainty**.

In any request for a restriction or amendment, the goods/services to be restricted or amended must be clearly indicated (see the Guidelines, [Part B, Examination, Section 1, Proceedings, paragraph 5.2.1](#)).

If the original list of goods and services of an application contains a limiting or amending phrase, these rules will also be applicable as this list must be clear and precise.

### 5.3.2 Wording of restrictions

A restriction should be understood as a clear limitation of the scope of protection.

A restriction can in principle follow one or several of the following approaches, provided they do not contradict each other.

1. **Deletion** of an existing term from the list.
2. **Specification** of a broader term in the list to specific goods or services covered by the broad term, or to one or several subcategories of this term.
3. **Exclusion** of specific goods or services from a broad term, or of one or more subcategories from such a term in the list.

Examples of valid restrictions (in Class 16):

1. **Deletion:** *newspapers; magazines; books* is restricted to read *newspapers; magazines*; the term *books* is completely deleted from the list.
2. **Specification:** *newspapers; magazines; books* is restricted to read *newspapers; magazines; books, namely dictionaries or newspapers; magazines; dictionaries; cookbooks*; the term *books* has been specified to cover only the narrow subcategory of books defined as *dictionaries*, or replaced by the subcategories *dictionaries* and *cookbooks*.
3. **Exclusion:** *newspapers; magazines; books* is restricted to read *newspapers; magazines; books, except dictionaries or newspapers; magazines; books, excluding dictionaries and cookbooks*; the coverage of the term *books* remains fairly broad while at the same time clearly excludes the subcategory of *dictionaries*, or both *dictionaries* and *cookbooks* (from the second wording).

Examples of **contradictory** restrictions (in Class 16), which should therefore be refused:

- *Newspapers; magazines; books* requested to read *newspapers; magazines; all the aforementioned goods except dictionaries* or *newspapers; magazines; all the aforementioned goods being dictionaries*; these restrictions cannot be accepted as,



by excluding the broad category of *books*, the remaining goods to which the restrictions refer no longer contain the subcategory of *dictionaries*.

- *Newspapers; magazines; books, namely dictionaries* requested to read *newspapers; magazines; books, namely dictionaries; all the aforementioned goods except cookbooks*; this restriction cannot be granted as with the specification of the broader category of *books*, the remaining goods to which the restriction could refer, that is to say, *dictionaries*, or even *newspapers* and *magazines*, no longer contain the subcategory of *cookbooks* — or are not even considered to be *books* for that matter, as in the latter case of *newspapers* and *magazines*.

A restriction can result in the deletion of an entire class or, on the contrary, in entering a longer list of goods and services than what was originally applied for. *Newspapers; magazines; books* in Class 16 could, for instance, be restricted to read *newspapers; magazines; books, namely dictionaries, cookbooks, biographies, poetry, fairy tales and philosophy books*.

Furthermore, according to the criteria mentioned under [paragraph 5.3.1](#), the following examples represent acceptable and unacceptable restriction scenarios:

- In order to be able to restrict them, the goods or services need to be **covered by the current list of goods and services** in the class applied for.

Examples of **acceptable** restrictions:

**Class 16:** *Books, namely dictionaries*;

**Class 25:** *Footwear, only being flip-flops*.

Examples of **unacceptable** restrictions concerning different classes:

**Class 5:** *Diagnostic preparations, all for scientific use*;

**Class 7:** *Milling machines, only for dental purposes*.

Although *diagnostic preparations* can be found both in Class 1 and Class 5, Class 5 would only cover those for medical or veterinary purposes. *Diagnostic preparations for scientific use* are proper to Class 1 and therefore cannot be included in Class 5.

Similarly, although *milling machines* could indeed also be used by dental technicians, such goods are not proper to Class 7 but to Class 10. Therefore, it is impossible to include them in Class 7, as they are not proper to that class.

Example of an **unacceptable** restriction within the same class:

**Class 16:** *Newspapers; magazines; books.*

Restriction request: *Newspapers; magazines; books; all the aforementioned goods except pencils*.

In this case, even if *pencils* were proper to the same class, the exclusion of a term that is clearly not covered by the original list of goods and services is nonsensical, and will therefore be objected to.



#### 5.3.2.1 References to trade marks

Generic **references to trade marks** will be objected to.

Example of an **unacceptable** restriction:

**Class 9:** *Apparatus for the reproduction of sound, namely iPods.*

For further guidance on the use of trade marks in lists of goods and services, see [paragraph 4.3.5](#).

#### 5.3.2.2 Territorial restrictions

**Territorial restrictions** contradicting the unitary nature of an EUTM are not allowed.

Example of an **unacceptable** request:

**Class 7:** *Washing machines, only for sale in France.*

This example would be in contradiction to the principle of free movement of goods and uniform protection throughout the entire area of the European Union referred to in Article 28 of the Treaty on the Functioning of the European Union.

Territorial amendments that do not change the scope of protection, for example, *clothing made in Vietnam*, may be acceptable. See also [paragraph 5.3.3.1 Amendments with territorial references](#).

Restrictions concerning the **origin** of goods are, in principle, acceptable, and, under certain circumstances, such as in relation to geographical indications (GIs), might even be necessary. For further guidance on restrictions required on the grounds of [Article 7\(1\)\(j\) to \(l\) EUTMR](#), see the Guidelines, [Part B, Examination, Section 4, Absolute Grounds for Refusal](#), and on GIs in lists of goods and services, see [paragraph 4.3.6](#).

#### 5.3.2.3 Ambiguity due to regulations

Restrictions that are **ambiguous** regarding the different national regulatory regimes across the European Union will not be accepted.

Example of an **unacceptable** restriction:

**Class 5:** *Medicines, only on prescription.*

This example would be considered to go against the judgment of 08/11/2013, [T-536/10, Premeno](#), EU:T:2013:586. In particular, the criterion mentioned cannot be accepted due to the lack of uniform rules governing sales of medicines requiring prescription within the EU, as explained in paragraphs 31-32 and 47 of said judgment.

#### 5.3.2.4 Clarity and precision

Restrictions must be **clear and precise**.

It should be clear which goods or services are excluded by the restriction and which will remain in the list of goods and services. Restrictions that appear completely

nonsensical within the context of the current list of goods and services will not be allowed.

Examples of **unacceptable** nonsensical restrictions:

**Class 16:** *Typewriters, only related to financial services.*

Where there is no possibility that the proposed limited use can be assured on the market, or where the proposed remaining scope of protection is blurred by a limitation that cannot be clearly linked to an existing or a potential market subcategory of the goods or services, the Office will raise an objection.

Example of an **unacceptable** restriction where the goods do **not possess such characteristics**:

**Class 31:** *Oranges, except smart oranges.*

The fresh fruit listed in the original indication will not cover any types of smart goods. Emphasising this fact by submitting such a disclaimer will not add relevant information to the term, and therefore has no effect on the current scope of protection.

Examples of **unacceptable** restrictions where the **remaining scope of protection** cannot be exactly determined:

**Class 7:** *Machines, in particular bulldozers.*

An unclear and imprecise term is not clarified or specified by simply mentioning an example of what it could cover; the term *machines* lacks clarity and precision, and merely giving examples of what this broad term may cover does not make it acceptable.

Using the expressions ‘including’, ‘in particular’, ‘for example’ or ‘such as’, as well as ‘included in this class’ or ‘not included in other classes’, **does not constitute a valid restriction** or specification of the preceding goods or services. For further information see [paragraph 4.2.3](#).

#### 5.3.2.5 Subjectivity

Restrictions that involve **subjective characteristics** will not be accepted.

Examples of **unacceptable** restrictions:

**Class 12:** *Luxury cars*

**Class 29:** *Tasty fruit*

**Class 33:** *Expensive wine.*

#### 5.3.2.6 Targeted public

Restrictions specifying or excluding a part of the public can only be accepted if they are **relevant** to the goods or services in question, and if the scope of protection remains **clear and precise**.

Examples of **acceptable** restrictions:

**Class 25:** *Clothing, except clothing for children*

**Class 41:** *Education for the visually impaired.*

Examples of **unacceptable** restrictions:

**Class 28:** *Roller skates, exclusively designed for surfers*

**Class 45:** *Legal services, not provided to hairdressers.*

#### 5.3.2.7 Intended use or purpose

Restrictions asking to specify or exclude the intended use or purpose of the goods or services can only be accepted if they are **relevant** to the goods or services in question and change their nature, and if the scope of protection remains **clear and precise**.

Examples of **acceptable** restrictions:

**Class 9:** *Operating systems, except operating systems for mobile phones*

**Class 39:** *Collection of domestic waste for recycling purposes.*

Examples of **unacceptable** restrictions:

**Class 16:** *Books, only for use with lamps*

**Class 42:** *Scientific research services, not for the purpose of social networking.*

#### 5.3.2.8 Restrictions specifying subject matter

Restrictions specifying or excluding subject matter can only be accepted if they are **relevant** to the goods or services in question and change their nature, and if the scope of protection remains **clear and precise**. This is in principle only possible for goods or services that can have content. Previous comments on the generic use of registered **trade marks** in the description of goods or services also apply.

Examples of **acceptable** restrictions:

**Class 9:** *CDs, recorded with music*

**Class 9:** *MP3 files, all containing jazz*

**Class 16:** *Printed comics, all related to science fiction*

**Class 41:** *Entertainment conventions, relating to role-playing games*

**Class 41:** *Musical concert services for the music of Beethoven.*

#### 5.3.3 Wording of amendments

An amendment is seen as a means to exemplify some goods or services, without changing the scope of protection or affecting the nature of the goods or services.

An amendment can follow one or several of the following approaches, provided they do not contradict each other:

1. **exemplifying items already covered** by the current scope;
2. **removal of items still covered** by the remaining scope;

3. **specification** of a **characteristic**;
4. **exclusion** of a **characteristic**.

Examples of valid amendments (in Class 30):

1. **Inclusion of items already covered:** *Sweets, in particular flavoured with strawberry and apricot flavour*. Since the scope of protection is *sweets* in general, highlighting possible characteristics by introducing some examples does not change the initial scope of protection.
2. **Removal of items still covered:** *Sweets, in particular flavoured with strawberry*. Despite deleting the example from the wording, it will implicitly remain covered by the broader term – the scope of protection remains the same.
3. **Specification:** *Sweets flavoured with strawberry*. Since strawberry-flavoured sweets are not a recognisable subcategory of confectionery nor a specific market sector, and since the description of the characteristics of sweets will not change the nature of these goods, the specification will be understood as an amendment.
4. **Exclusion:** *Sweets, not flavoured with strawberry*. Similarly, since strawberry-flavoured sweets are not a recognisable subcategory of confectionery nor a specific market sector, and since excluding some characteristics of sweets will not change the nature of these goods, the exclusion will be understood as an amendment.

An amendment must be **clear and precise** in order to be acceptable.

If excluding specific characteristics does not allow the scope of protection of the remaining goods or services to be understood with clarity and precision, the exclusion must be rejected.

Amendments specifying subcategories that may not be contained within the relevant class will be dealt with as follows.

Examples of **acceptable** amendments:

**Class 5:** *Diagnostic preparations, except for scientific use*.

Although *diagnostic preparations* can be found both in Class 1 and Class 5, Class 5 would only cover those for medical or veterinary purposes. *Diagnostic preparations for scientific use* would be proper to Class 1. The exclusion of the subcategory only clarifies the scope of the goods in Class 5. Even if this would not be a restriction, as it does not change the scope of protection, it can be accepted as an amendment as it exemplifies what is not covered.

**Class 7:** *Milling machines, except for dental purposes*.

Similarly, although *milling machines* could indeed also be used by dental technicians, such goods would not be proper to Class 7 but instead would be proper to Class 10. The exclusion of the subcategory only clarifies the scope of the goods in Class 7. Even if this would not be a restriction, as it does not change the scope of protection, it can be accepted as an amendment as it exemplifies what is not covered.

Example of an **unacceptable** exclusion:

**Class 35:** *Services of direct-mail campaigns and the issue of postage stamps provided they are not connected with a post office* does not allow the remaining goods and services to be understood with clarity and precision (12/02/2004, [C-363/99](#), Postkantoor, EU:C:2004:86, § 18, 115).

#### 5.3.3.1 Amendments with territorial references

Amendments relating to the **origin** of goods are, in principle, acceptable.

Example of an **acceptable** amendment indicating origin:

**Class 25:** *Clothing made in Vietnam*.

Such amendments are acceptable from the perspective of the examination of classification, as they do not broaden the scope of protection. However, the application may become subject to other objections (e.g. under [Article 7\(1\)\(g\) EUTMR](#)).

#### 5.3.3.2 Amendments specifying theme

Amendments specifying or excluding theme can only be accepted if they are **relevant** to the goods or services in question, and if the scope of protection remains **clear and precise**. This is in principle only possible for goods or services which do not have content. See also [paragraph 5.3.2.8 Restrictions specifying subject matter](#).

Examples of **acceptable** amendments:

**Class 25:** *T-shirts, bearing the image of Marilyn Monroe*

**Class 16:** *Pen cases with pictures of cartoon characters*

**Class 21:** *Mugs, showing pictures of Paris*.

#### 5.3.4 Influence of punctuation on restrictions and amendments

**Punctuation** also plays an important role in determining the scope of a restriction or amendment, as explained in [paragraph 4.2.5](#). This is especially important in connection with formulations such as ‘*all the aforementioned goods except for use in connection with [...]*’ or ‘*the aforementioned services exclusively related to [...]*’:

- Thus, a restriction in Class 9 reading *operating systems; text processing applications; games software; all the aforementioned goods for the sole use with tablet computers* will be interpreted as intending to **limit all these goods, equally due to the use of a semicolon** separating the specification from the rest of the list.
- However, a restriction in Class 9 reading *operating systems; text processing applications; games software, all the aforementioned goods for the sole use with tablet computers* will be interpreted as limiting only the use of games software, since, if **separated with a comma, the specification merely involves the last preceding term** delimited by a semicolon.

A request to add ‘*all the aforementioned goods, excluding [...]*’ or ‘*all the previously mentioned services, only with regard to [...]*’ at the end of the specification within a

class and separated by a semicolon will be interpreted as referring only to those preceding goods or services to which such an exclusion can reasonably apply, and will therefore be accepted as long as it can reasonably be applied to at least one good or service it refers to in that class. At the same time the criteria mentioned under [paragraph 5.3.1](#) need to be observed.

#### 5.3.5 Provisions for implementation

Should one part of a restriction or an amendment request be acceptable, and another not, the restriction will be objected to in its entirety. The Office will inform the applicant and set a time limit of 2 months for remedying deficiencies. If the deficiencies are not remedied within the given time limit, the restriction or amendment request will be refused in its entirety, and the proceedings will then continue on the basis of the original list of goods and services.

For information on the language of the request, see [the Guidelines, Part B, Examination, Section 1, Proceedings, paragraphs 5](#) and [5.1.1](#).

#### 5.3.6 Interpretation going beyond the general criteria

Restrictions and amendments need to be taken into account in the context of the proceedings in which they are requested.

Depending on the stage of proceedings, various additional principles and rules based on specific case-law might need to be followed.

For more detailed information on different proceedings, each respective part of the Guidelines should be consulted as appropriate – [Part B, Examination, Section 4, Absolute Grounds for Refusal, Chapter 10, Trade marks in Conflict with Geographical Indications \(Article 7\(1\)\(j\) EUTMR\)](#); [Part C, Opposition, Section 1, Opposition Proceedings](#), and [Section 2, Double Identity and Likelihood of Confusion, Chapter 1, General Principles](#); [Part E: Register Operations, Section 1, Changes in a Registration](#), and [Section 2: Conversion](#); and [Part M, International Marks](#).

## 5.4 Addition of classes

Under the provisions of [Article 49\(2\) EUTMR](#), it is possible to add a class or classes to an application, but only where the goods or services detailed in the original application were clearly included in the wrong class or when the goods or services have been clarified and need to be classified in other class(es).

For example, the original list of goods in Class 32 reads *non-alcoholic beverages including mineral water, fruit juices and tea*.

Since the natural class for *tea* is Class 30, the applicant will be requested to transfer the term to Class 30, even if this class was not listed in the original application. If the applicant agrees, the application will then cover these goods in Classes 30 and 32.

When transferring a term from one class to another, the scope of protection originally applied for also needs to be taken into account. In the example above, transferring *tea* to Class 5 (as *medicinal tea*) would not be possible as this would mean an unacceptable broadening of the original scope of protection. The original list of goods in Class 32 only includes *non-alcoholic beverages* without medicinal properties, so these goods do not therefore cover *medicinal tea*.

When classes are added, additional fees may be payable and the applicant must be informed accordingly.

## 5.5 Timing of objections

Classification objections should be raised as early as possible during the examination process, before publishing the application. As a general rule, it is not Office practice to reassess the classification of an application after publication.

There are, however, occasions when raising a late objection is justified in order to avoid manifest errors of law or assessment, such as when the error is clearly against the provisions of [Article 33 EUTMR](#) and could prevent competent authorities or economic operators from identifying competition/determining the exact scope of protection.

Thus, in accordance with [Article 44\(3\) EUTMR](#), where the publication of the application contains an error attributable to the Office, the Office will correct the error and publish the correction of its own motion or at the request of the applicant.

[Article 46\(2\) EUTMR](#) and Articles [2](#) to [10](#) EUTMDR apply *mutatis mutandis* where the correction concerns the list of goods or services of the mark.

## 6 Annex

### 6.1 Introduction

When classifying goods and services, the general principles of the Nice Classification must be applied.

The purpose of this Annex is to clarify the classification of certain problematic terms. It also provides notes on classification practice (including words or phrases that should not be used).

The Office's classification database, the HDB, is available through TMclass at <http://tmclass.tmdn.org>. The Goods and Services Builder can be found at <https://euipo.europa.eu/ohimportal/en/gsbuilder>.

### 6.2 Accessories for vehicles

If the list reads *vehicles; cars; parts, fittings, components and accessories for all the aforementioned goods* in Class 12, it will be accepted. However, parts, fittings, components and accessories for vehicles and cars that are not proper to Class 12, such as, for instance, *car air fresheners* (Class 5), *aircraft engines* (Class 7), *bicycle helmets* (Class 9), *car radios* (Class 9), *furniture for caravans* (Class 20), *car mats* (Class 27), will not be covered by that specification. If protection is sought for parts, fittings, components and accessories for vehicles and cars that are not proper to Class 12, these goods need to be specified separately, and applied for in the proper class or classes.

The term accessories for vehicles may be accepted in relation to services as long as there is a clearly recognisable market sector for that specification. For instance, if the list reads *retail of cars, and parts, fittings, components and accessories for the aforementioned goods* in Class 35, or *retail of bicycles, and parts, fittings, components and accessories for the aforementioned goods* in Class 35, it will be accepted, since these specific sectors are well defined on the market.

### 6.3 Advertising services

In principle, advertising services belong to Class 35. The main entries on advertising services in the list of services in the Nice Classification are:

- *advertising*
- *radio advertising*
- *radio commercials*
- *television advertising*
- *television commercials*



- *layout services for advertising purposes*
- *publication of publicity texts*
- *production of advertising films.*

These entries cover the design of advertising material and production of commercials for all kinds of media, as they are services that will be provided by advertising agencies.

## **6.4 Air freshening and perfuming preparations**

See [6.49 Perfuming and air freshening preparations](#) on page 331.

## **6.5 Amusement apparatus and electronic games**

Following changes to the Nice Classification on 1 January 2012 (10th edition), all *games* (whether electronic or not) are classified in Class 28.

These are shown in the alphabetical list as follows:

- *games (Apparatus for-)*
- *video game machines*
- *arcade video game machines.*

Most of these Class 28 devices come loaded with the games. However, if the games are not loaded on the devices, they will be recorded on data carriers or will be downloadable. In such cases, the games are considered to be game programs especially adapted for use with gaming devices; they will therefore be classified in Class 9.

See also [Computer games](#).

## **6.6 Assembly services**

These services in Class 40 cover the aspect of made-to-order manufacturing processes where several components are put together and interconnected to form finished or semi-finished goods.

Assembly services in Class 37 can only refer to the installation of goods and must be specified in more detail to that effect.

Note that the assembly of ready-built houses will be understood as construction services and therefore will only be correct in Class 37.

See also [Manufacturing services](#).

## **6.7 Association services or services provided by an association to its members**

These, and similar terms, are too unclear and imprecise to be acceptable. The type, or scope, of the service provided needs to be mentioned.

Examples of acceptable specifications:

Class 35: *Association services in the nature of business administration services.*

Class 45: *Services provided by an association to its members in the form of legal services.*

See also [Charitable services](#).

## **6.8 Beauty apparatus**

Class 7: *Sprayers (machines) for applying artificial sun tanning preparations.*

Class 8: *Hand-operated instruments/tools for beauty purposes.*

*Tattooing needles/apparatus.*

*Depilatory apparatus (electric and non-electric).*

*Laser hair removal apparatus.*

*Photoepilation apparatus.*

Class 10: *Massage apparatus.*

*Microdermabrasion apparatus.*

*Apparatus for the treatment of cellulite.*

*Lasers for cosmetic beauty treatments.*

Class 11: *Ultra-violet ray lamps for cosmetic purposes.*

*Sun beds.*

*Steam apparatus for cleaning the skin.*

Class 21: *Cosmetic brushes and applicators.*

## **6.9 Blogs (provision of -)**

The term *provision of blogs* on its own is analogous to *provision of information*, and as such the term lacks clarity and precision. The subject matter of the blog must be specified, and the term classified accordingly. See [paragraph 6.57 Providing information](#).

Examples of acceptable specifications that define the subject matter of the information provided via a blog:

Class 35: *Providing corporate blogs*

Class 39: *Providing travel blogs*

Class 41: *Providing educational blogs*

Class 43: *Providing culinary art blogs*

Services that allow users to communicate by blogs, or to host them, will be classified according to the nature of the services provided:

Class 38: *Communication by online blogs*

Class 38: *Providing access to online blogs*

Class 41: *Writing services of blogs*

Class 42: *Hosting of online blogs*

Class 42: *Creation and maintenance of software for blogs*

## **6.10 Bringing together of services**

See [Ordering of services](#) and [Retail and wholesale services](#).

## **6.11 Broadcasting and/or transmission services**

These services are proper to Class 38; both mean the same thing. The services provided in this area only cover the provision of the means of communication (e.g. the provision of a network of fibre-optic cables; the provision of broadcasts or transmissions via geostationary satellite transmission facilities; the rental of communications apparatus and systems). Class 38 does **not** cover any programmes, advertising, information or advice that may be transmitted by means of telecommunications or broadcasting technology. Those services would remain in the appropriate classes.

## **6.12 Brokerage services**

These are services provided by an individual or company who arranges transactions between a buyer and a seller. The broker may never see the goods or services in question.

As most transactions arranged by a broker involve the transfer of money, brokerage services as such are classified in Class 36, but there may be other specific brokerage services in other classes.

Examples of brokerage services:

Class 35: *Brokerage of name and address-based lists.*

Class 36: *[A large number of listings for] brokerage of futures, carbon offsets, real estate, bonds, securities and other financial-based items.*

Class 39: *Brokerage services relating to distribution, transport, and storage.*

### **6.13 Cases (and carrying bags)**

Cases (and bags) adapted to carry or transport the good they are intended to contain are, in principle, classified in the same class as the good they are adapted to carry. For instance *laptop bags* are proper to Class 9.

Cases and bags adapted to carry or transport goods should not be confused with non-adapted carrying bags, which are classified in Class 18, whilst disposable paper and plastic shopping bags and garbage bags are in Class 16, and laundry bags are in Class 22.

### **6.14 Charitable services**

This term is too unclear and imprecise to be accepted in any class without further qualification.

Charitable or humanitarian services are services provided for non-monetary benefit, serving the public interest or common good and are defined by the actual service offered. Therefore, they can be classified in any of the service classes, giving the correct definition.

Examples:

Class 35: *Charitable services, namely administration and general office work.*

Class 36: *The organisation of charitable collections; charitable fund raising.*

Class 38: *Telecommunications services for charitable purposes.*

Class 39: *Charitable services, namely ambulance transport.*

Class 40: *Charitable services, namely water treatment services.*

Class 41: *Charitable services, namely education and training.*

Class 42: *Charitable services, namely environmental protection services.*

Class 43: *Charitable services, namely providing food and drink and temporary accommodation.*

Class 44: *Charitable services, namely providing medical services.*

Class 45: *Providing clothing to needy persons [charitable services].*

### **6.15 Collection and storage services**

In the case of physical goods, both collection and storage services would be proper to Class 39. This class includes *transport* and *warehousing* in its listing. This would also include the collection and physical storage of data, whether in written form or recorded

on media (the Nice Classification has *physical storage of electronically stored data or documents* in Class 39).

*Office services* of electronically collecting, collating and manipulating data are all proper to Class 35.

*Storage of digital data* and *electronic data storage* are seen to be in analogy with *hosting services*, and so are proper to Class 42. *Cloud computing data storage services* are also proper to Class 42.

## 6.16 Consulting and advisory services

See [Providing information](#).

## 6.17 Commercial intermediation services

These are understood as third-party services of an agent for, or arranger of, a business contract between two trading parties for a commission or a fee. Since the principal activity would be aimed at closing trade agreements for others, such services are considered proper to Class 35.

However, it is important to distinguish between such commercial intermediation, which is strictly a business service, and the arranging of services for others as such, which would in general be seen as an integral part of the provision of those services themselves, and classified analogously.

## 6.18 Computer games and computer games apparatus

The terms *computer games* and *video games* are highly similar and are treated in the same way.

The dictionary reference for computer games is:

1. **(Noun)** 'any of various electronic games that are played by manipulating an input device in response to the graphics on the screen' (*Collins English Dictionary*).

Class 9 covers the software necessary for computer and video games, Class 28 covers the apparatus. If the terms *computer games* or *video games* are applied for as such, the class will define the nature of the goods covered.

See also [amusement apparatus and electronic games](#).

*Games* that are acceptable in Class 28 can come loaded as part of the software. For example, the following terms can all be accepted in Class 28:

- *arcade games*
- *arcade video machines*
- *computer game consoles*
- *games (Apparatus for -)*

- *hand held computer game devices*
- *video game machines.*

## **6.19 Curtains and blinds**

Blinds, in all their forms, can be used on windows both internally and externally. The classification of these goods depends upon the purpose of the goods and their material composition.

Curtains are normally used indoors and are classified similarly according to their material composition.

Examples of acceptable entries:

*Class 6: Outdoor blinds of metal*

*External metal blinds as part of a building for security purposes*

*Class 17: Curtains of asbestos (safety -).* (The material and purpose determine the classification.)

*Class 19: Blinds [outdoor] not of metal and not of textile.* (These goods are probably made of wood.)

*Class 20: Blinds (slatted indoor -)*

*Venetian and vertical window blinds*

*Indoor window blinds*

*Blinds (indoor window -) [shades] [furniture]*

*Curtains (bamboo -)*

*Paper blinds*

*Curtains (bead -) [for decoration]*

*Class 22: Outdoor blinds of textile.*

The vast majority of curtains will fall under Class 24, since most domestic curtains (sometimes referred to as 'drapes') are made of textiles or plastic.

Care should be taken with any references to curtain walling, or curtain walls. These refer to a type of construction technique relating to buildings, and the associated goods are building materials proper to Class 6 (for metal goods) or Class 19 (for non-metallic goods).

## **6.20 Custom manufacture/manufacturing for third parties**

See [Manufacturing services](#).

## 6.21 Customer services

Although many businesses have departments dedicated to *customer services*, this term on its own is considered lacking in clarity and precision and must be explained further. An example of an acceptable specification in Class 35 would be *providing advice and support to clients for sales purposes and to achieve customer loyalty*.

## 6.22 Data services

The term cannot be accepted on its own. It must be qualified.

The provision of data can be proper to several classes depending on the way in which the data is provided or on the nature of the data being provided. In each case the exact nature of the service being offered will need to be stated; *the provision of data* is not enough.

Examples of acceptable terms and their relevant classification:

Class 44: *Provision of data (information) relating to the use of pharmaceuticals*

(This would refer to the systemised provision of data that could only be interpreted by someone with specialised medical training.)

Class 45: *Provision and interpretation of data relating to animal tracking*.

(This would refer to services in relation to the relocation of a lost or stolen animal. If the data were for other purposes, the classification would be proper to other classes, for example, Class 42 for measuring or scientific reasons.)

See also [Providing information](#).

## 6.23 Design services

*Design services* are, as such, proper to Class 42.

*Design of advertising* and *design of brand names* are both proper to Class 35 as they are both advertising services.

Likewise, *landscape design*, *floral design*, *turf design* and *planning [design] of gardens* are proper to Class 44 as they are horticultural services.

## 6.24 Digital imaging services

The term *digital imaging services* was deleted from Class 41 in the 10th edition of the Nice Classification. Consequently, the term cannot be accepted in Class 41 without further details. This is because digital imaging can be classified in more than one class, depending on the field the service refers to: for example, medical, information technology or photography.

Examples of acceptable terms:

- *digital imaging (photo editing)* in Class 41;
- *medical imaging services* in Class 44;
- *rendering of computer graphics (digital imaging services)* in Class 42.

## 6.25 Downloadable goods and virtual goods

*Downloadable goods* refers to, inter alia, *publications, music, ring tones, pictures, photographs, films* or digitised information in general. Downloaded material is saved onto a memory unit or computer drive, telephone, tablet or smart device and can then be used independently of its source. All material that is downloadable is proper to Class 9.

*Virtual goods* are understood to be non-physical items for use in online and/or virtual environments.

The terms *downloadable goods* and *virtual goods* lack clarity and precision *per se* and must be specified further, whether in Class 9 as goods or in relation to retail services in Class 35. Acceptable examples would be *downloadable goods, namely, downloadable multimedia files* in Class 9 or *retail of virtual clothing* in Class 35.

The 12th Edition of the Nice Classification includes the term *downloadable digital files authenticated by non-fungible tokens [NFTs]* in Class 9. A *non-fungible token* can be understood as a cryptographic tool that uses a blockchain to create a unique, non-fungible digital asset which can be owned and traded.

In simple terms, NFTs are used as unique digital certificates to record an interest of some kind in relation to an item (such as the purported ownership of a digital artwork or a collectible). Like conventional certificates, NFTs in this form relate to something **other than themselves** which means that the term *NFTs* as such is ineffective for classification purposes without further specification about the item to which they relate. An acceptable example would be *downloadable digital art, authenticated by an NFT* in Class 9. On the other hand, *minting of NFTs* in Class 42 is acceptable given the nature of that service.

Services that relate to virtual or downloadable goods, as well as services provided online or in virtual environments, will be classified in line with the established principles of classification, which look at the underlying nature of the service, taking into account its impact **in the real world**. For instance, *transport services* in Class 39 involve moving a good or person from one physical location to another. A service that conveys an avatar from one location to another in a virtual reality game may emulate transport services but, in the real world, the purpose is entertainment, and it will be classified accordingly. Therefore, for example, *virtual transport services for gaming purposes* would be proper to Class 41.



## 6.26 Electricity and energy

The following is a guide to some of the goods and services related to electricity and energy in general.

Class 4: *Electrical energy* (although electrical energy is intangible, it is seen as analogous to other fuels, and so proper to Class 4)

Class 7: *Electrical generators*

Class 9: *Apparatus and instruments for conducting, switching, transforming, accumulating, regulating, or controlling electricity*

Class 11: *Heat generating apparatus*

Class 35: *Procurement of contracts concerning energy supply*

Class 36: *Brokerage of electricity* (see also [paragraph 6.12 Brokerage services](#))

Class 37: *Recharging of batteries*

Class 39: *Distribution of electricity*

Class 39: *Storage of electricity*

Class 40: *Generation of electricity*

Class 42: *Measuring services with regard to energy consumption.*

Note that the wording *retail or wholesale of energy or of electricity* will not be accepted. This is because energy and electricity in themselves cannot be the subjects of retail or wholesale services. Therefore, this term must be rephrased to reflect the services that need to be protected. For example, *electricity supply services* would be accepted in Class 39 or *the bringing together, for the benefit of others, of a variety of electricity provider services, enabling customers to conveniently compare and purchase those services* would be acceptable in Class 35. For more information on retail see [paragraph 6.60](#).

See also [paragraph 6.68 Solar power](#).

## 6.27 Electronic and electric apparatus

The terms *electronic and electric apparatus, devices or instruments* are insufficiently clear or precise for classification purposes; they are not acceptable in any goods class and should therefore be specified in more detail.

Specifications of *electronic and electric apparatus, devices or instruments*, such as the examples listed below, are also considered to lack clarity and precision:

- *electronic and electric apparatus for household purposes;*
- *electronic and electric apparatus for use in hairdresser salons;*
- *consumer electronics.*

## 6.28 Electronic cigarettes

*Electronic cigarettes, e-cigarettes or e-cigs* are - for classification purposes - acceptable only in Class 34, even if they are intended to serve a medical purpose. Non-electronic parts of these types of cigarettes, such as cartridges, atomisers or (aroma) substances, are also classified in Class 34.

Electronic parts, such as batteries and microcomputer-controlled circuits for electronic cigarettes, are not acceptable in these classes and belong - as usual - to Class 9.

## 6.29 Expert opinion services

The area of expertise has to be indicated for this type of service; classification will depend on the area of expertise indicated (see by analogy [Providing information](#)).

## 6.30 Facilities management services

The term *facilities management services* is acceptable in Class 37 because it can be understood as covering all the services necessary to support workspace and building infrastructure, such as cleaning, repair and maintenance services.

However, if the term is applied for in other classes, the branch of activity should be specified as the term would not be seen to naturally belong to other classes than Class 37.

## 6.31 Food additives and food supplements

*Food additives*, on the one hand, are substances added to food for non-nutritional purposes to improve the colour, flavour, preservation, etc. *Food additives* should in principle be classified according to the function group they belong to.

- *Composition/consistency*. Chemical and organic compositions used in the manufacture of food, such as binders, emulsifiers, stabilisers, thickeners, gelling agents or preservatives, are proper to Class 1. They are used to enhance or otherwise alter the consistency and durability of the food.
- *Colour*. Colourants in general are classified in Class 2.
- *Flavour*. Essential oils for enhancing flavour belong to Class 3.
- *Fillers/bulking agents for animal feed*. Class 31 contains complementary foodstuffs, or additional foods, used mostly as bulk fillers with little or no nutritional value. Examples of such goods would be corncobs, peanut hulls or cereal by-products.

*Food supplements*, on the other hand, are dietetic substances taken to supply nutrients to augment those provided by a regular diet. They are concentrated sources of nutrients (i.e. minerals and vitamins) or other substances with a nutritional or

physiological effect that are usually marketed in 'dose' form such as pills, tablets, capsules and liquids in measured quantities, and are therefore proper to Class 5.

*Veterinary, medical or nutritional supplements*, such as trace elements, antioxidants, amino acids, minerals or vitamins, are meant to sustain or improve the health of humans or animals and are therefore proper to Class 5.

### 6.32 Foodstuffs

Class 29 includes mainly foodstuffs of animal origin, as well as vegetables and other horticultural comestible products that are prepared for consumption or conservation. Class 30 includes mainly foodstuffs of plant origin, except fruit and vegetables, prepared for consumption or conservation, as well as auxiliaries intended to improve the flavour of food. Class 31 includes mainly agricultural and aquacultural products not having been subjected to any form of preparation for consumption; live animals and plants; and foodstuffs for animals.

Food for babies, medical meal replacements and dietetic food, adapted for medical or veterinary use, can be found only in Class 5. However, if not specifically adapted for medical or veterinary purposes, foodstuffs enhanced with or lacking a specific ingredient, such as *dairy-free chocolate, gluten-free bread, sugar-free sweets, calcium-fortified milk, sodium-free salt or vitamin/mineral-enriched breakfast cereals*, do not belong to Class 5 and are classified following the instructions in the Nice Classification general remarks.

### 6.33 Franchising

The verb 'to franchise' refers to the giving or selling of a franchise to another party. As a noun, 'franchise' means 'an authorisation granted to an individual or group to trade in a particular area for a stated period' (*Oxford English Dictionary*).

According to the general remarks in the Nice Classification (11th edition), 'Services rendered in the framework of franchising are in principle classified in the same class as the particular services provided by the franchisor (e.g. business advice relating to franchising (Cl. 35), financing services relating to franchising (Cl. 36), legal services relating to franchising (Cl. 45)).'

Without any more detailed specification, the Office will not accept the term *franchise service* or *franchising services* in Class 35. In order to be acceptable a clarification is required.

In order to classify the term properly, it is necessary to understand the actual nature of the service.

Services rendered by the franchisor **and** provided to the franchisee most commonly include business and marketing assistance (Class 35), financial management (Class 36), training (Class 41) and, to some extent, legal assistance (Class 45). This is reflected in the Nice Classification general remarks.

Examples of how the services provided by a restaurant franchisor could be classified:

Class 35: *Business assistance relating to starting and running a restaurant franchise*

Class 36: *Financial consultancy relating to franchising*

Class 45: *Licensing services relating to franchising.*

Example of how the services rendered in the context of a franchised restaurant could be classified:

Class 43: *Restaurant services; provision of food and drink.* (This would be the principal business activity of the applicant, and the subject of the franchise.)

It is not necessary to mention that such services are provided by a franchise.

However, services provided by a franchising agency offering to find proper third-party candidates for signing a franchising contract belong to Class 35 (by analogy to procurement of commercial contracts for others). Most services rendered by franchising agencies would fall into Class 35 as being business assistance.

### **6.34 Gadgets**

The term *gadgets (electronic or otherwise)* is considered unclear and imprecise in all classes and must be specified in more detail.

### **6.35 GPS systems - location, tracking and navigating**

*GPS* and *satellite navigation systems* (Class 9) provide location, tracking and navigating services, to provide the user with information.

The easiest way to classify these services is to divide them into those services that provide the telecommunications that run the services (Class 38) and those that provide information via a GPS device. The range of information provided goes beyond mere travel route information (Class 39). It can include information regarding restaurants and accommodation (Class 43), information regarding shopping outlets (Class 35) or telephone numbers (Class 38).

The use of GPS devices in relation to the movement of vehicles and people can also lead to classifications over a range of classes. Route planning services (Class 39) have already been mentioned. This classification would also extend to logistic or freight moving companies keeping track of their vehicles using the same devices.

GPS systems can also be used, in conjunction with other technology, to locate the source of a mobile telephone signal. If this is done as part of a telecommunication service it will be proper to Class 38. If, however, it is done as part of a criminal investigation service it will be proper to Class 45.

Other services can be associated with the services listed above. For example, the creation of maps for GPS systems is proper to Class 42. The downloadable

applications that run the service or provide alternative 'voices' are proper to Class 9. The retail services for providing the downloadable applications are proper to Class 35.

Examples of how these and other terms are classified:

*Class 35: Compilation and provision of commercial directory information regarding service providers for GPS navigation*

*Class 38: Satellite transmissions*

*Providing public subscribers directory information for GPS navigation*

*Providing access to general information supplied via satellite transmission*

*Telecommunications services for location and tracking of persons and objects*

*Tracking of mobile telephones via satellite signals*

*Location of mobile telephones via satellite signals*

*Providing access to GPS navigation services via satellite transmission*

*Satellite transmission of navigation data*

*Class 39: Providing GPS navigation services*

*Providing traffic information services via satellite transmission*

*Providing road information services via satellite transmission*

*Location services for logistics purposes of vehicles and goods*

*Tracking services for logistics purposes of vehicles and goods*

*Class 42: Providing weather information via satellite transmission*

*Creation of GPS maps*

*Class 45: Tracing and locating of missing persons via satellite transmission*

*Tracking of persons carrying electronic tagging devices*

*Security tracking services of vehicles*

*Security location services of vehicles.*

## **6.36 Hair styling**

Most *electric and non-electric hair styling apparatus* is classified in Class 8 (e.g. *electric hair curling irons; hair tongs* [non-electric hand implements] - these could also be gas operated; *crimping irons for the hair*, etc.). Exceptions are:

*Class 11: Hair dryers*

*Class 21: Combs and brushes* (non-electric and electric)

*Class 26: Hair curlers/rollers, other than hand implements* (e.g. clip-on, sponge or hook-and-loop fastener type).

### **6.37 Hire services**

See [Rental services](#).

### **6.38 Hotline services**

Also services of call centres. See [Providing information](#).

### **6.39 Humanitarian aid services**

Office practice on *humanitarian aid services* is the same as that on *charitable services*: the nature of the services must be specified (see [Charitable services](#)).

### **6.40 Internet services, online services**

The term *internet services* is not sufficiently clear and precise to be accepted in any class. It must be further defined.

A range of services, offered by individuals and businesses to other individuals and businesses, relate to the setting up, operation and servicing of websites. These are covered by appropriate entries in a number of classes.

An even wider range of services is offered to customers through the medium of telecommunications including via the internet. It is possible, over the internet, to shop, obtain banking advice, learn a new language, or listen to a 'local' radio station situated on the other side of the world.

The Nice Classification system generally applies regardless of whether the service is provided face-to-face, on dedicated premises, over a telephone or online via a database or website.

Examples of acceptable terms:

Class 35: *Advertising services provided over the internet*

Class 36: *On-line banking services*

Class 38: *Internet service provider services*

Class 41: *On-line gaming services*

Class 42: *Providing on-line support services for computer program users*

Class 45: *Online social networking services.*

## 6.41 Kits and sets

It is common in trade for certain goods to be sold in groups of more than one item. If the items are all the same - for example, a pack of three toothbrushes - then the classification is simple. However, sometimes the collection of goods could be the component parts of another item, or have a function that is not defined by the individual goods. These groups of goods sometimes have collective names such as 'kit' or 'set'. These small words can have a great impact on (1) their acceptability as a collection of goods and (2) their appropriate classification.

A 'kit' can mean either:

1. a set of parts ready to be made into something (e.g. a kit for a model plane), or
2. a set of tools or equipment that is to be used for a particular purpose (e.g. a first-aid kit).

A 'set' is a number of articles that are thought of as a group. This may or may not have a defined number (e.g. a set of keys, a set of saucepans, a set of golf clubs, a cutlery set).

Kits or sets that are comprised of goods that might not belong to only one single class of the Nice Classification can be accepted by the Office if the type of the kit or set is indicated and is commonly available on the market.

In general, a kit or set is classified according to its function or purpose. When the kit or set is comprised of goods that are classified in more than one class, it will be classified by either what the kit or set is going to be used for, or, if something is to be constructed from its components, what the finished article will be.

- If the **unspecified** kit or set is a combination of a number of components **around a theme** and also **commonly available on the market**, it will be classified according to the class in which **the majority of the individual components** are classified or to which the **primary components** belong. An example of this would be *sewing kits*; this might be comprised of different items which could also belong to other classes, but will be accepted as such in Class 26.
- If the **unspecified** kit is for the **purpose of making a single object**, it will be classified according to the item that it is intended to make. For example, *kits of parts for assembly into articles of furniture* will be accepted in Class 20, to which *furniture* belongs, and *plastic model kits for making toy vehicles* will be classified in Class 28, to which *toy vehicles* belong.
- If the goods making up the kit cannot be ascertained, the term will be seen as lacking clarity and precision and must be objected to. For example, *do-it-yourself kits* in Class 7 will not be accepted.

There is no need for the applicant to indicate the particular components of a kit or set. In fact, a kit or set around a theme that is commonly available on the market, or that is for the purpose of making a single object, is in itself sufficiently clear and precise to determine its scope of protection and the class to which it belongs.

However, if a kit or set is indicated as a mere group of components that would otherwise belong to different classes, and if customers would not expect these goods to be bundled together as common practice on the market, then each of the components should be separated and classified according to their function or purpose, and according to the principles of the Nice Classification. For example, the term *tool kits comprising hand saws, power-driven saws, and carpenter's levels* in Class 8 will be objected to. The individual components should be classified in individual classes as follows: *hand saws as part of tool kits* (Class 8), *power-driven saws as part of tool kits* (Class 7) and *carpenter's levels as part of tool kits* (Class 9).

Examples of acceptable terms:

Class 3: *Cosmetic kits*.

Class 5: *First aid kits*.

Class 8: *Manicure sets*.

Class 9: *Hands-free kits for phones*.

Class 16: *Drawing sets*.

Class 21: *Portable cooking kits for outdoor use*.

## 6.42 Leasing

According to the general remarks in the Nice Classification (11th edition), 'Leasing services are analogous to rental services and therefore should be classified in the same way. However, hire- or lease-purchase financing is classified in Cl. 36 as a financial service.'

Note that, although the definition of *leasing* might differ across languages, for the sake of consistency it will be interpreted as indicated above, based on the meaning of the term *leasing* in English.

See also [Rental services](#).

## 6.43 Mail order

See [Retail and wholesale services](#).

## 6.44 Manuals (for computers, etc.)

Electronic items such as computers, printers, photocopiers and other electronic items are often delivered as new goods to the customer with a list of operating instructions. The instructions can be in paper (printed) format or in an electronic format, such as a recording on a disc, or as a downloadable or non-downloadable document available on the manufacturer's website.



Examples:

Class 9: *Manuals in electronic format for computer software*

Class 16: *Printed manuals for computer software.*

## 6.45 Manufacturing services

Manufacturing is only seen as a service when it is undertaken for third parties. Custom manufacturing of certain single, 'one-off', goods for third parties, for example a sailing boat or a sports car, by a specialist in that field would be proper to Class 40. Custom construction of, for example, made-to-measure kitchen units would be included in Class 40, but their installation would be proper to Class 37.

See also [Assembly services](#).

## 6.46 News services

The term *news services* is acceptable in Class 41 by analogy with *news programme services for radio or television* or *news reporting services*; if it is applied for in other classes, it will need to be specified.

*News agency services* are proper to Class 38. They are essentially a hub or collection point through which journalists and others can file and obtain newsworthy materials (in the form of stories, script or photographs). They do not perform any other function such as editing or verification services.

Examples:

Class 35: *News clipping services.*

Class 38: *News broadcasting services.*

Class 40: *Printing of newspapers.*

Class 41: *Presentation of news (programmes).*

*Publication of news.*

*Editing of news.*

As far as electronic news publications are concerned, *downloadable news pod casts*, *news clips*, *news items*, *news publications*, etc. are all goods that are proper to Class 9.

## 6.47 Online services

See [Internet services](#).

## **6.48 Ordering of services**

*The ordering of goods/services for others* can be accepted in Class 35 as a business service/office function. There are individuals and companies that offer services providing solutions to a variety of problems on behalf of others. For example, if you need a leaking tap to be fixed, the intermediary (service provider) will arrange the services of a plumber for you. This classification is analogous with the Nice Classification entry *procurement of services for others [purchasing goods and services for other business]*.

## **6.49 Perfuming and air freshening preparations**

There are preparations, and associated apparatus, that serve merely to mask unpleasant smells (perfume) or chemically 'wrap up' and remove unpleasant odours (deodorisers). They are properly classified as follows:

Class 3: *Air fragranting preparations*

*Incense*

*Potpourris [fragrances]*

*Sachets for perfuming linen*

*Scented wood*

*Fumigation preparations [perfumes]*

*Room sprays*

Class 5: *Air deodorising preparations*

*Air purifying preparations*

Class 11: *Air deodorising apparatus*

Class 21: *Perfume burners*

*Vaporizers for perfume sold empty.*

Other goods that may release pleasant odours include *perfumed candles* (proper to Class 4 as the release of perfume is a secondary characteristic) and *perfumed drawer liners* (proper to Class 16 as they are analogous to *packaging material* and usually made of paper).

## **6.50 Personal and social services rendered by others to meet the needs of individuals**

The general indication *personal and social services rendered by others to meet the needs of individuals* is not sufficiently clear and precise and will not be accepted by the Office. See also [paragraph 4.3.1](#).

The applicant needs to make the wording more specific.

Many personal and social services are classifiable but are proper to classes other than Class 45.

Examples:

Class 36: *Personal insurance services* (such as life assurance)

Class 41: *Personal tuition*

Class 44: *Personal medical services*

Class 45: *Personal body guarding*

*Consultancy services relating to personal appearance*

*Personal shopping services*

*Concierge services.*

## **6.51 Personal assistant services**

This term lacks clarity and precision and needs to be explained further. Personal assistants offer assistance in managing their employer's personal and/or business life by taking over specific tasks, which, however, are not clearly defined. The activities involved could cover services proper to various different classes such as:

- *Appointment scheduling services* (Class 35);
- *Telephone answering* (Class 35);
- *Personal trainer services [fitness training]* (Class 41);
- *Personal reminder services in the area of upcoming important dates and events* (Class 45);
- *Personal fashion consulting services* (Class 45);
- *Dog walking services* (Class 45).

A similar assessment will be applied to *lifestyle management* as this is also considered to lack clarity and precision for classification purposes.

## **6.52 Precious metal goods**

The general indication *goods of precious metals or coated therewith, not included in other classes* in Class 14 is not sufficiently clear and precise and will not be accepted by the Office (see also [paragraph 4.3.1](#)). The applicant needs to make the wording of the term more specific.

Caution needs to be applied when classifying goods made from precious metals.

Historically, virtually all goods made from, or coated with, precious metals were grouped together in Class 14. It was considered that the material had an influence on why the goods were bought and that in turn determined where the goods were classified.

Since 1 January 2007, many goods that would have been in Class 14 have been reclassified. This reclassification of the goods is based on their function rather than the material from which they are made.

Examples of goods classified according to their function or purpose:

Class 8: *Cutlery of precious metal*

Class 16: *Pen nibs of gold*

Class 21: *Teapots of precious metal*

Class 34: *Cigarette and cigar boxes made of precious metals.*

### **6.53 Protective clothing**

If the **primary** function of items that are worn (or sometimes carried) is the prevention of serious and/or permanent injury or death, or protection against, for example, contact with or exposure to extremes of temperature, chemicals, radiation, fire, or environmental or atmospheric hazards, then those goods will be proper to Class 9.

Examples of such protective goods include hard hats worn on building sites, and helmets worn by security guards, horse riders, motorcyclists, and American football players. Bullet-proof vests, metal toe-capped shoes, fireproof jackets and metal butchers' gloves are further examples: they are not clothing as such. Aprons, smocks and overalls merely protect against stains and dirt and are not proper to Class 9 but to Class 25 as general clothing. Protective sporting articles (except helmets) are proper to Class 28 as none of them protect against loss of life or limb.

### **6.54 Providing a website**

*Providing a website* is understood as being analogous to providing information, and is classified according to the subject matter to which the website is dedicated. The applicant has to define this subject matter and classify accordingly, unless it is specified that the services refer to website development or the hosting of the content (Class 42).

See also [Providing information](#).

### **6.55 Providing an online platform**

These services are proper to Class 42 since they are understood to refer to the provision of a computing platform. They could also refer to the provision of an operating system, a browser, an application, a virtual machine or cloud - all being software solutions.

## 6.56 Providing downloadable content

*Provision of downloadable content* is classified according to the nature of the content (see [Providing information](#)); the wording of the term should make this clear.

Class 41 examples:

- *providing downloadable electronic books* (Class 41);
- *provision of downloadable electronic games* (Class 41);
- *providing downloadable digital music* (Class 41).

Class 42 examples:

- *providing downloadable applications* (Class 42);
- *providing downloadable computer operating systems* (Class 42).

As with the term *provision of information*, *provision of downloadable content* without further specification lacks clarity and precision.

The retail/wholesale of downloadable content is different – this would refer to bringing together a variety of downloadable content for the benefit of third parties, making it available to users to select from and purchase.

Class 35 examples:

- *retail services in relation to downloadable electronic publications;*
- *retail services in relation to downloadable music files;*
- *wholesale services in relation to downloadable computer software.*

## 6.57 Providing information

According to the general remarks in the Nice Classification (11th edition), ‘Services that provide advice, information or consultation are in principle classified in the same classes as the services that correspond to the subject matter of the advice, information or consultation, e.g., transportation consultancy (Cl. 39), business management consultancy (Cl. 35), financial consultancy (Cl. 36), beauty consultancy (Cl. 44).’

The applicant has to define the subject matter of *providing information*, and classify it accordingly. The fact that information is provided by electronic means (e.g. telephone, computer – email, website or blog) does not affect the classification of these services.

*Providing advice, consultancy and information with regard to the aforesaid services* at the end of the indication of any service class will be accepted.

## 6.58 Rental services

According to the Nice Classification general remarks (11th edition), ‘Rental services are in principle classified in the same classes as the services provided by means of the rented objects (e.g., Rental of telephones, covered by Cl. 38).’

The same principle applies to *leasing services*, which can be found in the HDB in all of the service classes.

## 6.59 Reservation services and booking services

*Reservation services* and *booking services* are services that relate to different areas of activities, and are classified according to their subject matter in different classes. Therefore, the terms *reservation services* and/or *booking services* on their own are not considered clear and precise. The services to which the reservation and/or booking is made should therefore be specified.

If the *reservation services* and/or *booking services* concern travel, for example, *ticket booking services for travel* or *tour reservation services*, the terms are proper to Class 39. Likewise, *ticket reservation and booking services for education, entertainment and sports activities and events* are classified in Class 41.

Consequently, *reservation services* and *booking services* will be classified in the same class as the services for which the reservation and/or booking is made.

Examples of acceptable terms:

Class 35: *Employment booking services for performing artists.*

Class 39: *Booking of seats for travel.*

Class 39: *Transport reservation.*

Class 41: *Booking of seats for shows.*

Class 41: *Ticket reservation for cultural events.*

Class 43: *Boarding house bookings.*

Class 43: *Hotel reservations.*

Class 43: *Reservation of restaurants.*

## 6.60 Retail and wholesale services

Retail is defined as '[t]he action or business of selling goods in relatively small quantities for use or consumption' (*Oxford English Dictionary*); this defines the scope of the services covered by the term 'retail services'.

There is an indication in the explanatory note to the listing of Class 35 in the Nice Classification that the term 'the bringing together, for the benefit of others, of a variety of goods (excluding the transport thereof), enabling customers to conveniently view and purchase those goods' is proper to Class 35. In accordance with this indication, *Retail services* are classified in Class 35.

However, as regards *retail services* or similar services in Class 35 relating to the sale of goods, such as wholesale services, mail order services and e-commerce services, the Office applies the judgment of 07/07/2005, [C-418/02](#), Praktiker, EU:C:2005:425: the

term *retail services* is only acceptable where the type of goods or services to be sold or brought together for the benefit of others is indicated with sufficient clarity and precision (see [paragraph 4.3](#)). The term *retail services of a supermarket* and, by extension, *retail services of a department store* and similar terms are not acceptable as the goods to be sold are not defined (01/12/2016, [T-775/15](#), Ferli, EU:T:2016:699).

The 11th edition of the Nice Classification includes *retail or wholesale services for pharmaceutical, veterinary and sanitary preparations and medical supplies*, which shows how these terms can be expressed.

Examples of categories of goods that do not fulfil the requirements of clarity and precision can be found under [paragraph 4.3.2](#).

The general indications of the class headings that are not acceptable (see [paragraph 4.3.1](#)) are also not acceptable for retail services for those same general indications. For example, the Office will not accept *retail services for machines*. However, *retail services in relation to agricultural machines* is sufficiently precise and therefore acceptable.

As regards ‘retail of services’ (i.e. *services that consist of the bringing together, for the benefit of others, of a variety of services, enabling consumers to conveniently compare and purchase those services*), the Court has held that these must also be worded with sufficient clarity and precision to allow the competent authorities and other economic operators to know what services the applicant intends to bring together (10/07/2014, [C-420/13](#), Netto Marken Discount, EU:C:2014:2069).

This decision confirms that the ‘bringing together of services’ is an activity that is entitled to protection. The Court placed greater emphasis on the importance of defining the services being brought together than on defining the action of ‘bringing together’ itself (thereby echoing its earlier judgment of 07/07/2005, [C-418/02](#), Praktiker, EU:C:2005:425).

Terms expressing this should satisfy two requirements. Firstly, they should include familiar terms (i.e. ‘bringing together’, ‘for the benefit of others ...’ or ‘enabling customers to compare and purchase ...’) in order to ‘frame’ the services being brought together and describe the actual retail activity itself. Secondly, the terms used to describe the services being brought together must be understood and accepted in their own right (e.g. legal services, broadcasting services, slimming club services).

In order to meet the fundamental requirements for clarity and precision under [Article 33\(2\) EUTMR](#), any claim to the retailing or ‘bringing together’ of services must be worded in this manner.

Examples that will be considered acceptable:

- *The bringing together, for the benefit of others, of a variety of legal services, enabling customers to conveniently compare and purchase those services*
- *The bringing together, for the benefit of others, of slimming club services, video on demand services, and detective agency services, enabling customers to conveniently compare and purchase those services*

- *The bringing together, for the benefit of others, of a variety of broadcasting services, enabling customers to conveniently compare and purchase those services.*

In the case of the bringing together of services, wordings including ‘retail services connected with ...’, ‘retail services connected with the sale of ...’ and ‘electronic shopping retail services connected with ...’ do not provide a clear distinction between the retailing of services and the provision of those services in their own right.

Examples that will not be accepted and will be subject to an objection:

- *Retail services connected with takeaway services*
- *Retail services connected with the sale of legal services*
- *Mail order retail services connected with the sale of detective agency services.*

The CJEU’s ruling is not to be interpreted as providing a means of obtaining duplicate protection for services intended to be provided in their own right (whether proper to Class 35 or elsewhere). Nor should it be perceived as an alternative means of providing protection for the advertising of one’s own services. Therefore, if an application covers ‘the bringing together for the benefit of others of telecommunication services, enabling customers to conveniently compare and purchase those services’, these services do not cover the actual provision of telecommunication services, which belongs to Class 38, but only the bringing together of a variety of telecommunication service providers so as to enable consumers to compare and purchase those services conveniently.

Finally, it is not sufficiently precise to specify the goods or services using terms such as ‘including’, ‘in particular’, ‘for example’ or ‘such as’, since all these terms mean, in principle, ‘for example’. They do not restrict the goods or services that follow. Consequently, the abovementioned terms should be replaced by ‘namely’ or ‘being’, as they do restrict the goods or services that follow.

## **6.61 Retail of pre-paid cards**

The term *retail of pre-paid cards* without a further specification lacks clarity and precision; the nature of the cards is not clear. Therefore, the exact market sector for which the cards are meant should be specified.

Examples of **acceptable** terms:

Class 35: *Retail of third-party pre-paid cards for the purchase of entertainment services*

Class 35: *Retail pre-paid cards for the purchase of clothing.*

## **6.62 Robots**

The term *robots* lacks clarity and precision; therefore, the nature of the goods has to be specified.

Examples of **acceptable** terms:



Class 7: *Industrial robots*

Class 9: *Humanoid robots with artificial intelligence for use in scientific research*

Class 10: *Surgical robots.*

### **6.63 Satellite tracking**

See [GPS systems - location, tracking and navigating](#).

### **6.64 Sets**

See [Kits and sets](#).

### **6.65 Smartwatches and activity bracelets**

The Nice Classification shows *smartwatches* in Class 9. These goods are seen as having the function more of communication devices than horological instruments; other similar additions in Class 9 are the terms *wearable activity trackers*, *connected bracelets [measuring instruments]* and *smartglasses*, all of which clearly show that the primary function and purpose of the goods dictate their classification.

### **6.66 Social networking services**

*Social networking services* is an acceptable term in Class 45. It would be seen as a personal service that includes the identification and introduction of like-minded people for social purposes.

There are other aspects of the *social networking* industry that could be proper to classes other than Class 45, for example:

Class 38: *The operation of chat room services*

*The provision of online forums.*

### **6.67 Software publishing**

*Software publishing* belongs to Class 41. A software publisher is a publishing company in the software industry that serves as an intermediary between the developer and the distributor. Publishing, according to its definition, includes *newspaper publishing* and *software publishing*.

## **6.68 Solar power**

Solar power is energy that is derived from the sun and converted into heat or electricity.

Goods relating to the generation and storage of electricity from solar energy are classified in Class 9.

Goods relating to the generation and storage of heat from solar energy are classified in Class 11.

Services relating to the generation of electricity from solar energy are classified in Class 40.

Class 9: *Photovoltaic cells*

*Solar panels, modules and cells*

Class 11: *Solar collectors for heating*

Class 40: *Production of energy.*

See [Electricity and energy](#).

## **6.69 Statistics**

Regardless of the subject matter, *compilation of statistics* is proper to Class 35 as it is analogous to 'compiling of data'.

Nevertheless, statistics have to be treated as information. Therefore, *providing statistics* will also be considered lacking clarity and precision unless the subject matter is defined. Consequently, the classification once again depends on the subject matter.

Examples:

Class 35: *Providing market research statistics.*

Class 39: *Providing statistics on traffic flow.*

Class 42: *Providing statistics with regard to rainfall.*

Other services connected with statistics may be classified differently and include:

Class 38: *Providing access to statistical data.*

Class 41: *Publication of statistics.*

Class 42: *Scientific analyses of research statistics.*

## **6.70 Storage services**

See [Collection and storage services](#).

## 6.71 Supply of ...

Care should be taken in accepting this term when it is used to qualify services.

It is acceptable in some circumstances, for example, *supply of electricity* in Class 39, where the term is often closely related to *distribution*. The same applies to the supply of other commodities such as *the supply of water* (Class 39).

The *supply of food* as such is not acceptable since the term is not clear and precise as different services could be implied that are classified in different classes; such as *retail of food* (Class 35), *transport and delivery of food* (Class 39) or *provision of food* (Class 43).

The term *catering services for the supply of meals* (in Class 43) is acceptable because the material being supplied, and the nature of the service, have both been given. The same applies to *supplying of meals for immediate consumption* (in Class 43) since *meals* is understood to be prepared food and is therefore classified in line with *provision of food* (in Class 43).

## 6.72 Systems

This is another term that can be too unclear or too imprecise to be accepted.

It can be accepted only when qualified in a clear and unambiguous way.

Examples of acceptable terms:

Class 7: *Exhaust systems*

Class 9: *Telecommunication systems*

*Computer systems*

*Alarm systems*

Class 16: *Filing systems*.

## 6.73 Tickets (for travel, entertainment, etc.)

A ticket is a 'promise to supply', in relation to a service or reservation service, the right to a service.

Examples:

Class 39: *Issuing of airplane tickets*

Class 41: *Ticket agency services (entertainment)*

Note that tickets are not seen as goods retailed in Class 35.

## 6.74 Tourist/Holiday services

The terms *tourist services*, *holiday services* as well as *tourist office services* are not sufficiently clear or precise, as they can relate to different areas of activity, and services belonging to different classes. The terms must be defined further.

Examples of **acceptable** terms:

Class 39: *Providing tourist travel information*

Class 43: *Tourist agency services for booking accommodation.*

## 6.75 Video games

See [Computer games](#).

## 6.76 Virtual environment

The term *providing a virtual environment* is neither sufficiently clear nor precise as it can relate to different areas of activities and classes. The term must be defined further.

Examples of acceptable terms:

Class 38: *Providing a virtual chatroom*

*Providing access to a virtual environment*

Class 42: *Hosting of a virtual environment*

*Maintenance of a virtual environment.*

## 6.77 Wellness and well-being services

The term *wellness services* is not sufficiently clear or precise, and therefore needs to be specified in more detail. This is because there is currently no definition of such services that would put them into one - and only one - class. Despite being a known market phenomenon, the interpretation of the scope of this service is not entirely clear and can differ from one enterprise to another.

Note that *wellness services provided in beauty salons* or similar indications will not render the term acceptable.

Examples of acceptable clarifications:

Class 41: *Instruction in exercise as wellness club services*

*Teaching of meditation as part of a wellness programme*

Class 44: *Wellness services for the purpose of beauty care*

*Health spa services for wellness*

*Relaxing massage in wellness centres*

*Class 45: Spiritual consultancy aimed at wellness.*

**GUIDELINES FOR EXAMINATION**

**EUROPEAN UNION**  
**INTELLECTUAL PROPERTY OFFICE**  
**(EUIPO)**

**Part B**

**Examination**

**Section 4**

***Absolute grounds for refusal***

## Table of Contents

<b>Chapter 1 General principles.....</b>	<b>345</b>
<b>Chapter 2 EUTM definition (Article 7(1)(a) EUTMR).....</b>	<b>361</b>
<b>Chapter 3 Non-distinctive trade marks (Article 7(1)(b) EUTMR).....</b>	<b>379</b>
<b>Chapter 4 Descriptive trade marks (Article 7(1)(c) EUTMR).....</b>	<b>465</b>
<b>Chapter 5 Customary signs or indications (Article 7(1)(d) EUTMR).....</b>	<b>522</b>
<b>Chapter 6 Shapes or Other Characteristics that Result from the Nature of the Goods, are Necessary to Obtain a Technical Result or give Substantial Value to the Goods (Article 7(1)(e) EUTMR).....</b>	<b>527</b>
<b>Chapter 7 Trade marks contrary to public policy or acceptable principles of morality (Article 7(1)(f) EUTMR).....</b>	<b>542</b>
<b>Chapter 8 Deceptive trade marks (Article 7(1)(g) EUTMR).....</b>	<b>559</b>
<b>Chapter 9 Trade Marks in conflict with flags and other symbols (Article 7(1)(h) and (i) EUTMR).....</b>	<b>586</b>
<b>Chapter 10 Trade Marks in Conflict with Geographical indications (Article 7(1)(j) EUTMR).....</b>	<b>606</b>
<b>Chapter 11 Trade marks in conflict with traditional terms for wines (Article 7(1)(k) EUTMR).....</b>	<b>661</b>
<b>Chapter 12 Trade marks in conflict with traditional specialities guaranteed (Article 7(1)(l) EUTMR).....</b>	<b>673</b>
<b>Chapter 13 Trade marks in conflict with earlier plant variety denominations (Article 7(1)(m) EUTMR).....</b>	<b>681</b>
<b>Chapter 14 Acquired distinctiveness through use (Article 7(3) EUTMR).</b>	<b>692</b>
<b>Chapter 15 European Union collective marks.....</b>	<b>711</b>
<b>Chapter 16 European Union certification marks.....</b>	<b>720</b>

***GUIDELINES FOR EXAMINATION OF  
EUROPEAN UNION TRADE MARKS***

***EUROPEAN UNION  
INTELLECTUAL PROPERTY OFFICE  
(EUIPO)***

***Part B***

***Examination***

***Section 4***

***Absolute grounds for refusal***

***Chapter 1***

***General principles***



## Table of Contents

<b>1 Reasoned Objection.....</b>	<b>347</b>
<b>2 Dialogue with the applicant.....</b>	<b>347</b>
<b>3 Decision.....</b>	<b>349</b>
<b>4 European criteria.....</b>	<b>349</b>
4.1 Languages.....	349
4.1.1 Glossary.....	349
4.1.2 Relevant languages in AG examination.....	350
4.2 The baseline.....	353
4.3 The relevant part of the EU.....	354
4.3.1 Relevant territory and objections based on EU national languages.....	354
4.3.2 Relevant territory and objections based on EU regional languages and non-EU languages.....	355
<b>5 Scope of Objections to the Goods and Services.....</b>	<b>356</b>
<b>6 Timing of Objections.....</b>	<b>359</b>
<b>7 Disclaimers.....</b>	<b>359</b>

## 1 Reasoned Objection

Any one of the grounds listed in [Article 7\(1\) EUTMR](#) is sufficient for the refusal of a European Union trade mark.

For the sake of sound administration and economy of proceedings, the Office will raise any objections to registration of the sign under [Article 7\(1\) EUTMR](#) **as soon as possible and preferably all at once**. This is particularly important in those cases where the applicant cannot overcome the objection by demonstrating that the sign has acquired distinctive character through use (for instance, when [Article 7\(1\)\(e\) EUTMR](#) is invoked).

Each of the grounds for refusal listed in [Article 7\(1\) EUTMR](#) is **independent** and must be examined separately. Therefore, when various absolute grounds for refusal are invoked, a reasoned objection will be issued, specifying the individual grounds for refusal and providing clear and distinct reasoning **for each ground**. Even when some grounds for refusal overlap, each ground for refusal must be reasoned in the light of the general interest underlying each of them.

For example, where a word mark is found to have a semantic meaning that gives rise to an objection under both [Article 7\(1\)\(b\) and \(c\) EUTMR](#), the notification of grounds for refusal should deal with each of those grounds in separate paragraphs. In such a case, it will be clearly indicated whether the lack of distinctiveness arises out of the same, or different, considerations from those that lead to the mark being deemed descriptive.

Occasionally, **arguments put forward by the applicant**, or a restriction (partial withdrawal) of the list of goods and services, will lead to the application of other grounds for refusal. In these cases, the party will always be given the opportunity to comment thereon.

## 2 Dialogue with the applicant

During examination proceedings, the Office will seek a dialogue with the applicant.

At all stages of the proceedings, the observations submitted by the applicant will be considered carefully.

The Office will likewise consider, of its own motion, new facts or arguments that plead in favour of acceptance of the mark. The application can only be refused if the Office is convinced that the objection is well founded at the point in time when the decision is taken.

If several grounds for refusal are raised, the applicant must overcome all of them, since a refusal can be based on a single ground for refusal (19/09/2002, [C-104/00 P](#), Companyline, EU:C:2002:506, § 28).

- No observations submitted by the applicant

Where the applicant has not submitted any observations, if the application is to be refused, the Office will send a refusal letter to the applicant, which will include the original reasoning and ground(s) of the objection letter.

- Observations submitted by the applicant  
If the applicant contests the reasons given in the original notification, the refusal will first provide the original reasoning given, and then address the applicant's arguments.

Where the Office needs to provide new facts or arguments to sustain a refusal, the applicant must be given the opportunity of commenting on these before a final decision is taken.

- Restriction of goods and services  
Where the applicant tries to overcome the objection by restricting the list of goods and services, it is possible that the restriction may give rise to a new ground for refusal, for example, deceptiveness in addition to descriptiveness. In this case, another objection letter will be issued to give the applicant the opportunity to comment on all the grounds for refusal found pertinent.

A specification of goods or services that is restricted by a condition that the goods or services do not possess a particular characteristic should not be accepted (12/02/2004, [C-363/99](#), Postkantoor, EU:C:2004:86, § 114). For example, in respect of the trade mark 'Theatre', a specification claiming '*books, except for books about theatre*' should not be accepted. By contrast, restrictions that are worded in a positive way are usually acceptable, such as '*books about Chemistry*'.

- Proof of acquired distinctiveness  
The applicant has the right to claim that its mark has acquired distinctiveness through use ([Article 7\(3\) EUTMR](#)) and to submit relevant proof thereof.

The applicant must make its claim under [Article 7\(3\) EUTMR](#) either together with the application or, **at the latest, in reply to the Office's first objection** ([Article 2\(2\) EUTMR](#)). The claim can no longer be made for the first time at the appeal stage ([Article 27\(3\)\(a\) EUTMDR](#)).

The claim of acquired distinctiveness through use can be made either as a **principal** claim or as a **subsidiary** one ([Article 2\(2\) EUTMR](#)). The applicant must, however, clearly and precisely specify the type of claim, either together with the application or, at the latest, in reply to the Office's first objection.

Where the applicant has made a **principal** claim, the Office will take **one** (single) decision both on the mark's inherent distinctiveness and, where there is no inherent distinctiveness, on the submission of acquired distinctiveness through use.

Where the applicant has made a **subsidiary** claim, the Office will take a **first** decision on the mark's inherent distinctiveness and then, once that decision (finding lack of inherent distinctiveness) has become final, the applicant will be invited to submit its evidence on acquired distinctiveness through use.

For further information on acquired distinctiveness through use, please see the Guidelines, [Part B, Examination, Section 4, Absolute grounds for refusal, Chapter 14, Acquired distinctiveness through use \(Article 7\(3\) EUTMR\)](#).

### 3 Decision

After the dialogue with the applicant has taken place, the Office will take a decision if it considers that the objection is well founded, despite the facts and arguments submitted by the applicant.

The decision will include the original objection, summarise the applicant's arguments, address the applicant's arguments and submissions, and give reasons and a detailed explanation as to why they are not convincing.

The objection can be waived in part if the Office considers that (i) **some** of the grounds have been overcome or (ii) **all** grounds have been overcome for some of the goods and services.

The decision will state that the application has been refused, either partly or in its entirety, indicating the goods and services rejected.

If a subsidiary claim of acquired distinctiveness through use has been made, the first decision will declare that the mark lacks inherent distinctiveness. The Office will only decide whether to refuse the application after it has examined the subsidiary claim and evidence of use.

The above, obviously, applies only to those cases where a claim under [Article 7\(3\) EUTMR](#) can be made. When an application is refused on the basis of a ground for refusal that cannot be overcome by means of [Article 7\(3\) EUTMR](#) (e.g. a refusal under [Article 7\(1\)\(e\)\(i\) to \(iii\) EUTMR](#)), a subsidiary claim of acquired distinctiveness will fail.

### 4 European criteria

[Article 7\(1\) EUTMR](#) is an EU provision and has to be interpreted on the basis of a common European standard. For example, it would be incorrect to apply different standards of distinctiveness based on the particularities of each EU Member State.

However, [Article 7\(2\) EUTMR](#) excludes an application from registration if a ground for refusal pertains only to part of the EU.

#### 4.1 Languages

##### 4.1.1 Glossary

The following expressions will be used in the Guidelines and should be understood according to the definitions provided below.

### **EU national languages**

EU national languages comprise two different groups.

1. **The Treaty languages**, also known as ‘**official EU languages**’, are those mentioned in [Regulation No 1](#)<sup>(10)</sup>. This states that the EU institutions have **24 official and working languages**: Bulgarian, Croatian, Czech, Danish, Dutch, English, Estonian, Finnish, French, German, Greek, Hungarian, Irish, Italian, Latvian, Lithuanian, Maltese, Polish, Portuguese, Romanian, Slovak, Slovenian, Spanish and Swedish.

English is an official EU language, despite the United Kingdom having left the EU. English is one of Ireland’s and Malta’s official languages and remains listed as such in

[Regulation No 1](#).

2. **Luxemburgish and Turkish**.

In addition to the Treaty languages, there are two other official languages at national level in the EU: **Luxemburgish** (in Luxembourg) and **Turkish** (in Cyprus).

### **EU regional languages**

An EU regional language is one that is not an EU national language but is traditionally used by people of a particular region in the EU. It may have constitutional recognition and be co-official in that area with the official language of the State (e.g. Basque, Catalan, Gallego or Valencian, which are co-official in their regions with Spanish). Other regional languages do not have that status, but are used by a relevant number of people in those regions (e.g. Alsatian, Breton, Neapolitan, Occitan and Sicilian).

For the purposes of these Guidelines, ‘EU regional languages’ also include dialects. A **dialect** is the form of a language that is spoken in one area of the EU with some grammar, words and/or pronunciation that may be different from other forms of the same language or a language that is spoken in a particular area, which can be a village, a city, a region, etc. For example, in 25/01/2018, [T-765/16](#), EL TOFIO El sabor de CANARIAS (fig.), EU:T:2018:31, the General Court dealt with the alleged descriptiveness of the word ‘tofió’, formerly used in a dialect spoken in Lanzarote and Fuerteventura (Canary Islands).

### **Non-EU languages**

This expression refers to languages that are neither EU national languages nor EU regional languages (e.g. Chinese, Hindi, Arabic or Russian).

#### 4.1.2 Relevant languages in AG examination

The Office can raise objections on the basis of **EU national languages** and also, **under specific circumstances**, on the basis of **a regional language or a non-EU**

---

<sup>10</sup> The Council of the European Union establishes the rules on the use of languages by the EU institutions, acting unanimously by means of regulations adopted in accordance with Article 342 of the Treaty on the Functioning of the European Union.

**language.** When the objection is based on a regional language or a non-EU language, the Office will explain in the objection letter why the language at issue is relevant.

The Office may become aware of the meaning of a word contained in a mark due either to the language check carried out during the examination proceedings or to evidence submitted in third-party observations.

#### 4.1.2.1 EU national languages

Regardless of the size or population of the respective country, the meaning of any word in any EU national language will be relevant for the absolute grounds examination.

In relation to official EU languages, see 03/07/2013, [T-236/12](#), Neo, EU:T:2013:343, § 57.

The General Court stated that since **Turkish** is an official language in Cyprus, it is understood and spoken by part of the population of Cyprus (13/06/2012, [T-534/10](#), Hellim, EU:T:2012:292, § 38). The same applies to **Luxembourgish** which has the status of an official language in Luxembourg.

#### 4.1.2.2 EU regional languages and non-EU languages

The examination of absolute grounds is not limited to EU national languages (13/12/2018, [T-830/16](#), PLOMBIR, EU:T:2018:941, § 53; 13/09/2012, [T-72/11](#), Espetec, EU:T:2012:424, § 35-36).

The existence of EU regional languages as well as the presence of minorities in the EU and in specific Member States speaking a non-EU language might, under the conditions mentioned below, justify the refusal of marks containing terms in languages other than EU national languages (e.g. Basque, Catalan, Chinese or Russian).

The Office will raise an objection only when there is convincing evidence that a given term has a meaning in an EU regional language or a non-EU language and is understood **by a non-negligible part of the relevant public in at least a part of the European Union** (06/10/2017, [T-878/16](#), KARELIA, EU:T:2017:702, § 27; 25/11/2015, [T-520/14](#), RACE GTP, EU:T:2015:884, § 29; 25/11/2015, [T-529/15](#), START UP INITIATIVE (fig.), EU:T:2016:747, § 55).

Words that are not commonly used (i.e. obsolete and extinct words or spoken only in remote parts of the country of origin of the language, very specific or highly technical terms) are unlikely to be understood by a non-negligible part of the relevant EU public and so will not be objected to. For example, the word 'tofió' is used in a dialect spoken on two of the Canary Islands. It refers to a type of bowl used in the past to collect goat milk. The General Court found that it had not been proved that the word 'tofió' had a clear meaning for a non-negligible part of the relevant public (25/01/2018, [T-765/16](#), EL TOFIO El sabor de CANARIAS (fig.), EU:T:2018:31, § 48).

In order to identify whether there is a **non-negligible** part of the relevant public who understands a term which is not in an EU national language, a case-by-case analysis of the factual situation must be made for that language. The analysis must evaluate the

number of people who speak the language within the EU and their geographical spread.

For example, the application for the word mark SHAKAHARI (EUTM No 17 680 521) was refused (before the UK left the EU) for, among other services, *restaurant services* in Class 43. ‘Shakahari’ is the transliteration of a term in Hindi meaning ‘vegetarian’. The relevant public included the UK Hindi-speaking population and the Indian and Nepali population in the EU, as well as consumers interested in Indian food or vegetarian food.

Regarding Russian, it is a well-known fact, confirmed by the General Court, that a significant proportion of Baltic States nationals know Russian or speak it as its mother tongue (19/07/2017, [T-432/16](#), медвѣдь (fig.), EU:T:2017:527; 13/12/2018, [T-830/16](#), PLOMBIR, EU:T:2018:941). Therefore, it is considered that Russian is understood by a non-negligible part of the relevant public in at least a part of the European Union.

**Table 1: Applications refused**

Sign	Reasoning	Case
Медведь	The sign consists of the Russian expression for the word ‘bear’. The mark was refused for, among other goods, <i>meat</i> in Class 29. The relevant public includes the Russian-speaking public in the EU, such as the inhabitants of the Baltic States, namely Estonia, Latvia and Lithuania.	19/07/2017, <a href="#">T-432/16</a> , медвѣдь (fig.), EU:T:2017:527 (EUTM <a href="#">14 397 921</a> )
	The sign consists of the Cyrillic verbal elements ‘Клубничное тоффи с соком’. These would be understood by the Russian-speaking population in the EU as ‘strawberry toffee, with juice’. The mark was refused for goods in Class 30, among others, <i>confectionery</i> . The features of the shape of the mark applied for, taken alone or combined with the verbal elements, were not considered to be distinctive.	EUTM 16 061 004

## 4.2 The baseline

The **baseline** is the ordinary understanding of the relevant public of the word in question. It can be corroborated by **dictionary entries**, examples of the use of the term in a descriptive manner found on internet **websites**, or it may clearly follow from the **ordinary understanding** of the term.

It is not necessary for the Office to prove that the word is the subject of a dictionary entry in order to refuse a sign. In particular, for composite terms, dictionaries do not mention all possible combinations. What matters is the ordinary and plain meaning. For example, terms used as specialised terminology to designate the respective relevant characteristics of the goods and services are considered descriptive. It is not necessary to demonstrate that the meaning of the term is immediately apparent to the relevant consumers of the goods and services. It suffices that the term is meant to be used, or could be understood by part of the relevant public, as a description either of the goods or services for which protection is sought or of a characteristic of the goods and services (17/09/2008, [T-226/07](#), Pranahaus, EU:T:2008:381, § 36; 18/11/2015, [T-558/14](#), TRILOBULAR, EU:T:2015:858, § 50).

An internet search is also a valid means of evidence of a meaning, in particular for new terms, technical jargon or slang words. However, the evidence should be carefully assessed to find out how the word is actually used, in particular in relation to descriptiveness. This is because often the difference between descriptive use and trade mark use on the internet is vague and the internet contains a vast amount of unstructured and unverified information or statements.

[Article 7\(1\) EUTMR](#) also applies to **transliterations** (transfers of a word from the alphabet of one language to another).

Transliterations into EU alphabets are treated in the same way, for the purpose of examining the absolute grounds for refusal, as words written in other EU original alphabets when the use of both characters is usual in a Member State. This would apply in relation to the three alphabets of the official EU languages – Latin, Cyrillic and Greek. It particularly applies to transliterations into Latin characters of Cyrillic (01/09/2017, [R 1177/2017-4](#), MALKA) and Greek (16/12/2010, [T-281/09](#), Chroma, EU:T:2010:537, § 34) because Bulgarians and Greeks are familiar with Latin characters.

Transliterations of words in non-EU alphabets into EU alphabets are treated in the same way, for the purpose of examining the absolute grounds for refusal, as words written in those non-EU languages when it can be established that a non-negligible part of the relevant public in at least a part of the European Union is accustomed to using both types of characters.



### 4.3 The relevant part of the EU

Where the objection is not based on the meaning of a word, the ground for refusal will normally pertain to the European Union as a whole. However, the relevant public's perception of the sign, the practice in trade, or the use of the goods and services claimed may be different in some parts of the European Union.

The Office's objections for signs containing verbal elements will always identify the language in which the sign is meaningful. Where the objection is based on the meaning of a word, the ground for refusal generally applies to part of the EU only ([Article 7\(2\) EUTMR](#)). The relevant part of the EU will depend on the language, terms used and goods and services.

The part of the EU affected by the objection is relevant in relation to the possibility for the applicant to file evidence to support its claim for acquired distinctiveness through use under [Article 7\(3\) EUTMR](#) (see the Guidelines, [Part B, Examination, Section 4, Absolute grounds for refusal, Chapter 14, Acquired distinctiveness through use \(Article 7\(3\) EUTMR\), paragraph 6](#) and in particular [6.2 Language area](#) on page 698).

The explicit mention of a territory or of an EU national language in the refusal will also affect the applicant's right to request the conversion of the EUTM application into one or more national application(s). The conversion is precluded (i) if a Member State is expressly indicated in the Office decision, **for that Member State** ([Article 140\(3\) EUTMR](#) in combination with [Article 139\(2\)\(b\) EUTMR](#)), (ii) if the language of a Member State is mentioned, for **all the Member States in which that language is one of the official languages** ([Article 140\(4\) EUTMR](#)). (see the Guidelines, [Part E, Register operations, Section 2, Conversion, Chapter 4, Grounds precluding conversion, paragraph 4.2](#)).

The Office is not obliged to indicate the relevant part of the territory in its refusal (confirmed by the General Court, (07/07/2021, [T-464/20](#), YOUR DAILY PROTEIN (fig.), EU:T:2021:421, § 60-62 and 09/03/2022, [T-204/21](#), Rugged, EU:T:2022:116)). However, when the territory is specifically relevant for the objection (e.g. for non-EU national languages or when the specific situation in a Member State is the basis of an objection under public policy and morality), its specific indication will be included in the decision.

#### 4.3.1 Relevant territory and objections based on EU national languages

The ground for refusal will apply, at least, in all the Member States where the language giving rise to the objection is official. Some languages are official in more than one Member State (see the Guidelines, [Part B, Examination, Section 4, Absolute grounds for refusal, Chapter 14, Acquired distinctiveness through use \(Article 7\(3\) EUMR\), paragraph 6.2](#)).

Under certain circumstances, the ground for refusal can also apply in a Member State where the language is not an official language.

The understanding of languages is not strictly limited by geographical borders. It may well be that, **for historical, cultural or cross-border market reasons**, certain (usually elementary) vocabulary of a given language may spread and be widely understood by the general public in other Member States, particularly those with contiguous land borders (e.g. ‘bon appétit’, ‘ciao’, ‘siesta’, ‘fiesta’, ‘merci’, ‘voilà’).

Some EU national languages are widely studied and spoken by the public not only in the Member State where it is official (e.g. English). Therefore, the following principles apply.

- Very basic English terms can be understood in the whole of the EU. Some examples of such terms are:
  - ‘forever’ and numbers below 10 (16/01/2014, [T-528/11](#), Forever, EU:T:2014:10, § 68);
  - ‘baby’ (05/07/2012, [T-466/09](#), Mc.Baby, EU:T:2012:346);
  - primary colours (27/06/2013, [T-367/12](#), MOL Blue Card, EU:T:2013:336; 28/09/2011, [T-356/10](#), Victory Red, EU:T:2011:543);
  - ‘champion’ (01/06/2016, [T-34/15](#), CHEMPIOIL / CHAMPION et al., EU:T:2016:330).
- English is widely understood in some Member States and therefore in those territories (such as, in particular, **Denmark, Finland, the Netherlands and Sweden**) the public’s understanding of English expressions is broader than basic terms (20/01/2021, [T-253/20](#), It’s like milk but made for humans, EU:T:2021:21, § 35).
- Specific knowledge of English can be acknowledged for certain professionals. The Court has ruled that the professional public is in a position to understand certain English terms that may form part of their professional vocabulary (29/03/2012, [T-242/11](#), 3D eXam, EU:T:2012:179, § 26). In addition:
  - English is very often used in **commercial communications** (09/03/2022, [T-204/21](#), Rugged, EU:T:2022:116, § 56).
  - The use of English is common in the **financial, electronics and telecommunications sectors** (26/09/2012, [T-301/09](#), Citigate, EU:T:2012:473, § 41).
  - English terms in the **medical** field are also likely to be understood because of the international influence in the sector (29/03/2012, [T-242/11](#), 3D eXam, EU:T:2012:179, § 26). For example, the EU professional public in the medical sector (patient safety field) has a specific practical interest in goods with characteristics of solidity, robustness or durability and may therefore understand the meaning of ‘rugged’ as ‘strong and designed to last a long time, even if treated roughly’ (09/03/2022, [T-204/21](#), Rugged, EU:T:2022:116, § 56-58).

#### 4.3.2 Relevant territory and objections based on EU regional languages and non-EU languages

Where the objection concerns EU regional languages that have constitutional recognition and/or are co-official, in a particular area, with the national official language

of the State, it will apply always, by default, at least to the Member State where this language is recognised/official.

For EU regional languages that do not have an official status in the particular State concerned and for non-EU languages, the objection will clearly state which language is concerned and will identify (at least) part of the relevant territory.

As regards Russian, the General Court has confirmed that the relevant consumers are, at least, the inhabitants of the Baltic States (Estonia, Latvia and Lithuania) (19/07/2017, [T-432/16](#), медвѣдь (fig.), EU:T:2017:527; 13/12/2018, [T-830/16](#), PLOMBIR, EU:T:2018:941).

## 5 Scope of Objections to the Goods and Services

Almost all absolute grounds for refusal, and in particular the most frequent ones of lack of distinctiveness, descriptiveness, genericness and deceptiveness, have to be assessed with respect to the goods and/or services for which protection is sought.

If an objection is raised, the Office must state specifically which ground (or grounds) for refusal apply to the mark in question, for each of the goods or services for which protection is sought.

In principle, an examination of the absolute grounds for refusal must be carried out in relation to each of the goods and services for which protection is sought, and it is necessary to state reasons in respect of each of those goods or services. However, the competent authority may use only general reasoning for all of the goods and services concerned where the same ground of refusal is given for a category or group of goods or services (18/03/2010, [C-282/09 P](#), P@yweb card / Payweb card, EU:C:2010:153, § 37 and § 38).

Therefore, for the same ground for refusal it is sufficient to provide general reasoning for one or more **homogenous categories** of goods and/or services, that is, groups of goods and/or services that have the same sufficiently direct and specific link to the sign. Criteria to establish this link can be, in particular, their characteristics, their essential qualities and their intended purposes (18/03/2010, [C-282/09 P](#), P@yweb card / Payweb card, EU:C:2010:153, § 46). The link must be specific and cannot be too general or abstract (18/03/2016, [T-501/13](#), WINNETOU, EU:T:2016:166, § 70-72).

For the analysis of the homogeneous nature of the relevant goods and/or services, the specificity of the mark applied for and its perception by the relevant public should be taken into account (03/12/2019, [T-658/18](#), DEVICE OF A CHECKERED GINGHAM PATTERN (fig.), EU:T:2019:830, § 62). Therefore, goods and/or services might form a homogeneous group for one sign (which describes a common characteristic) while those same goods and/or services might not form such a group in relation to another sign.

The placement of the goods and services in one or more groups or categories must be carried out in particular **on the basis of the characteristics that are common to them and that are relevant for the analysis of whether or not a specific absolute**

**ground for refusal may apply to the sign applied for in respect of those goods and services.** Therefore, the assessment must be carried out *in concreto* for the examination of each application and, as the case may be, for each of the different absolute grounds for refusal that may apply (25/01/2017, [C-437/15 P](#), *deluxe* (fig.), EU:C:2017:41, § 33).

Factors for homogenous groups can be, for example:

- that the goods are composed of the same ingredients or material (same fragrance in 12/12/2019, [T-747/18](#), SHAPE OF A FLOWER (3D), EU:T:2019:849; 11/04/2019, [T-223/17](#), same area of paints, coatings, adaptable materials in ADAPTA POWDER COATINGS (fig.), EU:T:2019:245);
- that the goods or services have the same intended purpose (to give an alarm signal in 19/12/2019, [T-270/19](#), ring (fig.), EU:T:2019:871; used in recycling and waste handling in 04/07/2019, [R 1441/2018-5](#), Ecotec; related to cleaning, freshening and washing in 13/08/2019, [R 881/2019-5](#), Botanical origin).

However, the mere fact that the relevant goods and services may be within the same class of the Nice Agreement is not sufficient in itself for a finding of homogeneity (17/10/2013, [C-597/12 P](#), *Zebexir*, EU:C:2013:672, § 40). The fictitious sign ‘Gourmet Dinner’, for example, could be considered laudatory and lacking distinctiveness for a variety of goods in Class 30, like pastries, cakes and ice creams, reasoning that all these goods are suitable to be served at a high-class dinner event, while this reasoning would not apply to chewing gum in the same class.

Overall, despite having differences, the goods and services could have a common characteristic relevant to the analysis that the Office has to carry out, that could justify their placement within a single homogenous group and the use by the Office of general reasoning in relation to them (22/03/2018, [T-235/17](#), *MOBILE LIVING MADE EASY*, EU:T:2018:162, § 31 and the case-law cited therein).

While forming homogeneous groups of goods and/or services allows a general, relatively short and concise reasoning, it is still necessary to give a clear picture of the nature of the goods and/or services in the decision.

As regards descriptiveness, an objection will apply not only to those goods and/or services for which the term(s) making up the trade mark applied for is/are directly descriptive, but also to the **broad category** that (at least potentially) contains an identifiable subcategory or specific goods/services for which the mark applied for is directly descriptive. In the absence of a suitable restriction by the applicant, the descriptiveness objection necessarily affects the broad category. For example, ‘EUROHEALTH’ is to be refused for ‘insurance’ as a whole and not only for ‘health insurance’ (07/06/2001, [T-359/99](#), *EuroHealth*, EU:T:2001:151, § 33).

An objection also applies to those goods and/or services that **are directly linked** to those for which the descriptive meaning pertains. Furthermore, if the descriptive meaning applies to an activity involving the use of several goods and/or services mentioned separately in the specification, then the objection applies to all of them (20/03/2002, [T-355/00](#), *Tele Aid*, EU:T:2002:79, § 38-39 (relating to a number of goods

and services offered in conjunction with, or applied to, remote assistance to car drivers)).

Some goods and services are what can be referred to as **auxiliary goods and/or services** in the sense that they are meant to be used with, or support the use of, the main goods or services. Typically, this covers paper and instruction manuals for the goods to which they belong or which are packed with them. These auxiliary goods and/or services are by definition intended to be used and sold together with the main product (e.g. vehicles and instruction manuals). It follows that if the sign is found to be descriptive of the main goods, logically it is also descriptive of the auxiliary goods, which are so closely related.

A different situation is that of broad categories of goods or stand-alone services that can support or be used by any other business as well, such as computer systems, advertising, transport and training. These services are defined as offering/rendering the services to third parties and therefore cannot be considered auxiliary services with reference to the goods and/or services. Advertising, for example (as well as the other previously mentioned services), is considered to be a fully-fledged service provided to third parties, and not just an ancillary vehicle to promote 'main' products.

Further examples:

<b>Sign</b>	<b>Case No</b>
BigXtra	11/12/2014, <a href="#">C-253/14 P</a> , BigXtra, EU:C:2014:2445
The Court confirmed the refusal for goods and services in Classes 16, 35, and 41 to 43 by means of general reasoning because of a sufficiently concrete and direct link for all these goods and services. For all of them, 'BigXtra' will be perceived as indicating price reductions or other advantages (para. 48).	
<b>Sign</b>	<b>Case No</b>
PIONEERING FOR YOU	12/12/2014, <a href="#">T-601/13</a> , Pioneering for You, EU:T:2014:1067
The General Court allowed general reasoning for goods and services in Classes 7, 9, 11, 37 and 42 because the promotional meaning of the sign applied for would be perceived identically for each of them (paras 36-37).	
<b>Sign</b>	<b>Case No</b>
Deluxe	<a href="#">C-437/15</a> EU:C:2017:380

Goods and services in Classes 9, 35, 37, 39 to 42 and 45 were considered to form a homogenous category, namely that all the goods, without exception, can be presented as being of superior quality, and all the services, without exception, can be presented as providing superior quality. However, objectively all these goods and services are of rather different nature (para. 35).

Sign	Case No
START UP initiative (fig.)	15/12/2016, <a href="#">T-529/15</a> , START UP INITIATIVE (fig.), EU:T:2016:747

The GC stated in relation to various business services in Classes 35, 36, 41 and 42: ‘Moreover, it should be noted that start-ups are likely to be found in a great many fields and, therefore, to need a wide range of services. This leads to the conclusion that the reasoning may be identical for different services which may be of interest to those start-ups and which may correspond to activities provided to them or by them, regardless of the fact that those services may not necessarily be homogenous. In those circumstances it was not necessary to repeat the same reasoning for each service or each category of services’.

## 6 Timing of Objections

Objections should be raised **as early as possible**. In the majority of cases, the Office raises its objection *ex officio* before the publication of the EUTM application.

The Office can reopen the examination of absolute grounds on its **own initiative at** any time before registration ([Article 45\(3\) EUTMR](#)), and in particular, upon receiving observations from **third parties** relating to the existence of an absolute ground for refusal or following an interim decision from the **Boards of Appeal** proposing to re-examine the contested EUTM application on absolute grounds.

Observations from third parties must be submitted before the end of the opposition period or before the final decision on an opposition is taken when an opposition has been filed ([Article 45\(2\) EUTMR](#)). The Office can then decide to reopen the examination procedure as a result of these observations. See [the Guidelines, Part B, Examination, Section 1, Proceedings, paragraph 3.1](#).

In the case of **international registrations** designating the EU, the Office can raise an objection as long as the opposition period (one month after republication) has not started ([Article 193\(7\) EUTMR](#)) and any interim status declaration previously sent would be revoked.

## 7 Disclaimers

Pursuant to [Regulation No 2015/2424](#) amending [Regulation No 207/2009](#) on the Community trade mark, it is no longer possible to file a disclaimer to indicate that protection is not requested for a specific element of a mark.

The Office will assess disclaimers filed **before** the date of entry into force of the abovementioned regulation (23/03/2016) according to the former practice applicable.

- As a general rule, a disclaimer will not help to overcome an absolute grounds objection.
- If the applicant's disclaimer does not overcome the ground for refusing registration, the application must be refused to the extent that is required.
- Where the applicant has made a disclaimer of a non-distinctive element in its application, the disclaimer will stay even if the Office does not consider it necessary.

***GUIDELINES FOR EXAMINATION OF  
EUROPEAN UNION TRADE MARKS***

***EUROPEAN UNION  
INTELLECTUAL PROPERTY OFFICE  
(EUIPO)***

***Part B***

***Examination***

***Section 4***

***Absolute grounds for refusal***

***Chapter 2***

***EUTM definition (Article 7(1)(a) EUTMR)***



## Table of Contents

<b>1 General Remarks.....</b>	<b>363</b>
1.1 Signs.....	363
1.2 Distinguishing character.....	364
1.3 Representation on the Register.....	364
<b>2 ‘Non-traditional’ Trade Marks and Article 7(1)(a) EUTMR.....</b>	<b>365</b>
2.1 Shape marks.....	366
2.2 Position marks.....	366
2.3 Pattern marks.....	366
2.4 Colour marks.....	367
2.5 Sound marks.....	369
2.6 Motion marks.....	371
2.7 Multimedia marks.....	375
2.8 Hologram marks.....	375
2.9 Other marks.....	375
2.9.1 Layout of a retail store.....	375
2.9.2 Smell/olfactory marks.....	376
2.9.3 Taste marks.....	377
2.9.4 Tactile marks.....	377
<b>3 Relationship with Other EUTMR Provisions.....</b>	<b>378</b>

## 1 General Remarks

[Article 7\(1\)\(a\) EUTMR](#) reflects the Office's obligation to refuse signs that do not conform to the requirements of [Article 4 EUTMR](#).

As from 01/10/2017, according to [Article 4 EUTMR](#), a European Union trade mark may consist of any **signs**, in particular words, including personal names, or designs, letters, numerals, colours, the shape of goods or of the packaging of goods, or sounds, provided that such signs are capable of **distinguishing** the goods or services of one undertaking from those of other undertakings and being **represented on the Register** of European Union trade marks (the Register) in a manner that enables the competent authorities and the public to determine the clear and precise subject matter of the protection afforded to its proprietor.

According to [Article 39\(2\)\(a\) EUTMR](#), 'Title II [application procedure] shall not apply to applications for an EU trade mark entered before 01/10/2017, as well as to international registrations for which the designation of the Union was made before that date'.

To be capable of constituting a trade mark for the purposes of [Article 4 EUTMR](#), the subject matter of an application must satisfy three conditions:

1. it must be a sign;
2. it must be capable of distinguishing the goods or services of one undertaking from those of others;
3. it must be capable of being represented on the Register in a way that allows the competent authorities and the public to determine the clear and precise subject matter of protection.

### 1.1 Signs

[Article 4 EUTMR](#) and [Article 3\(3\) EUTMR](#), read in conjunction, draw up a non-exhaustive list of signs that may constitute an EUTM: word marks, figurative marks, shape marks, position marks, pattern marks, single colour and combination of colour marks, sound marks, motion marks, multimedia marks, and hologram marks.

Where the mark does not fall within the definition of any of the specific types of marks listed in [Article 3\(3\) EUTMR](#), it can qualify as an 'other' mark provided for by [Article 3\(4\) EUTMR](#), provided it complies with the representation requirements set out in [Article \(3\)1 EUTMR](#).

Within this context, abstract concepts and ideas or general characteristics of goods are not specific enough to qualify as a sign, as they could apply to a variety of different manifestations (21/04/2010, [T-7/09](#), Spannfutter, EU:T:2010:153, § 25). For this reason, the Court rejected, for example, an application for a 'transparent collecting bin forming part of the external surface of a vacuum cleaner', as the subject matter was not a particular type of bin, but rather, in a general and abstract manner, all conceivable

shapes of a transparent bin with a multitude of different appearances (25/01/2007, [C-321/03](#), Transparent bin, EU:C:2007:51, § 35, 37).

## 1.2 Distinguishing character

[Article 4\(a\) EUTMR](#) refers to the capacity of a sign to distinguish the goods of one undertaking from those of another. Unlike [Article 7\(1\)\(b\) EUTMR](#), which concerns the distinctive character of a trade mark with regard to specific goods or services, [Article 4 EUTMR](#) is merely concerned with the abstract ability of a sign to serve as a badge of origin, regardless of the goods or services.

Only in very exceptional circumstances is it conceivable that a sign could not possess even the abstract capacity to distinguish the goods or services of one undertaking from those of another. An example for the lack of abstract capacity in the context of any goods or services could be the word 'Trademark'.

## 1.3 Representation on the Register

According to [Article 4\(b\) EUTMR](#), the sign applied for needs to be capable of being represented on the Register, in a manner that enables the competent authorities and the public to determine the clear and precise subject matter of the protection afforded to its proprietor.

Regarding the representation of the sign, [Article 3\(3\) EUTMR](#) lays down a non-exhaustive list of trade marks together with their definition and representation requirements. [Article 3\(4\) EUTMR](#) deals with 'other' types of marks. For more information in this regard, see the Guidelines, [Part B, Examination, Section 2, Formalities](#).

[Article 3\(1\) EUTMR](#) states that the trade mark can be represented in any appropriate form using generally available technology, as long as it can be reproduced on the Register in a clear, precise, self-contained, easily accessible, intelligible, durable and objective manner so as to enable the competent authorities and the public to determine with clarity and precision the subject-matter of the protection afforded to its proprietor.

The criteria listed by the EUTMR are identical to those established in the Sieckmann case (12/12/2002, [C-273/00](#), Sieckmann, EU:C:2002:748) with respect to the requirement for a clear and precise acceptable 'graphical' representation under the previous wording of the EUTMR.

[Article 3\(9\) EUTMR](#) clarifies that the filing of a sample or a specimen does not constitute a proper representation of a trade mark. The reason is that these cannot be clearly and precisely represented and are not generally available for inspection on the Register by means of commonly available technology. For example, a sample of a scent would not be a durable and stable representation of a trade mark, thereby not complying with the clarity and precision requirements.

[Article 3\(2\) EUTMIR](#) makes clear that the subject matter of the registration is defined by the **representation of the mark**. In the limited number of cases where the representation is accompanied by a description (see below), the description must accord with the representation and must not extend its scope.

Whenever the representation of the sign does not enable the competent authorities (namely trade mark offices and courts) and competitors to determine the clear and precise subject matter of the protection afforded to its proprietor, the mark has to be refused for not complying with [Article 7\(1\)\(a\) EUTMR](#). This is an objective assessment to be carried out by applying the criteria listed in [Article 3\(1\) EUTMIR](#), for which no particular consumer segment has to be taken into account.

Where the applicant has duly complied with the formalities requirements (see the Guidelines, [Part B, Examination, Section 2, Formalities, paragraph 9](#)) — that is, the filing of a representation of the sign in accordance with the corresponding requirements of [Article 3\(1\) and \(3\) EUTMIR](#) and correct indication of the type of mark — the representation of the sign on the Register should enable the competent authorities and the public to determine the clear and precise subject matter of protection of the mark.

Nevertheless, issues in this respect are more likely to arise pursuant to [Article 31\(1\)\(d\) EUTMR](#) where the mark applied for does not qualify as one of the types of marks listed in [Article 3\(3\) EUTMIR](#) but as an ‘other’ type of mark ([Article 3\(4\) EUTMIR](#)), for which there are no specific explicit rules on representation other than that of complying with the standards set out in [Article 3\(1\) EUTMIR](#).

## 2 ‘Non-traditional’ Trade Marks and Article 7(1)(a) EUTMR

Assessing whether the representation of the sign enables the competent authorities and the public to determine the clear and precise subject matter of protection of the mark seems rather straightforward for traditional types of marks (word and figurative marks). To the extent that these marks have passed the Office’s formalities examination, they can, in general, be assessed directly under the other grounds of [Article 7 EUTMR](#) as there should not be any issues under [Article 7\(1\)\(a\) EUTMR](#).

A closer examination of the requirements under [Article 7\(1\)\(a\)](#) and [Article 4 EUTMR](#) might, however, be needed in the case of less ‘traditional’ signs.

Although **graphical** representation as a general requirement has been abolished, the existing case-law dealing with the graphical representation of signs is still relevant in some cases for understanding the requirement that signs have to be capable of being adequately represented on the Register.

## 2.1 Shape marks

According to [Article 3\(3\)\(c\) EUTMIR](#), a shape mark is a trade mark consisting of, or extending to, a three-dimensional shape, including containers, packaging, the product itself or its appearance.

The term ‘extending to’ means that these marks cover not only the shapes per se, but also shapes that contain word or figurative elements, labels, etc.

The representation of shape marks requires one of the following to be submitted:

- a graphic reproduction of the shape, including computer-generated imaging;
- a photographic reproduction.

The graphic or photographic reproduction may contain different views. Where the representation is not provided electronically, it may contain up to six different views.

## 2.2 Position marks

According to [Article 3\(3\)\(d\) EUTMIR](#), a position mark is a trade mark consisting of the specific way in which the mark is placed on or affixed to the goods.

The abovementioned article stipulates the following mandatory and optional representation requirements for position marks.

An appropriate identification of the **position** of the mark and its size or proportion **with respect** to the relevant goods (mandatory).

A visual disclaimer of those elements that are not intended to form part of the subject-matter of the registration (mandatory). The EUTMIR gives preference to broken or dotted lines.

A description explaining how the sign is affixed to the goods (optional). The representation should by itself clearly define the position of the mark as well as its size or proportion with respect to the goods. Therefore, according to [Article 3\(2\) EUTMIR](#), the description may only serve explanatory purposes; it cannot serve to substitute visual disclaimers.

An objection under [Article 7\(1\)\(a\) EUTMR](#) may be raised for those goods on which the positioning of the mark is unclear. For example, if a position mark is applied for in respect of *clothing, footwear and headgear*, but the representation identifies the position of the mark on *footwear* only, an objection should be raised for *clothing* and *headgear*.

## 2.3 Pattern marks

[Article 3\(3\)\(e\) EUTMIR](#) defines pattern marks as those trade marks consisting exclusively of a set of elements that are repeated regularly.

The article requires that pattern marks ‘be represented by submitting a reproduction showing the pattern of repetition.’ Descriptions detailing how its elements are repeated in a regular pattern are allowed for this type of mark. For other cases where the EUTMIR allows for the possibility of adding descriptions, the description must accord with the representation and must not extend its scope.

## 2.4 Colour marks

According to [Article 3\(3\)\(f\) EUTMIR](#), colour marks are either single colour marks without contours or a combination of colours without contours.

1. Trade marks consisting exclusively of a single colour (without contours) require:
  - a reproduction of the colour (mandatory);
  - a reference to a generally recognised colour code (mandatory).
2. Trade marks consisting exclusively of a combination of colours (without contours) require:
  - a reproduction of the colour combination that shows the systematic arrangement of the colour combination in a uniform and predetermined manner (mandatory);
  - a reference to a generally recognised colour code (mandatory);
  - a description detailing the systematic arrangement of the colours (optional).

For colour combinations, the EUTMIR has applied the case-law according to which the representation ‘must be systematically arranged by associating the colours concerned in a predetermined and uniform way’, as the Court of Justice stated that the mere juxtaposition of two or more colours, without shape or contours, or a reference to two or more colours ‘in every conceivable form’, did not meet the requisite standards of precision and uniformity (24/06/2004, [C-49/02](#), Blau/Gelb, EU:C:2004:384, § 33-34);

If a combination of colours without contours is not systematically arranged in a uniform and predetermined manner, too many different variations would be possible and this would not allow the competent authorities and economic operators to know the precise scope of the registrations.

As the trade mark’s subject matter of protection is exclusively determined by the representation itself, any voluntary description detailing the systematic arrangement must accord with the representation (i.e. it cannot be inconsistent with the image shown) and must not extend beyond its subject matter (Article 3(2) EUTMIR). In addition, a lack of accord between the representation and the description leads to a lack of clarity and precision of the mark (Article 3(2) EUTMIR).

Example of signs that are **acceptable** (with or without a description):

Sign	Case No
	<p>EUTM 11 055 811</p> <p><u>Description:</u> The mark consists of five stripes of colour arranged horizontally and directly adjoining each other, their length being several times larger than their height. The colour distribution from the top to the bottom is: very light green, light green, medium green, dark green and very dark green. Proportion of the five colours: 20 % each.</p>

The sign can also indicate how the colours will be applied to the goods at issue where this is made by means of an iconic representation (as opposed to a naturalistic one), as shown in the following examples:

Sign	Case No
 <p><u>Colour indication:</u> RAL 9018; NCS S 5040G50Y + RAL 9018 1 : 4; NCS S 5040G50Y + RAL 9018 2 : 3; NCS S 5040G50Y + RAL 9018 3 : 2; NCS S 504050Y + RAL 9018 4 : 1: NCS S 5040G50Y.</p> <p><u>Description:</u> none</p> <p>Class 7 — <i>Wind energy converters, and parts therefor.</i></p>	<p>EUTM: 2 346 542</p> <p>03/05/2017, <a href="#">T-36/16</a>, BLENDED SHADE OF GREEN, EU:T:2017:295</p>
<p>[T]he contested mark was registered as a colour mark (§ 36).</p> <p>Consequently ... the upright trapezoidal shape is not part of the subject matter of the protection sought and that element does not set contours to the colours, but only serves to indicate how the colours will be applied on the goods at issue. The protection sought is thus for a specific combination of colours applied on the lower section of a shaft, irrespective of the shape of that shaft, which is not part of the subject matter of the protection sought. (§ 40)</p>	

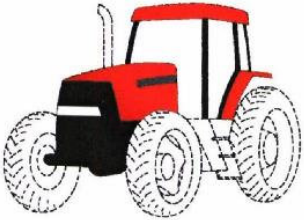
Sign	Case No
 <p><u>Colours indicated:</u> Red, black and grey</p> <p><u>Description:</u> The mark consists of the combination of the colours red, black and grey as applied to the exterior surfaces of a tractor, namely red as applied to the bonnet, roof and wheel arches, light and dark grey as applied to the bonnet in a horizontal stripe and black as applied to the front bonnet grill, chassis and vertical trim — as depicted in the illustrative representation attached to the application.</p>	<p>EUTM 9 045 907</p> <p>(This mark was applied for as ‘other’ under the previous regime, indicating that it was a position mark. The example is given here to show that it can also be filed as a colour mark (combination of colours), showing how the combination appears on the products.)</p>

## 2.5 Sound marks

[Article 3\(3\)\(g\) EUTMIR](#) defines sound marks as trade marks consisting exclusively of a sound or combination of sounds.

EUTM applications for sound marks can **only** be an audio file reproducing the sound **or** an accurate representation of the sound in musical notation (for technical information and further details on **valid means** of representation of sound marks, see the Guidelines, [Part B, Examination, Section 2, Formalities](#)).

Other means of representation, such as onomatopoeia, musical notes alone and sonograms will not be accepted as representations of sound marks for EUTM applications. In all cases, these representations would not sufficiently enable the competent authorities and the public to determine the clear and precise subject matter of protection.

- Description of a sound in words
 

A description such as certain notes of a piece of music, for example, ‘the first 9 bars of *Für Elise*’, or a description of the sound in words, for example, ‘the sound of a cockcrow’, is not sufficiently precise or clear and therefore does not make it possible to determine the scope of the protection sought (27/11/2003, [C-283/01](#), Musical notation, EU:C:2003:641, § 59).
- Onomatopoeia



There is a lack of consistency between the onomatopoeia itself, as pronounced, and the actual sound or noise, or the sequence of actual sounds or noises, that it purports to imitate phonetically (27/11/2003, [C-283/01](#), Musical notation, EU:C:2003:641, § 60).

- Musical notes alone

A sequence of musical notes alone, such as E, D#, E, D#, E, B, D, C, A, does not constitute a graphical representation. Such a description, which is neither clear, nor precise nor self-contained, does not make it possible, in particular, to determine the pitch and duration of the sounds forming the melody for which registration is sought and that constitute essential parameters for the purposes of knowing the melody and, accordingly, of defining the trade mark itself (27/11/2003, [C-283/01](#), Musical notation, EU:C:2003:641, § 61).

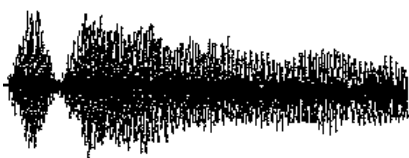
<b>Example of an unacceptable sound mark</b>	
<p>EUTM No 143 891</p> <p><a href="#">R 781/1999-4</a> (ROARING LION)</p> <p>The (alleged) sonogram was considered incomplete, as it did not contain a representation of scale of the time axis and the frequency axis (para. 28).</p>	

<b>Example of acceptable sound marks</b>	
<p>CP 11 <sup>(11)</sup></p> <p><a href="#">Invented word</a></p>	<p>Although the verbal element perceived in the sound has no meaning, the representation of the sound mark enables the competent authorities and the public to determine the clear and precise subject matter of protection.</p>
<p>CP 11</p> <p><a href="#">Street noises</a></p>	<p>The representation of the sound mark enables the competent authorities and the public to determine the clear and precise subject matter of protection, despite perceiving many different sounds together in the file.</p>

<sup>11</sup> In the framework of the European Union Intellectual Property Network, the trade mark offices of the European Union have agreed on a Common Communication on New Types of Marks: Examination of Formal Requirements and Grounds for Refusal (referred to as Common Practice 11, or [CP11](#)). They agreed on examples of representations of sound marks, motion marks and multimedia marks that can/cannot enable the competent authorities and the public to determine the clear and precise subject matter of protection.

## 2.6 Motion marks

[Article 3\(3\)\(h\) EUTMR](#) defines motion marks as ‘trade mark(s) consisting of, or extending to, a movement or a change in the position of the elements of the mark’.

The definition does not restrict motion marks to those depicting movement. A sign may also qualify as a motion mark if it is capable of showing a change in the position of the elements (for instance a sequence of stills). Motion marks do not include sound (see the definition of a multimedia mark below).

Pursuant to [Article 3\(3\)\(h\) EUTMR](#), motion marks must be represented by submitting one of the following:

- a video file showing the movement or change of position;
- a series of still sequential images showing the movement; the images may be numbered or accompanied by a description explaining the sequence.

A motion mark **may only be refused** registration under [Article 7\(1\)\(a\) EUTMR](#) when a reasonably observant person with normal levels of perception and intelligence would, upon consulting the EUTM register, not be able to understand precisely what the mark consists of, without expending a huge amount of intellectual energy and imagination (23/09/2010, [R 443/2010-2](#), RED LIQUID FLOWING IN SEQUENCE OF STILLS (MOVEMENT MARK), § 20).

Examples of **acceptable** representations **for motion marks**.



Sign	Case No
------	---------

<div style="text-align: center;">  </div> <p><u>Description:</u> this is a motion mark in colour. The nature of the motion is that of a trailing ribbon with a liquid-like appearance (ribbon). The ribbon flows around and ultimately into a spherical shape (sphere). The motion takes approximately 6 seconds. The stills in the sequence are spaced approximately 0.3 seconds apart and are evenly spaced from the beginning to the end of sequence. The first still is at top left. The last still (20th) is the middle one in the bottom row. The stills follow a progression from left to right within each row, before moving down to the next row. The precise sequence of the stills is as follows: in the 1st still, the ribbon enters the frame in the upper edge of the frame and flows down the right edge of the frame, before flowing upward in the 2nd to 6th stills. During that phase of motion (in the 4th still) the end of the ribbon is shown, producing the effect of a trailing ribbon. In the 6th to 17th stills, the ribbon flows counterclockwise around the frame. From the 9th still onwards, the sphere appears in the centre of the frame. The interior of the sphere is the same colour as the ribbon. The ribbon flows around the sphere. In the 14th still, the ribbon enters the sphere, as if being pulled inside. In the 15th to 17th stills, the ribbon disappears inside the sphere. In the 19th and 20th stills, the sphere moves toward the viewer, gaining in size and ending the motion.</p>	<p>EUTM No 8 581 977 RED LIQUID FLOWING IN SEQUENCE OF STILLS (MOVEMENT MARK) <a href="#">R 443/2010-2</a></p>
---	--

<b>Sign</b>	<b>EUTM No</b>
-------------	----------------

 <p><u>Description:</u> the mark is an animated sequence with two flared segments that join in the upper right portion of the mark. During the animation sequence, a geometric object moves upwards adjacent to the first segment and then downwards adjacent to the second segment, while individual chords within each segment turn from dark to light. The stippling in the mark is for shading only. The entire animated sequence lasts between 1 and 2 seconds.</p>	<p>EUTM No 5 338 629</p>
---	------------------------------

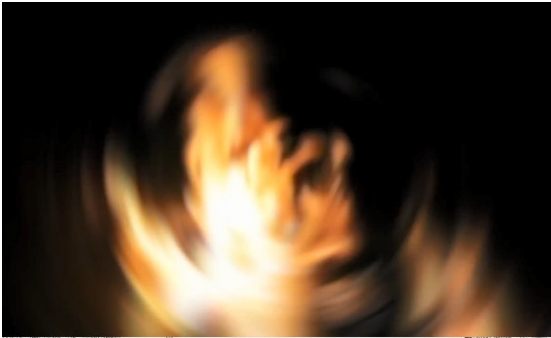
Examples of acceptable representations for motion marks from CP11 <sup>(12)</sup>.

 <p><a href="#">LINK</a></p>	<p>Despite consisting of a blurred image, the representation of this motion mark enables the competent authorities and the public to determine the clear and precise subject matter of protection.</p>
 <p><a href="#">LINK</a></p>	<p>Although the representation of this motion mark contains non-identifiable images, it enables the competent authorities and the public to determine the clear and precise subject matter of protection.</p>

Examples of **unacceptable** representations for motion marks.

<sup>12</sup> In the framework of the European Union Intellectual Property Network, the trade mark offices of the European Union have agreed on a Common Communication on New Types of Marks: Examination of Formal Requirements and Grounds for Refusal (referred to as Common Practice 11, or [CP11](#)). They agreed on examples of representations of sound marks, motion marks and multimedia marks that can/cannot enable the competent authorities and the public to determine the clear and precise subject matter of protection.

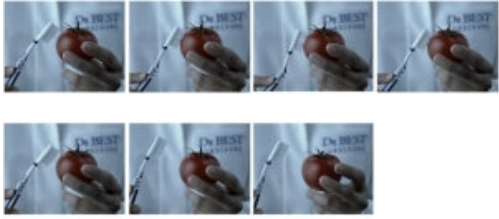
Sign	EUTM No
 <p data-bbox="226 533 1193 667"><u>Description:</u> The mark comprises a moving image consisting of a toothbrush moving towards a tomato, pressing onto the tomato without breaking the skin, and moving away from the tomato.</p>	<p data-bbox="1193 432 1361 499">EUTM No 9 742 974</p>
<p data-bbox="226 678 1361 745">The Office rejected the application as it was not possible to establish the precise movement from the description provided along with the representation.</p>	

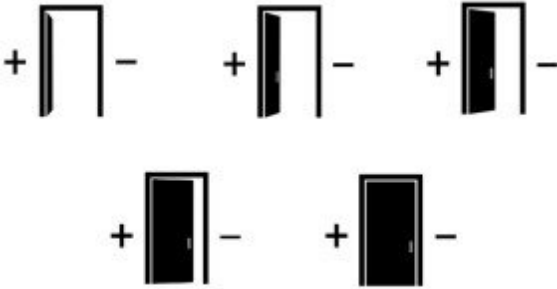
Sign	EUTM No
 <p data-bbox="226 1332 1193 1601"><u>Description:</u> the mark consists of an animated sequence on a plain background, namely a door that can be opened in the following three stages: open/mid-open/closed or closed/mid-open/open, using the symbols '+' and '-'. The length of the animation between the stages is half a second. The door and its frame are rectangular and are in the style of a basic geometric drawing with a small rectangular handle, opening onto a plain background. The symbols '+' and '-' are placed by each of the long edges of the frame.</p>	<p data-bbox="1193 1209 1361 1321">EUTM No 16 023 09 5</p>
<p data-bbox="226 1639 1361 1874">The Office rejected the application as it was not possible to establish the precise movement from the description provided along with the graphic representation. A sign that consists of the opening and closing of a door by pushing buttons on the left or right of the latter is subject to the consumer's personal interpretation. The sign therefore cannot fulfil the clarity and precision requirements under <a href="#">Article 4 EUTMR</a> because each consumer would interpret it in a different way and would be subjected to a different sequence of the movement mark.</p>	

## 2.7 Multimedia marks

According to [Article 3\(3\)\(i\) EUTMIR](#), a multimedia mark is a trade mark consisting of, or extending to, the combination of image and sound.

The article requires that multimedia marks ‘be represented by submitting an audiovisual file containing the combination of the image and the sound’.

Examples of acceptable representations for motion marks from [CP11](#) <sup>(13)</sup>:

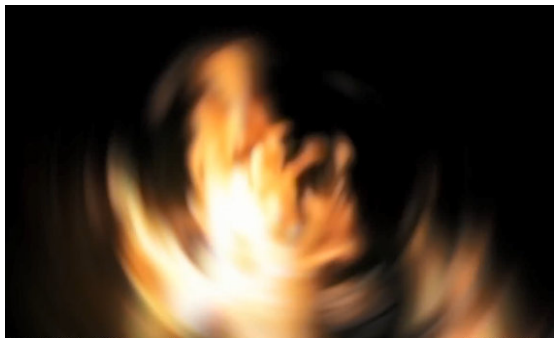
 <a href="#">LINK</a>	<p>Despite consisting of a blurred image and the fact that the verbal element perceived in the sound has no meaning, the representation of this multimedia mark enables the competent authorities and the public to determine the clear and precise subject matter of protection.</p>
---	---

## 2.8 Hologram marks

[Article 3\(3\)\(j\) EUTMIR](#) defines a hologram mark as a trade mark consisting of elements with holographic characteristics, and adds that it ‘shall be represented by submitting a video file or a graphic or photographic reproduction containing the views which are necessary to sufficiently identify the holographic effect in its entirety.’

## 2.9 Other marks

The following types of marks are not explicitly included in the non-exhaustive list of types of marks provided by [Article 3\(3\) EUTMIR](#). They fall under the category of the mark type ‘other’.

### 2.9.1 Layout of a retail store

In its judgment of 10/07/2014, [C-421/13](#), Apple Store, EU:C:2014:2070, § 19, the Court of Justice found that a representation that depicts the layout of a retail store may

<sup>13</sup> In the framework of the European Union Intellectual Property Network, the trade mark offices of the European Union have agreed on a Common Communication on New Types of Marks: Examination of Formal Requirements and Grounds for Refusal (referred to as Common Practice 11, or [CP11](#)). They agreed on examples of representations of sound marks, motion marks and multimedia marks that can/cannot enable the competent authorities and the public to determine the clear and precise subject matter of protection.

constitute a trade mark provided that it is capable of distinguishing the products or services of one undertaking from those of other undertakings. The layout was represented by means of a single design, combining lines, curves and shapes, without any indication of the size or proportions.

Sign	Case No
	10/07/2014, <a href="#">C-421/13</a> , Apple Store, EU:C:2014:2070

Following the abovementioned judgment, it cannot be excluded that the requirements for the representation of the layout of a retail store could be satisfied by a design alone, combining lines, curves and shapes, without any specific indication of the size or proportions in the description. The Court indicated that in such a case, the trade mark could be registered, provided that the sign is capable of distinguishing the services of the applicant for registration from those of other undertakings and if no other grounds for refusal apply.

As a representation that depicts the layout of a retail store is not strictly covered by any of the types of marks listed in [Article 3\(3\) EUTMIR](#), the representation must comply with the standards set out in [Article 3\(1\) EUTMIR](#) and may be accompanied by a description clearly specifying the subject matter for which protection is sought.

## 2.9.2 Smell/olfactory marks

It is currently not possible to represent smells in compliance with [Article 4 EUTMR](#), as the subject matter of protection cannot be determined with clarity and precision **with generally available technology**.

[Article 3\(9\) EUTMIR](#) specifically excludes the filing of samples.

The following are examples of non-satisfactory means of representation of a smell.

- *Chemical formula*  
Only specialists in chemistry would recognise the odour in question from such a formula.
- *Representation and description in words*  
The representation requirements are not satisfied by:
  - a graphic representation of the smell;
  - a description of the smell in words;
  - a combination of both (graphic representation and description in words).

Sign	Case No
 Mark description: Smell of ripe strawberries	EUTM No 1 122 118
<p><b>27/10/2005, <a href="#">T-305/04</a>, Odeur de fraise mûre, EU:T:2005:380, § 34</b></p> <p>The Court considered that the smell of strawberries varies from one variety to another and the description ‘smell of ripe strawberries’ can refer to several varieties and therefore to several distinct smells. The description was found neither unequivocal nor precise and did not eliminate all elements of subjectivity in the process of identifying and perceiving the sign claimed.</p>	

In its judgment of 12/12/2002, [C-273/00](#), Sieckmann, EU:C:2002:748, § 69-73, the Court dismissed the possibility of representing an olfactory mark by a chemical formula, by a description in writing, by the deposit of an odour sample or by a combination of those elements.

There is no generally accepted international classification of smells that would make it possible — as with international colour codes or musical notation — to identify an olfactory sign objectively and precisely by attributing a name or precise code specific to each smell (27/10/2005, [T-305/04](#), Odeur de fraise mûre, EU:T:2005:380, § 34).

### 2.9.3 Taste marks

It is currently not possible to represent a taste in compliance with [Article 4 EUTMR](#) as [Article 3\(9\) EUTMIR](#) specifically excludes the filing of samples and the subject matter of protection cannot be determined with clarity and precision **with generally available technology**.

The arguments mentioned above under [paragraph 2.9.2](#) similarly apply to taste marks (04/08/2003, [R 120/2001-2](#), THE TASTE OF ARTIFICIAL STRAWBERRY FLAVOUR (GUSTATORY MARK)).

### 2.9.4 Tactile marks

It is currently not possible to represent the tactile effect of a certain material or texture in compliance with [Article 4 EUTMR](#) as [Article 3\(9\) EUTMIR](#) specifically excludes the filing of samples and the subject matter of protection cannot be determined with clarity and precision with generally available technology.

The arguments mentioned above under [paragraph 2.9.2](#) similarly apply to tactile marks (27/05/2015, [R 2588/2014-2](#), EMBOSSED PATTERN ON A SMOOTH BOTTLE SURFACE (TACTILE MARK)).



### 3 Relationship with Other EUTMR Provisions

[Article 7\(1\)\(a\) EUTMR](#) reflects the Office's obligation to refuse signs that do not conform to the requirements of [Article 4 EUTMR](#). If the sign does not meet these requirements and the representation is not clear and precise, the application will not be examined on the basis of the other absolute grounds for refusal.

According to [Article 7\(3\) EUTMR](#), the absolute grounds for refusal under [Article 7\(1\)\(a\) EUTMR](#) cannot be overcome through acquired distinctiveness in consequence of use of the mark.

***GUIDELINES FOR EXAMINATION OF  
EUROPEAN UNION TRADE MARKS***

***EUROPEAN UNION  
INTELLECTUAL PROPERTY OFFICE  
(EUIPO)***

***Part B***

***Examination***

***Section 4***

***Absolute grounds for refusal***

***Chapter 3***

***Non-distinctive trade marks (Article 7(1)(b)  
EUTMR)***

## Table of Contents

<b>1 General Remarks.....</b>	<b>381</b>
<b>2 Word Elements.....</b>	<b>381</b>
<b>3 Single Letters .....</b>	<b>383</b>
3.1 General considerations.....	383
3.2 Examples.....	384
<b>4 Slogans: Assessing Distinctive Character.....</b>	<b>385</b>
<b>5 Simple Figurative Elements.....</b>	<b>390</b>
<b>6 Commonplace Figurative Elements.....</b>	<b>396</b>
<b>7 Typographical Symbols.....</b>	<b>397</b>
<b>8 Pictograms.....</b>	<b>399</b>
<b>9 Common/Non-Distinctive Labels.....</b>	<b>405</b>
<b>10 Shape Marks.....</b>	<b>407</b>
10.1 Preliminary remarks.....	407
10.2 Shapes unrelated to the goods or services themselves.....	407
10.3 Shape of the goods themselves or shapes related to the goods or services; shape of the packaging or containers.....	408
10.3.1 Elements and factors affecting the distinctiveness of the sign as a whole when the shape is non-distinctive (CP9).....	410
10.3.2 Shape of the goods themselves or shapes related to the goods or services.....	431
10.3.3 Shape of the packaging or containers.....	436
<b>11 Position Marks.....</b>	<b>439</b>
<b>12 Pattern Marks.....</b>	<b>441</b>
<b>13 Colour Marks.....</b>	<b>447</b>
13.1 Single Colours.....	447
13.2 Colour combinations.....	450
<b>14 Sound Marks.....</b>	<b>452</b>
<b>15 Motion Marks.....</b>	<b>459</b>
<b>16 Multimedia Marks.....</b>	<b>461</b>
<b>17 Hologram Marks.....</b>	<b>463</b>

## 1 General Remarks

Distinctiveness of a trade mark within the meaning of [Article 7\(1\)\(b\) EUTMR](#) means that the sign serves to identify the goods and/or services for which registration is sought as originating from a particular undertaking, and thus to distinguish those goods and/or services from those of other undertakings (29/04/2004, [C-468/01 P](#) - [C-472/01 P](#), Tabs (3D), EU:C:2004:259, § 32; 21/10/2004, [C-64/02 P](#), Das Prinzip der Bequemlichkeit, EU:C:2004:645, § 42; 08/05/2008, [C-304/06 P](#), Eurohypo, EU:C:2008:261, § 66; 21/01/2010, [C-398/08 P](#), Vorsprung durch Technik, EU:C:2010:29, § 33). Such distinctiveness can be assessed only by reference first to the goods or services for which registration is sought and, second, to the relevant public's perception of that sign (12/07/2012, [C-311/11 P](#), Wir machen das Besondere einfach, EU:C:2012:460, § 24 and case-law cited therein).

A minimum degree of distinctiveness is sufficient to prevent the application of the absolute ground for refusal provided for in [Article 7\(1\)\(b\) EUTMR](#) (03/04/2019, [T-555/18](#), See More. Reach More. Treat More., EU:T:2019:13, § 19).

A word mark that is descriptive of characteristics of goods or services for the purposes of [Article 7\(1\)\(c\) EUTMR](#) is, on that account, necessarily devoid of any distinctive character with regard to the same goods or services for the purposes of [Article 7\(1\)\(b\) EUTMR](#) (12/06/2007, [T-190/05](#), Twist & Pour, EU:T:2007:171, § 39).

In a similar vein, even though a given term might not be clearly descriptive with regard to the goods and services concerned, as to the point that an objection under [Article 7\(1\)\(c\) EUTMR](#) would not apply, the term would still be objectionable under [Article 7\(1\)\(b\) EUTMR](#) on the ground that it will be perceived by the relevant public as only providing information on the nature of the goods and/or services concerned and not as indicating their origin. This was the case with the term 'medi', which was considered as merely providing information to the relevant public about the medical or therapeutic purpose of the goods or of their general reference to the medical field (12/07/2012, [T-470/09](#), Medi, EU:T:2012:369, § 22).

An objection under [Article 7\(1\)\(b\) EUTMR](#) will apply in those cases where the lexical structure employed, although not correct from a grammatical point of view, can be considered to be common in advertising language and in the commercial context at issue (25/04/2013, [T-145/12](#), Eco Pro, EU:T:2013:220, § 29-32).

## 2 Word Elements

Words are non-distinctive or cannot confer distinctiveness on a composite sign if they are so frequently used that they have lost any capacity to distinguish goods and services. The following terms, alone or in combination with other unregistrable elements, fall foul of this provision.

Terms merely denoting a particular **positive or appealing quality or function** of the goods and services may be refused if applied for alone and/or in combination with descriptive terms:

- **ECO** as denoting ‘ecological’ (24/04/2012, [T-328/11](#), EcoPerfect, EU:T:2012:197, § 25; 15/01/2013, [T-625/11](#), EcoDoor, EU:T:2013:14, § 21);
- **FLEX** and **FLEXI** as referring to ‘flexible’ (13/06/2014, [T-352/12](#), Flexi, EU:T:2014:519, § 20-21);
- **GREEN** as being ‘environmentally friendly’ (27/02/2015, [T-106/14](#), Greenworld, EU:T:2015:123, § 24);
- **MEDI** as referring to ‘medical’ (12/07/2012, [T-470/09](#), Medi, EU:T:2012:369);
- **MULTI** as referring to ‘much, many, more than one’ (17/11/2005, [R 904/2004-2](#), MULTI);
- **MINI** as denoting ‘very small’ or ‘tiny’ (17/12/1999, [R 62/1999-2](#), MINIRISC);
- **MEGA** as denoting ‘big’ (28/04/2015, [T-137/13](#), MEGARAIL, EU:T:2015:232, § 38);
- **Premium/PREMIUM** as referring to ‘best quality’ (22/05/2012, [T-60/11](#), Suisse Premium, EU:T:2012:252, § 46-49, 56, 58; 17/01/2013, [T-582/11](#) & [T-583/11](#), Premium XL / Premium L, EU:T:2013:24, § 26);
- **PRO** as an indication that the designated goods are intended for ‘professionals’ or are ‘supporting’ something (25/04/2013, [T-145/12](#), Eco Pro, EU:T:2013:220, § 29-32).
- **PLUS** as denoting ‘additional, extra, of superior quality, excellent of its kind’. (15/12/1999, [R 329/1999-1](#), PLATINUM PLUS);
- **SUPER** for highlighting the ‘positive qualities of the goods or services’ (judgments of 19/05/2010, [T-464/08](#), Superleggera, EU:T:2010:212, § 23-30; 20/11/2002, [T-79/01](#) & [T-86/01](#), Kit Pro / Kit Super Pro, EU:T:2002:279, § 26);
- **ULTRA** as denoting ‘extremely’ (09/12/2002, [R 333/2002-1](#), ULTRAFLEX);
- **UNIVERSAL** as referring to goods that are ‘fit for general or universal use’ (02/05/2012, [T-435/11](#), UniversalPHOLED, EU:T:2012:210, § 22, 28).

**Top level domain** endings, such as ‘.com’, only indicate the place where information can be found on the internet and thus cannot render a descriptive or otherwise objectionable mark registrable. Therefore, www.books.com is as objectionable for printed matter as the term ‘books’ alone. This was confirmed by the General Court in its judgment of 21/11/2012, [T-338/11](#), PHOTOS.COM, EU:T:2012:614, § 22, where it was stated that the element ‘.com’ is a technical and generic element, the use of which is required in the normal structure of the address of a commercial internet site. Furthermore, it may also indicate that the goods and services covered by the trade mark application can be obtained or viewed online, or are internet related. Accordingly, the element in question must also be considered to be devoid of distinctive character in respect of the goods or services concerned.

**Abbreviations** of the **legal form of a company** such as Ltd., GmbH, etc. cannot add to the distinctiveness of a sign.

Names of individual persons are distinctive, irrespective of the frequency of the name and even in the case of the most common surnames, such as Jones or García (16/09/2004, [C-404/02](#), Nichols, EU:C:2004:538, § 26, 30), and the names of

prominent persons (including heads of state). However, an objection will be raised if the name can **also** be perceived as a non-distinctive term in relation to the goods and services (e.g. 'Baker' for pastry products).

For objection based on titles of books, please see the Guidelines, [Part B, Examination, Section 4, Chapter 4, Descriptive Trade Marks, Paragraph 2.7.2, Titles of books](#).

## 3 Single Letters <sup>14</sup>

### 3.1 General considerations

In its judgment of 09/09/2010, [C-265/09 P](#),  $\alpha$ , EU:C:2010:508, the Court of Justice ruled that, in the case of trade marks consisting of single letters represented in standard characters with no graphic modifications, it is necessary to assess whether the sign at issue is capable of distinguishing the different goods and services in the context of an **examination, based on the facts, focusing on the goods or services concerned** (para. 39).

The Court recalled that, according to [Article 4 EUTMR](#), letters are among the categories of signs of which an European Union trade mark may consist, provided that they are capable of distinguishing the goods or services of one undertaking from those of other undertakings (para. 28), and emphasised that registration of a sign as a trade mark does not require a specific level of linguistic or artistic creativity or imaginativeness on the part of the applicant.

Although acknowledging that it is legitimate to take into account the difficulties in establishing distinctiveness that may be associated with certain categories of trade marks because of their very nature, and that it may prove more difficult to establish distinctiveness for marks consisting of a single letter than for other word marks (para. 39), the Court clearly stated that these circumstances do not justify laying down specific criteria supplementing or derogating from application of the criterion of distinctiveness as interpreted in the case-law (paras 33-39).

As to the burden of proof, the Court stated that, when examining absolute grounds for refusal, the Office is required under [Article 95\(1\) EUTMR](#) to examine, of its own motion, the relevant facts that might lead it to raise an objection under [Article 7\(1\) EUTMR](#) and that that requirement cannot be made relative or reversed to the detriment of the EUTM applicant (paras 55-58). Therefore, it is for the Office to explain, with reasons, why a trade mark consisting of a single letter represented in standard characters is devoid of any distinctive character.

It is therefore necessary to carry out a thorough examination based on the **specific factual circumstances of the case** in order to assess if a given single letter represented in standard characters can function as a trade mark in respect of the

---

<sup>14</sup> This part deals with single letters under [Article 7\(1\)\(b\) EUTMR](#). For single letters under [Article 7\(1\)\(c\) EUTMR](#), see [the Guidelines, Part B, Examination, Section 4, Absolute Grounds for Refusal, Chapter 4, Descriptive Trade Marks \(Article 7\(1\)\(c\) EUTMR\), paragraph 2.8](#).

goods/services concerned. This need for a factual assessment implies that it is not possible to rely on assumptions (such as that consumers are generally not accustomed to seeing single letters as trade marks).

Consequently, when examining single-letter trade marks, generic, unsubstantiated arguments, such as those relating to the availability of signs, should be avoided, given the limited number of letters. The Office is obliged to establish, on the basis of a factual assessment, why the trade mark applied for would be objectionable.

It is therefore clear that the examination of single-letter trade marks should be thorough and stringent, and that each case calls for careful examination of whether a given letter can be considered inherently distinctive for the goods and/or services concerned.

## 3.2 Examples

For instance, in technical domains such as those involving computers, machines, motors and tools, it is more likely that single letters will be perceived as technical, model or catalogue references rather than as indicators of origin, although the fact that this is the case should result from a factual assessment.

Depending on the outcome of the prior examination, a trade mark consisting of a single letter represented in standard characters might be objectionable under [Article 7\(1\)\(b\) EUTMR](#) on the ground that it is devoid of inherent distinctiveness for the goods and/or services concerned or part thereof.

This would be the case, for example, for a trade mark consisting of the single letter 'C' for 'fruit juices', as this letter is commonly used to designate vitamin C. The relevant public would not perceive it as a sign distinguishing the commercial origin of the goods in question.

Another example of lack of distinctiveness would be a single-letter trade mark applied for in respect of the sort of toy cubes used to teach children how to construct words. The individual letters in this example are not being used as a sign to distinguish the commercial origin of the goods in question.

Although in this case there is no direct descriptive relationship between the letters and the goods, a trade mark consisting of a single letter would lack distinctiveness, because, when it comes to toy cubes, consumers are more used to seeing single letters as having either a functional or a utilitarian connotation, rather than as indicators of commercial origin.

However, if it cannot be established that a given single letter is devoid of any distinctive character for the goods and/or services concerned, then it should be accepted, even if represented in standard characters or in a fairly basic manner.



For example, the letter  was accepted in respect of *transport; packaging and storage of goods; travel arrangement* in Class 39 and *services for providing food*

*and drink; temporary accommodation* in Class 43 (30/09/2010, [R 1008/2010-2](#), W (fig.), § 12-21).

For further examples see the Guidelines, [Part B, Examination, Section 4, Absolute Grounds for Refusal, Chapter 4, Descriptive Trade Marks \(Article 7\(1\)\(c\) EUTMR\)](#).

## 4 Slogans: Assessing Distinctive Character

The Court of Justice has ruled that it is inappropriate to apply to slogans stricter criteria than those applicable to other types of signs when assessing their distinctive character (12/07/12, [C-311/11 P](#), Wir machen das Besondere einfach, EU:C:2012:460 and case-law cited).

Advertising slogans are objectionable under [Article 7\(1\)\(b\) EUTMR](#) when the relevant public only perceives them as a mere promotional formula. However, they are deemed to be distinctive if, apart from their promotional function, the public perceives them as an indication of the commercial origin of the goods or services in question.

The Court of Justice has provided the **following criteria** that should be used when assessing the distinctive character of a slogan (21/01/2010, [C-398/08 P](#), Vorsprung durch Technik, EU:C:2010:29, § 47; 13/04/2011, [T-523/09](#), Wir machen das Besondere einfach, EU:T:2011:175, § 37).

An advertising slogan is likely to be distinctive whenever it is seen as more than a mere advertising message extolling the qualities of the goods or services in question because it:

- constitutes a play on words, and/or
- introduces elements of conceptual intrigue or surprise, so that it may be perceived as imaginative, surprising or unexpected, and/or
- has some particular originality or resonance, and/or
- triggers in the minds of the relevant public a cognitive process or requires an interpretative effort.

In addition to the above, the following characteristics of a slogan may contribute towards a finding of distinctiveness:

- unusual syntactic structures;
- the use of linguistic and stylistic devices, such as alliteration, metaphors, rhyme, paradox, etc.

However, the use of unorthodox grammatical forms must be carefully assessed because advertising slogans are often written in a simplified form, in such a way as to make them more concise and snappier (24/01/2008, [T-88/06](#), Safety 1st, EU:T:2008:15, § 40). This means that a lack of grammatical elements such as definite articles or pronouns (THE, IT, etc.), conjunctions (OR, AND, etc.) or prepositions (OF, FOR, etc.) may not always be sufficient to make the slogan distinctive. In 'Safety 1st', the Court considered that the use of '1st' instead of 'FIRST' was not sufficiently unorthodox to add distinctiveness to the mark.



A slogan whose meaning is vague or impenetrable or whose interpretation requires considerable mental effort on the part of the relevant consumers is also likely to be distinctive since consumers would not be able to establish a clear and direct link with the goods and services for which the trade mark is protected.

The fact that the **relevant public is a specialist one** and its degree of attention is higher than average cannot decisively influence the legal criteria used to assess the distinctive character of a sign. As stated by the Court of Justice, ‘it does not necessarily follow that a weaker distinctive character of a sign is sufficient where the relevant public is specialist’ (12/07/12, [C-311/11 P](#), *Wir machen das Besondere einfach*, EU:C:2012:460, § 48).

Moreover, according to well-established case-law from the General Court, the level of attention of the relevant public may be **relatively low** when it comes to promotional indications, whether that public consists of average end consumers or of a more attentive public made up of specialists or circumspect consumers. This finding is applicable even for goods and/or services where the level of attention of the relevant public is generally high, such as financial and monetary services (29/01/2015, [T-609/13](#), *SO WHAT DO I DO WITH MY MONEY*, EU:T:2015:54, § 27; 29/01/2015, [T-59/14](#), *INVESTING FOR A NEW WORLD*, EU:T:2015:56, § 27 and cited case-law).

The following examples show some of the different functions that slogans may serve and the arguments that can support an **objection** under [Article 7\(1\)\(b\) EUTMR](#).

EUTM	Main function	Case No
EUTM No 5 904 438 MORE THAN JUST A CARD for Class 36 <i>(bank, credit and debit            card services)</i>	Customer service statement	<a href="#">R 1608/2007-4</a>
Objected to under <a href="#">Article 7(1)(b) EUTMR</a>  The slogan merely conveys information about the goods and services for which protection is sought. It is the kind of language an English speaker would use to describe a bank card that is a little out of the ordinary. It conveys the notion that the card has welcome features that are not obvious at first sight. The fact that the slogan leaves open what these features are, that is to say, that the mark does not describe a specific service or characteristic of the ‘card’, does not make the mark distinctive.		
EUTM	Main function	Case No

<p>EUTM No 7 394 414</p> <p>WE PUT YOU FIRST. AND KEEP YOU AHEAD</p> <p>for Class 40</p>	<p>Customer service statement</p>	<p>(Examiner's decision without BoA case)</p>
<p>Objected to under <a href="#">Article 7(1)(b) EUTMR</a></p> <p>The mark is a promotional laudatory message, highlighting the positive aspects of the services, namely that they help to procure the best position in the business and maintain this position in the future.</p>		
EUTM	Main function	Case No
<p>EUTM No 6 173 249</p> <p>SAVE OUR EARTH NOW</p> <p>for Classes 3, 17, 18, 20, 22, 24, 25 and 28</p>	<p>Value statement or political motto</p>	<p><a href="#">R 1198/2008-4</a></p>
<p>Objected to under <a href="#">Article 7(1)(b) EUTMR</a></p> <p>The sign is a simple and straightforward appeal to take action and contribute to the Earth's well-being by favouring the purchase of environment-friendly products. Contrary to the appellant's contentions that the word 'now' constitutes an original element since nobody will believe that by purchasing the goods in question they will literally save the Earth now, the word 'NOW' is an emotional word commonly used in marketing to urge consumers to consume, to get what they want without waiting; it is a call to action. The relevant consumer will immediately recognise and perceive the sign as a promotional laudatory expression indicating that the goods represent an environment-friendly alternative to other goods of the same sort, and not as an indication of commercial origin.</p>		
EUTM	Main function	Case No
<p>EUTM No 4 885 323</p> <p>DRINK WATER, NOT SUGAR</p> <p>for Classes 32 and 33</p>	<p>Inspirational or motivational statement</p>	<p><a href="#">R 718/2007-2</a></p>
<p>Objected to under <a href="#">Article 7(1)(b) EUTMR</a></p> <p>The mark is a banal slogan that merely conveys the idea that the consumer will be drinking real water rather than a sugary drink. The mark lacks any secondary or covert meaning, has no fanciful elements, and its message to the consumer is plain, direct and unambiguous. For these reasons, it is unlikely to be perceived as a sign of trade origin. It is easily seen that the mark consists merely of good counsel, namely that it is better from a health point of view to drink water that has not been sugared. What better way to promote such goods than by an expression such as DRINK WATER, NOT SUGAR? Consumers will read this with approval, but will look elsewhere on the product for the trade mark.</p>		

<b>EUTM</b>	<b>Main function</b>	<b>Case No</b>
DREAM IT, DO IT! Classes 35, 36, 41 and 45	Inspirational or motivational statement	02/07/2008, <a href="#">T-186/07</a> , EU:T:2008:244
The relevant English-speaking public will see this as an invitation or encouragement to achieve their dreams and will understand the message that the services covered by that trade mark will allow them to do so.		
<b>EUTM</b>	<b>Main function</b>	<b>Case No</b>
VALORES DE FUTURO for Class 41	Value statement	06/12/2013, <a href="#">T-428/12</a> , EU:T:2013:629
Objected to under <a href="#">Article 7(1)(b) EUTMR</a> The relevant public when confronted with the expression VALORES DE FUTURO will perceive a laudatory message whose only objective is to give a positive view of the services involved.		
<b>EUTM</b>	<b>Main function</b>	<b>Case No</b>
INVESTING FOR A NEW WORLD Classes 35 and 36	Value statement	29/01/2015, <a href="#">T-59/14</a>
Objected to under <a href="#">Article 7(1)(b) EUTMR</a> The sign INVESTING FOR A NEW WORLD, considered as a whole, may be easily understood by the relevant public, in view of the common English words of which it consists, as meaning that the services offered are intended for a new world's needs. Given that the services covered by the mark applied for are all related to activities connected with finance and have a close link with the word 'investing', the Board of Appeal was right to find that the message conveyed by the expression 'investing for a new world' was that, when purchasing the services in question, the money or capital invested created an opportunity in a new world, which carried a positive connotation. The Court also found that the fact that the expression at issue could be interpreted in a number of ways did not alter its laudatory nature.		
<b>EUTM</b>	<b>Main function</b>	<b>Case No</b>
SO WHAT DO I DO WITH MY MONEY Classes 35 and 36	Value statement	29/01/2015, <a href="#">T-609/13</a>

<p>Objected to under <a href="#">Article 7(1)(b) EUTMR</a></p> <p>The expression ‘so what do I do with my money’ prompts consumers to ask themselves what they should do with their financial resources and assets. In the present case, the average reasonably well-informed and reasonably observant and circumspect consumer of the services covered by the application for registration will, on reading or hearing that expression, wonder whether he or she is using his or her money effectively.</p>		
EUTM	Main function	Case No
PIONEERING FOR YOU Classes 7, 9, 11, 37 and 42	Value statement	12/12/2014, <a href="#">T-601/13</a> , EU:T:2014:1067
<p>Objected to under <a href="#">Article 7(1)(b) EUTMR</a></p> <p>The sign would be understood as ‘innovative for you’. The meaning of the sign is clear and does not leave any doubts. The structure of the sign is grammatically correct and does not trigger any mental process in order to arrive at its meaning. It is, as a whole, a simple message that could be attributed to any producer or service provider with the natural consequence that it does not indicate the origin of the goods or services</p>		

### Some examples of accepted slogans

EUTM	Classes	Case No
SITEINSIGHTS	Classes 9 and 42	<a href="#">R 879/2011-2</a> , EUTM No 9 284 597
<p>The mark ‘SITEINSIGHTS’ shows some degree of originality and expressiveness, which makes it easy to remember. It contains a play on words as the word ‘SITE’ and the ‘SIGHT’ element of ‘INSIGHTS’ are pronounced identically.</p>		
EUTM	Classes	Case No
WET DUST CAN'T FLY	Classes 3, 7 and 37	22/01/2015, <a href="#">T-133/13</a> , EU:T:2015:46
<p>The concept of ‘wet dust’ is literally inaccurate, since dust is no longer dust when it is wet. Consequently, the juxtaposition of those two words gives that concept a fanciful and distinctive character.</p>		
EUTM	Classes	Case No
LOVE TO LOUNGE	Class 25	15/09/2017, <a href="#">T-305/16</a> , EU:T:2017:607

When the mark is used in relation to the goods in question, namely clothing, footwear and items of headgear, the relevant public will have to place that mark in a certain context, which requires an intellectual effort. The contested mark will enable consumers to identify the commercial origin of the goods at issue. Consequently, that mark has inherent distinctive character.

A slogan is objectionable under [Article 7\(1\)\(c\) EUTMR](#) if it immediately conveys information about the kind, quality, intended purpose or other characteristics of the goods or services (see the Guidelines, [Part B, Examination, Section 4, Absolute Grounds for Refusal, Chapter 4, Descriptive Trade Marks \(Article 7\(1\)\(c\) EUTMR\)](#)).



## 5 Simple Figurative Elements

Simple geometric devices such as circles, lines, rectangles or common pentagons are unable to convey any message that can be remembered by consumers and will accordingly not be seen by them as a trade mark.

As set out by the Court, an extremely simple sign, composed of a basic geometric figure such as a circle, a line, a rectangle or a pentagon is not capable, as such, of conveying a message that consumers can remember, with the result that they will not consider it as a trade mark (12/09/2007, [T-304/05](#), Pentagon, EU:T:2007:271, § 22).

### Examples of refused trade marks

Sign	Goods and services	Reasoning	Case No
	Class 33	The sign consists merely of a normal pentagon, a simple geometric figure. The geometric form, if it happened to be the form of the label, would be perceived as having a functional or aesthetic purpose rather than an origin-indicating function.	12/09/2007, <a href="#">T-304/05</a> , Pentagon

Sign	Goods and services	Reasoning	Case No
	Classes 9, 14, 16, 18, 21, 24, 25, 28, 35-39, 41-45	The sign will be perceived as an excessively simple geometric shape, essentially as a parallelogram. To fulfil the identification function of a trade mark, a parallelogram should contain elements that singularise it in relation to other parallelograms' representations. The two characteristics of the sign are the fact that it is slightly inclined towards the right and that the base is slightly rounded and elongated towards the left. The general consumer would not perceive such nuances.	13/04/2011, <a href="#">T-159/10</a> , Parallélogramme, EU:T:2011:176
	Classes 14, 18, 25	The sign does not contain any elements that may be easily and instantly memorised by an attentive relevant public. It will be perceived only as a decorative element, regardless of whether it relates to goods in Class 14 or to those in Classes 18 and 25.	29/09/2009, <a href="#">T-139/08</a> , Smiley, EU:T:2009:364



Sign	Goods and services	Reasoning	Case No
	<p>Classes 3, 18, 24, 43, 44</p>	<p>The sign consists of merely a simple geometric figure in green. The specific colour is commonly and widely used in advertising and in marketing goods and services because of its power to attract without giving any precise message.</p>	<p>09/12/2010, <a href="#">T-282/09</a>, Carré convexe vert, EU:T:2010:508</p>

Sign	Goods and services	Reasoning	Case No
	<p>Classes 3, 5, 16, 18, 25, 28, 35</p>	<p>Relying on the applicable case-law, that simple geometric shapes cannot, in and of themselves, convey content that consumers could permanently remember and in consequence perceive such shapes or figures as fulfilling the function of trade marks (12/09/2007, <a href="#">T-304/05</a>, Pentagon, EU:T:2007:271, § 22), the Board concluded that the same applies in the case at hand, where the mark consists not of one, but of three basic geometric shapes placed on one row and forming a simple sequence of shapes. (§ 16)</p> <p>The Board found that in case of <i>everyday goods</i> such as <i>cosmetics, foodstuffs, stationery, clothing and accessories</i>, as well as <i>games and toys, publications, books and magazines</i> in Classes 3, 5, 16, 18, 25 and 28, as well as for <i>specialist office machines</i> in Class 16 and <i>retail and wholesale services</i> in Class 35, regardless of the attention paid by the consumers at the moment of purchase, consumers will not be able to refer to a series of simple blue geometric shapes as a trade mark and memorise such sign</p>	<p>14/11/2017, <a href="#">R 1028/2017-5</a></p>

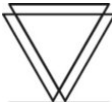

Sign	Goods and services	Reasoning	Case No
	<p>Classes 8, 14, 21</p>	<p>The trade mark in question consists of an elongated oval with a forward slash above it. Taken as a whole, this is an extremely simple figurative sign, and none of the elements have any unusual features in themselves. It only departs from a regular geometric oval shape insofar as the top curve is slightly wider than the bottom curve. This is, however, barely noticeable when simply looking at the sign and, in any case, does not prevent the geometric design from remaining simple (para. 15).</p> <p>In the present case, distinctive character is not possessed by the simple shape of the oval, the simple line above it or the two together. Taken together, it is a banal designation which, owing to the simplicity thereof, is not capable, on its own, of being perceived by the relevant public as an indication that enables the commercial origin of the goods at issue to be identified without any likelihood of confusion with goods of a different origin (para. 17).</p>	<p>09/12/2015,  <a href="#">R 340/2015-1</a></p>

Example of an accepted trade mark

Sign	Goods and services	Reasoning	EUTM No
	Classes 35, 41	The sign gives the impression of overlapping triangles, but this is actually just an illusion formed by one single line. It is not a simple juxtaposition of basic shapes, but rather a creative arrangement of lines giving a distinctive overall impression.	EUTM No 10 948 222
	Classes 1, 5, 40, 42, 45	The figure applied for is not so simple that it can be denied registration. It is certainly restrained in detail in its execution, but taken in its entirety it is neither a simple geometric figure, nor a mark that is entirely banal for the purposes of trade mark law. As noted by the applicant, the mark can be interpreted in different ways, e.g. as a stylised letter 'X' or as two arrows pointing towards each other (para. 21).	28/09/2015, <a href="#">R 1953/2014-2</a>

	Classes 4, 7, 12, 37, 42	<p>The sign consists of two parallelograms in grey-scale, one next to the other, placed on a white background. Altogether they form something definitely more than a simple geometric shape. Bearing in mind the nature of the goods and services at issue (<i>oils, greases</i> in Class 4, <i>engines, generators</i> in Class 7, <i>vehicles</i> in Class 12, <i>installation services</i> in Class 37 and <i>design</i> in Class 42) the sign will be seen as something more than a mere decorative element. The sign has a minimum degree of distinctive character.</p>	EUTM No 1 457 644
---	--------------------------	--	-------------------

Further examples of simple figurative elements (combined with non-distinctive/descriptive terms) can be found in the Guidelines, [Part B, Examination, Section 4, Absolute Grounds for Refusal, Chapter 4, Descriptive Trade Marks \(Article 7\(1\)\(c\) EUTMR\)](#).

## 6 Commonplace Figurative Elements

In some cases, the figurative element consists of a representation of the goods and services for which the trade mark is protected. In principle, the said representation is considered to be descriptive and/or devoid of distinctive character whenever it is a true-to-life portrayal of the goods and services or when it consists of a symbolic/stylised portrayal of the goods and services that does not depart significantly from the common representation of the said goods and services.

In other cases, the figurative element might not represent the goods and services but might still have a direct link with the characteristics of the goods and/or services. In such cases, the sign will be considered non-distinctive, unless it is sufficiently stylised.

The following representation of a vine leaf is not distinctive for *wine*:



Similarly, the following representation of a cow for *milk products* is not distinctive:



EUTM No 11 345 998, claiming Classes 29 (*milk* and *milk products*, etc.) and 35.

The above sign was refused, as representations of cows are commonly used in relation to *milk* and *milk products*. The fact that the subject mark consists of an ‘aerial’ picture of a cow is not sufficient to confer distinctive character on the sign, as slight alterations to a commonplace sign will not make that sign distinctive. The same reasoning would be applicable also to related goods such as *milk chocolate*.

Further examples of common figurative elements (combined with non-distinctive/descriptive terms) can be found in [the Guidelines, Part B, Examination, Section 4, Absolute Grounds for Refusal, Chapter 4, Descriptive Trade Marks \(Article 7\(1\)\(c\) EUTMR\)](#).

## 7 Typographical Symbols

Typographical symbols such as a full stop, comma, semicolon, quotation mark or exclamation mark will not be considered by the public as an indication of origin. Consumers will perceive them as a sign meant to catch the consumer’s attention but not as a sign that indicates commercial origin. A similar reasoning applies to common currency symbols, such as the €, £, \$ signs; depending on the goods concerned, these signs will only inform consumers that a specific product or service is traded in that currency.

Examples of refused trade marks

Sign	Goods and services	Reasoning	EUTM No
	Classes 14, 18 and 25	<p>The GC confirmed the finding of the BoA that the trade mark applied for is devoid of the necessary degree of distinctive character. It consists merely of a punctuation mark with no special additional features immediately apparent to customers, and is a commonplace sign that is frequently used in business or in advertising. In view of its frequent use, the relevant consumer will see the exclamation mark as being merely laudatory advertising or something to catch the eye (30/09/2009, <a href="#">T-75/08</a>!, EU:T:2009:374).</p>	EUTM No <a href="#">5 332 184</a>

Sign	Goods and services	Reasoning	EUTM No
	Classes 29, 30, 31 and 32	<p>The sign applied for was refused because, in the case of the goods for which the trade mark is protected (foodstuffs and beverages), percentages are particularly important in relation to the price. For example, the percentage sign indicates clearly that there is a favourable cost/benefit ratio because the price has been reduced by a particular percentage in comparison with the normal price. Such a percent sign in a red circle is also frequently used in connection with clearance sales, special offers, stock clearances or cheap no-name products, etc. The consumer will regard the sign merely as a pictogram conveying the information that the goods for which the trade mark is protected are sold at a reduced price (16/10/2008, <a href="#">R 998/2008-1</a> , Percent sign (fig.)).</p>	EUTM No <a href="#">5 649 256</a>

## 8 Pictograms

Pictograms are basic and unornamented signs and symbols that will be interpreted as having purely informational or instructional value in relation to the goods or services

concerned. Examples would be signs that indicate mode of use (like a picture of a telephone in relation to *pizza delivery* services) or that convey a universally understandable message (like a knife and fork in relation to *the provision of food*).

Commonly used pictograms, for example, a white 'P' on a blue background to designate a parking place (this sign could also be objectionable under [Article 7\(1\)\(d\) EUTMR](#)) or the design of an ice cream to designate that ice cream is sold in the vicinity, are not distinctive in relation to the goods or services in respect of which they are used. Moreover, if the pictogram immediately conveys information about the kind, quality, intended purpose or other characteristics of the goods or services, it will also be objectionable under [Article 7\(1\)\(c\) EUTMR](#) (20/07/2016, [R 2345/2015-4](#), PICTOGRAM OF A DROP OF LIQUID AND OF THREE DIRECTIONAL ARROWS (fig.)).



#### Examples of refused trade marks

Sign	Reasoning	Case No
	<p>Taking into account the kind of goods and services for which protection is sought in Classes 9, 35, 36, 38 and 42 (for example, cash dispensers, banking services), the public will see the sign as a practical indication or as directional arrows showing where the magnetic card has to be inserted into the distributor. The association of the triangles with the other elements of the trade mark applied for means that the public concerned will perceive them as directional arrows. Consumers see this type of practical information every day in all kinds of places, such as banks, supermarkets, stations, airports, car parks, telephone boxes, etc. (paras 37-42).</p>	<p>02/07/2009, <a href="#">T-414/07</a>, Main tenant une carte, EU:T:2009:242</p>



Sign	Reasoning	Case No
 <p>EUTM No 9 894 528 for goods in Class 9</p>	<p>This sign was refused as it is identical to the core of the international safety symbol for 'high voltage' or 'caution, risk of electric shock'. The device applied for, within the triangle denoting a hazard symbol, has been officially defined by ISO 3864 as the standard high voltage symbol. Because this sign essentially coincides with the customary international sign to indicate a risk of high voltage, it was refused, inter alia, under <a href="#">Article 7(1)(b) and (d) EUTMR</a>.</p>	<p>21/09/2012, <a href="#">R 2124/2011-5</a>, DEVICE OF LIGHTNING BOLT(fig.)</p>



Sign	Reasoning	Case No
 <p data-bbox="236 1064 319 1093">Class 9</p>	<p data-bbox="614 291 933 320">Refused for goods in Class 9.</p> <p data-bbox="614 347 981 1142">It is a well-known fact that a great variety of software applications are available for mobile phones, tablet computers, standard computers or other digital electronic devices, and that such applications, once they are installed, are often represented by a symbol (icon) that makes the application easily accessible for its user. Such symbols can be designed in various ways, ranging from a simple image of a clock, camera or a book, which will represent the nature of the underlying software application, to an arbitrary symbol and/or a trade mark that in itself does not reveal anything about the software it is used for (para. 18).</p> <p data-bbox="614 1176 981 1646">The inclusion of a person's silhouette on a square shaped background is a natural way of designing icons that, when used in mobile phones, tablet computers, standard computers or other digital electronic devices, will be seen as representing an application for managing contact information, such as telephone numbers and/or addresses (para. 19 et seq.).</p>	<p data-bbox="997 896 1125 925">25/01/2016,</p> <p data-bbox="997 952 1157 981"><a href="#">R 1616/2015-5</a>,</p> <p data-bbox="997 1008 1141 1037">A B C D (fig.)</p>

Sign	Reasoning	Case No
 <p>Classes 9 and 38</p>	<p>Refused for goods in Class 9 and services in Class 38.</p> <p>An email system running on a computer or handheld device (e.g. tablet or mobile phone) must use 'icons' to represent the current status of an application or operation. There is no more apt 'icon' - which is nothing more than a small graphic representation of a program or file - to represent an electronic message than an envelope. The 'tick' indicates that something has been done correctly or that something has been checked (paras 16 and 17). It is well known what these kind of icons look like (para. 19).</p>	<p>05/04/2016,  <a href="#">R 2256/2015-2</a>,                      DEVICE OF AN OPEN ENVELOPE WITH A CHECK SIGN (fig.)</p>
	<p>Refused for goods in Class 9.</p> <p>The public will encounter this used as a pictogram on a mobile phone, computer, tablet or similar to indicate access to a program or application that allows the user to make notes or write text. Some of these applications convert handwriting into typewritten text.</p>	<p>EUTM No 12 717 914</p>

Example of accepted trade marks

Sign	Reasoning	EUTM No
	<p>Accepted for goods and services in Classes 9 and 43.</p> <p>The representation, which could be perceived as an image of a stool, does not have any direct discernible meaning in relation to the goods and services at issue.</p>	<p>EUTM No 16 314 494</p>
	<p>Accepted for goods and services in Classes 9, 24, 25 and 28.</p> <p>The sign has a complex design. The representation is very abstract and not naturalistic. What may appear to be a head consists only of a circle, which is separated from the body (which, as is well known, is not the case in nature), and the representation of the rest of the body does not correspond to a realistic arrangement and combination of human legs, arms and torso. Only at an abstract level can a swimmer on the point of diving be discerned (para. 15).</p> <p>It is true that the clothing for which protection is sought and the other goods claimed can be used, or even are expressly used, for swimming. If the sign applied for were applied to such goods, it could be argued that it would be perceived as an indication that the goods were suitable for bathing. However, the meaning of the sign applied for is not specific enough for this, as it is intended only to symbolise a human being and not a product. (para. 20).</p>	<p>05/03/2018,  <a href="#">R 1759/2017-4</a></p>

## 9 Common/Non-Distinctive Labels

A figurative sign may be composed of shapes, designs or figures that will be perceived by the relevant public as non-distinctive labels. In this case, the reason for the refusal lies in the fact that such figurative elements are not capable of impressing themselves on the consumer's mind, since they are too simple and/or commonly used in connection with the goods/services for which protection is sought.

See the following examples:

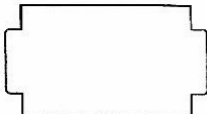
Sign	Reasoning	Case No
 <p>EUTM No 4 373 403, filed as a three-dimensional mark claiming protection for goods in Class 16 (<i>Adhesive labels; adhesive labels for use with hand labelling appliances; and labels (not of textile)</i>)</p>	<p>The mark applied for is 'devoid of any distinctive character' and was refused under <a href="#">Article 7(1)(b) EUTMR</a> as it is as banal and ordinary as it is possible to get in relation to adhesive labels. The sign says a lot about the nature of the goods and very little, if anything, about the identity of the producer (para. 11).</p>	<p>22/05/2006, <a href="#">R 1146/2005-2</a>, LABEL SHAPE (3D)</p>

Sign	Reasoning	Case No
 <p>EUTM No 9 715 319 for goods in Classes 6, 7, 8, 9 and 20</p>	<p>The mark was refused, as its basic shape combined only with a bright yellow colour could not, in the minds of the relevant professional and general public, serve to distinguish the goods for which protection was sought as originating from a particular undertaking. Here, the colour yellow may be perceived as a decoration for the goods, as well as for the purpose of attracting attention to the goods, without giving any specific information or precise message as to the commercial origin of the goods. In addition, as is generally known, bright yellow is commonly used in a functional way in relation to a wide range of goods, that is, inter alia, for increasing the visibility of objects, highlighting or warning. For these reasons, the relevant consumers will not recognise this colour as a trade mark, but will perceive it as an alert or decoration.</p>	<p>15/01/2013, <a href="#">R 444/2012-2</a>, DEVICE OF A LABEL IN COLOUR YELLOW (fig.)</p>

In the same way, the following marks were rejected.

 <p>EUTM No 11 177 912 claiming Classes 29, 30 and 31</p>	 <p>EUTM No 11 171 279 claiming Classes 29, 30 and 31</p>	 <p>EUTM No 10 776 599 claiming, inter alia, goods in Classes 32 and 33</p>
--	--	--

In the three preceding cases, both the colour and the shape of the labels are quite commonplace. The same reasoning applies to the stylised representation of the fruits in the last of the three cases. Furthermore, the said figurative element represents or at

least strongly alludes to the ingredients of some of the claimed goods, such as, for example, *fruit juices*.

## 10 Shape Marks

### 10.1 Preliminary remarks

[Article 3\(3\)\(c\) EUTMIR](#) defines shape marks as trade marks consisting of, or extending to, a three-dimensional shape, including containers, packaging, the product itself or their appearance. The term 'extending to' means that these marks cover not only shapes per se but also shapes that contain word or figurative elements such as logos or labels.

[Article 7\(1\)\(b\) EUTMR](#) does not distinguish between different categories of trade marks in determining whether a trade mark is capable of distinguishing the goods or services of one undertaking from those of other undertakings (05/03/2003, [T-194/01](#), Soap device, EU:T:2003:53, § 44). In applying this uniform legal standard to different trade marks and categories of trade marks, a distinction must be made depending on consumer perception and market conditions. For signs consisting of the shape of the goods themselves, no stricter criteria apply than for other marks, but it may be more difficult to come to a finding of distinctiveness, as such marks will not necessarily be perceived by the relevant public in the same way as a word or figurative mark (07/10/2004, [C-136/02 P](#), Torches, EU:C:2004:592, § 30).



Shape marks can be grouped into three categories:

- shapes unrelated to the goods and services themselves;
- shapes that consist of the shape of the goods themselves or part of the goods;
- the shape of packaging or containers.

### 10.2 Shapes unrelated to the goods or services themselves

Shapes that are unrelated to the goods or services themselves (e.g. the Michelin Man) are usually distinctive.

*Accepted trade marks*

Sign	Reasoning	EUTM No
	<p>Registered for goods in Classes 16 and 21</p> <p>The sign is clearly different to what is commonly expected for the corresponding goods (paper, rolls of paper for household use, kitchen utensils and containers, etc.).</p>	<p><b>EUTM No 1 705 367</b></p>
	<p>Registered for goods in Classes 36, 39 and 42, (insurance and financial services, rental and leasing of vehicles, and leasing of commercial and industrial equipment).</p> <p>The shape is unrelated to the goods and services and therefore perfectly capable of distinguishing them.</p>	<p><b>EUTM No 715 524</b></p>

### 10.3 Shape of the goods themselves or shapes related to the goods or services; shape of the packaging or containers

The case-law developed for three-dimensional marks that consist of the representation of the shape of the product itself is also relevant for figurative marks consisting of two-dimensional representations of the product or elements of it (14/09/2009, [T-152/07](#), Uhr, EU:T:2009:324; 04/05/2017, [C-417/16 P](#), DEVICE OF A SQUARE-SHAPED PACKAGING (fig.), EU:C:2017:340).

In the framework of the European Union Intellectual Property Network (EUIPN), the Office and a number of trade mark offices in the European Union have agreed on a [Common Practice in relation to the distinctiveness of three-dimensional marks \(shape marks\) containing verbal and/or figurative elements when the shape is not distinctive](#) in itself (also referred to as Convergence Project 9 or CP9 Practice). The common principles are detailed below under [point 10.3.1](#).

For a shape that is the shape or packaging of the goods applied for, the examination should be conducted in the following steps.

- Step 1: [Article 7\(1\)\(e\) EUTMR](#) analysis
- Step 2: Assessment of the distinctiveness of the shape itself
- Step 3: Identification of the elements of the shape mark

- Step 4: Assessment of the distinctiveness of the sign as a whole

Step 1: [Article 7\(1\)\(e\) EUTMR](#) analysis

The examiner should first examine whether one of the grounds for refusal under [Article 7\(1\)\(e\) EUTMR](#) applies, as those cannot be overcome through acquired distinctiveness. With regard to this first step, see the Guidelines, [Part B, Examination, Section 4, Absolute Grounds for Refusal, Chapter 6: Shapes or Other Characteristics with an Essentially Technical Function, Substantial Value or Resulting from the Nature of the Goods \(Article 7\(1\)\(e\) EUTMR\)](#).

Step 2: assessment of the distinctiveness of the shape itself

The criteria for **distinctiveness of the shape itself** must be checked. The basic test is whether the shape is so materially different from basic, common or expected shapes that it enables a consumer to identify the goods just by their shape and to buy the same item again if he or she has had positive experiences with the goods. Frozen vegetables in the form of a crocodile are a good example of this.

The following criteria are relevant when examining the distinctiveness of shape trade marks consisting exclusively of the shape of the goods themselves.

- A shape is non-distinctive if it is a basic shape (19/09/2001, [T-30/00](#), red-white squared washing tablet (fig.), EU:T:2001:223) or a combination of basic shapes (13/04/2000, [R 263/1999-3](#), Tönnchen (3D)).
- To be distinctive, the shape must depart significantly from the shape that is expected by the consumer, and it must depart significantly from the norm or customs of the sector. The more closely the shape resembles the shape that is most likely to be taken by the product in question, the greater the likelihood that it is not distinctive (07/10/2004, [C-136/02 P](#), Torches, EU:C:2004:592, § 31).
- It is not enough for the shape to be just a variant of a common shape or a variant of a number of shapes in an area where there is a huge diversity of designs (07/10/2004, [C-136/02 P](#), Torches, EU:C:2004:592, § 32; 07/02/2002, [T-88/00](#), Torches, EU:T:2002:28, § 37).
- Functional shapes or features of a shape mark will be perceived by the consumer as such. For example, for washing tablets, bevelled edges avoid damage to laundry, and layers of different colours represent the presence of different active ingredients.

While the public is accustomed to recognising a shape mark as an indicator of source, this is not necessarily the case where the three-dimensional sign is indistinguishable from the product itself. Consequently, an assessment of distinctive character cannot result in different outcomes for a shape mark consisting of the design of the product itself and for a figurative mark consisting of a faithful representation of the same product (19/09/2001, [T-30/00](#), red-white squared washing tablet (fig.), EU:T:2001:223, § 49).

Step 3: identification of the elements of the shape mark

In the third step, the examiner should assess whether the representation of the shape mark extends to any other elements that might give the trade mark distinctive character. As explained below, Convergence Project 9 has established certain



principles about how those elements will be perceived depending on several factors. These principles apply to Step 3 and Step 4 (see below).

#### Step 4: assessment of the distinctiveness of the sign as a whole

The assessment of distinctiveness must be based on the overall impression of the combination of the shape and the elements to which it extends, in relation to the goods in question, and considering the consumer's perception which can be influenced by specific market realities.

#### 10.3.1 Elements and factors affecting the distinctiveness of the sign as a whole when the shape is non-distinctive (CP9)

As a starting point, if a non-distinctive shape contains an element that is distinctive on its own, it will suffice to render the sign as a whole distinctive.

However, non-distinctive elements or descriptive elements combined with a standard shape will not confer distinctiveness to the sign (18/01/2013, [T-137/12](#), Vibrator, EU:T:2013:26, § 34-36).

The Office will identify all the elements to which the shape mark extends and their inherent distinctiveness:

- verbal and figurative elements;
- colours (single and colour combinations);
- a combination of the above.

Where the shape extends to verbal/figurative elements, their identification and assessment of distinctiveness should include consideration of the following factors:

- size/proportion of the elements with respect to the shape;
- contrast of the element with respect to the shape;
- position of the element on the shape.

Where a shape extends to colour and colour combinations, their identification and assessment of distinctiveness should include consideration of the particular arrangement of colours on the specific shape.

##### 10.3.1.1 Verbal and figurative elements

The **size and proportion** of the verbal/figurative elements, their **contrast** with respect to the shape, and their actual **position** on it, are all factors which may affect the perception of the sign when assessing its distinctiveness.

##### 10.3.1.1.1 Size/Proportion

The size and proportion of the elements must be taken into account when assessing the distinctive character of a shape mark. The assessment is first and foremost based on the representation of the sign, as submitted by the applicant, regardless of the usual size of the product. The distinctive element must be clearly visible in the representation

to render the sign distinctive as a whole. No specific proportions between the elements and the shape are required.

When the verbal/figurative element is sufficiently large to be clearly identified as distinctive, and has sufficient impact on the overall impression given by the sign, it renders the sign as a whole distinctive.

**Distinctive example**

Sign	Comments	Example
 <p data-bbox="233 853 598 920">Class 9 Secure digital memory cards</p>	<p data-bbox="614 571 979 884">Despite the very small size of this type of memory cards, the verbal element is large in proportion to the shape and can clearly be identified as a distinctive element in the representation, thus rendering the sign as a whole distinctive.</p>	<p data-bbox="995 734 1141 763">CP9 example</p>

When the element is **large**, but identified as non-distinctive, its size alone, in proportion to the shape, will not be sufficient to render the sign as a whole distinctive.

**Non-distinctive example**

Sign	Comments	Example
 <p data-bbox="233 1458 435 1487">Class 3 Cosmetics</p>	<p data-bbox="614 1247 979 1561">In this example, despite the large non-distinctive verbal element on the non-distinctive shape, the sign is not distinctive as a whole. It contains descriptive information about the goods in question on a simple geometrical shape, which is also non-distinctive.</p>	<p data-bbox="995 1247 1141 1276">CP9 example</p>

**Specific market realities** must also be taken into consideration. Consumers are in the habit of identifying small elements on certain goods, in which case, relatively small-sized elements may still have a sufficient impact to render the sign as a whole distinctive, as long as their size still allows them to be clearly identified as distinctive.

**Distinctive examples**

Sign	Comments	Example
 <p data-bbox="236 539 595 607">Class 18 Business card holders, in the nature of card cases</p>	<p data-bbox="616 293 978 763">Small badges of origin are commonly used for goods such as business card holders or watches. Therefore, despite the small size of the verbal elements in proportion to the non-distinctive shapes, the sign as a whole is distinctive as the verbal elements can be identified as distinctive elements in the representation, rendering the sign as a whole distinctive.</p>	<p data-bbox="997 730 1153 757">CP9 examples</p>
 <p data-bbox="236 1173 432 1200">Class 14 Watches</p>		
 <p data-bbox="236 1480 408 1507">Class 12 Trucks</p>	<p data-bbox="616 1232 978 1547">In this specific segment, badges of origin are usually relatively small in proportion to the goods. The fairly small size of the verbal element in proportion to the truck does not prevent it from being clearly identified as a distinctive element.</p>	<p data-bbox="997 1379 1144 1406">CP9 example</p>

When the verbal/figurative element is small to the point it is not identifiable as distinctive, it will not have a sufficient impact on the overall impression and therefore will not render the shape as a whole distinctive.

**Non-distinctive examples**

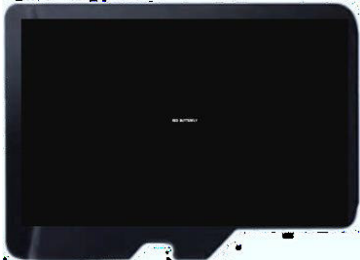
Sign	Comments	Example
 <p data-bbox="233 1344 391 1368">Class 33 Wine</p>	<p data-bbox="614 293 979 640">In these examples, the verbal/figurative elements are so small that they cannot be identified in the representation and their distinctiveness cannot be determined. Therefore, they do not have sufficient impact on the overall impression and the sign as a whole is non-distinctive.</p>	<p data-bbox="995 1010 1153 1034">CP9 examples</p>
 <p data-bbox="233 1691 600 1760">Class 9 Secure digital memory card</p>		

Sign	Case No
	R 1511/2013-2 (26/11/2015, <a href="#">T-390/14</a> , JK KANGOO JUMPS XR, EU:T:2015:897)
<p>BoA confirmed that the figurative element 'KANGOO JUMPS' (in both the upper and lower spring layers) and the letters 'KJ' and 'XR' (at the ends of the intermediate elastic plastic straps) could only be seen with great difficulty or not at all. Parts such as these, which can only be noticed on close inspection, are, in general, not to be perceived as an indication of origin (para. 29).</p> <p>The GC confirmed the BoA decision, stating that '... the word and figurative elements of the mark ... are extremely minor ... and, therefore ... of such a superficial nature that they do not bring any distinctive character to the mark applied for as a whole.' (para. 27)</p>	

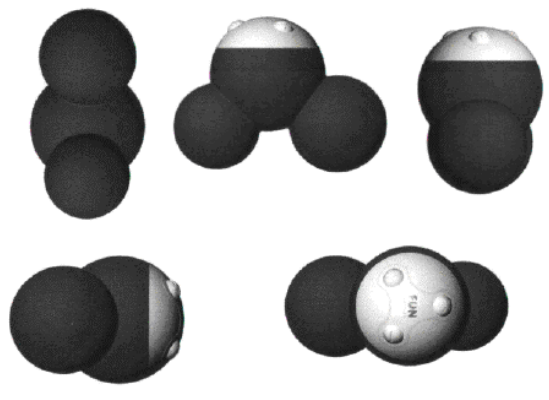
Sign	Case No
	18/01/2013, <a href="#">T-137/12</a> , Vibrator, EU:T:2013:26
<p>The Court considered that the descriptive element 'fun' could not confer distinctiveness on the 3D sign. Moreover, the BoA was right not to take into account the element 'factory' written above the word 'fun', as it was illegible in the application (para. 34 et seq.).</p>	

### 10.3.1.1.2 Contrast

The use of contrast can also affect the capacity of the verbal/figurative element(s) to be identified, and ultimately to render the sign distinctive as a whole. Contrast can be

achieved by the use of different shades of colours or by embossing/engraving/debossing certain elements on the specific goods.

1. Colour contrast

The use of less contrasting colours can still be sufficient to allow an element to be identified as distinctive in the representation and result in a distinctive sign.

**Distinctive examples**

Sign	Comments	Example
 <p data-bbox="272 1644 432 1671">Class 33 Wine</p>	<p data-bbox="639 629 991 936">Despite the use of less contrasting colours, the figurative element on the bottle is still capable of conferring distinctive character to the sign as a whole as the element can clearly be identified as distinctive in the representation.</p>	<p data-bbox="1007 1137 1150 1164">CP9 example</p>

Sign	Comments	Example
 <p data-bbox="272 801 608 831">Class 32 Bottled drinking water</p>	<p data-bbox="639 293 991 600">Despite the use of less contrasting colours between the verbal element and the bottle, the first can still be identified as distinctive, therefore, the overall impression results in the sign being perceived as distinctive as a whole.</p>	<p data-bbox="1007 546 1150 575">CP9 example</p>

On the contrary, when the element cannot clearly be identified as distinctive in the representation due to a **lack of contrast**, the element will have no impact on the assessment of the distinctiveness of the sign as the consumer will not be able to immediately identify this element and ultimately distinguish the sign from others.

**Non-distinctive examples**

Sign	Comments	Example
 <p data-bbox="272 1581 512 1610">Class 28 Playing balls</p>	<p data-bbox="639 1270 991 1621">In this case, the element (the gorilla, indicated by the arrow for clarity purposes only) cannot be clearly identified without close inspection due to a lack of contrast between the element and its background. The combination does not render the sign as a whole distinctive.</p>	<p data-bbox="1007 1431 1150 1460">CP9 example</p>



2. Engraving/Embossing/Debossing

Due to their nature, the colour of **engravings** (action of cutting or carving (a text or design) on the surface of a hard object), **embossings** (action of carving, moulding, or stamping a design on a surface or object so it stands out in raised relief) and **debossings** (action of carving, moulding, or stamping a design on (a surface or object) so that it stands out in recessed relief) might blend in with the product,

making them harder to perceive and be identified. Nevertheless, engravings are frequently used to distinguish shape marks.

The effect of engraving/embossing/debossing may influence the identification of the element and the overall assessment of the distinctiveness of the sign.

**Distinctive examples**

Sign	Comments	Example
 <p data-bbox="272 1480 491 1509">Class 32 Beverages</p>	<p data-bbox="639 573 991 763">The embossed element can be identified as distinctive in the representation and therefore, the sign is distinctive as a whole.</p>	<p data-bbox="1007 1025 1155 1055">CP9 example</p>
 <p data-bbox="272 1935 512 1964">Class 16 Pencil boxes</p>	<p data-bbox="639 1547 991 1738">The engraved element can also be identified as distinctive in the representation shown, therefore, the sign is distinctive as a whole.</p>	<p data-bbox="1007 1742 1155 1771">CP9 example</p>

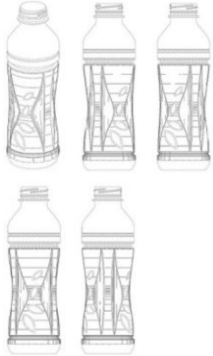

Sign	Comments	Case No
 <p data-bbox="272 674 475 703">Classes 29, 30, 32</p>	<p data-bbox="639 293 743 322">Accepted</p>	<p data-bbox="1007 483 1241 512">EUTM No 12 485 702</p>

**Non-distinctive examples**

Sign	Comments	Example
 <p data-bbox="272 1267 453 1296">Class 11 Toaster</p>	<p data-bbox="639 965 991 1238">The engraved figurative element does not have enough contrast with respect to the shape and therefore cannot be clearly identified in the representation. It therefore cannot render the sign as a whole distinctive.</p>	<p data-bbox="1007 1122 1155 1151">CP9 example</p>

In principle, the fact of engraving/embossing/debossing a non-distinctive element on a non-distinctive shape is not in itself sufficient to render a sign distinctive.

Sign	Comments	Example
 <p data-bbox="272 1384 608 1417">Class 32 Bottled drinking water</p>	<p data-bbox="639 286 991 723">This non-distinctive element (simple geometric shape – circle) which has been engraved on the non-distinctive shape does not bring distinctiveness to the sign as a whole. The overall impression is non-distinctive as the consumer will not be able to distinguish this good as originating from a specific undertaking.</p>	<p data-bbox="1007 835 1358 869">CP9 example</p>



Sign	Comments	Cases
	<p>It is a well-known fact that bottles usually contain lines and creases on them. The relief at the top is not sufficiently striking and will be perceived as a mere decorative element. As a whole, the combination of the elements is not sufficiently distinctive. The average consumer of the goods in Class 32 would not consider the shape as an indicator of origin of the goods in Class 32.</p>	<p>19/04/2013, <a href="#">T-347/10</a>, Getränkeflasche, EU:T:2013:201</p>
	<p>An image depicting certain stones is embossed on the central part of the bottle.</p> <p>The Court confirmed the BoA decision when it considered that the applicant had failed to prove that European consumers have sufficient information and knowledge to recognise that the embossing on the central part of the bottle at issue depicts the twelve-angle stones used in Inca constructions. Without that proof, European consumers will merely perceive the embossing as such without being aware of its significance, from which it follows that they will simply perceive it as a mere decoration without any distinctive character, because it is not particularly original or striking; therefore, it will not serve to differentiate the bottle in question from other bottles widely used in the packaging of beers (para. 25 et seq.).</p>	<p>12/07/2012, <a href="#">T-323/11</a>, Botella, EU:T:2012:376</p>

10.3.1.1.3 Position

The position of an element will affect its capacity to be identified as distinctive or not, and ultimately convey a distinctive character to the sign.

In general, distinctive elements will render a sign distinctive as a whole, irrespective of their position on the good and the usual presentation of the product on the market, as long as they can be identified as distinctive in the representation of the trade mark application.



**Distinctive examples**

Sign	Comments	Example
 <p>Class 32 Bottled drinking water</p>	<p>The verbal and figurative elements can be identified as distinctive in all of the examples, regardless of their position and thus render each sign distinctive as a whole.</p> <p>Although signs of origin are not commonly placed in the bottom part of a bottle, as shown in the last example, this possibility cannot be excluded.</p>	<p>CP9 examples</p>
 <p>Class 32 Bottled drinking water</p>		
 <p>Class 25 Shoes</p>	<p>Badges of origin can be commonly found on the insole of shoes. In this case, the distinctive element has been placed in an expected position, and it can clearly be identified as distinctive in the representation, therefore, it is able to render the sign distinctive as a whole.</p>	<p>CP9 example</p>

**Non-Distinctive examples**

Sign	Comments	Example
 <p data-bbox="236 1122 392 1149">Class 33 Wine</p>	<p data-bbox="616 293 978 517">The label containing the descriptive verbal element, placed in a typical position for this type of packaging of goods, does not render the sign distinctive as a whole.</p>	<p data-bbox="997 707 1142 734">CP9 example</p>

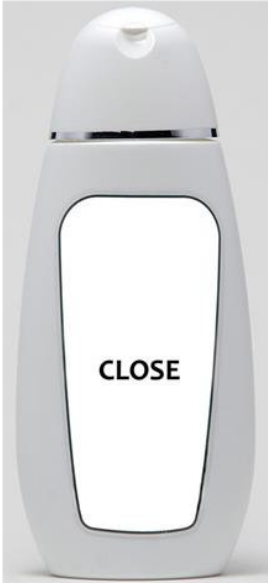
In some situations, elements may be perceived differently by the consumer because of their position on the goods, and thus change the finding of distinctiveness.

Distinctive Sign	Non-distinctive Sign	Comments	Example
 <p>Class 3 Cosmetics</p>	 <p>Class 3 Cosmetics</p>	<p>The verbal element 'CLOSE' bears no relation to the goods in Class 3.</p> <p>When placed centrally, the verbal element is perceived as distinctive, as it does not provide a descriptive indication of the good. Therefore, the sign as a whole is distinctive.</p> <p>However, when placed at the top of the product, next to the lid, it will be perceived as a descriptive indication of the opening/closing function of the lid.</p>	CP9 example

### 10.3.1.2 Colours

The situations in which colours cannot provide distinctiveness to the goods can be the following:

- in many instances, a colour would merely be a decorative element of the goods or comply with the consumer's request (e.g. colours of cars or T-shirts), irrespective of the number of colours concerned;
- a colour can be the nature of the goods (e.g. for tints);
- a colour can be technically functional (e.g. the colour red for fire extinguishers, various colours used for electric cables);
- a colour may also be usual (e.g. again, red for fire extinguishers);
- a colour may indicate a particular characteristic of the goods, such as a flavour (yellow for lemon flavour, pink for strawberry flavour). See judgment of 03/05/2017, [T-36/16](#), GREEN STRIPES ON A PIN (col.), EU:T:2017:295, § 43 to 47, in which the Court stated that the colour green, perceived as the colour of nature, would lead the relevant public to understand it as referring to the ecological nature of the goods at issue (wind energy converters).

A colour is not normally inherently capable of distinguishing the goods of a particular undertaking (06/05/2003, [C-104/01](#), Libertel, EU:C:2003:244, § 65). Therefore, a single colour will in principle not be distinctive for any goods and services except under

exceptional circumstances. In all cases, the examination will require a case-by-case analysis.

In principle, the mere fact of adding a single colour to the shape of a good in the absence of any other distinctive verbal or figurative distinctive element would not render the sign inherently distinctive.

**Non-distinctive examples**

Sign	Comments	Example
 <p data-bbox="236 860 464 887">Class 9 Memory card</p>	<p data-bbox="616 573 978 801">Consumers will not perceive the addition of a single yellow colour to the shape as an indication of origin. Use of colour on this type of goods is common on the market.</p>	<p data-bbox="997 719 1142 745">CP9 example</p>

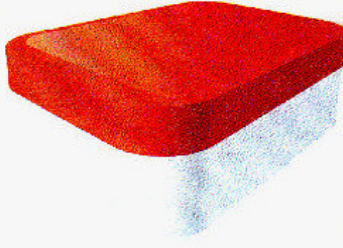
Sign	Comments	Case No
	<p>This representation of a tablet for <i>washing or dishwashing preparations in tablet form</i> was refused. The shape, namely a rectangular tablet, is a basic shape and an obvious one for a product intended for use in washing machines or dishwashers. The slightly rounded corners of the tablet and the colour chosen are not of a kind to attract the consumer's attention, so the overall impression will not indicate commercial origin (19/09/2001, <a href="#">T-30/00</a>, red-white squared washing tablet (fig.), EU:T:2001:223, § 43-44, 53). The same approach has been confirmed by several judgments, including that of 04/10/2007, <a href="#">C-144/06 P</a>, <i>Tabs</i> (3D), EU:C:2007:577.</p>	<p>19/09/2001, <a href="#">T-30/00</a>, red-white squared washing tablet (fig.), EU:T:2001:223</p>

However, it cannot be excluded that a particular arrangement of colours which is uncommon for the goods and creates an overall memorable impression can render the sign as a whole distinctive.

### **Distinctive example**



Sign	Comments	Example
 <p data-bbox="236 842 459 869">Class 7 Wind turbine</p>	<p data-bbox="614 293 976 600">This particular colour arrangement applied to the wind turbine is unusual in the market and simple enough to create a memorable overall impression for the specialised consumer to recall as a means of identification.</p>	<p data-bbox="995 566 1142 593">CP9 example</p>

**Non-distinctive example**

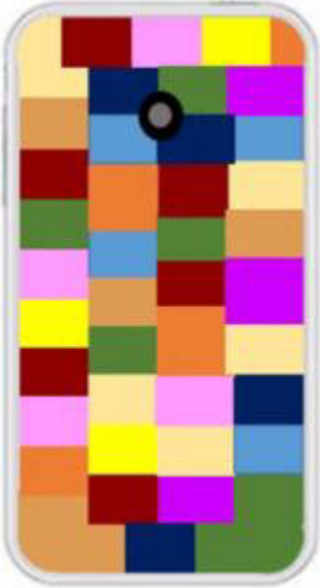
Sign	Comments	Example
 <p data-bbox="236 1720 539 1747">Class 9 Mobile phone cases</p>	<p data-bbox="614 1104 976 1411">For mobile phone cases, use of colour combinations is common in the market. Therefore, the consumer will not perceive this colour combination as an indication of origin, but as mere decoration for these goods. The sign is not distinctive as a whole.</p>	<p data-bbox="995 1413 1142 1440">CP9 example</p>

10.3.1.3 Combinations of factors and elements

There are situations where a shape mark contains more than one of the elements reviewed above. Moreover, there may be cases where more than one of the

abovementioned factors are relevant to determining the impact of the elements on the distinctiveness of the sign.

In all situations, the distinctiveness of the sign will depend on the overall impression produced by the combination of those factors and elements.

10.3.1.3.1 Combination of factors

When several factors (such as size, position or contrast) negatively affect the element from being identified as distinctive, this will lead to a non-distinctive overall impression of the sign.

**Non-distinctive examples**

Sign	Comments	Example
 <p data-bbox="236 1899 392 1928">Class 33 Wine</p>	<p data-bbox="614 779 979 1249">The size, position and lack of contrasting colours of the verbal element result in a non-distinctive overall impression. The element cannot be identified as distinctive on the good without a very close inspection, as it has been placed in a less visible place on the bottle, using a very small size and a poor use of contrast. Therefore, it cannot render the mark distinctive as a whole.</p>	<p data-bbox="995 1339 1142 1368">CP9 example</p>

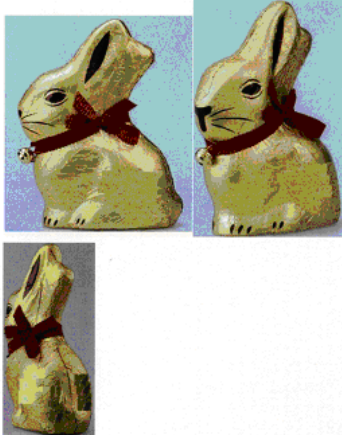
Sign	Reasoning	Case No
	<p>The shape applied for was refused as it was considered that bunny-shaped chocolate with gold wrapping is a common phenomenon on the market corresponding to the industry concerned. An analysis of the individual elements, that is, the shape of a rabbit, the gold foil wrapping and the red ribbon with a bell, were held both individually and cumulatively devoid of distinctive character (paras 44-47).</p>	<p>24/05/2012, <a href="#">C-98/11 P</a>, Hase, EU:C:2012:307</p>

**Distinctive example**

Sign	Comments	Example
 <p>Class 9 Glasses</p>	<p>The size of the (verbal) element and its contrast with the goods enable it to be identified as distinctive: together, they give a distinctive overall impression.</p>	<p>CP9 example</p>

**10.3.1.3.2 Combination of non-distinctive elements**

In general, combining a non-distinctive shape with verbal and/or figurative elements, which are considered individually devoid of distinctive character, does not result in a distinctive sign.

**Non-distinctive example**

Sign	Comments	Example
 <p data-bbox="236 1413 392 1442">Class 33 Wine</p>	<p data-bbox="614 293 979 763">The verbal and figurative elements are non-distinctive as they provide descriptive information of the goods in question. Although placed in a central position on the shape, and despite their large size and sufficient contrast, they are unable to render the sign distinctive as a whole, as the consumer will not perceive the combination as a source of origin.</p>	<p data-bbox="995 853 1139 882">CP9 example</p>

Nevertheless, combining a non-distinctive shape with elements which, when considered individually are devoid of distinctive character, could be perceived as a badge of origin due to the perception of the relevant consumer and the composition of the sign, when considered as a whole.

**Distinctive example**

Sign	Comments	Example
 <p data-bbox="236 607 446 636">Class 30 Chocolate</p>	<p data-bbox="614 286 978 562">The descriptive elements have been arranged in a way that they create the shape of a sun or a flower; a combination which can be perceived as a badge of origin and which therefore renders the sign distinctive as a whole.</p>	<p data-bbox="994 450 1142 479">CP9 example</p>

**10.3.1.3.3 Combination of distinctive and non-distinctive verbal/figurative elements and colours**

In general, combining a distinctive element together with other non-distinctive elements on a non-distinctive shape may render the mark distinctive as a whole, as long as the distinctive element can be clearly identified among all the other elements.

**Distinctive example**

Sign	Comments	Example
 <p data-bbox="236 1361 446 1391">Class 30 Chocolate</p>	<p data-bbox="614 1164 978 1518">Despite the combination of many non-distinctive elements, the verbal element 'ECS' can be identified as distinctive in the representation due to its size, position and contrast with respect to the good, and therefore it is able to render the sign distinctive as a whole.</p>	<p data-bbox="994 1335 1142 1364">CP9 example</p>

However, if the distinctive element is not immediately perceived by the consumer due to the presence of non-distinctive elements, the combination may result in a non-distinctive sign.

**Non-distinctive example**

Sign	Comments	Example
 <p>Class 30 Chocolate</p>	<p>The verbal element ECS is lost within multiple non-distinctive elements. Due to its position, size and lack of contrast, it cannot be identified as distinctive without close inspection and therefore, cannot render the sign distinctive as a whole.</p>	<p>CP9 example</p>

### 10.3.2 Shape of the goods themselves or shapes related to the goods or services

#### 10.3.2.1 The specific case of toys, dolls and play figures

Applications for shape marks in respect of toys, dolls and play figures in Class 28, or for figurative marks consisting of a faithful representation of such goods, must be assessed in the **same way as for other shape marks**.

To be distinctive, the shape must depart significantly from the shape that is expected by the consumer. In other words, it must depart significantly from the norm or customs of the sector so that it enables a consumer to identify the goods just by their shape.

This may be complicated by the sheer volume and proliferation of toy animals, figures, dolls and assorted characters in this market sector. Simply adding a **basic** set of **clothing or basic human characteristics** such as eyes or a mouth to a common plush toy such as a rabbit or a cat will generally not suffice. It is commonplace to present toy dolls and animals in clothing and to provide a separate range of clothing options, so that the user of such goods can change the appearance of the toy. It is also common to humanise the toys to make them more attractive. Within such a high-volume marketplace, the presentation of these goods in such a way will invariably leave the relevant consumer struggling, without prior exposure, to perceive a badge of origin in such marks.



The more basic the character, the more unusual the additional elements must be in order to create a whole that serves to ensure that the relevant public is able to distinguish the applicant's goods from similar goods provided by other undertakings. The final conclusion must be based on the **appearance of the sign as a whole**.



#### *Rejected toy shapes*

Sign	Reasoning	Case No

	<p>The parrot figure applied for, on its own, does not depart sufficiently from the usual form of parrot toys to be seen as a trade mark. Its coat colour resembles the green quite common among parrots. Its head is bigger than normal and it is standing on its hind legs but, in the Board's opinion, the majority of consumers would perceive the parrot shape as an ordinary parrot-shaped toy design, and a rather banal toy, but not as an indication of origin (para. 16).</p>	<p><a href="#">R 2131/2013-5</a></p>
---	---	--------------------------------------

*Accepted toy shapes*

Sign	Reasoning	Case No
	<p>Accepted for toys</p>	<p>EUTM No 15 240 534</p>
	<p>Accepted for toys</p>	<p>EUTM No 18 140 709</p>

	<p>Accepted (among other goods in class 28) for toys</p>	<p>EUTM No 18 007 266</p>
	<p>Accepted (among other goods in class 28) for toys</p>	<p>EUTM No 16 395 361</p>



### 10.3.2.2 Examples of shapes of the goods themselves or shapes related to the goods or services

The following is a list of examples of shapes of goods for which protection has been sought and an analysis of them (in relation with [Article 7\(1\)\(b\)](#) only).



#### *Rejected product shapes*

Sign	Reasoning	Case No
	<p>This shape was refused as it is merely a variant of a common shape of this type of product, i.e. <i>flashlights</i> (para. 31).</p>	<p>07/10/2004, <a href="#">C-136/02 P</a>, <i>Torches</i></p>



	<p>The Court of Justice confirmed the refusal of this three-dimensional sign as not being sufficiently different from the shapes and colours of those commonly used in the sweet and chocolate sectors. The combination with figurative elements will not lead to the application of the criteria for two-dimensional marks.</p>	<p>06/09/2012, <a href="#">C-96/11</a> P, Milchmäuse, EU:C:2012:537</p>
	<p>This shape mark consisting of a handle, applied to goods in Class 8 (<i>hand-operated implements used in agriculture, horticulture and forestry, including secateurs, pruning shears, hedge clippers, shearers (hand instruments)</i>) was refused.</p>	<p>16/09/2009, <a href="#">T-391/07</a>, Teil des Handgriffes, EU:T:2009:336</p>
	<p>The General Court confirmed the case-law on non-distinctiveness of shape marks in the form of a product or its packaging. Even if the oval shape in the EUTM application has a complex hollow on its surface, this cannot be considered as significantly different from the shapes of confectionery available on the market.</p>	<p>12/12/2013, <a href="#">T-156/12</a>, Oval, EU:T:2013:642</p>

*Accepted product shapes*

Sign	Reasoning	EUTM No
	<p>Accepted for <i>ice creams</i></p>	<p>EUTM No 10 350 593 Confirmed by the Boards of Appeal in <a href="#">R 590/2015-4</a></p>
	<p>Accepted for <i>pumps, compressors</i></p>	<p>EUTM No 5 242 433</p>
	<p>Accepted in Class 9, <i>protective covers for mobile phones</i></p>	<p>EUTM No 12 269 511</p>

Analogous criteria, *mutatis mutandis*, apply to shapes related to services, for example the device of a washing machine for laundry services.

Sign	Reasoning	Case No
------	-----------	---------

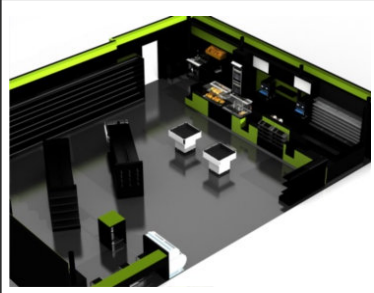
	<p>Class 35 – Retail Services for various goods and services.</p> <p>The case-law on marks consisting of the shape of the goods applies also with respect to services. The ‘get-up’ or appearance of services consists, in particular, of the environment in which they are offered and/or the means used in order to provide the services to the relevant consumer. Such ‘get-up’ is only distinctive where it significantly departs from the norms of the relevant sector. The salesroom depicted in the application will be perceived as having the merely functional purpose of enabling consumers to purchase conveniently the goods and services offered for inspection and sale.</p> <p>The first instance decision regarding the mark’s lack of distinctive character was confirmed by the Board.</p>	<p>R 2224/2015-1</p>
---	---	----------------------



### 10.3.3 Shape of the packaging or containers

The shape applied for must be materially different from a combination of basic or common elements and must be striking. In the area of containers, regard must also be had to any functional character of a given element. As, in the field of containers and bottles, usage in trade might be different for different types of goods, it is recommended to make a search as to which shapes are on the market by choosing a sufficiently broad category of the goods concerned (i.e. in order to assess the distinctiveness of a milk container, a search must be carried out in relation to containers for beverages in general; see, in that regard, the Opinion of the Advocate General of 14/07/2005, [C-173/04 P](#), Standbeutel, EU:C:2005:474).

Examples of marks for which protection was sought for the shape of the packaging

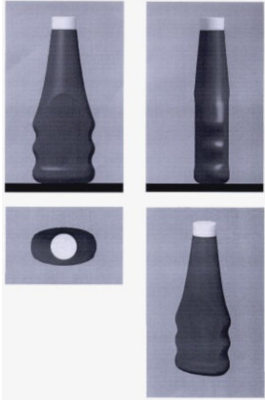

*Rejected trade marks*

Sign	Reasoning	Case No
	<p>The mark, the representation of a twisted wrapper serving as packaging for sweets (and thus not the product itself), was refused registration as it is a 'normal and traditional shape for a sweet wrapper and ... a large number of sweets so wrapped could be found on the market' (para. 56). The same applies in respect of the colour of the wrapper in question, namely 'light brown (caramel)'. This colour is not unusual in itself, and neither is it rare to see it used for sweet wrappers (para. 56). Therefore, the average consumer will not perceive this packaging in and of itself as an indicator of origin, but merely as a sweet wrapper.</p>	<p>10/11/2004, <a href="#">T-402/02</a>, Bonbonverpackung, EU:T:2004:330</p>

Sign	Reasoning	Case No
	<p>The refusal of the shape applied for was confirmed by the General Court. The elongated neck and the flattened body do not depart from the usual shape of a bottle containing the goods for which protection was sought, namely food products including <i>juices, condiments and dairy products</i>. In addition, neither the length of the neck, its diameter nor the proportion between the width and thickness of the bottle is in any way individual (para. 50). Furthermore, even if the ridges around the sides of the bottle could be considered distinctive, these alone are insufficient to affect the overall impression given by the shape applied for to such an extent that it departs significantly from the norm or customs of the sector (para. 53).</p>	<p>15/03/2006, <a href="#">T-129/04</a>, Plastikflaschenform, EU:T:2006:84</p>
	<p>The shape does not depart significantly from the norms and customs of the sector, 'where what is involved is the packaging of a liquid product and the sign consists of the appearance of the product itself'.</p>	<p>07/05/2015, <a href="#">C-445/13 P</a>, Bottle, EU:C:2015:303, confirming 28/05/2013, <a href="#">T-178/11</a>, Bottle, EU:T:2013:272</p>

*Accepted trade marks*

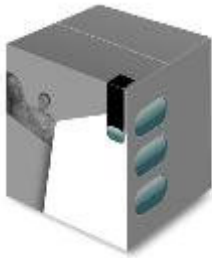
Sign	Reasoning	Case No
------	-----------	---------

	Accepted for goods in Classes 4 and 11	EUTM No 12 491 858
	The Board of Appeal annulled the decision refusing the registration of the shape mark for <i>chewing gums and other confectionery</i> . The Board of Appeal considered that the shape is not common in the market sector in question.	R 832/2012-2

## 11 Position Marks

According to [Article 3\(3\)\(d\) EUTMIR](#), position marks are trade marks consisting of the specific way in which the mark is placed on or affixed to the product.

Applications for position marks effectively seek to extend protection to the specific way in which elements (figurative, colour, etc.) are placed on or affixed to the product.



The factors to be taken into account when examining shape marks are also relevant for position marks. In particular, the examiner must consider whether the relevant consumer will be able to identify a sign that is different from the normal appearance of the products themselves. A further relevant consideration in dealing with position marks is whether the positioning of the mark upon the goods is likely to be understood as having a trade mark context.

Note that even where it is accepted that the relevant public may be attentive to the different aesthetic details of a product, this does not automatically imply that they will perceive it as a trade mark. In certain contexts, and given the norms and customs of particular trades, a position mark may appeal to the eye as an independent feature being distinguishable from the product itself and thus communicating a trade mark message.

### Examples

The following are examples of the assessment of position marks.

*Rejected position marks*

Sign	Reasoning	Case No
	<p>In this case, the General Court upheld an objection under <a href="#">Article 7(1)(b) EUTMR</a>. The mark description specified that 'The mark consists of the position of the circular and rectangular fields on a watch face'. The Court considered that the mark was not independent or distinguishable from the form or design of the product itself and that the positioned elements were not substantially different from other designs on the market.</p>	<p>14/09/2009, <a href="#">T-152/07</a>, Uhr, EU:T:2009:324</p>
	<p>In this case involving hosiery consisting of an orange strip covering the toe area, the General Court considered that there was no evidence to suggest that the colouring of this part of the product would normally be perceived as having trade mark character. On the contrary, it was considered that this feature would be likely to be perceived as a decorative feature falling within the norms and customs of the market sector. The <a href="#">Article 7(1)(b) EUTMR</a> objection was therefore maintained.</p>	<p>15/06/2010, <a href="#">T-547/08</a>, Strumpf, EU:T:2010:235</p>

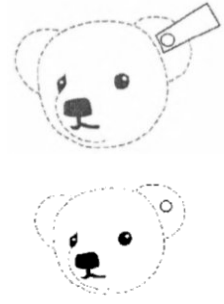
Sign	Reasoning	Case No
	Buttons are common decorative elements of soft toys. A button is a simple geometrical form that does not depart from the norm or customs of the sector. It is not uncommon to attach badges, rings, ribbons, loops and embroidery to the ears of a soft toy. The relevant public will therefore perceive the two signs applied for as ornamental elements but not as an indication of commercial origin.	16/01/2014, <a href="#">T-433/12</a> , Knopf im Stofftierohr, EU:T:2014:8 & 16/01/2014, <a href="#">T-434/12</a> , Fähnchen im Stofftierohr, EU:T:2014:6

*Accepted position mark*

Sign	Description	EUTM No
	Class 25 Description: the trade mark is a position mark. It consists of a figurative element placed on the outer surface of the upper part of a shoe, extending lengthwise from the centre of the cuff of the shoe down to the sole. The dotted line shows the position of the trade mark on the shoe, and does not form part of the trade mark.	EUTM No 13 755 244

**12 Pattern Marks**

[Article 3\(3\)\(e\) EUTMIR](#) defines pattern marks as trade marks consisting exclusively of a set of elements that are repeated regularly.

Pattern marks may cover any kind of goods and services. However, in practice they are more commonly filed in relation to goods such as paper, fabrics, clothing articles, leather goods, jewellery, wallpaper, furniture, tiles, tyres, building products, etc., that is to say, goods that normally feature designs. In these cases, the pattern is nothing else



than the outward appearance of the goods. Although patterns may be represented in the form of square/rectangular labels, they should nonetheless be assessed as if they covered the entire surface of the goods for which protection is sought.

It must also be taken into account that when a pattern mark claims protection for goods such as beverages or fluid substances in general, that is to say, goods that are normally distributed and sold in containers, the assessment of the design should be made as if it covered the outward surface of the container/packaging itself.

It follows from the above that, as a rule, in the assessment of the distinctive character of patterns, the examiner should use the same criteria that are applicable to shape marks that consist of the appearance of the product itself (19/09/2012, [T-329/10](#), Stoffmuster, EU:T:2012:439).

With regard to services, examiners should bear in mind that pattern marks will be used in practice on letterheads and correspondence, invoices, internet websites, advertisements, shop signs, etc.

In principle, if a pattern is commonplace, traditional and/or typical, it is devoid of distinctive character. In addition, patterns that consist of basic/simple designs usually lack distinctiveness. The reason for the refusal lies in the fact that such patterns do not convey any 'message' that could make the sign easily memorable for consumers. Paradoxically, the same applies to patterns composed of extraordinarily complex designs. In these cases the complexity of the overall design will not allow the design's individual details to be committed to memory (09/10/2002, [T-36/01](#), Glass Pattern, EU:T:2002:245, § 28). Indeed, in many cases the targeted public would perceive patterns as merely decorative elements.

In this regard, it must be taken into account that the average consumer tends not to look at things analytically. A trade mark must therefore enable average consumers of the goods/services in question, who are reasonably well informed and reasonably observant and circumspect, to distinguish the product concerned from those of other undertakings without conducting an analytical or comparative examination and without paying particular attention (12/02/2004, [C-218/01](#), Perwoll, EU:C:2004:88, § 53; 12/01/2006, [C-173/04 P](#), Standbeutel, EU:C:2006:20, § 29).



The fact that the pattern may also have other functions and/or effects is an additional argument for concluding that it lacks distinctive character. By contrast, if a pattern is fanciful, unusual and/or arbitrary, departs from the norm or customs of the sector or is, more generally, capable of being easily memorised by the targeted consumers, it usually deserves protection as an EUTM.



As seen above, the distinctive character of pattern marks must usually be assessed with regard to goods. Nevertheless, a pattern mark that has been considered devoid of distinctive character for the goods it covers must also be regarded as lacking distinctiveness for services that are closely connected to those goods. For example, a stitching pattern that is devoid of distinctive character for clothing articles and leather goods must be regarded as lacking distinctiveness also for retail services concerning those goods (see, by analogy, decision of 29/07/2010, [R 868/2009-4](#), DEVICE OF A

POCKET (fig.)). The same considerations would apply to a fabric pattern with regard to services such as *manufacture of fabrics*.

### Examples of pattern marks

#### *Rejected pattern marks*

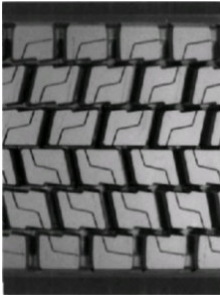
Sign	Reasoning	Case No
 <p data-bbox="233 972 600 1079">EUTM No 8 423 841, filed as a figurative mark in Classes 18, 24 and 25</p>	<p data-bbox="612 492 979 1258">The criteria for shape marks consisting of the appearance of the product itself are also applicable to figurative marks consisting of the appearance of the product itself. In general, a mark consisting of a decorative pattern that is simple and commonplace is considered devoid of any element that could attract the consumers' attention, and insufficient to indicate the source or origin of goods or services. The above pattern mark was a textile pattern and therefore considered to comprise the appearance of the goods itself, as the mark was applied for in Classes 18, 24 and 25.</p>	<p data-bbox="992 819 1126 927">19/09/2012, Stoffmuster, § 47-48</p> <p data-bbox="1190 819 1359 887"><a href="#">T-329/10</a>, EU:T:2012:439,</p>
 <p data-bbox="233 1612 600 1720">EUTM No 8 423 501, filed as a figurative mark in Classes 18, 24 and 25</p>	<p data-bbox="612 1451 979 1559">In this case, similarly to the previous case, the General Court confirmed the refusal of the mark.</p>	<p data-bbox="992 1469 1126 1536">19/09/2012, Stoffmuster</p> <p data-bbox="1254 1469 1359 1496"><a href="#">T-329/10</a>,</p>

Sign	Reasoning	Case No
 <p data-bbox="236 719 600 786">EUTM No 5 066 535 filed as a figurative mark in Class 12 (<i>tyres</i>)</p>	<p data-bbox="616 293 976 887">Where the mark consists of a stylised representation of the goods or services, the relevant consumer will see prima facie the mere representation of the entire product or a specific part thereof. In this case of an application for <i>tyres</i>, the relevant consumer would perceive the mark as merely a representation of the grooves of a tyre, and not an indication of source of origin. The pattern is banal and the mark cannot fulfil its function as an indicator of origin.</p>	<p data-bbox="995 555 1356 622">Examiner's decision without BoA case</p>
 <p data-bbox="236 1229 600 1375">EUTM No 9 526 261, filed as a figurative mark (Series of stylised V letters), claiming goods in Classes 16, 18 and 25</p>	<p data-bbox="616 925 976 1438">The mark was rejected for Classes 18 and 25. It was accepted for Class 16. Though the sign was described as a 'series of stylised V letters', the sign would most probably be perceived by the relevant public either as a series of zigzag stitching or as a set of rhomboidal geometric figures. In any case, the pattern is quite simple and banal and thus devoid of any distinctive character.</p>	<p data-bbox="995 1149 1356 1216">Examiner's decision without BoA case</p>

Sign	Reasoning	Case No
<div data-bbox="308 557 525 772" data-label="Image"> </div> <p data-bbox="233 790 598 898">EUTM No 3 183 068, filed as a figurative mark, for goods in Classes 19 and 21</p>	<p data-bbox="614 288 979 1176">The mark, which was to be applied to glass surfaces, was refused under <a href="#">Article 7(1)(b) EUTMR</a>. It was reasoned that the relevant consumer is not used to perceiving designs applied to glass surfaces as an indication of origin and that the design is recognisable as a functional component to make the glass opaque. Furthermore, the complexity and fancifulness of the pattern are insufficient to establish distinctiveness, attributable to the ornamental and decorative nature of the design's finish, and do not allow the design's individual details to be committed to memory or to be apprehended without the product's inherent qualities being perceived simultaneously.</p>	<p data-bbox="995 696 1359 763">09/10/2002, <a href="#">T-36/01</a>, Glass Pattern, § 26-28</p>

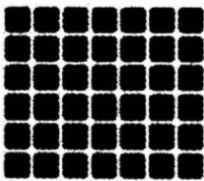
Sign	Reasoning	Case No
 <p>EUTM No 10 144 848, filed as a figurative mark for goods in Classes 3, 5, 6, 10, 11, 12, 16, 18, 20 and 21</p>	<p>The mark was refused as it is composed of very simple elements and is a basic and banal sign as a whole. For the claimed goods, such as <i>cleaning cloths</i> and <i>antiseptic wipes</i>, the sign applied for can represent their appearance in the sense that the fabric used may have this structure. The sign is merely a repetition of identical squares that does not display any element or noticeable variation, in particular in terms of fancifulness or as regards the way in which its components are combined, that would distinguish it from the usual representation of another regular pattern consisting of a different number of squares. Neither the shape of each individual square nor the way they are combined is an immediately noticeable feature that could catch the average consumer's attention and cause the consumer to perceive the sign as a distinctive one.</p>	<p>14/11/2012, <a href="#">R 2600/2011-1</a>, DEVICE OF A BLACK AND WHITE PATTERN (fig.)</p>

*Accepted pattern marks*

Sign	Reasoning	EUTM No
	<p>Classes 16, 18, 25</p>	<p>EUTM No 15 602</p>

Sign	Reasoning	EUTM No
	Classes 18, 20, 21, 24, 25, 27	EUTM No 3 191 301

## 13 Colour Marks

This paragraph is concerned with single colours or combinations of colours as such ('colour marks' within the meaning of [Article 3\(3\)\(f\) EUTMIR](#)).

Where colours or colour combinations as such are applied for, the appropriate examination standard is whether they are distinctive either if applied to the goods or their packaging, or if used in the context of delivery of services. It is a sufficient ground for a mark to be refused if the mark is not distinctive in either of these situations. For colour combinations, examination of distinctiveness should be based on the assumption that the colour combination appears on the goods or their packaging, in a way that accords with the representation, or in advertisements or promotional material for the services.

### 13.1 Single Colours

As regards the registration as trade marks of colours per se, the fact that the number of colours actually available is limited means that a small number of trade mark registrations for certain services or goods could exhaust the entire range of colours available. Such an extensive monopoly would be incompatible with a system of undistorted competition, in particular because it could have the effect of creating an unjustified competitive advantage for a single trader. Nor would it be conducive to economic development or the fostering of the spirit of enterprise for established traders to be able to register the entire range of colours that is in fact available for their own benefit, to the detriment of new traders (06/05/2003, [C-104/01](#), Libertel, EU:C:2003:244).

As has been confirmed by the Court of Justice, consumers are not in the habit of making assumptions about the origin of goods based on their colour or the colour of their packaging, in the absence of any graphic or word element, because as a rule a colour per se is not used as a means of identification in current commercial practice (06/05/2003, [C-104/01](#), Libertel, EU:C:2003:244). A colour is not normally inherently capable of distinguishing the goods of a particular undertaking (para. 65). Therefore, single colours are not distinctive for any goods and services except under exceptional circumstances.

Such exceptional circumstances require the applicant to demonstrate that the mark is unusual or striking in relation to these specific goods or services. These cases will be very rare, for example in the case of the colour black for milk. It is not necessary for a refusal that one of the factors listed in [paragraph 13.2](#) below is present, but if this is the case, it should be used as a further argument in support of the refusal. Where the single colour is found to be commonly used in the relevant sector(s) and/or to serve a decorative or functional purpose, the colour must be refused. The public interest is, according to the Court, an obstacle to the monopolisation of a single colour, irrespective of whether the relevant field of interest belongs to a very specific market segment (13/09/2010, [T-97/08](#), Colour (shade of orange) II, EU:T:2010:396, § 44-47).

Sign	Goods and services	Reasoning	Case No
------	--------------------	-----------	---------

	<p>Classes 5, 10</p>	<p>Barring specific cases where laws or regulations mandate the use of certain colours, manufacturers sell inhalers in a variety of colours (para. 44).</p> <p>Per the <i>Good practice guide on risk minimisation and prevention of medication errors</i> by the European Medicines Agency (EMA), colour coding is not usually recommended in the medicinal products market given the limited range of available colours and the lack of common understanding of colour coding conventions (para. 45).</p> <p>However, as the Board of Appeal rightly noted in paragraph 33 of the contested decision, the EMA's good practice guide does recommend considering the choice of colour when designing the product, to ensure there is no risk of confusion with other established products where informally agreed colour conventions exist. The example given in that regard in the guide is precisely that of inhalers for respiratory ailments (para. 46).</p> <p>It follows then that, on the relevant market, colours can be used to convey information to</p>	<p>09/09/2020, <a href="#">T-187/19</a></p>
<p>FINAL</p>	<p>VERSION 1.0</p>	<p>the public on the characteristics of the goods. The applicant's</p>	<p>Page 449</p> <p>31/03/2023</p>



## 13.2 Colour combinations

In the case of a colour combination, a refusal can only be based on specific facts or arguments, and where such specific arguments for refusal are not established, the mark must be accepted. If one of the two colours is either the commonplace colour for the product or the natural colour of the product, that is to say, a colour is added to the usual or natural colour of the product, an objection applies in the same way as if there were only one colour. Example: grey is the usual colour for the grip of gardening tools, and white is the natural colour of washing tablets. Therefore, a washing tablet that is white with another layer in red is in fact to be judged as a case that involves the addition of a colour.

The situations in which a combination of two colours should nevertheless be refused include the following.

- In many instances, a colour would merely be a decorative element of the goods or comply with the consumer's request (e.g. colours of cars or T-shirts), irrespective of the number of colours concerned.
- A colour can be the nature of the goods (e.g. for tints).
- A colour can be technically functional (e.g. colour red for fire extinguishers, various colours used for electric cables).
- A colour may also be usual (e.g. again, red for fire extinguishers, yellow for postal services in many countries).
- A colour may indicate a particular characteristic of the goods, such as a flavour (yellow for lemon flavour, pink for strawberry flavour). See the GREEN STRIPES ON A PIN (col.) judgment (03/05/2017, [T-36/16](#) , GREEN STRIPES ON A PIN (col.), EU:T:2017:295, § 43-47), in which the Court stated that the colour green, perceived as the colour of nature, would lead the relevant public to understand it as referring to the ecological nature of the goods at issue ( *wind energy converters* ).
- A colour combination should also be refused if the existence of the colour combination can already be found on the market, in particular if used by different competitors (e.g. the Office proved that the colour combination red and yellow is used by various enterprises on beer and soft drink cans).

In all these cases the trade mark should be objected to but with careful analysis of the goods and services concerned and the situation on the market.

The criteria to assess the distinctiveness of colour marks designating services should not be different from those applicable to colour marks designating goods (as reiterated by the General Court in its Grau/Rot judgment (12/11/2010, [T-404/09](#) , Grau/Rot, EU:T:2010:466)). In this case, the colour combination applied for was considered not to differ for the relevant consumer in a perceptible manner from the colours generally used for the services concerned. The General Court concluded that the colour combination applied for was very close to the combination 'white/red' used on the railway crossing gates and traffic signs associated with train traffic and that the sign, as a whole, would be recognised by the relevant public as a functional or decorative element and not as an indication of the commercial origin of the services.

Sign	Goods and services	Reasoning	Case No
	Classes 9, 12, 14, 16, 18, 24, 25, 28	<p>The three colours making up the mark are clearly separated. They are relatively easy to remember and the three sections are equally proportioned. None of the colours represents a typical natural colour of the goods; the examiner did not argue otherwise for any category of goods from the extensive list of refused goods (para. 15).</p> <p>The mark is not too complex to be memorised. It is not a sequence of irregularly arranged coloured fields or boxes, or a rainbow-like sequence representing the full colour spectrum, or any other type of colour pattern that would be too complex for an average consumer to easily memorise (12/11/2008, <a href="#">T-400/07</a> , Farben in Quadraten, EU:T:2008:492, § 47; 04/07/2014, <a href="#">R 365/2014-4</a> , Vielfarbiger Streifen, § 10; 19/02/2014, <a href="#">R 1317/2013-4</a> . Farbverlauf Regenbogen, § 10) (para. 18).</p>	11/07/2019, <a href="#">R 0381/2019-4</a>

For the names of colours see the Guidelines, [Part B, Examination, Section 4, Absolute Grounds for Refusal, Chapter 4, Descriptive Trade Marks \(Article 7\(1\)\(c\) EUTMR\)](#) .

## 14 Sound Marks

The definition of sound marks is restricted to only those that consist exclusively of a sound or a combination of sounds ( [Article 3\(3\)\(g\) EUTMIR](#) ). Trade marks combining sounds with other elements, namely movement, do not qualify as sound marks, but are considered multimedia marks.

The acceptability of a sound mark must, like words or other types of trade marks, depend on whether the sound is distinctive per se , that is, whether the average consumer will perceive the sound as a memorable one that serves to indicate that the goods or services are exclusively associated with one undertaking. A sound must have ‘a certain resonance’ (13/09/2016, [T-408/15](#) , SON D’UN JINGLE SONORE PLIM PLIM (sound mark), EU:T:2016:468, § 45) enabling the target consumer to perceive and consider it a mark. Such resonance is lacking where the sound is perceived as a functional element of the goods and services for which protection is sought or as an indicator without any intrinsic characteristic of its own (§ 24), for example, due to its excessive simplicity or banality (07/07/2021, [T-668/19](#) , KLANG EINES GERÄUSCHES, WELCHES MAN BEIM ÖFFNEN EINER GETRÄNKEDOSE HÖRT, EU:T:2021:420, § 24, 25, 27, 41).

In applying the criteria for assessing the distinctive character of a trade mark, the examiner must take into account that the relevant public’s perception may be influenced by the nature of the sign for which registration is sought. In effect, the relevant public’s perception is not necessarily the same in the case of a sign consisting of a sound per se as it is in the case of a word or figurative mark consisting of a sign that bears no relation to the appearance of the goods it denotes.

Consumers are not in the habit of making assumptions about the origin of goods in the absence of any graphic or word element because, generally, a sound per se is not commonly used in any field of commercial practice as a means of identification. However, marketing habits in an economic sector are not fixed and can evolve in a very dynamic way, including as regards the use of sound marks. For example, it is well known that operators in the food market, characterised by strong competition, have to package their goods for marketing and are highly motivated to ensure that their goods can be identified in order to attract the consumers’ attention, including through sound marks and marketing and advertising efforts. (07/07/2021, [T-668/19](#) , KLANG EINES GERÄUSCHES, WELCHES MAN BEIM ÖFFNEN EINER GETRÄNKEDOSE HÖRT, EU:T:2021:420, § 26).

The kinds of sound marks that are **unlikely** to be accepted without evidence of factual distinctiveness include:



1. very simple pieces of music consisting of only one or two notes (see examples below);



2. sounds that are in the common domain (e.g. La Marseillaise, Für Elise);
3. sounds that are too long to be considered as an indication of origin;
4. sounds typically linked to specific goods and services (see examples below).

Where the sign applied for consists of a non-distinctive sound but includes **other distinctive elements**, such as words or lyrics, it will be considered as a whole.

In the framework of the European Union Intellectual Property Network, the trade mark offices of the European Union have agreed on a Common Communication on New Types of Marks: Examination of Formal Requirements and Grounds for Refusal ([CP11](#)). They agreed on examples of sound marks that are considered to be distinctive/non-distinctive in relation to the corresponding goods and/or services. Some examples are reproduced below, further examples can be found in the [CP11](#).

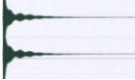
#### Examples of non-acceptable trade marks

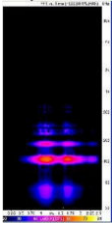
Sign	Goods and services	Reasoning	Case No
 [Two musical notes, F and C]	35, 36, 38, 39, 41, 42	A two note 'tune' has no impact on the consumer and will only be perceived by the consumer as a very banal sound, such as the 'ding-dong' of a doorbell.	EUTM No 4 010 336
 [Two extremely short blips]	9, 38	Machine-generated blip that is commonly emitted by computers and other electronic devices.	EUTM No 9 199 167
 [Ping sound, resembling a warning signal]	9, 16, 28	Sound constitutes a warning signal and a direct characteristic of the goods for which protection is sought.	<a href="#">R 2444/2013-1</a>

Sign	Goods and services	Reasoning	Case No
 <p>[Machine-generated synthesised sound]</p>	<p>9, 12, 35</p>	<p>Sound typically linked to the goods and services for which protection is sought.</p>	<p><a href="#">R 1338/2014-4</a></p>
 <p>[The first 13 notes of 'La Marseillaise']</p>	<p>Any</p>	<p>A national anthem is in the public domain. This necessarily implies that it is a non-distinctive sign as it will not be perceived as an indicator of commercial origin.</p>	<p>Invented example</p>

Sign	Goods and services	Reasoning	Case No
	9, 38 and 41	<p>Although – as regards certain goods or services – a sound may be commonly used to identify a good or service as coming from a particular undertaking, such sound cannot be perceived either (i) as a functional element or (ii) as an indicator without any inherent characteristics. In particular, a sound sign characterised by excessive simplicity will not be perceived as a trade mark.</p> <p>In the present case, the mark applied for is a very simple sound motif, that is to say, in essence, a banal and commonplace ringing sound that would generally go unnoticed and would not be remembered by the target consumer.</p>	13/09/2016, <a href="#">T-408/15</a> , SON D'UN JINGLE SONORE PLIM PLIM (sound mark), EU:T:2016:468
EUTM No <a href="#">17 622 663</a>	9, 16, 35, 41, 42	The sign claimed consists of a sequence of electronically generated (synthetic) sounds, which lasts only 2 to 3 seconds. The overall impression is that of a very short, dissonant electronic tone sequence.	<a href="#">R 2721/2019-4</a> , (SONIDO DE UNA CAJA CHINA CON UN AUMENTO DE LA DIAMICA EN LA PRIMERA NOTA)

Sign	Goods and services	Reasoning	Case No
(Sound of a door bell) <a href="#">Link</a>	9: <i>door bells</i>	The sound perceived in the mark can be easily connected to the goods for which protection is sought. Therefore, the mark would be considered non-distinctive.	CP11 example

Sign	Goods and services	Reasoning	Case No
<p>(Sound of an opening can)</p> <p><a href="#">Link</a></p>	<p>6, 29, 30, 32, 33</p>	<p>The relevant consumer perceives the <b>first element</b> of the mark – <b>the sound of opening a can</b> – as purely technical and functional. This is because it is intrinsic to a specific technical solution for handling and consuming the beverages applied for (§ 40). Its <b>second sound element</b> – <b>the sound of fizzing bubbles</b> – is perceived as referring to the drinks for which protection is sought (§ 42).</p> <p>Perceived in its entirety, the mark is not distinctive (§ 43, 48). This is so despite the silence of ten seconds between the two sound elements and the length (nine seconds) of the second sound element. Such nuances of the classic sounds made by drinks when their container is opened are perceived as <b>mere variants of the usual sounds</b> (§ 45).</p> <p>They are <b>not sufficiently resonant to distinguish them from comparable sounds</b> (§ 46).</p> <p>Just because the sound of fizzing bubbles is usually shorter and immediately follows the sound of opening a can</p>	<p>(07/07/2021, <a href="#">T-668/19</a> ,                  KLANG EINES GERÄUSCHES, WELCHES MAN BEIM ÖFFNEN EINER GETRÄNKEDOSE HÖRT, EU:T:2021:420)</p>
<p>FINAL</p>	<p>VERSIO</p>	<p><b>does not confer any significance on the sounds allowing the</b></p>	<p>Page 457</p> <p>31/03/2023</p>



*Examples of acceptable trade marks*

Sign	Goods and services	Reasoning	Case No
N/A (electronic file) [Short sequence of easily identifiable tones]	9, 35, 36, 37, 38, 39, 42, 43, 44, 45	The sign is short but it is not too simple and is capable of being memorised by the relevant consumer.	EUTM No <a href="#">17 396 102</a>
N/A (electronic file) [Human voice]	3, 9, 16, 25, 28, 35, 41, 43	Clearly pronounced distinctive word (barça)	EUTM No <a href="#">17 700 361</a>
 [sequence of four different tones, initially falling by a fourth and then rising and ending on the median]	16, 35, 42	Jingle-like sound sequences are capable of identifying goods and services.	<a href="#">R 2056/2013-4</a> KLANG DER PSD-BANK MUSIK (KLANGMARKE)
 [The first two shorter A notes sound less powerful than the following long and higher C note. The higher and longer C note is thus accentuated on account of its pitch, length and strength]	9, 16, 35, 36, 41, 42	According to general life experience, jingle-like sound sequences enable goods and services to be distinguished.	<a href="#">R 87/2014-5</a> KLANG EINER NOTENSEQUENZ (KLANGMARKE)
EUTM No <a href="#">18 063 460</a>	10: <i>electronical and medical apparatus and sanitary installations,</i>	The present jingle has a somewhat more complex sequence of tones than the usual operating signals from electronic devices, which are only perceived as simple signal tones (para. 19)	<a href="#">R 2821/2019-1</a> , 23/07/2020 (KLANG VON BASS: D3; A3, ACHTENPAUSE UND HÖHEN; E6; A5)

Sign	Goods and services	Reasoning	Case No
<a href="#">Link</a>	41: <i>Providing films for entertainment purposes</i>	The length and complexity of the sequence of notes gives it a certain resonance, enabling it to function as an indication of commercial origin. Therefore, the melody is considered distinctive for the services for which protection is sought.	CP11 example
(Sound of a mooing cow) <a href="#">Link</a>	11: <i>toilets</i>	The sound perceived in the mark has no link to the goods for which protection is sought and has sufficient resonance to be recognised by the consumer as an indication of commercial origin. Therefore, it is considered distinctive.	CP11 example

## 15 Motion Marks

[Article 3\(3\)\(h\) EUTMR](#) describes a **motion mark** as a trade mark consisting of, or extending to, a movement or a change in position of the elements of the mark. The term ‘extending to’ means that these marks cover not only the motion per se but also movements that contain word or figurative elements such as logos or labels.



The proposed definition does not restrict motion marks to those depicting movement. A sign may also qualify as a motion mark if it is capable of showing a change in the position of the elements (e.g. a sequence of stills), a change of colour or a change of elements understood as the replacement of one image by another. Motion marks do not include sound (see multimedia marks below).

In the absence of relevant case-law, the general criteria for assessing distinctiveness will apply to these marks. The mark will be distinctive within the meaning of [Article 7\(1\)\(b\) EUTMR](#) if it can identify the goods and/or services for which registration is sought as originating from a particular undertaking, and thus distinguish them from those of other undertakings. This distinctiveness will be assessed by reference, first, to the goods or services for which registration is sought and, second, to the relevant public’s



perception of that sign. These marks will not necessarily be perceived by the relevant public in the same way as a word or figurative mark.

In the framework of the European Union Intellectual Property Network, the trade mark offices of the European Union have agreed on a Common Practice in relation to new types of marks: examination of formal requirements and grounds for refusal. They agreed on examples of motion marks that are considered to be distinctive/non-distinctive in relation to the corresponding goods and/or services. Some examples are reproduced below, further examples can be found in the [CP11 Common Practice document](#).

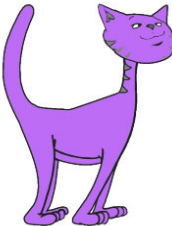
#### *Examples of accepted trade marks*

Partial representation of sign (for reference purposes)	Classes	Case No	Comments
	9, 35, 38, 41	EUTM No <a href="#">17 894 840</a>	Outline of a red apostrophe on a white background, over which appears the slogan 'The future is exciting', which is then replaced with the word 'Ready?'
	14	EUTM No <a href="#">17 911 214</a>	The word 'TIMEQUBE' on a white background, accompanied by a cube, which changes colour, from white to green to yellow to brown to red, and all shades in between.
	9: <i>computers</i>	<a href="#">CP11 example</a>	The figurative element in the motion mark is considered distinctive in itself. Combined with the changing colours the consumer will perceive it as indication of commercial origin for the goods applied for.

#### *Examples of non-acceptable trade marks*

Partial representation of sign (for reference purposes)	Classes	Case No	Comments
	3: <i>washing powder</i>	<a href="#">CP11 example</a>	Considering that the movement of the non-distinctive/descriptive verbal element 'Premium' is not unusual or striking, the sign is not capable of being recognised by the consumer as an indication of commercial origin. Therefore, the motion mark is considered non-distinctive.
	39: <i>travel services</i>	<a href="#">CP11 example</a>	This motion contains too many elements to leave a lasting impression on the consumer. It would be perceived just as a video clip of a street view. Therefore, it lacks inherent distinctiveness and will not be perceived as an indication of commercial origin.

## 16 Multimedia Marks



According to [Article 3\(3\)\(i\) EUTMR](#), a **multimedia mark** is a trade mark consisting of, or extending to, the combination of image and sound. The term 'extending to' means that these marks cover not only the combination of sound and image per se but also combinations that include word or figurative elements.

In the absence of relevant case-law, the general criteria for assessing distinctiveness will apply to these marks. The mark will be distinctive within the meaning of [Article 7\(1\)\(b\) EUTMR](#) if it can identify the goods and/or services for which registration is sought as originating from a particular undertaking, and thus distinguish them from those of other undertakings. This distinctiveness will be assessed by reference, first, to the goods or services for which registration is sought and, second, to the relevant public's

perception of that sign. The relevant public will not necessarily perceive these marks in the same way as a word or figurative mark.

In the framework of the European Union Intellectual Property Network, the trade mark offices of the European Union have agreed on a Common Practice in relation to new types of marks: examination of formal requirements and grounds for refusal. They agreed on examples of multimedia marks that are considered distinctive/non-distinctive for the corresponding goods and/or services. Some examples are shown below; further examples can be found in the [Common Communication on New Types of Marks: Examination of Formal Requirements and Grounds for Refusal \(CP11\)](#).

#### *Examples of acceptable trade marks*

Partial representation of sign (for reference purposes)	Classes	Case No	Comments
 <a href="#">Link</a>	45	<a href="#">EUTM No 17 279 704</a>	Registered
 Figure 2: <a href="#">Link</a>	31: <i>fresh bananas</i>	<a href="#">CP11 example</a>	Although the image is considered non-distinctive/descriptive in relation to goods applied for, the combination with a distinctive verbal element, which is perceived in the multimedia mark, renders the mark distinctive.

#### *Examples of non-acceptable trade marks*

Partial representation of sign (for reference purposes)	Classes	Case No	Comments

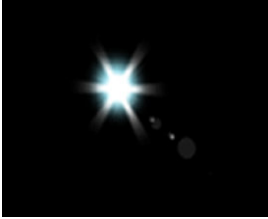
 <p><a href="#">Link</a></p>	3: <i>washing powder</i>	<a href="#">CP11 example</a>	The banality of the image and the sound, combined with the shortness of the video do not create a lasting impression on the consumer. Therefore, it lacks inherent distinctiveness and will not be perceived as an indication of commercial origin.
---	--------------------------	------------------------------	---

## 17 Hologram Marks

[Article 3\(3\)\(j\) EUTMR](#) defines a **hologram mark** as a trade mark consisting of elements with holographic characteristics.

In the absence of relevant case-law, the general criteria for assessing distinctiveness will apply to these marks. The mark will be distinctive within the meaning of [Article 7\(1\)\(b\) EUTMR](#) if it can identify the goods and/or services for which registration is sought as originating from a particular undertaking, and thus distinguish them from those of other undertakings. This distinctiveness will be assessed by reference, first, to the goods or services for which registration is sought and, second, to the relevant public's perception of that sign. The relevant public will not necessarily perceive these marks in the same way as a word or figurative mark.

In the framework of the European Union Intellectual Property Network, the trade mark offices of the European Union have agreed on a Common Practice in relation to new types of marks: examination of formal requirements and grounds for refusal. They agreed on examples of hologram marks that are considered distinctive/non-distinctive for the corresponding goods and/or services. An example is reproduced below; further examples can be found in the [Common Communication on New Types of Marks: Examination of Formal Requirements and Grounds for Refusal \(CP11\)](#).

*Example of an acceptable trade mark*

Partial representation of sign (for reference purposes)	Classes	Case No	Comments

 <a href="#">Link</a>	12: cars	<a href="#">CP11 example</a>	The combination of the distinctive verbal and figurative elements in the hologram mark makes the hologram mark distinctive as a whole.
---	----------	------------------------------	--

***GUIDELINES FOR EXAMINATION OF  
EUROPEAN UNION TRADE MARKS***

***EUROPEAN UNION  
INTELLECTUAL PROPERTY OFFICE  
(EUIPO)***

***Part B***

***Examination***

***Section 4***

***Absolute grounds for refusal***

***Chapter 4***

***Descriptive trade marks (Article 7(1)(c)  
EUTMR)***



## Table of Contents

<b>1 General Remarks.....</b>	<b>468</b>
1.1 The notion of descriptiveness.....	468
1.2 Characteristics mentioned under Article 7(1)(c) EUTMR.....	468
1.3 Common misunderstandings.....	470
1.3.1 Term not used.....	470
1.3.2 Need to keep free.....	470
1.3.3 Factual monopoly.....	471
1.3.4 Double meaning.....	471
<b>2 Word Marks.....</b>	<b>471</b>
2.1 One word.....	471
2.2 Combinations of words.....	472
2.3 Misspellings and omissions.....	475
2.4 Abbreviations and acronyms.....	477
2.5 Slogans.....	478
2.6 Geographical terms.....	479
2.6.1 Preliminary remarks.....	479
2.6.2 Assessment of geographical terms.....	479
2.7 Terms describing subject matter in goods or services.....	487
2.7.1 General considerations.....	487
2.7.2 Titles of books.....	490
2.8 Single letters and numerals.....	491
2.9 Names of colours.....	493
2.10 Names of banks, newspapers/magazines and airports.....	496
2.11 Names of hotels.....	499
2.12 Combinations of names of countries/cities with a number indicating a year.....	500
2.13 INN codes.....	501
<b>3 Figurative Marks.....</b>	<b>502</b>
<b>4 Figurative Threshold.....</b>	<b>504</b>
4.1 Preliminary remarks.....	504
4.2 Assessment of the figurative threshold.....	505
4.2.1 Word elements in a mark.....	506
4.2.2 Figurative elements (word element(s) and additional figurative element(s)).....	510
4.2.3 Word and figurative elements (stylised word elements and additional figurative element(s)).....	517

<b>5 Descriptiveness in the context of CP11 (sound marks, motion marks, multimedia marks and hologram marks)</b> .....	<b>519</b>
5.1 Sound marks.....	519
5.2 Motion marks .....	520
5.3 Multimedia marks .....	520
5.4 Hologram marks .....	521

## 1 General Remarks

### 1.1 The notion of descriptiveness

A sign must be refused as descriptive if it has a meaning that is immediately perceived by the relevant public as providing information about the goods and services applied for. This is the case where the sign provides information about, inter alia, the quantity, quality, characteristics, purpose, kind and/or size of the goods or services. The relationship between the term and the goods and services must be sufficiently direct and specific (20/07/2004, [T-311/02](#), Limo, EU:T:2004:245, § 30; 30/11/2004, [T-173/03](#), Nurseryroom, EU:T:2004:347, § 20), as well as concrete, direct and understood without further reflection (26/10/2000, [T-345/99](#), Trustedlink, EU:T:2000:246, § 35). If a mark is descriptive, it is also non-distinctive.

[Article 7\(1\)\(c\) EUTMR](#) does not apply to those terms that are only suggestive or allusive as regards certain characteristics of the goods and/or services. Sometimes this is also referred to as vague or indirect references to the goods and/or services (31/01/2001, [T-135/99](#), Cine Action, EU:T:2001:30, § 29).

The public interest underlying [Article 7\(1\)\(c\) EUTMR](#) is that exclusive rights should not exist for purely descriptive terms that other traders might wish to use as well. However, it is not necessary for the Office to show that there is already a descriptive use by the applicant or its competitors. Consequently, the number of competitors that could be affected is totally irrelevant. Therefore, if a word is descriptive in its ordinary and plain meaning, this ground for refusal cannot be overcome by showing that the applicant is the only person who produces, or is capable of producing, the goods in question.

Regarding the baseline for objections, see the Guidelines, [Part B, Examination, Section 4, Absolute grounds for refusal, Chapter 1, General principles, paragraph 4.2](#)

### 1.2 Characteristics mentioned under Article 7(1)(c) EUTMR

The term 'characteristic' in [Article 7\(1\)\(c\) EUTMR](#) designates a property, easily recognisable by the relevant public for the goods or the services in respect of which registration is sought. Consequently, a sign can be refused registration under this provision only if it is reasonable to believe that it will actually be recognised by the relevant public as a description of one of those characteristics (10/03/2011, [C-51/10 P](#), 1000, EU:C:2011:139, § 50).

It is irrelevant whether this characteristic is commercially essential or ancillary (16/10/2014, [T-458/13](#), Graphene, EU:T:2014:891, § 20). However, a characteristic within the meaning of [Article 7\(1\)\(c\) EUTMR](#) must be 'objective' and 'inherent to the nature of that product' or service (06/09/2018, [C-488/16 P](#), NEUSCHWANSTEIN, EU:C:2018:673, § 44) and 'intrinsic and permanent' with regard to that product or service (07/05/2019, [T-423/18](#), vita, EU:T:2019:291, § 44).

### Kind of goods and services

This includes the goods or services themselves, that is, their type or nature. For example, 'bank' for financial services, Perle' for wines and sparkling wines (01/02/2013, [T-104/11](#), Perle', EU:T:2013:51,) or 'Universaltelefonbuch' for a universal telephone directory (14/06/2001, [T-357/99](#) & [T-358/99](#), Universaltelefonbuch, EU:T:2001:162) or constituent parts or components of the goods (15/01/2013, [T-625/11](#), EcoDoor, EU:T:2013:14, § 26).

### Quality

This includes both laudatory terms, referring to a superior quality of the respective goods or services, as well as the inherent quality of the goods or services. It covers terms such as 'light', 'extra', 'fresh', 'hyper light' for goods that can be extremely light (27/06/2001, [R 1215/2000-3](#), Hyperlite). In addition, figures may refer to the quality of a product or a service, such as 24/7 for service availability; '2000', which refers to the size of the motor or '75', which refers to the horse power (kW) of the motor.

### Quantity

This covers indications of the quantity in which the goods could be sold, such as 'six pack' for beer, 'one litre' for drinks, '100' (grams) for chocolate bars. Only quantity measurements relevant in trade, not those that are hypothetically possible, count. For example, 99.999 for bananas would be acceptable.

### Intended purpose

The intended purpose is the function of a product or service, the result that is expected from its use or, more generally, the use for which the good or service is intended. An example is 'Trustedlink' for goods and services in the IT sector aimed at securing a safe (trusted) link (26/10/2000, [T-345/99](#), Trustedlink, EU:T:2000:246). Marks that have been refused registration on this basis include 'Therapy' for massage tools (08/09/1999, [R 144/1999-3](#), THERAPY) and 'Slim belly' for fitness training apparatus, sport activities, medical and beauty care services (30/04/2013, [T-61/12](#), Slim belly, EU:T:2013:226). This objection also applies as regards accessories: a term that described the type of goods also describes the intended purpose for accessories to those goods. Therefore, 'Rockbass' is liable to objection for accessories for rock guitars (08/06/2005, [T-315/03](#), Rockbass, EU:T:2005:211 (appeal [C-301/05 P](#) settled)).

### Value

This covers both the (high or low) price to be paid, as well as the value in quality. It therefore does not only refer to expressions such as 'extra' or 'top', but also expressions such as 'cheap' or 'more for your money'. It also includes expressions indicating, in common parlance, goods or services that are superior in quality.

### Geographical origin

See [paragraph 2.6](#).

### Time of production of the goods or of rendering of the service

This covers expressions concerning the time at which services are rendered, either expressly ('evening news', '24 hours') or in a usual manner (24/7). It also covers the

time at which goods are produced if that is relevant for the goods (late vintage for wine). For wine, the numeral '1998' indicating the vintage year would be relevant, but not for chocolate.

#### Other characteristics

This covers other characteristics of the goods or services and shows that the preceding list of items in [Article 7\(1\)\(c\) EUTMR](#) is not exhaustive. In principle, any characteristic of the goods and services must lead to a refusal under [Article 7\(1\)\(c\) EUTMR](#). It does not matter whether the characteristics of the goods or services are commercially essential or merely ancillary or whether there are synonyms of those characteristics (12/02/2004, [C-363/99](#), Postkantoor, EU:C:2004:86, § 102; 24/04/2012, [T-328/11](#), EcoPerfect, EU:T:2012:197, § 41).

#### *Examples of 'other characteristics'*

- the subject matter contained within the goods or services for which protection is sought: (see [paragraph 2.7](#));
- the identification of the targeted consumer: 'BIMBO' [child in English] for *bread* (18/03/2016, [T-33/15](#), BIMBO, EU:T:2016:159) or 'ellos' [they/them in English] (27/02/2002, [T-219/00](#), Ellos, EU:T:2002:44) for *clothing*.

## **1.3 Common misunderstandings**

Applicants often put forward arguments that have already been declared irrelevant by the courts. These arguments will be dismissed by the Office in its decision.

### **1.3.1 Term not used**

The fact that a descriptive use of the term applied for cannot be ascertained is irrelevant. Examination of [Article 7\(1\)\(c\) EUTMR](#) has to be made by means of prognostics (assuming that the mark will be used with respect to the goods or services claimed). It follows clearly from the text of [Article 7\(1\)\(c\) EUTMR](#) that it suffices if the mark 'may serve' to designate characteristics of the goods and services (23/10/2003, [C-191/01 P](#), Doublemint, EU:C:2003:579, § 33).

### **1.3.2 Need to keep free**

It is frequently claimed that other traders do not need the term applied for, can use more direct and straightforward indications or have synonyms at their disposal to describe the respective characteristics of the goods. All these arguments must be refused as irrelevant.

Although there is a public interest underlying [Article 7\(1\)\(c\) EUTMR](#) that descriptive terms should not be registered as trade marks so as to remain freely available to all competitors, it is not necessary for the Office to show that there is, on the part of third parties, a present or future need to use, or concrete interest in using, the descriptive term applied for (no *konkretes Freihaltebedürfnis*) (04/05/1999, [C-108/97](#) & [C-109/97](#),

Chiemsee, EU:C:1999:230, § 35; 12/02/2004, [C-363/99](#), Postkantoor, EU:C:2004:86, § 61).

Whether there are synonyms or other, even more usual, ways of expressing the descriptive meaning is thus irrelevant (12/02/2004, [C-265/00](#), Biomild, EU:C:2004:87, § 42).

### 1.3.3 Factual monopoly

The fact that the applicant is the only person offering the goods and services for which the mark is descriptive is not relevant for [Article 7\(1\)\(c\) EUTMR](#). However, in this case the applicant will be more likely to succeed on acquired distinctiveness.

### 1.3.4 Double meaning

The argument frequently put forward by applicants that the terms applied for have more than one meaning, one of them not being descriptive for the goods/services, should be rejected. It suffices for a refusal under [Article 7\(1\)\(c\) EUTMR](#) if at least one of the possible meanings of the term is descriptive in relation to the relevant goods and services (23/10/2003, [C-191/01 P](#), Doublemint, EU:C:2003:579, § 32; confirmed by 12/02/2004, [C-363/99](#), Postkantoor, EU:C:2004:86, § 97).

Given that the examination must focus on the goods/services covered by the application, arguments concerning other possible meanings of the word(s) making up the trade mark applied for (that are unrelated to the goods/services concerned) are irrelevant. Equally, when the trade mark applied for is a composite word mark, what matters for examination purposes is the meaning, if any, associated with the sign considered **as a whole**, and not the possible meanings of its individual elements considered separately (08/06/2005, [T-315/03](#), Rockbass, EU:T:2005:211, § 56).

## 2 Word Marks

### 2.1 One word

Descriptive terms are those that merely consist of information about the characteristics of the goods and services. This means that descriptive terms cannot fulfil the function of a trade mark. Consequently, the ground for refusal applies irrespective of whether a term is already used by other competitors in a descriptive manner for the goods and services at issue.

In particular, a word is descriptive if either for the general public (if the goods or services target them) or for a specialised public (irrespective of whether the goods or services also target the general public) the trade mark has a descriptive meaning.

- The term 'RESTORE', is descriptive for surgical and medical instruments and apparatus; stents; catheters; and guide wires (17/01/2013, [C-21/12 P](#), Restore, EU:C:2013:23).
- 'CONTINENTAL' is descriptive for 'live animals, that is to say, dogs' and 'the keeping and breeding of dogs, that is to say, puppies and animals for breeding'. Indeed, the word 'Continental' indicates a breed of bulldogs (17/04/2013, [T-383/10](#), Continental, EU:T:2013:193).
- 'TRILOBULAR' is descriptive for screws. It would be immediately perceived by professionals as describing the fact that the screw is made up of three lobes, and thus describes a quality or characteristic, which is, moreover fundamental, of those goods (18/11/2015, [T-558/14](#), TRILOBULAR, EU:T:2015:858, § 32).

Furthermore, as seen above, objections should also be raised against terms that describe desirable characteristics of the goods and services.

However, it is important to distinguish laudatory terms that describe — although in general terms — desirable characteristics of goods and services as being cheap, convenient, of high quality, etc. and that are excluded from registration, from those terms that are laudatory in a broader sense, that is to say, they refer to vague positive connotations or to the person of the purchaser or producer of the goods without specifically referring to the goods and services themselves.

Not descriptive:

- 'BRAVO', as it is unclear who says 'BRAVO' to whom, and what is being praised (04/10/2001, [C-517/99](#), Bravo, EU:C:2001:510).

## 2.2 Combinations of words

As a general rule, a **mere combination of elements**, each of which is descriptive of characteristics of the goods or services themselves, remains descriptive of those characteristics. Merely bringing those elements together without introducing unusual variations, in particular as to syntax or meaning, cannot result in anything other than a descriptive sign.

However, if due to the **unusual nature of the combination** in relation to the goods or services, a combination creates an **impression that is sufficiently far removed** from that produced by the mere combination of meanings lent by the elements of which it is composed, that combination will be considered **more than the sum of its parts** (12/02/2004, [C-265/00](#), Biomild, EU:C:2004:87, § 39, 43). These notions, 'unusual nature of the combination', 'impression sufficiently far removed' and 'more than the sum of its parts' have to be interpreted as meaning that [Article 7\(1\)\(c\) EUTMR](#) does not apply when the way in which the two descriptive elements are combined is in itself fanciful.

The following examples have been **refused** registration:

- 'Biomild' for yoghurt being mild and organic (12/02/2004, [C-265/00](#), Biomild, EU:C:2004:87);

- ‘Companyline’ for insurance and financial affairs (19/09/2002, [C-104/00 P](#), Companyline, EU:C:2002:506);
- ‘Trustedlink’ for software for e-commerce, business consulting services, software integration services and education services for e-commerce technologies and services (26/10/2000, [T-345/99](#), Trustedlink, EU:T:2000:246);
- ‘Cine Comedy’ for the broadcast of radio and television programmes, production, showing and rental of films, and allocation, transfer, rental and other exploitation of rights to films (31/01/2001, [T-136/99](#), Cine Comedy, EU:T:2001:31);
- ‘Teleaid’ for electronic devices for transferring speech and data, repair services for automobiles and vehicle repair, operation of a communications network, towing and rescue services and computing services for determining vehicle location (20/03/2002, [T-355/00](#), Tele Aid, EU:T:2002:79);
- ‘Quick-gripp’ for hand tools, clamps and parts for tools and clamps (27/05/2004, [T-61/03](#), Quick-Grip, EU:T:2004:161);
- ‘Twist and Pour’ for handheld plastic containers sold as an integral part of a liquid paint containing, storage and pouring device (12/06/2007, [T-190/05](#), Twist & Pour, EU:T:2007:171);
- ‘CLEARWIFI’ for telecommunications services, namely high-speed access to computer and communication networks (19/11/2009, [T-399/08](#), Clearwifi, EU:T:2009:458);
- ‘STEAM GLIDE’ for electric irons, electric flat irons, electric irons for ironing clothes, parts and fittings for the aforementioned goods (16/01/2013, [T-544/11](#), Steam Glide, EU:T:2013:20);
- ‘GREENWORLD’ for, inter alia, gas fuels, fuels, electric power, gas for lighting, retail services in the areas of fuels, transmission and transport of electrical energy, heat, gas or water (27/02/2015, [T-106/14](#), Greenworld, EU:T:2015:123);
- ‘Greenline’ for goods in Classes 1, 5, 6, 8, 20 and 21 that can conform to a philosophy of care for the environment (30/03/2007, [R 125/2007-2](#), GREENLINE, § 15-22);
- ‘ecoDOOR’ for products on which doors have a significant impact, such as dishwashers, washing machines, vending machines, apparatus for cooking (10/07/2014, [C-126/13 P](#), EcoDoor, EU:C:2014:2065).

In the same way, combinations of the **prefix ‘EURO’** with purely descriptive terms must be refused where the ‘EURO’ element reinforces the descriptiveness of the sign as a whole or where there is a reasonable connection between that term and the goods or services concerned. This is in line with the judgment of 07/06/2001, [T-359/99](#), EuroHealth, EU:T:2001:151.

The following examples have been **accepted for** registration:

- GREENSEA for goods and services in Classes 1, 3, 5 and 42;
- MADRIDEXPORTA for Classes 16, 35, 36, 38, 39, 41 and 42 (16/09/2009, [T-180/07](#), Madridexporta, EU:T:2009:334);
- DELI FRIENDS for Classes 29, 30 and 35.

Combinations not following grammatical rules



A combination of words can be considered a descriptive indication even though it does not follow the usual grammatical rules. If, however, the combination does amount to more than the mere sum of its parts, it may be acceptable (17/10/2007, [T-105/06](#), WinDVD Creator, EU:T:2007:309, § 34).

- ‘HIPERDRIVE’ is considered descriptive of the intended purpose of setting devices for tools, despite the misspelling of the adjective ‘hyper’ as ‘hiper’ (22/05/2014, [T-95/13](#), Hiperdrive, EU:T:2014:270, § 33-42).
- ‘CARBON GREEN’ is descriptive for reclaimed rubber, namely, recycled carbonaceous materials, namely plastic, elastomeric, or rubber filled materials obtained from pyrolysed tire char and plastic, elastomeric, or rubber compounds formulated using such filler material, even though adjectives precede nouns in English (11/04/2013, [T-294/10](#), Carbon green, EU:T:2013:165).

Furthermore, in the world of advertising, definite articles and pronouns (the, it, etc.), conjunctions (or, and, etc.) or prepositions (of, for, etc.) are frequently omitted. This means that a lack of these grammatical elements will sometimes not be sufficient to make the mark distinctive.

#### Combinations of adjectives + nouns or verbs

For combinations consisting of **nouns and adjectives**, it should be assessed whether the meaning of the combination changes if its elements are inverted. For example, ‘Vacations direct’ (not registrable, 23/01/2001, [R 33/2000-3](#)) is tantamount to ‘direct vacations’, whereas ‘BestPartner’, is not the same thing as ‘PartnerBest’.

The same reasoning applies to words consisting of the **combination of an adjective and a verb**. Therefore, the word ‘ULTRAPROTECT’ must be considered descriptive for sterilising and sanitary preparations, even though it consists of the combination (grammatically incorrect) of an adjective (ULTRA) with a verb (PROTECT), since its meaning remains clearly understandable (03/06/2013, [R 1595/2012-1](#), ULTRAPROTECT; 06/03/2012, [T-565/10](#), Highprotect, EU:T:2012:107).

#### Combinations of words in different languages

Combinations made up of words from different languages may still be liable to objection if the relevant consumers will understand the descriptive meaning of all the elements without further effort. This may be the case, in particular, when the sign contains basic terms in a language that will be understood easily by the speakers of another language, or if the terms are similar in both languages. For instance, if a mark is composed of one basic descriptive term belonging to language ‘A’ and another descriptive word in language ‘B’, the sign as a whole will remain descriptive when it is assumed that the speakers of language ‘B’ will be able to grasp the meaning of the first term.

Applications that consist of descriptive words or expressions repeated in various languages are a special case in the sense that they are mere translations of each other. These trade marks should be considered descriptive if the relevant consumer will grasp that each of the words or expressions is in fact merely the translation of a descriptive meaning, for example, because the proximity of the terms contained in the

mark to each other will lead the consumer to understand that they all have the same descriptive meaning in different languages. For instance:

- EUTM No 3 141 017 ‘Le salon virtuel de l’industrie — Industry virtual exhibition — Die virtuelle Industriemesse — Il salon virtuale dell’industria — El salon virtual de la industria’ for services in Classes 35, 38 and 42.

The following examples have been **refused** registration:

- EUTM No 12 596 169 ‘BABYPATAUGEOIRE’ for Classes 20 and 42 related to chairs and design of chairs for babies. The sign is composed of an EN and a FR term that will be immediately understood by the French-speaking part of the public (the term ‘baby’ will be understood by the French-speaking part of the public);
- ‘EURO AUTOMATIC PAIEMENT’, for Classes 9 and 36 (05/09/2012, [T-497/11](#), Euro automatic paiement, EU:T:2012:402, combination of English and French terms).

## 2.3 Misspellings and omissions

A misspelling does not necessarily change the descriptive character of a sign. First of all, words may be misspelt due to influences from another language or the spelling of a word in non-EU areas, such as American English, in slang or to make the word more fashionable. Examples of signs that have been refused:

- ‘Xtra’ (27/05/1998, [R 20/1997-1](#));
- ‘Xpert’ (27/07/1999, [R 230/1998-3](#));
- ‘Easi-Cash’ (20/11/1998, [R 96/1998-1](#));
- ‘Lite’ (27/02/2002, [T-79/00](#), Lite, EU:T:2002:42);
- ‘Rely-able’ (30/04/2013, [T-640/11](#), Rely-able, EU:T:2013:225);
- ‘FRESHHH’ (26/11/2008, [T-147/06](#), Freshhh, EU:T:2008:528).

Furthermore, consumers will, without further mental steps, understand the ‘@’ as the letter ‘a’ or the word ‘at’ and the ‘€’ as the letter ‘e’. Consumers will replace specific numerals by words, for example, ‘2’ as ‘to’ or ‘4’ as ‘for’.

However, if the misspelling is fanciful and/or striking or changes the meaning of the word (accepted: ‘D’LICIOUS’, EUTM No 13 729 348 (instead of ‘delicious’), ‘FANTASTICK’, EUTM No 13 820 378 (instead of ‘fantastic’)), the sign is acceptable.

As a rule, misspellings endow the sign with a sufficient degree of distinctive character when:

- they are striking, surprising, unusual, arbitrary and/or;
- they are capable of changing the meaning of the word element or require some mental effort from the consumer in order to make an immediate and direct link with the term that they supposedly refer to.

The following marks were refused.

Sign	Reasoning	Case No
<p><b>ACTIVMOTION SENSOR</b></p> <p>EUTM No 10 282 614 for goods in Class 7 (swimming pool and spa cleaning equipment, namely, sweepers, vacuums, and parts therefor)</p>	<p>The mark merely consists of 'ACTIV' (an obvious misspelling of the word 'ACTIVE'), 'MOTION' and 'SENSOR'. Combined, the words form a perfectly comprehensible and plainly descriptive combination, and the mark was thus refused.</p>	<p>06/08/2012, <a href="#">R 716/2012-4</a>, ACTIVMOTION SENSOR, § 11</p>
<p><b>XTRAORDINARIO</b></p> <p>International registration designating the EU No 930 778, for goods in Class 33 (<i>tequila</i>)</p>	<p>The above term is a non-existent word but closely resembles the Spanish adjective 'extraordinario'. Spanish and Portuguese consumers will perceive the sign as a misspelling of a word meaning 'remarkable', 'special', 'outstanding', 'superb' or 'wonderful', and as such, attribute a descriptive meaning to the sign.</p>	<p>04/07/2008, <a href="#">R 169/2008-1</a>, Xtraordinario, § 11-12</p>

However, the following marks were **accepted**.

Sign	Reasoning	Case No
<p><b>LINQ</b></p> <p>EUTM No 1 419 415 covering goods and services in Classes 9 and 38</p>	<p>This word is an invented word, not existing in any known dictionary, and it was not shown that this word is a common misspelling used in the trade circles of interest to the appellant. Additionally, because the word is short, the ending letter 'Q' will be noticed as a peculiar element, and thus the fanciful spelling is obvious</p>	<p>04/02/2002, <a href="#">R 9/2001-1</a>, LINQ, § 13</p>

Sign	Reasoning	Case No
<p><b>LIQID</b></p> <p>EUTM No 5 330 832 initially covering goods in Classes 3, 5 and 32</p>	<p>In this word mark, the combination 'QI' is highly uncommon in the English language, as the letter 'Q' is normally followed by a 'U'. The striking misspelling of the word 'liquid' would allow even a consumer in a hurry to notice the peculiarity of the word 'LIQID'. Furthermore, the spelling would not only have an effect on the visual impression produced by the sign, but also the aural impression, as the sign applied for will be pronounced differently from the word 'liquid'.</p>	<p>22/02/2008, <a href="#">R 1769/2007-2</a>, LIQID, § 25</p>

## 2.4 Abbreviations and acronyms

Abbreviations of descriptive terms are in themselves descriptive if they are used in that way, and the relevant public, whether general or specialised, recognises them as being identical to the full descriptive meaning. The mere fact that an abbreviation is derived from a descriptive term is not sufficient (13/06/2014, [T-352/12](#), Flexi, EU:T:2014:519).

The following signs were refused because the descriptive meaning for the relevant public could clearly be shown:

- SnTEM (12/01/2005, [T-367/02](#) – [T-369/02](#), SnTEM, SnPUR & SnMIX, EU:T:2005:3);
- TDI 03/12/2003, [T-16/02](#), TDI, EU:T:2003:327 (appeal [C-82/04 P](#) was settled);
- LIMO (20/07/2004, [T-311/02](#), Limo, EU:T:2004:245);
- BioID (05/12/2002, [T-91/01](#), BioID, EU:T:2002:300 (appeal [C-37/03 P](#) set aside the Court's judgment and dismissed the decision of the second BoA)).

Note that use of internet databases such as 'AcronymFinder.com' as a reference base should be made with due consideration. Use of technical reference books or scientific literature is preferable, for example, in the field of computing. Alternatively, use of the abbreviation by a number of traders in the appropriate field on the internet is sufficient to substantiate actual use of the abbreviation.

Signs consisting of an independently non-descriptive acronym that precedes or follows a descriptive word combination should be objected to as descriptive if it is perceived by the relevant public as merely a word combined with an abbreviation of that word combination, for example 'Multi Markets Fund MMF'. This is because the acronym and

word combination together are intended to clarify each other and to draw attention to the fact that they are linked (15/03/2012, [C-90/11](#) & [C-91/11](#), Natur-Aktien-Index / Multi Markets Fund, EU:C:2012:147, § 32, 34, 40). This will be the case even where the acronym does not account for the mere ‘accessories’ in the word combination, such as articles, prepositions or punctuation marks, such as in the following example: ‘The Statistical Analysis Corporation — SAC’.

While the above rule will cover most cases, not all instances of descriptive word combinations juxtaposed with an abbreviation of that word will be considered descriptive as a whole. This will be the case where the relevant public will not immediately perceive the acronym as an abbreviation of the descriptive word combination, but rather as a distinctive element that will make the sign as a whole more than the sum of its individual parts, as demonstrated in the following example:

- ‘The Organic Red Tomato Soup Company — ORTS’.

## 2.5 Slogans

A slogan gives rise to an objection under [Article 7\(1\)\(c\) EUTMR](#) when it immediately conveys the kind, quality, intended purpose or other characteristics of the goods or services.

The criteria established by case-law for the purpose of determining whether a slogan is descriptive or not are identical to those applied in the case of a word mark containing only a single element (06/11/2007, [T-28/06](#), Vom Ursprung her vollkommen, EU:T:2007:330, § 21). It is inappropriate to apply criteria to slogans that are stricter than those applicable to other types of signs, especially considering that the term ‘slogan’ does not refer to a special subcategory of signs (12/07/2012, [C-311/11 P](#), Wir machen das Besondere einfach, EU:C:2012:460, § 26, 40).

### Example of a descriptive slogan

- An application in Class 9 (*satellite navigation systems*, etc.) for ‘FIND YOUR WAY’, (18/07/2007, [R 1184/2006-4](#)) was objected to under Article 7(1)(b) and (c) EUTMR. The expression ‘FIND YOUR WAY’ in relation to the goods applied for in Class 9 is clearly intended to inform the relevant consumer that the appellant’s goods help consumers to identify geographical locations in order to find their way. The message conveyed by the sign applied for directly refers to the fact that consumers will discover the route for travelling from one place to another when using the specified goods.
- ‘BUILT TO RESIST’ could have only one possible meaning in relation to paper, paper goods and office requisites in Class 16, leather, imitations of leather, travel articles not included in other classes and saddlery in Class 18 and clothing, footwear and headgear in Class 25, namely that the goods are manufactured to last and are, therefore, tough and resistant to wear and tear (16/09/2009, [T-80/07](#), Built to resist, EU:T:2009:332, § 27-28).

### Example of a non-descriptive slogan

- ‘WET DUST CAN’T FLY’ does not describe the way in which the cleaning preparations, appliances and services in Classes 3, 7 and 37 operate. Cleaning preparations are not designed to moisten dust in order to prevent it from dispersing, but to make the dirt disintegrate and disappear. Cleaning appliances filter the dust through liquids but are not designed to dampen the dust in order to prevent it from flying (22/01/2015, [T-133/13](#), WET DUST CAN’T FLY, EU:T:2015:46, § 23-24, 27).

## 2.6 Geographical terms

### 2.6.1 Preliminary remarks

A geographical term is every existing name of a place, for example a country, region, city, lake or river. This list is not exhaustive. Adjectival forms are not sufficiently different from the original geographical term to cause the relevant public to think of something other than that geographical term (15/10/2003, [T-295/01](#), Oldenburger, EU:T:2003:267, § 39). For example, ‘German’ will still be perceived as referring to Germany, and ‘French’ will still be perceived as referring to France. Furthermore, outdated terms such as ‘Ceylon’, ‘Bombay’ and ‘Burma’ fall within this scope if they are still commonly used or generally understood by consumers as a designation of origin.

It is in the **public interest** that signs that may serve to designate the geographical origin of goods or services remain available, not least because they may be an indication of the quality and other characteristics of the categories of goods concerned, and may also, in various ways, influence consumer preferences by, for instance, associating the goods or services with a place that may elicit a favourable response (15/01/2015, [T-197/13](#), MONACO, EU:T:2015:16, § 47; 25/10/2005, [T-379/03](#), Cloppenburg, EU:T:2005:373, § 33).

This paragraph ([2.6](#)) uses the words ‘geographical term’ to refer to **any** geographical indication in an EUTM application, whereas the terms ‘protected geographical indication’ and ‘protected designation or appellation of origin’ are used **only** in the context of specific legislation protecting them. Designations of origin and geographical indications protected under specific EU regulations are dealt with under the section on [Article 7\(1\)\(j\) EUTMR](#).

### 2.6.2 Assessment of geographical terms

The registration of geographical names as trade marks is not possible where such a geographical name is either **already famous**, or is **known for the category of goods concerned**, and is therefore **associated** with those goods or services in the mind of the relevant class of persons, or it is **reasonable to assume** that the term may, in view of the relevant public, designate the geographical origin of the category of goods and/or services concerned (15/01/2015, [T-197/13](#), MONACO, EU:T:2015:16, § 48; 25/10/2005, [T-379/03](#), Cloppenburg, EU:T:2005:373, § 34).

As with all other descriptive terms, the test is whether the geographical term **describes objective characteristics of the goods and services**. The assessment must be made with reference to the goods and services for which protection is sought **and** with reference to the perception by the relevant public.

Under this part of the Guidelines, the descriptive character of the geographical term may relate to:

- the place of production of the goods;
- the place where the goods were conceived and designed (06/09/2018, [C-488/16 P](#), NEUSCHWANSTEIN, EU:C:2018:673, § 48);
- the place where the services are rendered;
- the place that influences consumer preferences (e.g. lifestyle) by eliciting a favourable response (15/01/2015, [T-197/13](#), MONACO, EU:T:2015:16, § 47; 25/10/2005, [T-379/03](#), Cloppenburg, EU:T:2005:373, § 33).

The use of geographical names as trade marks is also dealt with in other parts of the Guidelines. For example, where such a sign indicates the subject matter of the goods and/or services, the relevant part of the Guidelines applies (i.e. [paragraph 2.7](#) below on subject matter).

The following two-step assessment must be carried out when assessing geographical names as trade marks.

**First step:** term is understood by the relevant public as a geographical name.

The **first step** in assessing a geographical term is to determine whether it is understood as such by the relevant public. [Article 7\(1\)\(c\) EUTMR](#) does not in principle preclude the registration of geographical names that are unknown to the relevant public — or at least unknown as the designation of a geographical location (15/01/2015, [T-197/13](#), MONACO, EU:T:2015:16, § 49; [T-379/03](#), Cloppenburg, EU:T:2005:373, § 36). Whether or not this is the case will be determined by taking as a basis a reasonably well-informed consumer who has sufficient common knowledge but is not a specialist in geography. For an objection to be raised, the Office must prove that the geographical term is known by the relevant public as designating a place (15/01/2015, [T-197/13](#), MONACO, EU:T:2015:16, § 51).

**Second step:** term either (a) designates a place associated with the goods and services or (b) may be reasonably assumed to designate the geographical origin of the goods and services.

The second step is to determine whether the geographical term applied for designates a place that **is currently** associated with the claimed goods or services in the mind of the relevant public or whether **it is reasonable to assume** that it will be associated with those goods or services in the future (04/05/1999, [C-108/97](#) & [C-109/97](#), Chiemsee, EU:C:1999:230, § 31), or whether such a name may, in the mind of the relevant public, designate the geographical origin of that category of goods or services (15/01/2015, [T-197/13](#), MONACO, EU:T:2015:16, § 48; [T-379/03](#), Cloppenburg, EU:T:2005:373, § 34).



In establishing whether such an association exists, the Court has clarified that the following factors should be taken into account (04/05/1999, [C-108/97](#) & [C-109/97](#), Chiemsee, EU:C:1999:230, § 32, 37; [T-379/03](#), Cloppenburg, EU:T:2005:373, § 38), namely the degree of familiarity with:

- the geographical term;
- the characteristics of the place designated by the term; and
- the category of goods or services.

1. Places **currently associated** with the claimed goods or services

Geographical names that designate specified geographical locations that are already famous or are known for the category of goods or services concerned, and that are therefore associated with that category in the mind of the relevant class of persons, may not be registered as trade marks (15/10/2003, [T-295/01](#), Oldenburger, EU:T:2003:267, § 31).

For example, 'Milano' should be refused for clothing, 'Frankfurt' for financial services, 'Islas Canarias' for sightseeing, tour guide and excursion services and 'Switzerland' for banking services, cosmetic products, chocolate and watches.

Sign	Reasoning	Case No
ST ANDREWS Classes 25, 28, 35 and 41	The Court considered that the services in Class 41 could all directly relate to golf sports, and in particular to the organisation and planning of golf events, competitions, conferences, congresses, seminars, exhibitions and training, including club services and publications related to the aforesaid, that is to the particular field for which the town of St Andrews was well known. (para. 35).	20/11/2018, <a href="#">T-790/17</a> , ST ANDREWS, EU:T:2018:811



<p>KARELIA</p> <p>Classes 4 and 10</p>	<p>Karelia is a region situated in Finland with historic ties to Sweden.</p> <p>In order to come to the finding that the mark applied for will be perceived by the relevant public as describing the geographical origin of the relevant goods, the Board of Appeal took into account the considerable reputation of the Karelia region for the production of biomass and biofuels and the awareness that the public has of the importance of that industry and of bioenergy production in Finland and, more specifically, in the Karelia region. Consequently, the Board of Appeal was entitled, taking into account the characteristics of that region and the awareness that the relevant public has of it, to find that the word 'karelia' referred to a place that currently has a connection with the relevant goods in the mind of the relevant public, at the very least as regards the Finnish public (para. 31).</p>	<p>06/10/2017,</p> <p><a href="#">T-878/16</a>, KARELIA,</p> <p>EU:T:2017:702</p>
--	--	---

2. **A reasonable assumption can be made** that a place will be associated with those goods or services in the future or that a name may, in the mind of the relevant public, designate the geographical origin of that category of goods or services.

In establishing whether the abovementioned assumption can reasonably be made, the following circumstances should be considered:

- There are some geographical terms, such as the names of regions or countries, that enjoy widespread recognition and fame for the high quality of their goods and/or services. **When a sign consists of such geographical terms**, there is no need for a detailed assessment of the association between **the place and each** (category) of the goods and/or services. Such signs may be refused on the basis of being perceived as a reference to the quality of the goods and/or services, namely that linked with the geographical term (15/12/2011, [T-377/09](#), Passionately Swiss, EU:T:2011:753, § 43-45).
- Nature and size of the geographical location in question. There is generally a correlation between geographical size, variety of goods and/or services made available in the place concerned and corresponding knowledge or expectations on the part of consumers. In that regard, it is assumed that the name of a country will, in principle, be associated with the relevant goods and/or services and that the public will accordingly perceive a country name as an indication of the geographical origin of the goods and/or services. This assumption, however, does not automatically rule out the need for an assessment of whether or not the public actually establishes such a descriptive link between the sign and the goods and/or services. Moreover, in line with the nature of the location, its

characteristics should be taken into account. Characteristics such as natural conditions, industries typical to the geographical location or a tradition of manufacturing the goods in question are important factors to be taken into account. The mere fact that some production of the relevant goods or provision of the relevant services is located in the geographical place in question is not per se sufficient to support the abovementioned assumption.

- Market sectors. It must be borne in mind that, in certain market sectors, such as the car or furniture industries, it is common to use place names without a real geographical connotation, for example to designate models or range of products.

It is **not necessary** to establish that the name actually designates the **true** geographical origin of the goods. It is enough to demonstrate that the connection between the name of the place and the goods may enable the relevant public to perceive the contested sign as an indication of the origin of those goods (15/10/2003, [T-295/01](#), Oldenburger, EU:T:2003:267, § 43).

A refusal on the grounds of Article 7(1)(c) EUTMR cannot be based solely on the argument that the goods and/or services can **theoretically** be produced or rendered in the place designated by the geographical term (08/07/2009, [T-226/08](#), Alaska, EU:T:2009:257).

Consequently, if it can be concluded that there is a particular relationship between the geographical place designated by the sign and the goods and/or services for which the protection is sought, the Office will raise an objection.

Sign	Reasoning	Case No
<p>MIAMI</p> <p>Class 25: <i>Track pants, tracksuits</i></p>	<p>Miami is a large city attracting a large number of tourists (para 24).</p> <p>Unlike indications of a country of production, it is unusual to refer to a city as a place of production for clothing. The consumer knows that clothing can be produced in any number of places, including under the same mark, and indeed not necessarily at the place where the trade mark proprietor is based, but mostly in low-wage countries. Where production takes place within the EU, it is the country concerned that is normally indicated and not a particular city. As the contested decision correctly points out, this would only be different in the case of cities that the consumer currently associates with fashion, or at least as locations for fashion design, such as Paris. This too would have to be proven, because fashion design is also generally possible anywhere in the world (para 27).</p> <p>Furthermore, there are no apparent reasons as to why consumers in the EU would associate the city of Miami, of all places, with tracksuits. There is no particular relationship between the geographical or climatic characteristics of the city of Miami or of the US State of Florida (including its beaches) and the nature of tracksuits.</p>	<p>08/06/2018,  <a href="#">R 2528/2017-4</a>, MIAMI</p>

The mere fact that a geographical term is used by only one producer is not sufficient to overcome an objection, although it is an important argument to be taken into account in assessing acquired distinctiveness.

The following marks were refused:

Sign	Reasoning	Case No
<p>BRASIL</p> <p><i>Class 32: Beers; Mineral and aerated waters and other non-alcoholic beverages; Fruit beverages and fruit juices; Syrups and other preparations for making beverages.</i></p> <p><i>Class 33: Whisky; whisky-based beverages.</i></p>	<p>The Board recognised that the mere existence of whisky production in Brazil was not sufficient in itself to presume that the relevant consumer of whisky will associate the sign with the goods. However, it had to be assessed whether it was reasonable to assume that such an association might be established in the future. The BoA assessed a number of factors, including the fact that it is current practice in trade to indicate the geographical origin of whiskies and whisky-based beverages. It concluded that the designation 'Brasil' would be understood as an informative indication for whisky and whisky-based beverages (para. 29).</p>	<p>06/02/2014,  <a href="#">R 434/2013-1</a>,            Brasil</p>
<p>SUEDTIROL</p> <p><i>Class 35: Business management; business administration; office functions.</i></p> <p><i>Class 39: Packaging and storage of goods.</i></p> <p><i>Class 42: Scientific and technological services and research and design relating thereto; industrial analysis and research; design and development of computer hardware and software; legal services.</i></p>	<p>The Court considered that the Grand Board of Appeal was correct to find that services such as those designated by the contested mark are in principle offered in every region of a certain level of economic importance (para. 41).</p> <p>In addition, it is true that the relevant public might take the contested mark as a reference to a specific quality of the services in question, for example, to the fact that the services are tailored to the particular requirements of businesses operating in that region, characterised by a particular political, administrative and linguistic context. Thus, the use of a geographical indication of origin is likely to convey to those concerned a positive idea or image of a particular quality of those services, within the meaning of the case-law (para. 42).</p>	<p>20/07/2016,  <a href="#">T-11/15</a>,            SUEDTIROL,            EU:T:2016:422</p>
<p>VIRO</p> <p>Classes 9 and 11</p>	<p>The sign 'VIRO' is perceived by the relevant Finnish-speaking consumers as the name of Estonia. It therefore designates, in the perception of the relevant public, a geographical place, which was already known to this public due to its size, economic significance and cultural tradition long before the filing of the mark (para. 24).</p>	<p>28/03/2017,  <a href="#">R 2312/2016-1</a>,            Viro</p>

Sign	Reasoning	Case No
<p>AUSTRALIA</p> <p>Classes 12, 25, 28, 35 and 37</p>	<p>It is a well-known fact that Australia is a strong economic nation with a thriving economy, which has grown steadily for more than a quarter of a century. Due to its size, its political and economic importance and its popularity as a holiday destination, Australia has a strong reputation in the EU and its Member States (para. 21).</p> <p>First, with regard to all the goods and services for which protection is sought, the contested trade mark is understood as a reference to a positive image, namely a particular attitude towards life. Australia is widely associated with a sense of freedom, wide open spaces and a connection with nature, of which the Australian Outback is representative. Consequently, it is likely that the geographical name 'AUSTRALIA' will influence consumers in the choice of their goods and services, as they associate the goods and services thus marked with this particular attitude to life, which triggers a positive reaction (06/02/2014, <a href="#">R 434/2013-1</a>, BRASIL, § 32). The sign applied for is descriptive, as it indicates that the use or take-up of the goods and services in question contributes to creating a particular attitude to life linked to Australia (para. 26).</p>	<p>06/04/2018, <a href="#">R 2207/2017-2</a>, AUSTRALIA</p>
<p>MONACO</p>	<p>The Court found that the word 'monaco' corresponded to the name of a principality known throughout the world, not least because of the renown of its royal family and its organisation of a Formula 1 Grand Prix and a circus festival. The Court considered that the trade mark MONACO had to be refused for goods and services in Classes 9, 16, 39, 41 and 43 as the word 'monaco' could be used, in trade, to designate origin, geographical destination or the place of supply of services. The trade mark was thus descriptive for the goods and services concerned.</p>	<p>15/01/2015, <a href="#">T-197/13</a>, MONACO, EU:T:2015:16</p>

Sign	Reasoning	Case No
Passionately Swiss	The Court held that BoA did not need to go into a detailed assessment of the association between the sign and each of the goods and services. It based its finding on Switzerland's reputation for quality, exclusiveness and comfort, which can be associated with the services in Classes 35, 41, 43 and 44 and the goods in Class 16 (para. 45).	15/12/2011, <a href="#">T-377/09</a> , Passionately Swiss, EU:T:2011:753
PARIS	BoA established that 'PARIS' is likely to be associated with a certain idea of quality, design, stylishness and even of being avant-garde. This results in a positive feeling, an expectation with regard to the quality of the goods sold and the services provided, when 'PARIS' is put forward as an indication of geographical origin or destination.	26/10/2015, <a href="#">R 3265/2014-4</a> , Paris

The following marks were registered:

- HOLLYWOOD for goods in Class 30 (EUTM No 31 450)
- GREENLAND for fresh fruits and vegetables (30/09/2002, [R 691/2000-1](#), Greenland)
- DENVER for lighting equipment (03/04/2013, [R 2607/2011-2](#), DENVER)
- PORT LOUIS in Classes 18, 24 and 25 (15/10/2008, [T-230/06](#), Port Louis, EU:T:2008:443).

## 2.7 Terms describing subject matter in goods or services

### 2.7.1 General considerations

Where a sign consists exclusively of a word that describes what may be the subject matter or content of the goods or services in question, it should be objected to under [Article 7\(1\)\(c\) EUTMR](#). Commonly known terms likely to be linked to a particular thing, product or activity by the relevant public are capable of describing subject matter and should therefore be kept free for other traders (12/06/2007, [T-339/05](#), Lokthread, EU:T:2007:172, § 27).

The essential question is whether the sign applied for **may be used in trade in relation to the goods or services applied for** in a manner that will be undoubtedly perceived by the relevant public as descriptive of the subject matter of those goods or services for which protection is sought, and should therefore be kept free for other traders.

For example, a widely known name such as 'Vivaldi' will immediately create a link to the famous composer, just as the term 'skis' will immediately create a link to the sport

of skiing. While Class 16 (books) is a prime example of a category of goods that contains subject matter or content, an objection made under this section may occur also with respect to other goods and services, such as *DVDs* (a term that includes not only blank DVDs but also recorded DVDs) or editorial services. With regard to this section, the terms ‘subject matter’ and ‘content’ are used interchangeably.

Names of famous persons (in particular musicians or composers) can indicate the category of goods, if due to widespread use, time lapse, date of death, popularisation, recognition, multiple performers or musical training, the public can understand them as generic. This would be the case, for example, with respect to ‘Vivaldi’, whose music is played by orchestras all over the world and the sign ‘Vivaldi’ will not be understood as an indicator of origin for music.

With regard specifically to famous titles of books, see below [2.7.2 titles of books](#).

In the event of services, where a sign consists of a term indicating a certain industry, such as ‘CLOTHING’ or ‘CARS’, and it can be reasonably assumed that a services provider (e.g. in the field of advertising or retail services) could specialise to meet the characteristics of that particular industry, an objection to subject matter should be raised.

Objections based on the above:

- will apply only to goods (e.g. *books*) or services (e.g. *education*) that contain subject matter regarding other things, products and/or activities (e.g. a book about history, or an educational course on history);
- when the sign consists exclusively of the word identifying that subject matter (e.g. ‘VEHICLES’ or ‘HISTORY’); and
- will be made on a case-by-case basis by assessing multiple factors, such as the relevant public, the degree of attention or the descriptive character of the term in question, or the market reality (see below).

#### Goods and services that may contain subject matter

For most cases, the goods or services that may consist of or contain subject matter that give rise to an objection are the following.

- Class 9: *software, electronic publications (downloadable)*.
  - Give rise to an objection
- STATISTICAL ANALYSIS for software
- ROCK MUSIC for CDs (a term that includes not only *blank CDs* but also *recorded CDs*).
- Class 16: *Printed matter, photographs and teaching materials as long as these include printed matter*.
  - Give rise to an objection
- HISTORY for books
- PARIS for travel guides
- CAR for magazines

- ANIMALS for photographs
- TRANSCENDENTAL MEDITATION for *instructional and teaching material*.
- Class 28: *Board games*
  - Give rise to an objection
- ‘Memory’ (14/03/2011, [C-369/10 P](#), Memory, EU:C:2011:148).
- Class 35: *Trade fairs, advertising, retail services, import-export services*.
  - Give rise to an objection
- ELECTRONICA for trade fairs related to electronic goods (05/12/2000, [T-32/00](#), Electronica, EU:T:2000:283, § 42-44)
- LIVE CONCERT for advertising services
- CLOTHING for retail services
- PHARMACEUTICALS for import-export services.
- Class 41: *Education, training, entertainment, electronic publications (non-downloadable)*.
  - Give rise to an objection
- GERMAN for language courses
- HISTORY for education
- COMEDY for television programmes
- TRANSCENDENTAL MEDITATION for *education services*.

**The above list of Nice classes is not exhaustive, although it will apply to the vast majority of cases.** Consequently, objections based on descriptive subject matter should be raised primarily in the context of the goods and services listed above.

Where the sign applied for is a descriptive term for a particular characteristic of goods or services, a designation of goods or services that excludes that particular characteristic described by the sign applied for will not avoid an objection based on subject matter. This is because it is unacceptable for an applicant to make a claim of goods or services subject to the condition that they do not possess a particular characteristic (12/02/2004, [C-363/99](#), Postkantoor, EU:C:2004:86, § 114-116). The following invented examples illustrate designations of goods or services that will not avoid an objection:

- COMEDY for television broadcasting, except for comedy *programming*
- PENGUINS (in plural!) for books, except for books about *penguins*
- TECHNOLOGY for classes, except for classes about computers and *technology*.

Distinguishable from the examples above are positive claims of goods or services, under which it is impossible for the sign applied for to describe any subject matter or content. For example, the following invented examples would not be liable to objection, at least with regard to signs being descriptive of subject matter:

- COMEDY for television broadcasting of economic news, politics and *technology*



- PENGUIN for comic books with country western, medieval and ancient Roman *themes*
- TECHNOLOGY for classes about creative fiction *writing*.

### 2.7.2 Titles of books

The fact that a sign applied for is the title of a book is not per se an obstacle for registration as a trade mark. However, the Office will refuse the mark when it can be perceived as describing the subject matter of the goods and services and thus has not the capacity to identify the commercial origin of the goods or services.

Trade marks consisting solely of a book title may be descriptive under [Article 7\(1\)\(c\) EUTMR](#) in relation to goods and services that could be perceived as containing or dealing with the well-known story, a new version of it or a theme linked to the story. The reason for this is that certain stories (or their titles) have been established for so long and become so well known that they have ‘entered into the language’. They are no longer linked exclusively with the original book, but have rather become well known, universal and autonomous commonplace expressions to denote a certain type of story or an entire genre.

For example, ‘The Jungle Book’ or ‘Robinson Crusoe’ are book titles originally attributable to a particular literary work and a particular author (Rudyard Kipling; Daniel Defoe). Due to the enormous popularity of the books, and facilitated by the passing of time, their titles have, in the public’s perception, gradually gained a thematic significance, which extends beyond the actual content of the books concerned. They have entered into everyday language as synonyms for a particular type of story or genre (e.g. young humans succeeding on their own in the wilderness; struggle against nature, hardship, privation, loneliness).

While such famous book titles might remain perfectly capable of being distinctive for paint, clothing or pencils, they will become incapable of performing a distinctive role in relation to goods and services that could merely have the general story or genre as their content (e.g. publications, data carriers or cultural events).

The assessment of whether a book title has reached a sufficient degree of recognition depends on a thorough case-by-case analysis, taking account of the particularities of the individual case.

The following, non-exhaustive considerations might assist in evaluating whether the title of a book would be perceived as descriptive of the subject matter of the goods and services and thus not capable of denoting the commercial origin of subject-related goods and services.

- **Adaptations**

A finding of non-distinctiveness will be more likely where it can be shown that a large number of published versions of the story have appeared and/or where there have been numerous television, theatre and film adaptations reaching a wide audience.

- **Cultural Heritage**

The fact that a book or its story is included in a high-profile encyclopaedia, that it frequently forms part of school/university curricula and that it is subject to ample scientific research and abstract analysis of its main themes might be an indicator that it is considered a ‘Classic’, that is to say, a book that has reached a universal importance that stretches beyond its actual content and that actively forms part of the cultural DNA of the general public (e.g. ‘The Odyssey’, ‘Cinderella’, ‘Romeo and Juliet’, ‘Don Quixote’).

- **Time**

The more time has passed by since the publication of the original work, the more likely it becomes that a book’s plot, its characters and its title are no longer strictly connected to a particular author or the exact story, but have rather reached a status of autonomy.

Depending on the mark in question, an objection may be taken in relation to printed matter, films, recordings, plays and shows (this is not an exhaustive list).

Examples for book titles considered to be descriptive of the subject matter:

‘**Pinocchio**’ ([R 1856/2013-2](#)): partly declared invalid for Classes 9, 16, 28, 41;

‘**The Jungle Book**’ ([R 118/2014-1](#)): partly rejected for Classes 9, 16, 41;

‘**Winnetou**’ ([R 1297/2016-2](#)): partly declared invalid for Classes 9, 16, 28, 41.

Examples for book titles considered to be sufficiently distinctive:

‘**Die Wanderhure**’ (EUTM No 12 917 621): in Classes 9, 16, 35, 38 and 41;

‘**Partners in crime**’ (EUTM No 13 011 887): in Classes 9, 16 and 41.

## 2.8 Single letters and numerals

### Single letters <sup>(15)</sup>

#### *General considerations*

In its judgment of 09/09/2010, [C-265/09 P](#),  $\alpha$ , EU:C:2010:508, the Court stated that when examining absolute grounds for refusal, the Office is required, under [Article 95\(1\) EUTMR](#), to examine, of its own motion, the relevant facts that might lead it to raise an objection under [Article 7\(1\) EUTMR](#) and that that requirement cannot be made relative or reversed, to the detriment of the EUTM applicant (paras 55-58). Therefore, it is for the Office to explain, with motivated reasoning, why a trade mark consisting of a single letter represented in standard characters is descriptive.

Consequently, when examining single letter trade marks, generic, unsubstantiated arguments such as those relating to the availability of signs, given the limited number of letters, should be avoided. Similarly, it would not be appropriate to base an objection on speculative reasoning as to the different meanings that a sign could possibly have.

---

<sup>15</sup> This part deals with single letters under [Article 7\(1\)\(c\) EUTMR](#). For single letters under [Article 7\(1\)\(b\) EUTMR](#), see the [Guidelines, Part B, Examination, Section 4, Absolute Grounds for Refusal, Chapter 3, Non-Distinctive Trade Marks \(Article 7\(1\)\(b\) EUTMR\), paragraph 5](#).

The Office is obliged to establish, **on the basis of a factual assessment**, why the trade mark applied for would be liable to objection.

It is therefore clear that the examination of single letter trade marks should be thorough and stringent, and that each case calls for a careful examination.

#### *Examples*

For instance, in **technical domains** such as those involving computers, machines, motors and tools, it may be that particular letters have a descriptive connotation if they convey sufficiently precise information about the goods and/or services concerned.

The **letter ‘E’** was also considered to be descriptive in respect of *wind power plants and parts thereof, generators, rotor blades for wind power plants, rotors for wind power plants* in Class 7, *control switches for wind power plants, frequency converters, measuring, signalling and checking (supervision) instruments, apparatus and instruments for conducting, switching, transforming, accumulating, regulating or controlling electricity* in Class 9 and *towers for wind power plants* in Class 19, since it may be seen as a reference to energy or electricity (21/05/2008, [T-329/06](#), E, EU:T:2008:161, § 24-31; 08/09/2006, [R 394/2006-1](#), E, § 22-26; 09/02/2015, [R 1636/2014-2](#), E (fig.)).

An objection might also be justified in respect of goods and/or services meant for a wider public. For example, **the letters ‘S’, ‘M’ or ‘L’** for clothing would give rise to an objection as these letters are used to describe a particular size of clothing, namely as abbreviations for ‘Small’, ‘Medium’ or ‘Large’.

However, if it cannot be established that a given single letter is descriptive for the goods and/or services concerned, and provided that the trade mark applied for is not open to objection under another provision of [Article 7\(1\) EUTMR](#), then the application should be **accepted**.

See the Guidelines, [Part B, Examination, Section 4, Absolute Grounds for Refusal, Chapter 3, Non-Distinctive Trade Marks \(Article 7\(1\)\(b\) EUTMR\), paragraph 5.2](#) for further examples of where an objection under [Article 7\(1\)\(b\) EUTMR](#) may be raised.

#### Numerals

In its judgment of 10/03/2011, [C-51/10 P](#), 1000, EU:C:2011:139, the Court of Justice ruled that signs composed exclusively of numerals with no graphic modifications may be registered as trade marks (paras 29-30).

The Court referred by analogy to its previous judgment of 09/09/2010, [C-265/09 P](#), α, EU:C:2010:508, in respect of single letters (para. 31) and emphasised that trade marks consisting of numerals must be examined with specific reference to the goods and/or services concerned (para. 32).

Therefore, a numeral may be registered as a European Union trade mark only if it is distinctive for the goods and services covered by the application for registration (para. 32) and is not merely descriptive or otherwise non-distinctive for those goods and services.

For example, the Boards of Appeal confirmed the refusal of the trade marks '15' (12/05/2009, [R 72/2009-2](#), 15) and '60' (23/09/2015, [R 553/2015-4](#), 60) applied for in respect of 'clothing, footwear, headgear' in Class 25. The board considered in the first case that that the numeral '15' is linked directly and specifically to these goods, as it contains obvious and direct information regarding their size (paras 15-22). In the second decision, it held that the indication of size 60, whether it exists or might exist, would naturally be understood and connected to measurement (size) by the relevant public (para. 19).

The Board also confirmed the refusal of the sign '15' for 'beers' in Class 32, as practical experience of the marketing of the relevant goods — relied upon by the Office — showed that a number of very strong beers with an alcohol content of 15 % volume exist on the EU market (12/05/2009, [R 72/2009-2](#), 15, § 15-22).

It is well known that numerals are often used to convey relevant information as to the goods and/or services concerned. For example, in the following scenarios an objection would apply on the ground that the sign applied for is descriptive since it refers to:

- the **date** of production of goods/provision of services, when this factor is relevant in respect of the goods/services concerned. For instance, 1996 or 2000 for *wines* would give rise to an objection, since the age of the wine is a very relevant factor when it comes to the purchasing choice; 2020 would give rise to an objection also for *events* as it could be considered the year of an event;
- **size**: in addition to the previous examples 15 and 60 for clothing, 1 600 for cars, 185/65 for tyres, 10 for women's clothing in the UK, 32 for women's clothing in France;
- **quantity**: 200 for cigarettes;
- **telephone codes**: 0800 or 0500 in the UK, 800 in Italy, 902 in Spain, etc.;
- the **time** of provision of services: 24/7;
- the **power** of goods: 115 for engines or cars;
- **alcoholic content**: 4.5 for lager, 13 for wines;
- the **number of pieces**: 1 000 for puzzles.

However, where the numeral does not appear to have any possible meaning for the goods and services, it is acceptable, that is to say, '77' for *financial services* or '333' for *clothing*.

## 2.9 Names of colours

Name of colours can be **single colour** names (e.g. red, green), **compound colour** names (e.g. navy blue, blood red) or more **unusual** colour names. Among unusual colour names, there are names of objects, gemstones, flowers or similar elements (e.g. magnolia, emerald, amethyst, alabaster) and combination of colour associated with another noun (e.g. flamenco red, crystal pink, vintage rose, Bermuda blue).

A sign consisting exclusively of the name of a colour must be objected to under [Article 7\(1\)\(c\) EUTMR](#) when the application claims any **goods and services for which the colour constitutes an objective characteristic, inherent to the nature of that**

**product or service and intrinsic and permanent with regard to that product or service** (07/05/2019, [T-423/18](#), *vita*, EU:T:2019:291, § 44). For the ground of refusal to apply, a direct and specific link is necessary in the mind of the relevant public, not just an indirect association (07/05/2019, [T-423/18](#), *vita*, EU:T:2019:291, § 52).

In the ‘vita’ case (‘vita’ being the Swedish term for ‘white’), the GC held that the colour white did not constitute an ‘intrinsic characteristic’ which is ‘inherent to the nature’ of goods like food processors, electric pressure cookers and household utensils, but a purely random and incidental aspect which only some of them may have and which does not, in any event, have any direct and immediate link with their nature. Since the relevant goods are available in a multitude of colours, the mere fact that they are more or less usually available in white, among other colours, is irrelevant, since it is not ‘reasonable’ within the meaning of the case-law to believe that for that reason alone the colour white will actually be recognised by the relevant public as a description of an intrinsic characteristic which is inherent to the nature of those goods.

As a consequence, the name of the colour BLUE would be objected to in relation to cheese, as it describes a specific kind of cheese. GREEN describes a specific kind of tea or environmentally friendly services, while BROWN in relation to sugar describes the colour and kind of sugar.

When the goods for which protection is sought **concern colourants such as paint, ink, dyes or cosmetics** (e.g. lipsticks or make-up), the name of a colour may describe the actual colour of the goods, and signs consisting exclusively of a colour name should be objected to under [Article 7\(1\)\(c\) EUTMR](#), as the names of colours would not be seen as trade marks but merely as indications of the principal characteristic of the goods.

#### *Accepted trade marks*

Sign	Reasoning	Case No
------	-----------	---------

<p style="text-align: center;"><b>RED</b></p> <p>EUTM No 14 654 842 registered for goods in Classes 6-9, 11,17 and 19</p>	<p>The sole fact that the goods claimed can be offered in red does not mean that 'RED' is understood as descriptive by the consumer. Colours play no role as product characteristics in the sector of the goods in question (i.e. <i>common metals and their alloys</i> (Class 6) or <i>rubber, asbestos, mica and goods made of these materials</i> (Class 17)). But even if goods like cables, wires, machines, tools, weapons, razors, household appliances, pipes, etc. may have a colour, this colour does not describe an essential characteristic of those goods. Therefore, the use of the indication 'RED' in connection with the goods claimed does not lead to the conclusion that the targeted consumers will automatically perceive the sign as a descriptive characteristic.</p>	<p>Decision of the Fourth Board of Appeal of 7 November 2019, <a href="#">R 1246/2019-4</a>, § 14</p>
---	--	---

*Rejected trade marks*

Sign	Reasoning	Case No
<p>VISIBLE WHITE</p> <p>EUTM No 802 793</p> <p>Rejected for <i>toothpaste and mouthwash</i></p>	<p>The terms 'visible' and 'white' allow the relevant public to detect immediately and without further reflection the description of a fundamental characteristic of <i>toothpaste and mouthwash</i>, in the sense that their use makes the white colour of teeth visible. 'Visible white' describes an intrinsic characteristic that is inherent to the nature of the goods concerned, namely the reason to use them or their intended purpose.</p>	<p>09/12/2008, <a href="#">T-136/07</a>, Visible White), EU:T:2008:553, § 42, 43.</p>
<p>TRUEWHITE</p> <p>EUTM No 8 272 321</p> <p>Rejected</p> <p>for <i>light emitting diodes (LED)</i>.</p>	<p>The term 'truewhite', applied to light-emitting diodes (LED) merely described an essential characteristic of those goods, namely their ability to reproduce light of such whiteness that could be considered to be similar to natural light. In that case, the term 'true white' also described an intrinsic characteristic inherent to the nature of the goods concerned, namely their quality.</p>	<p>07/07/2011, <a href="#">T-208/10</a>, TRUEWHITE, EU:T:2011:340, § 23</p>

## 2.10 Names of banks, newspapers/magazines and airports

In some fields, such as banks, newspapers, magazines and airports, consumers are accustomed to recognising descriptive combinations of terms as badges of origin.

This is due to the market reality whereby a sign composed of different elements has the capacity to **identify a specific entity**. It is the case, for example, of a sign that describes an entity that is the only one to offer the respective goods and/or services.

The following marks were **accepted**.

Sign	EUTM No
BANK OF ENGLAND Classes 6,8,9,14,16,18,21,28,30,35,36,41, 42, 45	11 157 641

Sign	EUTM No
DIARIO DE LAS PROVINCIAS DE VALENCIA Classes 16, 35	54 619

Sign	EUTM No
AEROPORT TOULOUSE-BLAGNAC Classes 16,35,36,37,38,39,41,42,43,45	13 952 346

Nevertheless, descriptive combinations give rise to an objection when they do not create, at least prima facie, the impression of a clearly identifiable entity. It is the case when the sign refers to a general category and not a specific unique entity.

The following marks were refused.

Sign	Reasoning	EUTM No
CHARITY BANK Classes 9, 35 and 36	The sign as a whole merely indicates that the goods and services are provided by a bank that focuses on charity more than other banks that may also support charity activities.	4 454 872



Sign	Reasoning	EUTM No
European PrivateTrust BANK Class 36	The expression taken as a whole immediately informs consumers without further reflection that the services applied for are insurances, financial and monetary services, etc., that are rendered by a European non-public trust bank that is organised to perform the fiduciary of trusts and agencies.	11 585 908

Sign	Reasoning	EUTM No
JOURNAL OF OPTOMETRY Classes 16 and 41	The relevant consumer will not see the sign as something unusual but rather as a meaningful expression: a publication related to the world of optometry with its technological projection and the knowledge of the mentioned science.	6 646 996
HEALTH JOURNAL Classes 16 and 38	The consumers will see the sign as an indication of the good itself.	1 524 396

Sign	Reasoning	EUTM No
<b>ALICANTE-AIRPORT</b> Class 35	The expression is not the official denomination of the main airport next to the city of Alicante. The expression 'alicante-airport' immediately informs consumers without further reflection that the services applied for are from an airport in the city or province of Alicante. Therefore, the mark conveys obvious and direct information regarding the geographical origin of rendering of the services in question.	15 140 676

## 2.11 Names of hotels

In the hotel sector, hotel names are often the combination of the word 'HOTEL' together with a geographical term (i.e. the name of an island, a city, a country etc.). They usually indicate specific establishments that **do not have any link with the geographical term they refer to**, since they are not situated in that specific location. Consequently, due to these trade habits, consumers would not perceive expressions such as 'HOTEL BALI', 'HOTEL BENIDORM' or 'HOTEL INGLATERRA' as descriptive indications (describing that the services are provided by a hotel that is situated in that specific location) but rather as badges of origin.

Indeed, such expressions are not equivalent to the grammatically correct ones 'HOTEL IN BALI', 'HOTEL DE BENIDORM' or 'HOTEL EN INGLATERRA', which clearly give rise to an objection. This is even truer in cases where the hotel name consists of the names of two different cities, (or of two geographical terms in general), for example 'HOTEL LONDRES SAN SEBASTIAN'. Indeed, in this case the presence of the wording SAN SEBASTIAN (a city in the north of Spain) clearly indicates that 'HOTEL LONDRES' must be regarded as a fanciful expression. Therefore, no objection should be raised.

Nevertheless, in those **cases where the geographical term precedes the word 'HOTEL', the situation may change according to the different languages**. For example, in English the wording 'BALI HOTEL', would be perceived as an expression merely indicating any hotel located in the island of Bali, which clearly gives rise to an objection. Consequently, each case should be assessed on its own merits. Finally, descriptive combinations such as 'LEADING HOTELS' give rise to an objection since they do not create, at least prima facie, the impression of a clearly identifiable entity.

## 2.12 Combinations of names of countries/cities with a number indicating a year

Marks consisting of the combination of the name of a country/city with a number indicating a year must be refused under [Article 7\(1\)\(b\) and \(c\) EUTMR](#) in the following cases.

Firstly, where the combination is perceived by the relevant consumers as **describing an event** happening that specific year in the designated geographic location, it must be **refused for all the goods and services** for which protection is sought, since it is considered that the descriptive link applies to any good or service.

As an **example**, the mark ‘GERMANY 2006’ was found to be immediately perceived as a reference to an event that would take place in 2006. It has been considered as a descriptive indication for a wide list of goods and services, ranging from *unexposed films* in Class 1 to *vehicle maintenance* in Class 37. In particular, the decision of 30/06/2008 in case [R 1467/2005-1](#) stated that this mark:

- is descriptive of the kind and content of those services ‘of actually preparing, organising and promoting an event in Germany in 2006’ (para. 29, referring to the organisation of sporting events related to or associated with football championships, etc.);
- is descriptive of ‘the purpose and thereby in part the level of quality of goods or services, during such competitions in Germany in the year 2006, as being suitable for competitions of the highest standard or that it has been successfully used in the context of such competitions’ (para. 30, referring to medical instruments, soccer balls, etc.);
- qualifies the goods as souvenir articles (para. 31, referring to goods such as stickers, confetti, pyjamas, etc.).

With regard to **souvenir articles**, the Board underlined that ‘merchandising and co-branding is not limited to ‘classic’ souvenir products. It is public knowledge that there is a tendency to try to find new markets by combining various goods with the brand of some other unrelated popular event or names’ (30/06/2008, [R 1467/2005-1](#), GERMANY 2006, § 34, referring to goods such as eyeglasses, televisions, toilet paper, etc., all related to or associated with football championships). In line with the above, the Boards confirmed the refusal of the trade mark ‘TARRAGONA 2017’ for various commemorative articles, such as goods in Class 6 (*bronzes (works of art), busts of common metal, crates of metal, bells, placards of metal*, etc.) or goods in Class 14 (*jewellery ornaments, decorative pins of precious metal, amulets (jewellery), rings (jewellery), bracelets and wrist bands*, etc.) (28/10/2016, [R 2318/2015-5](#), TARRAGONA 2017, § 32).

Secondly, where the combination is not, or not any more, perceived by the relevant consumers as describing an event that happens, or took place, in that specific year in the designated geographic location, a sign combining the name of a country or city with a number indicating a year might still be perceived by the relevant public as an indication of another characteristic, such as the place and time of production or

destination. The assessment has to be made in accordance with the criteria explained under [paragraph 2.6](#) above.

## 2.13 INN codes

**International non-proprietary names (INNs)** are assigned to pharmaceutical substances by the World Health Organisation (WHO), so that each substance can be recognised by a unique name. These names are needed for the clear identification, safe prescription and dispensing of medicines, and for communication and exchange of information among health professionals. INNs can be used freely because they are in the public domain. Examples of INNs are alfacalcido, calcifediol, calcipotriol.

**Stems** define the pharmacologically related group to which the INN belongs. INN stems serve to indicate the mode of action of groups of drugs. These stems and their definitions have been selected by WHO experts and are used when selecting new international non-proprietary names. An example of a stem is ‘calci’.

The criteria for assessing the descriptiveness of a trade mark for pharmaceuticals are no different from those applicable to other categories of trade marks. The provisions of trade mark law apply to pharmaceuticals in the same way as to other categories of goods. The European Medicines Agency (EMA) assesses the single name under which a medicinal product will be marketed as part of its marketing authorisation for the European Union. The EMA’s assessment is based on public health concerns and takes into account the WHO World Health Assembly resolution (WHA46.19) on protection of INNs/INN stems to prevent any potential risk of confusion. The Office’s assessment of the registrability of pharmaceutical trade marks, however, has no specific legal basis for taking such health-related concerns into consideration (by analogy, 05/04/2006, [T-202/04](#), Echinaid, EU:T:2006:106, § 31-32).

Considering the descriptive nature of INN codes and stems, an objection should be raised for Class 5 in the following scenarios:

- where the EUTM is an INN (the general rules on misspellings also apply, see [paragraph 2.3](#) above); or
- where an INN appears within an EUTM and the other elements of the EUTM are descriptive/non-distinctive too (for instance BIO, PHARMA, CARDIO, MED, DERMA); or
- where the EUTM consists **only** of a stem.

A list of INN codes can be accessed after online registration on MedNet (<https://mednet-communities.net>). A list of common stems is available at the following link: [INN Stem Book 2018 \(who.int\)](#) .



Office practice is to accept figurative trade marks containing INN codes or stems, applying the same criteria as to any other figurative trade mark containing descriptive word elements (i.e. whether the stylisation and/or the graphical features of a sign are sufficient for it to act as a trade mark).

An objection may also be based on [Article 7\(1\)\(g\) EUTMR](#) in the unlikely scenario that the list of goods in Class 5 refers to a different kind of drug from that covered by the INN. Where the list in Class 5 includes *pharmaceuticals*, the Office assumes good faith and no objection under [Article 7\(1\)\(g\) EUTMR](#) will be raised.

### 3 Figurative Marks

By definition ([Article 3\(3\)\(b\) EUTMR](#)), marks where **non-standard characters, stylisation or layout**, or a graphic feature or a colour is used are figurative marks. Signs represented in alphabets other than Latin, Greek or Cyrillic are to be considered figurative trade marks. However, this does not mean that the semantic content of these signs will not be taken into consideration for the purpose of the application of [Article 7\(1\)\(c\) EUTMR](#).

Where a figurative mark consists exclusively of a basic natural form that is not significantly different from a true-to-life portrayal that serves to indicate the kind, intended purpose or other characteristic of the goods or services, it should be objected to under [Article 7\(1\)\(c\) EUTMR](#) as descriptive of a characteristic of the goods or services in question.

Sign	Case No
	08/07/2010, <a href="#">T-385/08</a> , Hund, EU:T:2010:295
	08/07/2010, <a href="#">T-386/08</a> , Pferd, EU:T:2010:296

In these cases, the Court held that for goods in Classes 18 and 31, the depiction of a dog or horse, respectively, serves to indicate the type of animal for which the goods are intended.

In the first case, the Court noted that the goods in Class 18 were specially produced for dogs, such as dog leads, dog collars and other dog accessories including bags. In the field of animal accessories, it is common practice for true-to-life or stylised but realistic portrayals of animals to be used for indicating the type of animal concerned. Therefore, for the goods in Class 18, the relevant public will immediately perceive the image's message that those goods are for dogs, without any further mental steps. The portrayal of a dog, therefore, indicates an essential characteristic of the goods concerned. The sign applied for is, therefore, descriptive (paras 25-28).

The same applies to goods in Class 31. As foodstuffs for domestic animals include dog food, the mark applied for is a descriptive indication for the goods at issue that will be immediately understood by the relevant public (para. 29).

In the second case, the Court held that for *clothing, headgear and belts* in Class 25, the portrayal of a horse was descriptive of the kind or intended purpose of the goods, namely that they are particularly developed or suitable for horse riding. As the relevant public would make a direct link between a horse and horse riding, the Court maintained that there was an immediate and concrete link between the portrayal of a horse and the goods concerned (paras 35-38).

Sign	Case No
 <p>Classes 5, 25 and 35</p>	<p>29/09/2016, <a href="#">T-335/15</a>,            DEVICE OF A BODY BUILDER (fig.),            EU:T:2016:579</p>

The Court noted that the image in question represents in a fairly realistic way the silhouette of a bodybuilder in a typical pose that highlights the body's muscles and, in particular, those of the arms. No detail or characteristic of that image goes beyond the standard representation of a bodybuilder. The mark applied for shows a sufficiently direct and specific relationship to the goods and services covered by the application for registration, enabling the relevant public to perceive immediately the nature and intended purpose of those goods and services.

By way of example, the sign below was held to be sufficiently highly stylised to significantly differ from a true-to-life portrayal serving to indicate the kind or intended purpose of the goods or services, and, thus, was registered.

Sign	EUTM No	Goods and services
	<p>844</p>	<p>Classes 1, 3, 5, 6, 7, 8, 9, 11, 16,            17, 18, 19, 20, 21, 22, 26, 28, 31,            41, 42</p>

## 4 Figurative Threshold

### 4.1 Preliminary remarks

Terms or signs that are non-distinctive, descriptive or generic may be brought out of the scope of a refusal based on [Article 7\(1\)\(b\), \(c\) or \(d\) EUTMR](#) if combined with other elements that make the sign as a whole distinctive. In other words, refusals based on [Article 7\(1\)\(b\), \(c\) and/or \(d\) EUTMR](#) may not apply to signs consisting of a non-distinctive, descriptive or generic element combined with other elements that take the sign as a whole beyond a minimum level of distinctiveness.

In practice this means that one of the main questions that the Office must answer is whether the mark is figurative enough to reach the minimum degree of distinctive character that is required for registration.

Finally, the fact that a sign contains figurative elements does not prevent it from still being misleading or contrary to public order or accepted principles of morality or from falling under other grounds of refusal, such as those set forth by [Article 7\(1\)\(h\), \(i\), \(j\) \(k\), \(l\) and \(m\) EUTMR](#).

Sign	EUTM No	Goods and services
	8 384 653	Classes 33, 35 and 39
<p>(09/03/2012, <a href="#">T-417/10</a>, ¡Que buena ye! Hijoputa, EU:T:2012:120)</p> <p>The application was rejected since 'Hijoputa' is an offensive and vulgar word in Spanish. The application was considered to be against accepted principles of morality (irrespective of the figurative elements of the sign) protected under <a href="#">Article 7(1)(f) EUTMR</a>.</p>		

Sign	EUTM No	Goods and services
------	---------	--------------------

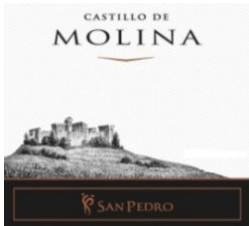
	11 402 781	Class 33
<p>The application was refused on the basis of <a href="#">Article 7(1)(j) EUTMR</a>, because it contains the protected geographical indication for wines 'MOLINA' (protected under the Agreement establishing an association between the European Union and its Member States, of the one part, and the Republic of Chile, of the other part). The distinctive figurative elements of the sign are irrelevant.</p>		

## 4.2 Assessment of the figurative threshold

The presence of figurative elements may give distinctive character to a sign consisting of a descriptive and/or non-distinctive word element so as to render it eligible for registration as an EUTM. Therefore, the question to be considered is whether the stylisation and/or the graphical features of a sign are sufficiently distinctive for the sign to act as a badge of origin.

In the framework of the European Union Intellectual Property Network (EUIPN), the Office and a number of trade mark offices in the European Union have agreed on a Common Practice in relation to when a figurative mark, containing purely descriptive/non-distinctive words, should pass the absolute grounds examination because the figurative element renders sufficient distinctive character (also referred to as Convergence Project 3 or CP3 Practice) <sup>(16)</sup>.

The Common Practice establishes criteria to determine if the threshold of distinctiveness is met due to the figurative features in the mark. They consider:

- **word elements** such as typeface and font, combination with colour, punctuation marks and/or other symbols, or how the words are placed (sideways, upside-down, etc.);
- **figurative elements** such as the use of simple geometric shapes, the position and proportion (size) of the figurative element(s) in relation to the word elements, or whether the figurative element is a representation of, or has direct link with, the goods and/or services, and whether the figurative element is commonly used in trade for the goods and/or services applied for;
- **both word and figurative elements** and how combinations of the criteria affect distinctiveness.

These criteria are explained in the following paragraphs.

<sup>16</sup> See Common Communication on the Common Practice of Distinctiveness — Figurative Marks containing descriptive/non-distinctive words, available at: <https://www.tmdn.org/network/documents/10181/278891cf-6e4a-41ad-b8d8-1e0795c47cb1>



Moreover, the Common Practice includes a number of examples. Some of them are included in the paragraphs below (marked as ‘CP3 example(s)’). The signs containing ‘Flavour and aroma’ seek protection for *coffee* in Class 30, the signs containing ‘Fresh sardine’ and ‘Sardines’ seek protection for *sardines* in Class 29, the sign containing ‘DIY’ seeks protection for *kits of parts for assembly into furniture* in Class 20, the signs containing ‘Pest control services’ seek protection for *pest control services* in Class 37, and the sign containing ‘Legal advice services’ seeks protection for *legal services* in Class 45.

In addition to the CP3 examples agreed by the Office and a number of trade mark offices in the European Union, the following paragraphs also include examples of EUTMs examined by the Office.

In the decision of 09/11/2018, [R 1801/2017-G](#), easyBank (fig.), the Grand Board not only confirmed the assessment made in the mark at stake (see below) but also the assessment in previous decisions (15 in total) regarding the impact of figurative elements on descriptive word elements (paras 71-72). Some of those cases can be found under the corresponding section.

#### 4.2.1 Word elements in a mark

##### Typeface and font

In general, descriptive/non-distinctive word elements appearing in basic/standard typeface, lettering or handwritten style typefaces — with or without font effects (bold, italics) — are not registrable.



##### *Non-distinctive examples*

Sign	Example
<b>Fresh Sardine</b>	CP3 example
<i>Fresh Sardine</i>	CP3 example
FrEsh SaRdine	CP3 example
<i>Flavour and aroma</i>	CP3 example
<i>Flavour and aroma</i>	CP3 example
<i>Flavour and aroma</i>	CP3 example

Sign	Case No	Goods and services
Foamplus	07/05/2008 <a href="#">R 655/2007-1</a>	Classes 1,3,7,17,22,37
<i>Superleggera</i>	<a href="#">T-464/08</a> EU:T:2010:212	Classes 12,18,25
<i>Crema di Bismacco</i>	EUTM No 5 225 156	Classes 29, 30

Where standard typefaces incorporate elements of graphic design as part of the lettering, those elements need to have sufficient impact on the mark as a whole to render it distinctive. When these elements are sufficient to distract the attention of the consumer from the descriptive meaning of the word element or likely to create a lasting impression of the mark, the mark is registrable.

#### *Distinctive examples*

Sign	Example
	CP3 example
	CP3 example
	CP3 example

Sign	Case No	Goods and services
	EUTM No 13 448 097	Classes 5,9,11,37,42,45

#### Combination with colour

The mere 'addition' of a single colour to a descriptive/non-distinctive word element, either to the letters themselves or as a background, will not be sufficient to give the mark distinctive character.

Use of colours is common in trade and would not be seen as a badge of origin. However, it cannot be excluded that a particular arrangement of colours that is unusual

and can be easily remembered by the relevant consumer could render a mark distinctive.

*Non-distinctive examples*

<b>CP3 examples</b>





Sign	Case No	Goods and services
	EUTM No 7 147 689	Classes 9, 38
	04/12/2014, <a href="#">T-494/13</a> , Watt, EU:T:2014:1022	Classes 35,39,42
	20/11/2015, <a href="#">T-202/15</a> , WORLD OF BINGO, EU:T:2015:914	Classes 9, 28, 41
	25/01/2019, Decision of the Grand Board of Appeal R <a href="#">1801/2017-G</a>	Classes 9, 36, 42



Combination with punctuation marks and other symbols

In general, the addition of punctuation marks or other symbols commonly used in trade does not add distinctive character to a sign consisting of descriptive/non-distinctive word elements.

*Non-distinctive examples*

<b>CP3 examples</b>
---------------------

<b>FreshSardine.™</b>
<b>“Flavour and aroma”</b>

Sign	Case No	Goods and services
	05/12/2002, <a href="#">T-91/01</a> , BioID, EU:T:2002:300	Classes 9,38,42
	01/02/2016, <a href="#">R 1451/2015-4</a>	Classes 3,4,14,16,18,20,21,25,30 ,32,33



Position of the word elements (sideways, upside-down, etc.)

In general, the fact that the word elements are arranged vertically, upside-down or in one or more lines is not sufficient to endow the sign with the minimum degree of distinctive character that is necessary for registration.

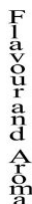
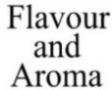
*Non-distinctive examples*



<b>CP3 examples</b>
Flavour and Aroma



Sign	Case No	Goods and services
------	---------	--------------------

	12/11/2014, <a href="#">T-504/12</a> , Notfall Creme, EU:T:2014:941	Classes 3, 5
	11/07/2012, <a href="#">T-559/10</a> , Natural beauty, EU:T:2012:362	Class 3

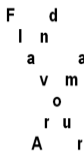
However, the way in which the word elements are positioned can add distinctive character to a sign when the arrangement is of such a nature that the average consumer focuses on it rather than immediately perceiving the descriptive message.

*Distinctive examples*

<b>CP3 examples</b>



Sign	EUTM No	Goods and services
	15 971 153	Classes 9, 16 and 35





4.2.2 Figurative elements (word element(s) and additional figurative element(s))

Use of simple geometric shapes

Descriptive or non-distinctive verbal elements combined with simple geometric shapes such as points, lines, line segments, circles, triangles, squares, rectangles,

parallelograms, pentagons, hexagons, trapezia and ellipses are unlikely to be acceptable, in particular when the abovementioned shapes are used as a frame or border.

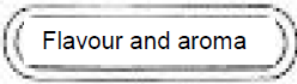

*Non-distinctive examples*

CP3 examples



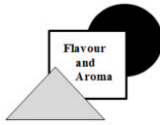
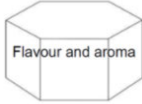

Sign	Case No	Goods and services
	09/07/2014, <a href="#">T-520/12</a> , Gifflar, EU:T:2014:620	Class 30
	EUTM No 6 039 119	Class 24
	EUTM No 11 387 941	Classes 9,35,41

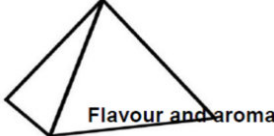
However, geometric shapes can add distinctiveness to a sign when their presentation, configuration or combination with other elements creates a global impression that is sufficiently distinctive.

*Distinctive examples*

CP3 examples







Sign	EUTM No	Goods and services
	13 899 455	Class 35

Position and proportion (size) of the figurative element in relation to the word element

In general, when a figurative element that is distinctive on its own is added to a descriptive and/or non-distinctive word element, then the mark is registrable, provided that said figurative element is, due to its size and position, clearly recognisable in the sign.



*Non-distinctive examples*

CP3 examples
<p>Flavour and aroma<sup>®</sup></p>
<p><i>Fresh Sardine</i></p>

Sign	Case No	Goods and services
	EUTM No 11 418 605	Classes 21, 24, 35
	21/05/2015, <a href="#">T-203/14</a> , Splendid, EU:T:2015:301	Classes 18, 25

*Distinctive examples*

CP3 example
 Flavour and aroma

Sign	EUTM No	Goods and services
	13 244 942	Classes 11, 37
	15 184 799	Classes 35, 41, 45
	13 906 458	Classes 12, 39

The figurative element is a representation of, or has a direct link with, the goods and/or services

A figurative element is considered to be descriptive and/or devoid of distinctive character whenever:



it is a true-to-life portrayal of the goods and services;

it is a symbolic/stylised — portrayal of the goods and services that does not depart significantly from the common representation of said goods and services.

*Non-distinctive examples*

CP3 examples





 <b>Fresh Sardine</b>
 <b>Sardines</b>
 <b>From the sea to your plate</b>

Sign	Case number	Goods and services
	29/07/2016, <a href="#">R 2194/2015-5</a>	Classes 32,33,43
	31/05/2016, <a href="#">T-454/14</a> , <b>STONE</b> (fig.), EU:T:2016:325  There is a clear link between the graphic representation of the mark applied for and the meaning of the word 'stone'.  The descriptive character of the mark applied for in relation to the goods at issue is not mitigated by their graphic representation (paras 90,91).	Classes 8, 21

*Distinctive examples*





Sign	Example
------	---------

	CP3 example
	CP3 example

A figurative element that does not represent the goods and services but has a direct link with the characteristics of the goods and services will not render the sign distinctive, unless it is sufficiently stylised.

*Non-distinctive examples*





CP3 example

Sign	EUTM No	Goods and services
	10 909 307	Classes 18, 21, 28, 31
	1 131 046	Classes 36, 42, 45
	874 778	Classes 9, 11
	14 512 784	Classes 11, 28, 37, 42

	14 584 262	Classes 9, 42
---	------------	---------------

*Distinctive examples*

<b>CP3 example</b>





Sign	Case No	Goods and services
	EUTM No 13 847 827	Classes 5, 31
	EUTM No 13 433 784	Classes 37,41,42
	11/02/2015, <a href="#">R 1983/2014-2</a>	Class 11
	EUTM No 13 893 871	Classes 29, 31

The figurative element is commonly used in trade in relation to the goods and/or services applied for

In general, figurative elements that are commonly used or customary in trade in relation to the goods and/or services claimed do not add distinctive character to the mark as a whole.

*Non-distinctive examples*

<b>CP3 examples</b>

<p>LEGAL ADVICE SERVICES</p> 

Sign	Case No	Goods and services
	EUTM No 116 434	Class 32
	03/07/2003, <a href="#">T-122/01</a> , Best Buy, EU:T:2003:183	Classes 35, 37, 42
	IR No W 01 116 291	Classes 29, 30, 43
	11/12/2015, <a href="#">R 1191/2015-5</a>	Classes 16, 29, 30, 35

#### 4.2.3 Word and figurative elements (stylised word elements and additional figurative element(s))

In general, a combination of figurative and word elements, which if considered individually are devoid of distinctive character, does not give rise to a distinctive mark.

Nevertheless, a combination of such elements when considered as a whole could be perceived as a badge of origin due to the presentation and composition of the sign. This will be the case when the combination results in an overall impression that is sufficiently far removed from the descriptive/non-distinctive message conveyed by the word element.

**Examples.** In order for a sign to be registrable, it must have a minimum level of distinctiveness. The purpose of the scale is to illustrate where that threshold is. The examples below from left to right contain elements with an increasing impact on the distinctiveness of the marks, resulting in marks that are either non-distinctive in their totality (red column) or distinctive in their totality (green column).



<p>1.</p>	
<p>2.</p>	
<p>3.</p>	

*Non-distinctive examples*

Sign	Case No	Goods and services
	03/12/2015, <a href="#">T-647/14</a> , DUALSAW, EU:T:2015:932	Classes 7, 8, 35
	24/06/2015, <a href="#">T-552/14</a> , Extra, EU:T:2015:462	Classes 3, 21, 30

*Distinctive examples*

Sign	EUTM No	Goods and services
	13 815 121	Classes 16, 21, 30

	14 585 939	Classes 29, 30, 32
	<a href="#">R 1551/2017-4</a>	Classes 3,5,18,28,31,35,38

## 5 Descriptiveness in the context of CP11 (sound marks, motion marks, multimedia marks and hologram marks)

In the framework of the European Union Intellectual Property Network, the trade mark offices of the European Union have agreed on a [Common Communication on New Types of Marks: Examination of Formal Requirements and Grounds for Refusal \(CP11\)](#). They agreed on examples of sound marks, motion marks, multimedia marks and hologram marks that are considered descriptive/non-distinctive for the corresponding goods and/or services. Some examples are reproduced below and further examples can be found in the [CP11](#).

In the same way that the general criteria for assessing distinctiveness of a traditional trade mark are applicable to new types of trade mark, the established principles to assess the descriptiveness of traditional marks or components thereof must be applied when assessing the descriptiveness of the verbal and/or figurative elements contained in a new type of trade mark.

### 5.1 Sound marks

In general, if a link between the sound(s) perceived in the mark and the goods and services applied for or their characteristics can be easily established, the sound mark will be considered descriptive. To the contrary, in general, when it is clear that there is no link between the sound perceived in the mark and the goods and/or services or their characteristics, the sound mark will not be considered descriptive.

#### Descriptive

Mark	Goods and services	Reasoning
------	--------------------	-----------

Sound of a barking dog <a href="#">CP11 example</a>	<i>Class 31: Foodstuffs and fodder for animals</i>	<i>The link between the sound and the goods applied for can easily be made and therefore the sound mark is considered descriptive of the claimed goods.</i>
--	--	---

## 5.2 Motion marks

In general, when the element(s) in the motion mark show(s) a realistic depiction of the goods and/or services applied for, or a related process, or if a link to the goods and/or services applied for or their characteristics can be easily established, the motion mark will be considered descriptive. This is especially so when the element(s) in motion do(es) not differ from a true-to-life portrayal of the representation of those goods and/or services.

However, in general, when the elements in the motion mark show an unconventional depiction of the goods and/or services applied for, or a related process differing significantly from a true-to-life portrayal of the representation of those goods and/or services, or no link with the goods and/or services can be easily established, the motion mark will not be considered descriptive.

Descriptive		
Mark	Goods and services	Reasoning
<a href="#">CP11 example</a>  	<i>Class 31: Fresh bananas</i>	<i>The movement does not add distinctiveness to the descriptive verbal element.</i>

## 5.3 Multimedia marks

In general, when the image and sound elements of the multimedia mark, show a realistic depiction of the goods and/or services applied for, or a related process, or if a link to the goods and/or services aimed for protection or their characteristics can be easily established, the multimedia mark will be considered descriptive. This is especially so when the elements in the multimedia mark do not differ from a true-to-life portrayal of the representation of those goods and/or services.

Notwithstanding the above, in general, when the subject matter of the image(s) and sound(s) of the multimedia mark show an unconventional depiction of the goods and/or

services applied for, or a related process, or if no link with the goods and/or services aimed for protection or their characteristics can be easily established, the multimedia mark will not be considered descriptive.

#### **Not considered descriptive**

<b>Mark</b>	<b>Multimedia mark</b>	<b>Multimedia mark</b>
<a href="#">CP11 example</a> 	Class 29: Tinned sardines	<i>The multimedia mark is not considered descriptive of the kind of goods as, although the depiction of the sardine is banal, it is flying in space, and thus as a whole it differs significantly from a true-to-life representation of the goods applied for.</i>

## **5.4 Hologram marks**

In general, when the elements in the hologram mark show a realistic depiction of the goods and/or services applied for, or if a link to the goods and/or services applied for or their characteristics can be easily established, the hologram mark will be considered descriptive.

This is especially so when the elements with holographic characteristics do not differ from a true-to-life portrayal of the representation of those goods and/or services.

Nevertheless, in general, when elements in the hologram mark show an unconventional depiction of the goods and/or services applied for, which differs significantly from a true-to-life portrayal of those goods and/or services, or have no connection with the goods and/or services, the hologram mark will not be considered descriptive.



***GUIDELINES FOR EXAMINATION OF  
EUROPEAN UNION TRADE MARKS***

***EUROPEAN UNION  
INTELLECTUAL PROPERTY OFFICE  
(EUIPO)***

***Part B***

***Examination***

***Section 4***

***Absolute grounds for refusal***

***Chapter 5***

***Customary signs or indications (Article 7(1)  
(d) EUTMR)***

## Table of Contents

<b>1 General Remarks.....</b>	<b>524</b>
<b>2 Point in Time of a Term Becoming Customary.....</b>	<b>525</b>
<b>3 Assessment of Customary Terms.....</b>	<b>526</b>

## 1 General Remarks

[Article 7\(1\)\(d\) EUTMR](#) excludes from registration signs that consist **exclusively** of words or indications that have become customary in the current language or in the bona fide and established practices of the trade at the relevant point in time (see [paragraph 2](#) below). In this context, the customary nature of the sign usually refers to something **other than** the properties or characteristics of the goods or services themselves.

Although there is a clear overlap between the scope of [Article 7\(1\)\(d\) and Article 7\(1\)\(c\) EUTMR](#), signs covered by [Article 7\(1\)\(d\) EUTMR](#) are excluded from registration not because they are descriptive, but on the basis of their **current usage** in trade sectors covering the goods or services for which the mark is applied for (04/10/2001, [C-517/99](#), Bravo, EU:C:2001:510, § 35).

Moreover, signs or indications that have become customary in the current language or in the bona fide and established practices of the trade to designate the goods or services covered by that sign are not capable of distinguishing the goods or services of one undertaking from those of other undertakings and do not, therefore, fulfil the essential function of a trade mark (16/03/2006, [T-322/03](#), Weisse Seiten, EU:T:2006:87, § 52).

This ground for refusal **also covers words that originally had no meaning** or had another meaning, for example, 'weiße Seiten' (= 'white pages'). It also covers certain **abbreviations** that have entered informal or jargon usage and have thereby become customary in trade.

Furthermore, a refusal based on [Article 7\(1\)\(d\) EUTMR](#) also covers **figurative elements** that are either frequently used pictograms or similar indications or have even become the standard designation for goods and services for which registration is sought, for example a white 'P' on a blue background for parking places, the Aesculapian staff for pharmacies, or the silhouette of a knife and fork for restaurant services.

Sign	Reasoning	Case No
 <p>EUTM No 9 894 528 covering goods in Class 9</p>	<p>'This device is identical to the international safety symbol known as "high voltage symbol" or "caution, risk of electric shock" ... It has been officially defined as such by the ISO 3864 as the standard high voltage symbol, whereby the device applied for is contained within the triangle which denotes that it is a hazard symbol ... Consequently, since it essentially coincides with the customary international sign to indicate a risk of high voltage, the Board deems it to be ineligible for registration as an EUTM in accordance with <a href="#">Article 7(1)(d) EUTMR</a>' (para. 20)</p>	<p><a href="#">R 2124/2011-5</a></p>

## 2 Point in Time of a Term Becoming Customary

The customary character must be assessed with reference to the **filing date of the EUTM application** (05/03/2003, [T-237/01](#), BSS, EU:T:2003:54, § 46; 05/10/2004, [C-192/03 P](#), BSS, EU:C:2004:587, § 39-40). Whether a term or figurative element was non-descriptive or distinctive long before that date, or when the term was first adopted, will in most cases be immaterial, since it does not necessarily prove that the sign in question had not become customary by the filing date (05/03/2003, [T-237/01](#), BSS, EU:T:2003:54, § 47; similarly, 21/05/2014, [T-553/12](#), BATEAUX MOUCHES, EU:T:2014:264).

In some cases, a sign applied for may become customary **after the filing date**. Changes in the meaning of a sign that lead to a sign becoming customary after the filing date do not lead to a declaration for invalidity *ex tunc* under [Article 59\(1\)\(a\) EUTMR](#), but can lead to a **revocation** with effect *ex nunc* under [Article 58\(1\)\(b\) EUTMR](#). For example, the EUTM registration 'STIMULATION' was cancelled on the grounds that it had become a term customarily used for energy drinks. For further information, see [the Guidelines, Part D, Cancellation, Section 2, Substantive Provisions](#).

### 3 Assessment of Customary Terms

Whether a mark is customary must be assessed, firstly, by reference to the goods or services for which registration is sought, and, secondly, on the basis of the target public's perception of the mark (07/06/2011, [T-507/08](#), 16PF, EU:T:2011:253, § 53).

As regards the **link with the goods and services** for which registration is sought, [Article 7\(1\)\(d\) EUTMR](#) will not apply where the mark is a more general laudatory term that has no particular customary link with the goods and services concerned (04/10/2001, [C-517/99](#), Bravo, EU:C:2001:510, § 27, 31).

As regards the **relevant public**, the customary character must be assessed by taking account of the expectations that the average consumer, who is deemed to be reasonably well informed and reasonably observant and circumspect, is presumed to have in respect of the type of goods in question (16/03/2006, [T-322/03](#), Weisse Seiten, EU:T:2006:87, § 50). The Court has clarified a number of issues in this respect.

- The relevant public to be taken into account in determining the sign's customary character comprises not only all consumers and end users but also, depending on the features of the market concerned, **all those in the trade who deal with that product commercially** (29/04/2004, [C-371/02](#), Bostongurka, EU:C:2004:275, § 26; 06/03/2014, [C-409/12](#), Kornspitz, EU:C:2014:130, § 27).
- Where the trade mark targets both **professionals and non-professionals** (such as intermediaries and end users), it is sufficient for a sign to be refused or revoked if it is perceived to be a usual designation by any one sector of the relevant public, notwithstanding that another sector may recognise the sign as a badge of origin (06/03/2014, [C-409/12](#), Kornspitz, EU:C:2014:130, § 23-26).
- The General Court has held that [Article 7\(1\)\(d\) EUTMR](#) is not applicable when the sign's use in the market is **by one sole trader (other than the EUTM applicant)** (07/06/2011, [T-507/08](#), 16PF, EU:T:2011:253). In other words, a mark will not be regarded as customary purely for the simple reason that a competitor of the EUTM applicant also uses the sign in question. For customary character to be demonstrated, it is necessary for the examiner to provide evidence (which will generally come from the internet) that the relevant consumer has been exposed to the mark in a non-trade mark context and that, as a result, they recognise its customary significance vis-à-vis the goods and services for which the trade mark is filed.

# ***GUIDELINES FOR EXAMINATION OF EUROPEAN UNION TRADE MARKS***

## ***EUROPEAN UNION INTELLECTUAL PROPERTY OFFICE (EUIPO)***

### ***Part B***

#### ***Examination***

#### ***Section 4***

#### ***Absolute grounds for refusal***

#### ***Chapter 6 Shapes or Other Characteristics that Result from the Nature of the Goods, are Necessary to Obtain a***

#### ***Technical Result or give Substantial Value to the Goods (Article 7(1)(e) EUTMR)***

## Table of Contents

<b>1 General Remarks.....</b>	<b>529</b>
<b>2 Shape or Other Characteristics Resulting from the Nature of the Goods..</b>	<b>531</b>
<b>3 Shape or Other Characteristics of Goods Necessary to Obtain a Technical Result.....</b>	<b>532</b>
<b>4 Shape or Other Characteristics Giving Substantial Value to the Goods....</b>	<b>538</b>

## 1 General Remarks

[Article 7\(1\)\(e\) EUTMR](#) excludes from registration signs that consist exclusively of (i) the shape or another characteristic that results from the nature of the goods themselves; (ii) the shape or another characteristic of goods that is necessary to obtain a technical result; or (iii) the shape or another characteristic of the goods that gives substantial value to the goods.

The wording of this provision implies, in principle, that it does not apply to signs for which registration is sought in respect of services.

In relation to shapes, the **objective** pursued by [Article 7\(1\)\(e\) EUTMR](#) is the same for all of its three grounds, namely to prevent the exclusive and permanent rights that a trade mark confers from serving to extend the life of other IP rights indefinitely, such as patents or designs, which the EU legislature has sought to make subject to limited periods (18/09/2014, [C-205/13](#), Tripp Trapp, EU:C:2014:2233, § 19-20; 14/09/2010, [C-48/09 P](#), Lego brick, EU:C:2010:516, § 43; 06/10/2011, [T-508/08](#), Loudspeaker, EU:T:2011:575, § 65).

[Article 7\(1\)\(e\) EUTMR](#) does not define the category of mark that is considered a shape within the meaning of that provision. **It makes no distinction between 2D and 3D shapes, and 2D representations of 3D shapes.** Therefore, [Article 7\(1\)\(e\) EUTMR](#) is applicable not only to 3D shapes but also to other categories of marks, such as figurative signs representing shapes (06/03/2014, [C-337/12 P](#) – [C-340/12 P](#), Surface covered with circles, EU:C:2014:129, § 55).

[Regulation \(EU\) 2015/2424](#) of the European Parliament and of the Council amending the Community Trade Mark Regulation introduced the reference to ‘another characteristic’ of goods. The CJEU has not yet ruled on how these words are to be interpreted.

In the framework of the European Union Intellectual Property Network, the trade mark offices of the European Union have agreed on a [Common Communication on New Types of Marks: Examination of Formal Requirements and Grounds for Refusal \(CP11\)](#). They agreed on examples of sound marks, motion marks and multimedia marks that are considered not objectionable/objectionable as they consist of characteristics that result from the nature of the goods, are necessary to obtain a technical result or give substantial value to the goods. Some examples are reproduced below and further examples can be found in the [CP11](#).

Importantly, unlike the situation covered by Article 7(1)(b) EUTMR, the **average consumer’s perception is not a decisive element** when applying the ground for refusal under Article 7(1)(e) EUTMR but, **at most**, may be a relevant criterion for the Office when identifying the sign’s essential characteristics (18/09/2014, [C-205/13](#), Tripp Trapp, EU:C:2014:2233, § 34).

For these reasons, **an objection under [Article 7\(1\)\(e\) EUTMR](#)** to marks consisting of shapes or other characteristics that follow from the nature of the goods; shapes or other characteristics that are necessary to obtain a technical result; or shapes or other



characteristics giving substantial value to the goods **cannot be overcome** by demonstrating that they have **acquired distinctive character**. In other words, [Article 7\(3\) EUTMR](#) is not applicable to such shapes or other characteristics, regardless of whether that particular shape or another characteristic might actually be distinctive in the marketplace.

It is therefore essential to **undertake a prior examination of the sign under [Article 7\(1\)\(e\) EUTMR](#) where several of the absolute grounds for refusal provided for in [Article 7\(1\) EUTMR](#) may apply** (06/10/2011, [T-508/08](#), Loudspeaker, EU:T:2011:575, § 44).

For the sake of sound administration and economy of proceedings, the Office will raise any objections to registration of the sign under [Article 7\(1\) EUTMR](#) simultaneously in one communication. The reasoning of the objection will address first [Article 7\(1\)\(e\) EUTMR](#), even if this ground for refusal may be less evident than, for instance, an objection for a lack of distinctiveness under [Article 7\(1\)\(b\) EUTMR](#). This is justified by the fact that registration of a sign that falls foul of [Article 7\(1\)\(e\) EUTMR](#) is clearly impossible even if acquired distinctiveness through use has been proven.

It may also be the case that, following an initial objection under [Article 7\(1\)\(b\) and/or \(c\) EUTMR](#), the evidence submitted by the applicant shows that the sign consists exclusively of a shape or another characteristic as listed in [Article 7\(1\)\(e\) EUTMR](#). In these cases, an objection under [Article 7\(1\)\(e\) EUTMR](#) should be raised as well.

A sign consists ‘**exclusively**’ of the shape of goods or other characteristics when all its **essential characteristics** — that is to say, its most important elements — result from the nature of the goods ([Article 7\(1\)\(e\)\(i\) EUTMR](#)), perform a technical function ([Article 7\(1\)\(e\)\(ii\) EUTMR](#)) or give substantial value to the goods ([Article 7\(1\)\(e\)\(iii\) EUTMR](#)). The presence of one or more minor arbitrary elements, therefore, will not alter the conclusion (18/09/2014, [C-205/13](#), Tripp Trapp, EU:C:2014:2233, § 21-22; 14/09/2010, [C-48/09 P](#), Lego brick, EU:C:2010:516, § 51-52). However, an objection under [Article 7\(1\)\(e\) EUTMR](#) would not be justified if the sign applied for were a shape or other characteristic(s) combined with additional, distinctive matter such as word or figurative elements (that qualify as essential characteristics of the sign), as the sign in its entirety would then not consist exclusively of a shape or other characteristic(s) (see [Step 3 in the Guidelines, Part B, Examination, Section 4, Absolute Grounds for Refusal, Chapter 3, Non-Distinctive Trade Marks \(Article 7\(1\)\(b\) EUTMR\), paragraph 10.3](#)).

The correct application of [Article 7\(1\)\(e\) EUTMR](#) requires that **the essential characteristics of the sign at issue be properly identified**. There is no hierarchy that applies systematically between the various types of elements of which a sign may consist. Moreover, in determining the essential characteristics of a sign, the Office may either base its assessment directly on the overall impression produced by the sign, or first examine in turn each of the components of the sign concerned (14/09/2010, [C-48/09 P](#), Lego brick, EU:C:2010:516, § 70; 19/09/2012, [T-164/11](#), Knife handles, EU:T:2012:443, § 37).

This identification may, depending on the case and in particular its degree of difficulty, 'be carried out by means of a simple visual analysis of the sign or, alternatively, be based on a detailed examination in which relevant assessment criteria may be taken into account, such as surveys or expert opinions, or data relating to intellectual property rights conferred previously for the goods concerned', such as patents (14/09/2010, [C-48/09 P](#), Lego brick, EU:C:2010:516, § 71, 85).

Once the sign's essential characteristics have been identified, it will have to be established **whether they all fall under the respective ground set out in Article 7(1)(e) EUTMR** (14/09/2010, [C-48/09 P](#), Lego brick, EU:C:2010:516, § 72). In this respect, each of the three grounds must be applied independently of the others. In addition, where none of those grounds is fully applicable for the entire shape or another characteristic, they do not preclude registration of the sign (18/09/2014, [C-205/13](#), Tripp Trapp, EU:C:2014:2233, § 39, 42). Therefore, if parts of the shape or other characteristics are necessary to obtain a technical result within the meaning of [Article 7\(1\)\(e\)\(ii\) EUTMR](#), for instance, and the remaining parts merely give substantial value to the goods under [Article 7\(1\)\(e\)\(iii\) EUTMR](#), neither of these two provisions bars the registration of the shape or other characteristics as a sign.

## 2 Shape or Other Characteristics Resulting from the Nature of the Goods

Under [Article 7\(1\)\(e\)\(i\) EUTMR](#), signs that consist exclusively of the shape or another characteristic that results from the nature of the goods themselves cannot be registered.

This ground for refusal will apply when the sign, whether 2D or 3D, consists exclusively of the only natural shape of the good, that is, **'natural' products that have no substitute**: for example, the realistic representation below of a banana for bananas.



The same would apply to **'regulated' products** (the shape or another characteristic of which is prescribed by legal standards), such as a rugby ball.

Apart from 'natural' and 'regulated' products, all shapes that are **inherent to the generic function or functions** of such goods must, in principle, also be denied registration (18/09/2014, [C-205/13](#), Tripp Trapp, EU:C:2014:2233, § 23-25). The Court of Justice has not given any further guidance about exactly when a shape is inherent to the generic function(s) of goods. In the absence of any case-law in this respect, the examples given by the Advocate General may be referred to: legs with a horizontal level for a table; an orthopaedic-shaped sole with a V-shaped strap for flip-flops (18/09/2014, [C-205/13](#), Tripp Trapp, EU:C:2014:322, § 59). Even though the opinion of the Advocate General is not binding, it can give useful guidance.

There is no practice yet on cases where a trade mark consists of ‘**other characteristics**’ that result from the nature of the goods. As an invented example, a sound mark representing the sound of a motorbike for *motorbikes* could be captured by [Article 7\(1\)\(e\)\(i\) EUTMR](#) if the sound results from the nature of the goods (in the sense of its technical performance). Another hypothetical example of a sign that consists exclusively of ‘other characteristics’ resulting from the nature of the goods could be an olfactory mark of a scent for a *perfume*.

CP11 provides some examples of ‘new types of marks’ that would be rejected because the sign results from the nature of the goods applied for:

<p>Sound mark (chainsaw)</p> <p><a href="#">LINK</a></p>	<p>Class 7: <i>Chainsaws</i></p>	<p>This sound results from the nature of the goods applied for; therefore it would be rejected based on <a href="#">Article 7(1)(e)(i) EUTMR</a>.</p>
<p>Multimedia mark</p>  <p><a href="#">LINK</a></p>	<p>Class 9: <i>Metronomes</i></p>	<p>The sound and movement are a result of the nature of the goods themselves; therefore the mark would be rejected based on <a href="#">Article 7(1)(e)(i) EUTMR</a>.</p>

### 3 Shape or Other Characteristics of Goods Necessary to Obtain a Technical Result

[Article 7\(1\)\(e\)\(ii\) EUTMR](#) excludes from registration signs that consist exclusively of the shape or another characteristic of goods that is necessary to obtain a technical result. Its aim is to prevent an undertaking from obtaining a monopoly on technical solutions or functional solutions of a product (14/09/2010, [C-48/09 P](#), Lego brick, EU:C:2010:516, § 43).

The CJEU has not yet ruled on how to interpret ‘another characteristic’ of the goods. Other characteristics of goods that are necessary for obtaining a technical result may include particular sounds. For instance, as an invented example, a sound mark for insect repellents may be objected to under [Article 7\(1\)\(e\)\(ii\) EUTMR](#) if the sound does indeed repel insects.

Common Communication on New Types of Marks: Examination of Formal Requirements and Grounds for Refusal ([CP11](#)) provides some examples of sound/motion marks that consist exclusively of the sound/motion that is necessary to obtain a technical result:

<p>Sound (clapping)</p> <p><a href="#">LINK</a></p>	<p>Class 9: <i>Audio-sensitive controls for lighting apparatus</i></p>	<p>This sound mark consists exclusively of the sound that is necessary to obtain a technical result and thus cannot constitute a trade mark.</p>
<p>Motion mark (thermostat)</p>  <p>Figure 3:</p> <p><a href="#">LINK</a></p>	<p>Class 9: <i>Thermostats</i></p>	<p>The movement of the goods applied for is necessary to obtain a technical result; therefore it would be rejected based on <a href="#">Article 7(1)(e)(ii) EUTMR</a>.</p>

A sign consists ‘exclusively’ of the shape of goods (or other characteristics) that is necessary to obtain a technical result when all the essential characteristics of a shape (or other characteristics) perform a technical function.

First, the essential characteristics of the shape [or other characteristics] must be identified; then they must be assessed to see whether they are all necessary for obtaining a technical result.

#### 1. Identification of the essential characteristics of a sign

The essential characteristics of the sign at issue must be properly identified (06/03/2014, [C-337/12 P](#) – [C-340/12 P](#), Surface covered with circles, EU:C:2014:129, § 46 and the case-law cited therein).

The expression ‘essential characteristics’ must be understood as referring to the most important elements of the sign (14/09/2010, [C-48/09 P](#), Lego brick, EU:C:2010:516, § 68-69).

Identification of the essential characteristics of a sign is carried out on a case-by-case basis, with no hierarchy between the various types of elements of which a sign may consist. It can be based directly on the overall impression produced by the sign

or by examining in turn each of the components of the sign concerned (14/09/2010, [C-48/09 P](#), Lego brick, EU:C:2010:516, § 70 and the case-law cited therein).

Identification may be by simple visual analysis of the sign or by a detailed examination in which relevant assessment criteria are applied, such as surveys, expert opinions, or data relating to intellectual property rights previously conferred in respect of the goods concerned.

Information other than that relating to the graphic representation alone, such as the perception of the relevant public, may be used in order to identify the essential characteristics of the sign at issue (23/04/2020, [C-237/19](#), Gömböc Kutató, EU:C:2020:296, § 37). For further details regarding the consumer's perception in relation to sound, motion and multimedia marks that might be relevant under this ground, please see the [CP11](#).

For the purposes of [Article 7\(1\)\(e\)\(ii\) EUTMR](#), it is irrelevant whether the 'essential characteristics' or 'most important elements' of the sign are distinctive or not (24/09/2019, [T-261/18](#), DEVICE OF A BLACK SQUARE CONTAINING SEVEN CONCENTRIC BLUE CIRCLES (fig.), EU:T:2019:674, § 51).

The presence of non-essential characteristics with no technical function is also irrelevant under [Article 7\(1\)\(e\)\(ii\) EUTMR](#) (14/09/2010, [C-48/09 P](#), Lego brick, EU:C:2010:516, § 51).

## 2. Are all the essential characteristics necessary for obtaining a technical result?

For this ground of refusal to apply, the essential characteristics of the sign at issue must **all be technically necessary for obtaining the intended technical result** of the goods concerned. [Article 7\(1\)\(e\)\(ii\) EUTMR](#) does not apply where there is a decorative or imaginative element or a distinctive word component that is an essential characteristic of the sign but is not necessary for obtaining a technical result.

This ground applies even if the essential characteristics represented in the sign are not sufficient in themselves to achieve the technical result, but merely contribute to it (24/10/2019, [T-601/17](#), Cubes (3D), EU:T:2019:765, § 94).

The representation does not have to reveal **all** the elements that are necessary for the implementation of the technical solution concerned, provided it is shown that the implementation of that technical solution cannot be effective without the essential characteristics that are visible in the graphic representation (24/10/2019, [T-601/17](#), Cubes (3D), EU:T:2019:765, § 96).

The essential characteristics of the shape or of another characteristic of the goods necessary to obtain a technical result **must, wherever possible, be assessed in the light of the technical function of the actual goods represented**. Such analysis cannot be made without taking into consideration, where appropriate, any **additional elements relating to the function of the actual goods**, even if they are not visible in the representation. For example, in a case relating to a 'Rubik's Cube'-type puzzle, the Court of Justice found that the functionality of the grid structure should have been examined in the light of the rotating capability of the individual

elements of the puzzle (10/11/2016, [C-30/15 P](#), CUBES (3D), EU:C:2016:849, § 47-51).

Therefore, when examining the functional characteristics of a sign, the competent authority may carry out a detailed examination that takes into account material relevant for appropriately identifying the essential characteristics of a sign, in addition to the representation and any descriptions filed at the time of the application for registration (24/10/2019, [T-601/17](#), Cubes (3D), EU:T:2019:765, § 87 and case-law quoted). This material may consist, for example, of a product catalogue or advertising material (24/09/2019, [T-261/18](#), DEVICE OF A BLACK SQUARE CONTAINING SEVEN CONCENTRIC BLUE CIRCLES (fig.), EU:T:2019:674). Information which is not apparent from the graphic representation must originate from objective and reliable sources and may not include the perception of the relevant public (23/04/2020, [C-237/19](#), Gömböc Kutató, EU:C:2020:296, § 37).

The fact that, for example, the shape concerned is, or has been, the subject of a claim in a **registered patent or a patent application** constitutes prima facie evidence that the aspects of the shape identified in the patent claim as functional are necessary for achieving a technical result (this approach has been followed by the Boards of Appeal, for example in their decision of 17/10/2013, [R 42/2013-1](#), FORM EINES STÖPSELS (3D MARKE)).

The fact that there may be alternative shapes, with other dimensions or another design, capable of achieving the same technical result does not in itself mean that this provision does not apply (14/09/2010, [C-48/09 P](#), Lego brick, EU:C:2010:516, § 53-58). The same reasoning is applicable by analogy regarding the other characteristics of the goods in the sense of [Article 7\(1\)\(e\)\(ii\)](#).

Likewise, the combination of different elements that are all functional in themselves does not make the sign registrable.

The functions performed by the essential characteristics of the shape or another characteristic of the goods must be assessed in the light of the actual goods concerned.

In assessing an EUTM application against [Article 7\(1\)\(e\)\(ii\) EUTMR](#), consideration should be given to the meaning of the expression '**technical result**'. This expression should be interpreted broadly and includes shapes or other characteristics that, for example:

- fit with another article;
- give the most strength;
- use the least material;
- facilitate convenient storage or transportation.

Sign	Case No	Goods and services
------	---------	--------------------

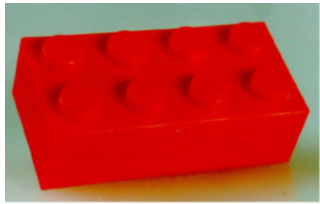

	<p>EUTM No 107 029</p> <p>10/07/2006, <a href="#">R 856/2004 G</a></p> <p>12/11/2008, <a href="#">T-270/06</a></p> <p>14/09/2010, <a href="#">C-48/09 P</a></p>	<p>Class 28</p> <p>(<i>construction toys</i>)</p>
<p><b>The Grand Board</b> held that the various features of a Lego brick all performed ... particular technical functions, namely: <i>the bosses [studs]</i>: height and diameter for clutch power; number for fixing versatility; layout for fixing arrangement; <i>the secondary projections</i>: clutch-power; the number for best clutch-power in all positions; the thickness of the wall to act as a spring; <i>sides</i>: connected with sides of other bricks to produce a wall; <i>hollow skirt</i>: to mesh with the bosses and to enable fixing for clutch power; and <i>overall shape</i>: brick shape for building; size for children to hold (10/07/2006, <a href="#">R 856/2004-G</a>, 3D SHAPE OF LEGO BRICK, § 54).</p> <p>The <b>General Court</b> confirmed the Grand Board's findings, holding that the latter had applied <a href="#">Article 7(1)(e)(ii) EUTMR</a> correctly (12/11/2008, <a href="#">T-270/06</a>, Lego brick, EU:T:2008:483).</p> <p>The <b>Court of Justice</b> confirmed the General Court's judgment, holding that ... the solution incorporated in the shape of goods examined is the technically preferable solution for the category of goods concerned. If the three-dimensional sign consisting of such a shape were registered as a trade mark, it would be difficult for the competitors of the proprietor of that mark to place on the market shapes of goods constituting a real alternative, that is to say, shapes which are not similar and which are nevertheless attractive to the consumer from a functional perspective (14/09/2010, <a href="#">C-48/09 P</a>, Lego brick, EU:C:2010:516, § 60).</p>		

Sign	Case No
	<p>19/09/2012, <a href="#">T-164/11</a></p>

**1. Identification of the essential characteristics**

In this case, the shape applied for was described as

... a slightly curved knife handle characterised by a small angle of 5 to 10 degrees between the knife blade and the longitudinal axis of the shell grip, which has a middle section with a somewhat rounded outer cross section, which broadens towards a tapered rear end. The handle also incorporates a knurled screw in the shell of the knife

(19/09/2012, [T-164/11](#), Knife handles, EU:T:2012:443, § 28).

**2. Assessment of technical function of those characteristics**

The Court stated that

As is apparent from that patent [relied on by the invalidity applicant], the technical effect of the angle between the knife blade and the longitudinal axis of the mother-of-pearl handle is to facilitate cutting. The intermediate section is of particular importance for long cuts. It makes the cut more precise while allowing greater pressure to be exerted. Finally, the knurled screw allows the shell to be opened and the blades of the knife to be changed without using other tools and without hindering manipulation of the knife during use

(19/09/2012, [T-164/11](#), Knife handles, EU:T:2012:443, § 30).

It concluded that the most important elements of the sign, constituting its essential characteristics, were all exclusively functional (para. 33), noting that

In this case, ... the Board of Appeal did state ... that the shape of the knife constituting the disputed trade mark could be perceived as being a fish or a dolphin. However, that resemblance with a fish is conditioned by elements having a technical function, namely the invention covered by the expired American patent with a slightly less curved handle and a slight prolongation of the points at the rear end

(19/09/2012, [T-164/11](#), Knife handles, EU:T:2012:443, § 39).

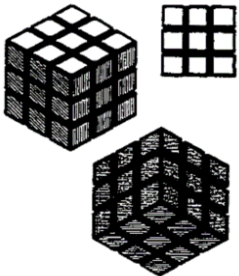
Sign	Case No	Goods and services
	<p>EUTM No 162 784                      24/10/2019, <a href="#">T-601/17</a>                      (23/04/2020, <a href="#">C-936/19 P</a>, Cubes (3D), EU:C:2020:286)</p>	<p>Class 28  <i>Three dimensional puzzles</i></p>



Para. 70: ‘... the essential characteristics of the contested mark are limited to the overall cube shape, on the one hand, and to the black lines and little squares on each face of the cube, on the other.’

Para. 86: ‘... those black lines actually represent a physical separation between the different small cubes, allowing a player to rotate each row of small cubes independently of each other in order to gather those small cubes, in the desired colour scheme, on the cube’s six faces. Such a physical separation is necessary to rotate, vertically and horizontally, the different rows of small cubes by means of a mechanism located in the centre of the cube. Without such a physical separation, the cube would be nothing more than a solid block in which none of the individual elements could move independently of the others.’

Para. 96: ‘It is apparent from that judgment on appeal that the fact that the rotating capability of the vertical and horizontal lattices of the ‘Rubik’s Cube’ resulted from a mechanism internal to the cube, that is, an element which was not visible in the graphic representation of the contested mark, did not prevent the Board of Appeal from being able to have regard to that rotating capability in its analysis of the functionality of the essential characteristics of that mark.’

Para. 98: ‘... given that the two characteristics of the contested mark which have been correctly identified as essential by the Board of Appeal, in the present case the overall cube shape, on the one hand, and the black lines and the little squares on each face of the cube, on the other, are necessary to obtain the intended technical result of the actual goods concerned (see paragraphs 85 to 90 above), it must be concluded that that mark falls within the ground referred to in Article 7(1)(e)(ii) of Regulation No 40/94.’

## 4 Shape or Other Characteristics Giving Substantial Value to the Goods

Under [Article 7\(1\)\(e\)\(iii\) EUTMR](#), signs that consist exclusively of the shape or another characteristic that gives substantial value to the goods cannot be registered or, if registered, they are liable to be declared invalid.

Whereas the same shape or another characteristic can, in principle, be protected both as a design and as a trade mark, [Article 7\(1\)\(e\)\(iii\) EUTMR](#) only refuses trade mark protection for shapes or other characteristics in certain specific cases, namely, when the sign consists exclusively of a shape or another characteristic that gives substantial value to the product.

The **concept of ‘value’** should be interpreted not only in commercial (economic) terms, but also in terms of ‘attractiveness’, that is to say, the likelihood that the goods will be purchased **primarily because of** their particular shape or another particular characteristic. When other characteristics may give the product significant value in addition to this aesthetic value, such as functional value (for instance safety, comfort and reliability), [Article 7\(1\)\(e\)\(iii\) EUTMR](#) cannot be ruled out automatically. Indeed, the concept of ‘value’ cannot be limited purely to the shape or another characteristic of goods having only artistic or ornamental value (18/09/2014, [C-205/13](#), Tripp Trapp, EU:C:2014:2233, § 29-32).

**The concept of ‘value’ should not be interpreted as meaning ‘reputation’**, since application of this absolute ground for refusal is justified exclusively by the effect on the value added to the goods **by the shape or other characteristic** and not by other factors, such as the reputation of the word mark that is also used to identify the goods in question (16/01/2013, [R 2520/2011-5](#), SHAPE OF GUITAR BODY (3D), § 19).

Furthermore, that the shape or other characteristic may be **pleasing or attractive** is not sufficient to exclude it from registration. If that were the case, it would be virtually impossible to imagine any trade mark of a shape or another characteristic, given that in modern business there is no product of industrial utility that has not been the subject of study, research and industrial design before its eventual launch on the market (03/05/2000, [R 395/1999-3](#), SINGLE SQUARE CLASP, § 1-2, 22-36).

In assessing the value of the goods, account may be taken of **criteria** such as the nature of the category of goods concerned, the artistic value of the shape or other characteristic in question, its dissimilarity from other shapes in common use on the market concerned, a substantial price difference compared with similar goods, and the development of a promotion strategy that focuses on accentuating the aesthetic characteristics of the product in question (18/09/2014, [C-205/13](#), Tripp Trapp, EU:C:2014:2233, § 35).

The fact that the shape also performs other functions in addition to its aesthetic function (e.g. functional functions) does not exclude the application of [Article 7\(1\)\(e\)\(iii\) EUTMR](#) (18/09/2014, [C-205/13](#), Tripp Trapp, EU:C:2014:2233, § 31).

An example of a sign that consists exclusively of ‘other characteristics’ that give substantial value to the goods could be a sound mark, representing a specific sound of a *motorbike* that may be appealing to a significant part of the relevant public to the extent that it may indeed affect the consumer’s choice of purchase.

For the examination of these trade marks, a **case-by-case approach is necessary**. [Article 7\(1\)\(e\)\(iii\) EUTMR](#) applies when it is apparent from objective and reliable evidence that a consumer’s decision to purchase the goods in question is, to a very great extent, determined by one or more features of the shape or another characteristic which alone forms the sign (23/04/2020, [C-237/19](#), Gömböc Kutató, EU:C:2020:296, §41).

It is important to determine whether **the aesthetic value of a shape (or, by analogy, other characteristic) can, in its own right, determine the commercial value of the product and the consumer’s choice to a large extent**. It is immaterial whether the overall value of the product is also affected by other factors, if the value contributed by the shape or other characteristic itself is substantial.

If a shape or other characteristic derives its appeal from the fame of its designers and/or marketing efforts rather than from the aesthetic value of the shape or other characteristic itself, [Article 7\(1\)\(e\)\(iii\) EUTMR](#) will not apply (14/12/2010, [R 486/2010-2](#), SHAPE OF A CHAIR (3D), § 20-21).

Example of refused trade mark

Sign	Case No	Goods
	<p>10/09/2008, <a href="#">R 497/2005-1</a>, LOUDSPEAKER (3D)</p> <p>06/10/2011, <a href="#">T-508/08</a>, Loudspeaker</p>	<p>Apart from loudspeakers, other apparatus for the reception, processing, reproduction, regulation or distribution of sound signals in Class 9 as well as music furniture in Class 20.</p>

The General Court confirmed the Board of Appeal's finding that the sign at issue fell within the scope of [Article 7\(1\)\(e\)\(iii\) EUTMR](#) (06/10/2011, [T-508/08](#), Loudspeaker, EU:T:2011:575).

The General Court held that for goods such as those listed above, the design was an element that would be very important in the consumer's choice even if the consumer took other characteristics of the goods at issue into account. After having stated that the shape for which registration was sought revealed a very specific design and that it was an essential element of the applicant's branding, which increased the appeal of the product and, therefore, its value, the General Court also noted that it was apparent from the evidence on record, namely extracts from the distributors' websites and online auction or second-hand websites, that the aesthetic characteristics of that shape were emphasised first and that the shape was perceived as a kind of pure, slender, timeless sculpture for music reproduction, which made it an important selling point (06/10/2011, [T-508/08](#), Loudspeaker, EU:T:2011:575, § 75). The General Court thus concluded that, independently of the other characteristics of the goods at issue, the shape for which registration was sought bestowed substantial value on the goods concerned.

Examples where it was upheld that the shape or other characteristics did not give substantial value to the goods

EUTM	Case No
	<p>EUTM 10 350 593</p> <p>29/03/2016, <a href="#">R 590/2015-4</a>, SPEISEEIS</p>

Para 30: an ice-cream does not become ‘more valuable’ as a result of its shape in the sense that the provider could demand a higher price for it. Instead, the ‘value’ of the product is merely that of performing trade mark functions. This has nothing to do with the ‘value of the goods’ that is intended by [Article 7\(1\)\(e\)\(iii\) EUTMR](#).

Para 35: if the EUTM proprietor’s website refers to the presentation of ice cream at events that are primarily aimed at designers, the latter do not constitute the relevant public. The relevant public consists of general end consumers. Their perception must be taken as a basis, and the effect that the product at issue would have on the consumer when purchasing an ‘ice cream’ (and not in a design museum) must be examined by way of an a priori decision.

EUTM	Case No
	<p>EUTM 12 309 795</p> <p><u>BOTTIGLIA ROSA</u></p> <p>(08/05/2019, <a href="#">T-325/18</a>, BOTTIGLIA ROSA (3D), EU:T:2019:299)</p>

The Court confirmed the finding of the BoA: the shape of the bottle and the reflective golden colour are the essential characteristics of the sign. The shape of the bottle is banal, its design clearly cannot be described as being ‘striking’, ‘particular’ or ‘easily remembered’ and the colour and mirror effect of the surface of the bottle provides no striking or particular design element. Neither of the two essential characteristics of the sign is sufficient, in itself, to give substantial value to the goods. Nor can such substantial value arise from the combination or sum of two characteristics that are neither ‘striking’, nor ‘particular’ nor ‘easily remembered’.

**GUIDELINES FOR EXAMINATION**

**EUROPEAN UNION**  
**INTELLECTUAL PROPERTY OFFICE**  
**(EUIPO)**

**Part B**

**Examination**

**Section 4**

**Absolute grounds for refusal**

**Chapter 7**

**Trade marks contrary to public policy or  
acceptable principles of morality (Article  
7(1)(f) EUTMR)**

## Table of Contents

<b>1 General Remarks.....</b>	<b>544</b>
<b>2 `Public Policy'.....</b>	<b>545</b>
2.1 Concept and categories.....	545
<b>3 Accepted Principles of Morality.....</b>	<b>546</b>
<b>4 Examples.....</b>	<b>549</b>
4.1 Examples of rejected EUTM applications.....	549
4.2 Examples of accepted EUTM applications.....	554

## 1 General Remarks

[Article 7\(1\)\(f\) EUTMR](#) excludes from registration trade marks that are contrary to public policy or to accepted principles of morality. [Article 7\(1\)\(f\) EUTMR](#) mirrors that of Article 6*quinquies*(B)(3) of the Paris Convention <sup>(17)</sup>, which provides for the refusal of trade mark applications and for the invalidation of registrations where trade marks are ‘contrary to morality or public order’.

The wording of [Article 7\(1\)\(f\) EUTMR](#) is very broad and allows a great deal of room for interpretation. A judicious application of this provision necessarily entails balancing the right of traders to freely employ words and images in the signs they wish to register as trade marks against the right of the public not to encounter disturbing, abusive, insulting and even threatening trade marks (06/07/2006, [R 495/2005-G](#), SCREW YOU, § 14).

The rationale of [Article 7\(1\)\(f\) EUTMR](#) is not to identify and filter out signs whose use in commerce must at all costs be prevented, but to preclude trade marks from registration where granting a monopoly would contravene the state of law or would be perceived by the relevant public as going directly against the basic moral norms of society. In other words, the Office should not positively assist people who wish to further their business aims by means of trade marks that offend against certain basic values of civilised society (06/07/2006, [R 495/2005-G](#), SCREW YOU, § 13).

The application of [Article 7\(1\)\(f\) EUTMR](#) is not limited by the principle of freedom of expression (Article 10, Freedom of expression, European Convention on Human Rights) since the refusal to register only means that the sign is not granted protection under trade mark law and does not stop the sign from being used — even in business (09/03/2012, [T-417/10](#), ¡Que bueno ye! HIJOPUTA (fig.), EU:T:2012:120, § 26).

‘Public policy’ and ‘accepted principles of morality’ are two different concepts that often overlap.

The question whether the goods or services for which protection is sought can or cannot be legally offered in a particular Member State’s market is irrelevant for the question as to whether the sign itself falls foul of [Article 7\(1\)\(f\) EUTMR](#) (13/09/2005, [T-140/02](#), Intertops, EU:T:2005:312, § 33). Whether or not a mark is contrary to public policy or accepted principles of morality must be determined by the intrinsic qualities of the mark applied for, and not by the circumstances relating to the conduct of the person applying for the trade mark (13/09/2005, [T-140/02](#), Intertops, EU:T:2005:312, § 28). In its judgment of 20/09/2011, [T-232/10](#), Coat of Arms of the Soviet Union, EU:T:2011:498, the General Court held that the concepts of ‘public policy’ and ‘acceptable principles of morality’ must be interpreted not only with reference to the circumstances common to all Member States but by taking into account ‘the particular circumstances of **individual Member States** which are likely to influence the perception of the relevant public within those States’ (para. 34).

---

<sup>17</sup> Paris Convention for the Protection of Industrial Property of 20 March 1883 (as amended on 28 September 1979).

The legislation and administrative practice of certain Member States can also be taken into account in this context (i.e. for assessing subjective values), not because of their normative value, but as evidence of facts that make it possible to assess the perception of the relevant public in those Member States (20/09/2011, [T-232/10](#), Coat of Arms of the Soviet Union, EU:T:2011:498, § 57). In such a case, the illegality of the EUTM applied for is not the determining factor for the application of [Article 7\(1\)\(f\) EUTMR](#), but rather is of evidential value with regard to the perception of the relevant public in the Member State(s) in question.

Considering that the specific circumstances of **individual** Member States may not be widely known in EU territory, the objection letter should explain these circumstances clearly in order to make sure that the applicant is able to fully understand the reasoning behind the objection and is able to respond accordingly.

## 2 'Public Policy'

### 2.1 Concept and categories

This objection derives from an assessment based on **objective criteria**. 'Public policy' is the body of all legal rules that are necessary for the functioning of a democratic society and the state of law. In the context of [Article 7\(1\)\(f\) EUTMR](#), 'public policy' refers to the **body of EU law applicable in a certain area**, as well as to the legal order and the state of law as defined by the Treaties and secondary EU legislation, which reflect a common understanding of certain basic principles and values, such as human rights.

The following is a non-exhaustive **list of examples** of when signs will be caught by this prohibition.

- Trade marks that contradict the basic principles and fundamental values of the European Union political and social order and, in particular, the universal values on which the European Union is founded, such as human dignity, freedom, equality and solidarity and the principles of democracy and the rule of law, as proclaimed in the Charter of Fundamental Rights of the European Union (OJ C 83, 30/03/2010, p. 389).
- On 27/12/2001, the Council of the European Union adopted Common Position 2001/931/CFSP on the application of specific measures to combat terrorism (OJ L 344, 28/12/2001, p. 93), later updated by Council Decision (CFSP) 2017/1426 of 04/08/2017, updating the list of persons, groups and entities subject to Articles 2, 3 and 4 of Common Position 2001/931/CFSP on the application of specific measures to combat terrorism and repealing Decision (CFSP) 2017/154 (OJ L 204, 05/08/2017, p. 95, consolidated version available at <http://eur-lex.europa.eu/legal-content/EN/TXT/PDF/?uri=CELEX:32017D1426&from=EN>), which contains a list of individuals and groups facilitating, attempting to commit or committing terrorist acts



in EU territory. Any EUTM applied for that can be deemed to support or benefit an individual or a group on the list will be rejected as being against public policy.

### 3 Accepted Principles of Morality

This objection concerns **subjective values**, but these must be applied as objectively as possible by the examiner. The provision excludes registration as European Union trade marks of blasphemous, racist, discriminatory or insulting words or phrases, but only if that meaning is clearly conveyed by the mark applied for in an unambiguous manner; the standard to be applied is that of the reasonable consumer with average sensitivity and tolerance thresholds (09/03/2012, [T-417/10](#), ¡Que bueno ye! HIJOPUTA (fig.), EU:T:2012:120, § 21).

The concept of accepted principles of morality refers to the fundamental moral values and standards to which a society adheres at a given time. Those values and norms are likely to change over time and vary in space (27/02/2020, [C-240/18 P](#), Fack Ju Göhte, EU:C:2020:118, § 39).

The concept of morality in [Article 7\(1\)\(f\) EUTMR](#) is not concerned with bad taste or the protection of individuals' feelings. In order to fall foul of [Article 7\(1\)\(f\) EUTMR](#), a trade mark must be perceived by the relevant public, or at least a significant part of it, as going directly against the fundamental moral values and standards of society.

It is not sufficient if the trade mark is only likely to offend a small minority of exceptionally puritanical citizens. Conversely, a trade mark should not be allowed to be registered simply because it would not offend the equally small minority at the other end of the spectrum who find even gross obscenity acceptable. The trade mark must be assessed by reference to the standards and values of ordinary citizens who fall between those two extremes (06/07/2006, [R 495/2005-G](#), SCREW YOU, § 21).

The examination is to be based on the perception of a reasonable person with average thresholds of sensitivity and tolerance, taking into account the context in which the mark may be encountered and, where appropriate, the particular circumstances of the part of the Union concerned. To that end, elements such as legislation and administrative practices, public opinion and, where appropriate, the way in which the relevant public has reacted in the past to that sign or similar signs, as well as any other factor which may make it possible to assess the perception of that public, are relevant (27/02/2020, [C-240/18 P](#), Fack Ju Göhte, EU:C:2020:118, § 42).

National legislation and practice of Member States are indicators to be taken into account in order to assess how certain categories of signs are perceived by the relevant public in those Member States (20/09/2011, [T-232/10](#), Coat of Arms of the Soviet Union, EU:T:2011:498, § 58). However, the Office must not object to trade marks because of the mere fact that they are in conflict with national legislation and practice. National legislation and practice are considered to be **factual evidence** that enables an assessment of the perception of the relevant public within the relevant territory.

Examples of national legislation taken into account as evidence of a trade mark being contrary to accepted principles of morality:

- use of symbols and names of unconstitutional parties or organisations is prohibited in Germany (§ 86a dt. StGB (German Criminal Code), BGBl. No I 75/1998) and in Austria (§ 1 öst. Abzeichengesetz (Austrian Law on Insignias), BGBl. No 84/1960 in conjunction with § 1 öst. Verbotsgesetz (Austrian Prohibition Law), BGBl. No 25/1947);
- ‘use of symbols of totalitarianism’ (e.g. the sickle and hammer and the five-pointed red star), specifically in a way to offend the dignity of victims of totalitarian regimes and their right to sanctity is prohibited in Hungary (Section 335 of Act C of 2012 on the Criminal Code) (20/09/2011, [T-232/10](#), Coat of Arms of the Soviet Union, EU:T:2011:498).

Signs that can be perceived as promoting the use of illegal drugs also fall under this provision. Taking into account, as factual evidence, that certain drugs are illegal in some Member States as well as the fact that the EU has undertaken drug policy initiatives to fight against illegal drugs, an objection should be raised. It is an objective indication that such signs would be perceived as going directly against the basic moral norms of society.

The assessment made will take into account the term used in the mark applied for or the presence of other elements that could be perceived as promoting the use of illegal drugs. However, an objection will not be raised if the sign contains a reference to a drug that is for medical use, as the mark would not fall, in principle, within the prohibition of [Article 7\(1\)\(f\) EUTMR](#).

The examination of [Article 7\(1\)\(f\) EUTMR](#) should consider the **context** in which the mark is likely to be encountered, assuming normal use of the mark **in connection with the goods and services** covered by the application (06/07/2006, [R 495/2005-G](#), SCREW YOU, § 21). Taking account of the goods and services for which registration of the mark is sought is normally necessary, since the relevant public may be different for different goods and services and, therefore, may have different thresholds with regard to what is clearly unacceptably offensive. For example, ‘a person who is sufficiently interested in [sex toys] to notice the trade marks under which they are sold is unlikely to be offended by a term with crude sexual connotations’ (06/07/2006, [R 495/2005-G](#), SCREW YOU, § 29).

Nevertheless, although the Court has held that the goods and services for which protection is sought are important for identifying the relevant public whose perception needs to be examined, it has also made it clear that the **relevant public is not necessarily only that which buys the goods and services covered by the mark**, since a broader public than just the consumers targeted may encounter the mark (05/10/2011, [T-526/09](#), PAKI, EU:T:2011:564, § 17-18). Accordingly, the commercial context of a mark, in the sense of the public targeted by the goods and services, is not always the determining factor in whether that mark would breach accepted principles of morality (09/03/2012, [T-417/10](#), ¡Que bueno ye! HIJOPUTA (fig.), EU:T:2012:120, § 24; 26/09/2014, [T-266/13](#), Curve, EU:T:2014:836, § 18-19).

**Illegality is not a necessary condition** for giving rise to a conflict with accepted principles of morality: there are words or signs that would not lead to proceedings before the relevant authorities and courts, but that are sufficiently offensive to the general public to not be registered as trade marks (01/09/2011, [R 168/2011-1](#), fucking freezing! by TÜRPIZ (fig.), § 16). Furthermore, there is an interest in ensuring that children and young people, even if they are not the relevant public of the goods and services in question, do not encounter offensive words in shops that are accessible to the general public. Dictionary definitions will in principle provide a preliminary indication as to whether the word in question has an offensive meaning in the relevant language (01/09/2011, [R 168/2011-1](#), fucking freezing! by TÜRPIZ (fig.), § 25), but the key factor must be the perception of the relevant public in the specific context of how and where the goods or services will be encountered.

However, the Boards of Appeal took the view that the word ‘kuro’ did not convey to the Hungarian public the offensive meaning of the word ‘kúró’ (meaning ‘fucker’ in English), since the vowels ‘ó’ and ‘ú’ are separate letters that are distinct from ‘o’ and ‘u’, which are pronounced differently and convey different meanings (22/12/2012, [R 482/2012-1](#), kuro, § 12 et seq.).

There is a clear risk that the wording of [Article 7\(1\)\(f\) EUTMR](#) could be applied subjectively so as to exclude trade marks that are not to the examiner’s personal taste. However, for the word(s) to be objectionable, it (they) must have a clearly offensive impact on people of normal sensitivity (09/03/2012, [T-417/10](#), ¡Que buenu ye! HIJOPUTA (fig.), EU:T:2012:120, § 21).



There is no need to establish that the applicant **wants** to shock or insult the relevant public; the fact that the EUTM applied for **might** be seen, as such, to shock or insult is sufficient (23/10/2009, [R 1805/2007-1](#), PAKI, EU:T:2011:564, § 27, confirmed 05/10/2011, [T-526/09](#), PAKI, EU:T:2011:564, § 20 et seq.).

Finally, it is not only signs with a ‘negative’ connotation that can be offensive. The banal use of some signs with a **highly positive connotation** can also be offensive (e.g. terms with a religious meaning or national symbols with a spiritual and political value, like ‘ATATURK’ for the EU general public of Turkish origin (17/09/2012, [R 2613/2011-2](#), ATATURK, § 31)).

Raising an objection when a trade mark is contrary to accepted principles of morality does not, however, prevent the sign from being also contrary to public policy (e.g. the trade mark may be perceived by the relevant public as directly contrary to the basic moral norms of society and, **at the same time**, may contradict the basic principles and fundamental values of the EU political and social order).

## 4 Examples

### 4.1 Examples of rejected EUTM applications

Sign	Relevant Consumer	Public policy/morality	Case No
BIN LADIN	General consumer	Morality and public policy — the mark applied for will be understood by the general public as the name of the leader of the notorious terrorist organisation Al Qaeda; terrorist crimes are in breach of public order and moral principles (para. 17).	29/09/2004 <a href="#">R 176/2004-2</a>
CURVE	General consumer	Morality — ‘Curve’ is an offensive and vulgar word in Romanian (it means ‘whores’). The relevant public is not limited only to the public to which the goods and services covered by the mark are <b>directly</b> addressed. ‘Curve’ equally offends other persons, who are confronted with the sign <b>accidentally</b> without being interested in these goods and services (para. 19).  With regard to the word ‘Curve’+ additions [‘AIRCURVE’], see example below in this paragraph ( <a href="#">R 203/2014-2</a> ).	<a href="#">T-266/13</a>
	General consumer	Morality — ‘fucking’ is an offensive and vulgar word in English.	<a href="#">R 168/2011-1</a>
	General consumer	Morality — ‘HIJOPUTA’ is an offensive and vulgar word in Spanish.	<a href="#">T-417/10</a>

Sign	Relevant Consumer	Public policy/morality	Case No
	General consumer	Morality — the Hungarian Criminal Code bans certain 'symbols of despotism', including the hammer and sickle as well as the five-pointed red star symbolising the former USSR. This law is not applicable by reason of its normative value but rather as evidence of the perception of the relevant public (paras 59-63) (18).	<a href="#">T-232/10</a>
PAKI	General consumer	Morality — 'PAKI' is a racist insult in English.	<a href="#">T-526/09</a>
SCREW YOU	General consumer (for goods other than sex products)	Morality — a substantial proportion of ordinary citizens in Britain and Ireland would find the words 'SCREW YOU' offensive and objectionable (para. 26).	<a href="#">R 495/2005-G</a>
FICKEN	General consumer	Morality — 'FICKEN' is an offensive and vulgar word in German (it means 'fuck').	14/11/2013, <a href="#">T-52/13</a> , EU:T:2013:596
ATATURK	Average consumer in the EU general public of Turkish origin	Morality — banal use of signs with a highly positive connotation can be offensive under <a href="#">Article 7(1)(f) EUTMR</a> . 'ATATURK' is a national symbol of spiritual and political value for the European general public of Turkish origin.	<a href="#">R 2613/2011-2</a>
FUCK CANCER	General consumer	Morality — the word 'FUCK' is not only a 'slightly rude word' in combination with the word 'CANCER', but offensive and indecent, at least for the English-speaking part of the trade circles (para. 19).	23/02/2015, <a href="#">R 793/2014-2</a>



<sup>18</sup> The Hungarian Criminal Code, in force at the time of the judgment (20/09/2011), has been amended by Act C of 2012 to now encompass 'Use of Symbols of Totalitarianism', used 'specifically in a way to offend the dignity of victims of totalitarian regimes and their right to sanctity' (formerly Section 269/B, now Section 335 of the Hungarian Criminal Code).

Sign	Relevant Consumer	Public policy/morality	Case No
MECHANICAL APARTHEID	General consumer	Public policy — ‘APARTHEID’ refers to an offensive former political regime in South Africa that included state terror, torture and the denial of human dignity. The message conveyed by the sign for computer games, related publications and entertainment is contrary to the European Union’s public policy, since it contradicts the indivisible, universal values on which the EU is founded, i.e. human dignity, freedom, physical integrity, equality and solidarity, and the principles of democracy and the rule of law (para. 30).	06/02/2015, <a href="#">R 2804/2014</a> -5
MH17 MH370	General consumer	Morality — acronyms of the flights. The intent to seek financial gain from what is universally accepted to be a tragic event that has resulted in the loss of many hundreds of lives, is unacceptable and contrary to accepted principles of morality.	EUTM 13 092 937  EUTM 12 839 486

Sign	Relevant Consumer	Public policy/morality	Case No
	<p>General consumer</p>	<p>Public policy and morality — mafia-type organised crime is a clear and present threat to the whole of the EU.</p> <p>'la Mafia' is understood world-wide as referring to a criminal organisation originating in Italy, whose activities extend to States other than the Italian Republic, inter alia, within the European Union. The referred criminal organisation resorts to intimidation, physical violence and murder in carrying out its activities, which include, inter alia, drug trafficking, arms trafficking, money laundering and corruption (para. 35).</p> <p>Such criminal activities breach the very values on which the European Union is founded, in particular the values of respect for human dignity and freedom as laid down in Article 2, Treaty of the European Union and Articles 2, 3 and 6 of the Charter of Fundamental Rights of the European Union (para. 36).</p> <p>The association in the mark of the word element 'la mafia' with the other elements of the contested mark is such to convey a globally positive image of the Mafia's activities and, so doing, to trivialise the perception of the criminal activities of that organisation (para. 46). (...) The contested mark is, therefore, likely to shock or offend not only the victims of that criminal organisation and their families, but also any person who, on EU territory, encounters that mark and has average sensitivity and tolerance thresholds (para. 47).</p>	<p>15/03/2018, <a href="#">T-1/17</a>, EU:T:2018:146</p>

Sign	Relevant Consumer	Public policy/morality	Case No
ETA	General consumer	<p>Public policy and morality — ‘ETA’ will be immediately understood in Europe, in particular in Spain, as designating the terrorist group ETA (para. 2).</p> <p>ETA is included on the list of individuals and groups facilitating, attempting to commit or committing terrorist acts in EU territory (Council Common Position 2001/931/CFSP of 27/12/2001 on the application of specific measures to combat terrorism updated by Council Common Position 2009/64/CFSP) (para. 14).</p> <p>In a commercial context, the term ‘ETA’ has the inherent tendency to shock any normal person who hears or reads it and, in particular, members of the Spanish public who particularly keep that name in mind. The fact that ETA is not currently considered to be the biggest threat facing Spain according to an extract from a survey conducted in June 2015 provided by the applicant, does not mean that the term will not continue to be associated with the terrorist group in question in the mind of the public (para. 15).</p>	27/06/2016, <a href="#">R_563/2016-2</a>
	General consumer	<p>Public policy and morality — the words ‘KRITIKAL BILBO’ identify a variety of plant of the ‘cannabis’ genus — also called ‘marihuana’ — which, due to its high content of tetrahydrocannabinol (THC), namely 21.47 %, is used to make marihuana (para 19).</p> <p>Cannabis with a high THC content is considered to be a narcotic that is prohibited in a large number of Member States (<a href="#">19/11/2009, T-234/06, Cannabis, EU:T:2009:448</a>). Non-psychoactive substances are legal and the authorities can issue licences for their cultivation for those purposes. However, due to its high THC content, in this case the product concerned is not non-psychoactive, but is a substance for smoking that is strictly controlled in almost all European Union countries (para. 22).</p>	27/10/2016, <a href="#">R_1881/2015-1</a>





Sign	Relevant Consumer	Public policy/morality	Case No
	General consumer	Morality — the sign, containing the term 'weed' and applied for in Class 32, will be understood by the relevant consumer as glorifying the use of a drug (cannabis/marijuana) that is prohibited by law in many European countries.	EUTM 16 961 732
IBIZASKUNK	General consumer	Morality — applied for in Classes 5, 31 and 35. The sign, contains the term 'skunk' which refers to a cannabis strain with high THC. It will be perceived as a motivational/promotional message, which encourages an activity prohibited in many Member States of the EU, namely the consumption or sale of products containing SKUNK, as well as a banalisation of the aforementioned narcotic substance. The term IBIZA (known as a party location) reinforces the recreational message.	EUTM 18 97 102
	General consumer	The sign depicts cannabis leaves and also contains the term 'cannabis'. The application was filed for goods in Classes 30 and 32 and for services in Class 43. The Court considered that the fact that the sign would be perceived by the relevant public as an indication that the food and drink items contained narcotic substances, prohibited in many Member States, was sufficient to justify the refusal of the mark. It was not required that a sign encourage or trivialise the use of an illegal narcotic substance.  As regards factors such as the accuracy of the depiction or the intention of the applicant to use the sign only for legal goods, the Court pointed out that the perception of the public was decisive and clarified that the intentions of the applicant did not play a role in the assessment.	EUTM 16 176 968 12/12/2019, <a href="#">T-683/18</a> , EU:T: 2019:855

## 4.2 Examples of accepted EUTM applications

Sign	Relevant Consumer	Comment	Case No
------	-------------------	---------	---------

KURO	General consumer	That a foreign term, name or abbreviation displays certain similarities with an offensive word (like 'kúró') is not in itself sufficient reason to refuse an EUTM application (para. 20). The Hungarian vowels 'ò' and 'ù' are clearly different from the unaccented vowels 'o' and 'u'. Furthermore, Hungarian words never end with an unaccented 'o' (paras 15-18).	<a href="#">R 482/2012-1</a>
SCREW YOU	General consumer (for sex products)	A person entering a sex shop is unlikely to be offended by a trade mark containing crude, sexually charged language (para. 29).	<a href="#">R 495/2005-G</a>
DE PUTA MADRE	General consumer	Although 'puta' means 'whore' in Spanish, the expression 'DE PUTA MADRE' means 'very good' in Spanish (slang).	EUTM 3 798 469 EUTM 4 781 662 EUTM 5 028 477

<p>AIRCURVE</p>	<p>Specialised public (medical personnel; patients with breathing disorders)</p>	<p>The objectionable word ‘Curve’ [‘whore’, ‘slut’ in Romanian] is seamlessly attached to the English word ‘AIR’ to form ‘AIRCURVE’, which, as a whole, is entirely fanciful in Romanian. Even if the relevant public understood the English word ‘AIR’, and analysed the mark by separating it into two elements, the meaning of ‘AIRCURVE’ would be ‘air whores’, which, as a concept, and for respiratory apparatus, is sufficiently nonsensical or puzzling to the extent that it would eclipse any notion of being offensive (para. 13 et seq.).</p> <p>With regard to the word ‘Curve’ on its own, see the abovementioned example in this paragraph (<a href="#">T-266/13</a>).</p>	<p>04/06/2014, <a href="#">R 203/2014-2</a></p>
	<p>General consumer</p>	<p>For the goods at issue — <i>rum</i> (Class 33) — the relevant public will perceive the sign as provocative, transgressive, rebellious, but not as an indicator of criminal origin of the goods (para. 23).</p>	<p>07/05/2015, <a href="#">R 2822/2014-5</a></p>

<p>ILLICIT</p>	<p>General consumer</p>	<p>The mark is considered acceptable under <a href="#">Article 7(1)(f) EUTMR</a>, as 'illicit' is different from something like 'counterfeit'. The mark would be seen as fanciful on the goods (<i>cosmetics, and perfumes</i>) and it could be accepted.</p>	<p>EUTM 13 469 523</p>
	<p>General consumer</p>	<p>The mark evokes a concept that falls within the domain of vulgarity and profanity. However, the effect is attenuated by the fact that the implicit word does not appear in the mark as such. The presence of the initial figurative element 'W', combined with the euphemistic presentation of 'F___', also suppresses the offensive potential of the sign. Consumers with a normal level of sensitivity and tolerance would not be offended or upset by regular commercial exposure to the term in connection with the relevant goods and services in Classes 16, 18, 25, 35, 41, 43 and 44 (para. 31).</p>	<p>29/11/2018 <a href="#">R 1516/2018-5</a></p>

	<p>General consumer</p>	<p>The sign, containing the terms 'hemptouch' and 'cannabis', is applied for in Classes 3 and 5. It will be perceived by the relevant consumer as a reference to the medicinal use of the substance. Hemp is a variety of <i>Cannabis sativa</i>, which contains a very low concentration of THC, and cannabis can be used for medicinal purposes.</p>	<p>EUTM 18 000 042</p>
---	-------------------------	--	------------------------

***GUIDELINES FOR EXAMINATION OF  
EUROPEAN UNION TRADE MARKS***

***EUROPEAN UNION  
INTELLECTUAL PROPERTY OFFICE  
(EUIPO)***

***Part B***

***Examination***

***Section 4***

***Absolute grounds for refusal***

***Chapter 8***

***Deceptive trade marks (Article 7(1)(g)  
EUTMR)***

## Table of Contents

<b>1 The deceptive character.....</b>	<b>561</b>
<b>2 The test for deceptiveness.....</b>	<b>562</b>
2.1 Conveying a <b>specific, clear and unambiguous</b> message in relation to the goods and services.....	562
2.1.1 A mark can be deceptive only when it conveys a clear message regarding the characteristics of the goods and services.....	562
2.1.2 A mark will be deceptive only when the deceptive message relates to the goods and services as they are specified.....	567
2.2 Existence of actual deceit or a sufficient serious risk of deceit.....	568
2.3 Examples of deceptive and non-deceptive trade marks.....	570
<b>3 Categories of deceptiveness.....</b>	<b>578</b>
3.1 Quality and nature of the goods and services.....	578
3.2 Geographical origin of the goods and services.....	579
3.3 Official approval.....	580
<b>4 Relation with other EUTMR provisions.....</b>	<b>582</b>
4.1 Examination: Article 7(1)(b) and (c) EUTMR.....	582
4.2 Cancellation: Article 58(1)(c) and Article 59(1)(a) EUTMR.....	584
4.2.1 Revocation on misleading use (Article 58(1)(c) EUTMR).....	584
4.2.2 Invalidity (Article 59(1)(a) EUTMR).....	585

## 1 The deceptive character

The EUTMR provides protection against deceptive European Union trade marks both as an absolute ground for refusing their registration [[Article 7\(1\)\(g\) EUTMR](#)] and after registration by allowing such marks to be revoked [[Article 58\(1\)\(c\) EUTMR](#)] or declared invalid [[Article 59\(1\)\(a\) EUTMR](#)] upon application of a third party at the Office.-

[Article 7\(1\)\(g\) EUTMR](#) provides that marks that are of such a nature as to deceive the public, for instance, as to the nature, quality or geographical origin of the goods or services, will not be registered. However, this list is not exhaustive and trade marks may be deceptive for other reasons.

In order for a trade mark to be able to fulfil its essential role in the system of undistorted competition, it must offer a guarantee that all the goods or services bearing it have been manufactured or supplied under the control of a single undertaking which is responsible for their quality. A trade mark cannot perform that role, however, where the information it contains is of such a nature as to deceive the public (05/05/2011, [T-41/10](#), *esf école du ski français* (fig.), EU:T:2011:200, § 49-50 and the case-law cited; 27/10/2016, [T-29/16](#), *CAFFÈ NERO*, EU:T:2016:635, § 48; 28/05/2021, [R 406/2021-1](#), *MATE MATE*, § 75).

[Article 7\(1\)\(g\) EUTMR](#) requires the **existence of actual deceit or a sufficiently serious risk that the consumer will be deceived** (29/06/2022, T-306/20, *La Irlandesa*, § 55; 13/05/2020, [T-86/19](#), *BIO-INSECT Shocker*, EU:T:2020:199, § 72; 02/03/2020, [R 1499/2016-G](#), *LA IRLANDESA 1943* (fig.), § 25; 08/06/2017, [C-689/15](#), *Gözze / VVB*, EU:C:2017:434, § 54; 30/03/2006, [C-259/04](#), *Elizabeth Emanuel*, EU:C:2006:215, § 47, and the case-law cited therein).

Taking account of the points above the following two principles are crucial to the practice of the Office in this area.

1. The fact that [Article 7\(1\)\(g\) EUTMR](#) might apply to some goods or services falling within a broader category **does not mean that an objection should be raised** for that category, as there is no inconsistency between the information conveyed by the sign and the category of goods/services applied for. Article 7(1)(g) EUTMR only seeks to prevent the registration of trade marks of such a nature as to deceive the public. Therefore, as long as non-deceptive use of the EUTM is possible for other goods and services within the broader category, the Office will assume good faith on the part of the Applicant (e.g. an EUTM that may be deceptive for *whiskey* will not be objected to for *alcoholic beverages* if it is not deceptive for other goods within that category) (29/06/2022, Case T-306/20, *La irlandesa 1943* (fig.), ECLI:EU:T:2022:404, § 71-72).
2. The relevant public is composed of reasonably well-informed, observant and circumspect individuals meaning that the average consumer is **reasonably attentive** and not particularly vulnerable to deception (01/08/2017, [R 2232/2016-5](#), *Novolimus*, § 17).



## 2 The test for deceptiveness

In accordance with case-law<sup>19</sup>, the Office will object on the grounds of deceptiveness where two cumulative criteria are met:

- The relevant public **recognises the sign as conveying a specific, clear and unambiguous message** regarding the nature, quality or geographical origin (or other characteristic) of goods and services worded in such a manner that non-deceptive use is impossible.
- The relevant public might rely on that message and purchase goods or services in the mistaken belief that they possess a certain characteristic they cannot have (i.e. there is **actual deceit or a sufficiently serious risk of being deceived**).

### 2.1 Conveying a specific, clear and unambiguous message in relation to the goods and services

#### 2.1.1 A mark can be deceptive only when it conveys a clear message regarding the characteristics of the goods and services

Deceptiveness is assessed on the basis of **all of the possible perceptions** of the mark by the relevant consumer.

For example, the sign 'CAFFÈ NERO' could be perceived by Italian speakers as referring to (i) black coffee (i.e. coffee served as a beverage without cream, milk or sugar) or (ii) a coffee house with the name 'NERO'. Both meanings are relevant<sup>20</sup>.

If the mark is deceptive **under one of the possible perceptions**, it will be objected to pursuant to [Article 7\(1\)\(g\) EUTMR](#). It is irrelevant that the consumer might not be deceived by an alternative perception of the sign (13/05/2020, [T-86/19](#), Bio-insect shocker, EU:T:2020:199, § 84-85; 27/10/2016, [T-29/16](#), CAFFÈ NERO, EU:T:2016:635, § 48-49).

If the sign does not convey any clear message regarding the characteristics of the goods and services, then it will not be sufficiently specific to be deceptive (24/09/2008, [T-248/05](#), I.T.@Manpower, EU:T:2008:396, § 65 & 66; 29/11/2018, [T-681/17](#), KHADI / KHADI, EU:T:2018:858; § 53). For instance, a **mere calling to mind** of something connected with the goods and services or at the very most **hints** at them, or **influencing the imagination** of the public, are also **not sufficient** to establish

<sup>19</sup> See in particular 26/11/1996, [C-313/94](#), Graffione [1996] ECR I-6039, § 24; 04/03/1999, [C-87/97](#), Cambozola, EU:C:1999:115, § 41-43; 30/03/2006, [C-259/04](#), Elizabeth Emanuel, EU:C:2006:215; § 47; 08/06/2017, [C-689/15](#), Gözze / VVB (Cotton Flower), EU:C:2017:434, § 54-57. The GC provided further elaboration on the test at 27/10/2016, [T-29/16](#), CAFFÈ NERO, EU:T:2016:635, § 45 and [T-37/16](#), CAFFÈ NERO (fig.), EU:T:2016:634.

<sup>20</sup> As opposed to 'CAFFÈ', the term 'COFFEE' (in English) only refers to the beverage. The mark 'RALPH'S COFFEE' would be perceived by English speakers as referring only to the beverage ('coffee'), together with the first name 'Ralph', whereas the expression 'RALPH'S CAFE' would be perceived as an establishment selling beverages and meals (16/08/2019, [R 883/2019-2](#), Ralph's coffee, § 15).

deception (24/09/2008, [T-248/05](#) , I.T.@Manpower, EU:T:2008:396, § 67-68; 27/06/2017, [T-327/16](#) , ANTICO CASALE, EU:T:2017:439, § 51).

The mere presence of an element that could, on its own, convey a deceptive meaning is not enough to conclude that the sign conveys a deceptive meaning since it is the perception of the sign **as a whole** that matters. In order to determine whether an element in the sign conveys a clear message to the consumer, **account must be taken of all the other elements of the sign** , as these are **likely to influence the outcome of the assessment** .



In principle, a sign **will not be considered** as clearly conveying a message indicating a characteristic of the goods and services if:

1. the combination of the ‘deceptive’ element with additional elements pinpoint a business or establishment rather than convey a message about a good or service or their characteristics;
2. the sign contains a conceptual meaning/message that precludes the element from being perceived in a deceptive way;
3. the sign’s combination of elements creates a logical and conceptual unit that should not be artificially dissected;
4. the sign contains a reference to various goods and/or services and, therefore, will not be perceived as an indication regarding specific goods and services.

**Table 2: Examples of non-deceptive trade marks**

**(as a whole the sign does not convey specific information regarding the good(s) at stake)**

EUTM No	Descriptive element	Goods applied for in Class 30	Reasoning
18 200 410	Coffee	<i>Coffee; sugar; mustard; vinegar; malt biscuits; foodstuffs made from cereals; preparations made from cereals; salts, seasonings, flavourings and condiments; rice; sago; herbal infusions; prepared coffee beverages.</i>	The term <i>COFFEE HOUSE</i> in the sign refers to <b>a particular establishment in which coffee and other beverages would be provided</b> ; the sign would therefore not be seen as deceptive for goods such as <i>herbal infusions</i> which consumers would expect to be available in such an establishment.

<p>18 536 976</p> 	Coffee	<p>Inter alia , <i>coffee; decaffeinated coffee; artificial coffee; coffee concentrates; coffee extracts; iced coffee; chicory [coffee substitute]; sugar-coated coffee beans; coffee, teas and cocoa and substitutes thereof.</i></p>	<p>The term <i>coffee n' bites</i> in the mark shows that coffee will not be the only product protected by the mark. The mark gives the impression of a place serving various things. It can therefore be accepted for goods that are not coffee, such as <i>artificial coffee and teas and cocoa and substitutes thereof</i> .</p>
<p>18 229 978</p> 	Coffee	<p>Inter alia, <i>coffee; tea; cocoa; artificial coffee; rice; tapioca and sago; flour and preparations made from cereals; edible ices; sugar; honey; golden syrup; seasonings; ice [frozen water]; chocolate; coffee-based beverages; chocolate and tea-based beverages; chocolate-coated nuts; drinking chocolate; cocoa-based beverages; coffee flavourings; coffee beverages with milk; coffee-based beverages.</i></p>	<p>A consumer would not expect a mark that combined the element 'COFFEE' with the elements 'SWEET' and 'SNACK' to only offer coffee.</p>
<p>18 594 185</p> <p><b>Longevitea</b></p>	Tea	<p><i>Coffee, teas and cocoa and substitutes thereof.</i></p>	<p>The allusion to longevity with the misspelling <b>creates a unit which should not be dissected</b> . The letters -<i>tea</i> at the end are therefore not deceptive for goods which are not <i>tea</i> .</p>

In principle, a sign **will be considered** as clearly conveying a message indicating a characteristic of the goods and services if:

- the ‘deceptive’ element is either visually highlighted or separated from the other elements of the sign, and not linked to another logical and conceptual unit of the sign; or
- the overall sign, as a logical and conceptual unit, reinforces the perception of the ‘deceptive’ element (the other elements are perceived as mere qualifiers of the descriptive term - colour, size, etc. - or are a graphic representation of the descriptive term).

**Table 3: Example of deceptive trade marks**

**(as a whole the sign conveys specific information regarding the good(s) at stake)**

EUTM No	Descriptive element	Goods applied for in Class 30	Reasoning

<p>18 159 174</p>  <p>The logo features a circular emblem with a ship's mast and the text 'Dolce Bacio' and 'perché rimane sempre'. Below the emblem is a ribbon with the text 'FLAVORED COFFEE'.</p>	<p>Coffee</p>	<p>Inter alia, <i>coffee, tea, cocoa and artificial coffee; coffee substitutes (cereal or chicory based); beverages based on coffee, cocoa, chocolate or tea.</i></p>	<p>The element 'FLAVORED COFFEE' is separated from the other elements in the sign. The decorative brown and beige ribbon, which contains the words 'FLAVORED COFFEE', visually highlights the verbal element. Therefore, the sign is likely to deceive the relevant public in relation to: <i>artificial tea, cocoa and coffee; Coffee substitutes (based on cereals or chicory); beverages based on cocoa, chocolate or tea</i> are or contain coffee.</p> <p>A limitation was made to exclude: <i>artificial tea, cocoa and coffee; coffee substitutes (based on cereals or chicory); beverages based on cocoa, chocolate or tea.</i></p> <p>Registered for <i>Coffee; coffee-based beverages</i>.</p>
--	---------------	---	--

<p>18 093 546</p> 	Coffee	Inter alia <i>coffee, teas and cocoa and substitutes thereof.</i>	<p>The element 'COFFEE' is clearly visually separated from the other elements in the sign. Therefore, the sign is likely to deceive with respect to <i>tea and cocoa and substitute thereof</i> since these goods neither are nor contain coffee.</p> <p>Registered for: coffee; partially refused for: <i>teas and cocoa and substitutes thereof.</i></p>
---	--------	---	--

### 2.1.2 A mark will be deceptive only when the deceptive message relates to the goods and services as they are specified

When the sign conveys a specific, clear and unambiguous message, it must be assessed in relation to the exact manner in which the goods and services are specified. If the message could be deceptive for specific goods and services within a category, this will not result in an objection if the message is not deceptive for other goods and services in the category.

- If **non-deceptive use of the mark is possible** for the goods and services as specified, the mark is not deceptive.

When **broad categories** are used in the list of goods/services, the Office does **not object** where the mark could be deceptive **for only some of the goods/services falling within the categories**.

For example, the Office would not raise an objection on deceptiveness for the mark JAPAN WHITE in relation to *rice*. It is irrelevant that *rice* includes brown rice (on which the mark would be deceptive) because white rice is also included (and use would not be deceptive for these goods). The Office assumes that the mark will be used in a non-deceptive manner and the mere fact that a broad category is used does not represent a sufficiently serious risk of deception once non-deceptive use is possible (30/03/2006, [C-259/04](#), Elizabeth Emanuel, EU:C:2006:215, § 47).

Article 7(1)(g) EUTMR only seeks to prevent the registration of trade marks of such a nature as to deceive the public, and there is no reason for the Office to presume that the mark will be used in a deceptive manner.

Therefore, when there is no inconsistency between the information conveyed by the sign and the goods/services applied for, the **specification does not need to be**

**limited** to any particular quality linked to the message transmitted by the sign, such as their geographical origin, because any such characteristic of the designated goods/services is covered by the list, and **non-deceptive use of the mark is possible** (29/06/2022, Case T-306/20, La irlandesa 1943 (fig.), ECLI:EU:T:2022:404, § 71-72).

- If **non-deceptive use of the trade mark is impossible** for the goods/services as applied for, the mark will be found deceptive.

For example, an objection should be raised against the trade mark



filed for, inter alia, *still waters*, for which non-deceptive use is not possible. The word 'soda' would create a clear expectation of a carbonated drink, which *still waters* obviously are not (21/11/2017, [R 1636/2017-2](#), EASY SODA (fig.), § 19).

The trade mark JAPAN WHITE for *rice; husked rice; brown rice; polished rice; cereal preparations* describes characteristics of the goods at issue, namely that they originate from Japan and they are white in colour. Non-deceptive use is impossible for *brown rice* as there is a clear contradiction between the message conveyed by the mark and the nature and colour of the good at issue ('which can never be white') (20/03/2018, [R 694/2017-1](#), JAPAN WHITE, § 52, 54).

## 2.2 Existence of actual deceit or a sufficient serious risk of deceit

Where a sign conveys a specific, clear and unambiguous message that is incongruent with the goods and services specified in the application, this per se is not enough for it to pose a sufficiently serious risk of deception under Article 7(1)(g) EUTMR. For there to be a risk of deception, it would also need to be likely that the consumer would rely on the message in the sign and be deceived into purchasing the goods or services, in the mistaken belief that they possess a characteristic indicated but **which they cannot have**.

Refusing registration on the grounds of deceptiveness, therefore, 'presuppose[s] the existence of actual deceit or a sufficiently serious risk that the consumer will be deceived' (04/03/1999, [C-87/97](#), Cambozola, EU:C:1999:115, § 41; 30/03/2006, [C-259/04](#), Elizabeth Emanuel, EU:C:2006:215, § 47, 48-49; 27/10/2016, [T-29/16](#),

CAFFÈ NERO, EU:T:2016:635, § 45; invalidity 08/06/2017, [C-689/15](#), Gözze / VVB (Cotton Flower), EU:C:2017:434, § 54, 56-57).

The threshold for applying [Article 7\(1\)\(g\) EUTMR](#) must not be set too low as the relevant public normally comprises reasonably well-informed, observant and circumspect individuals, and the average consumer is usually reasonably attentive and not highly vulnerable to deception.

In the Elizabeth Emanuel case, the Court made a distinction between when consumers are simply influenced by a trade mark in a misleading way, and when **the consumer is actually (or could reasonably be) deceived by the sign**. Only when the latter happens can the grounds for objection be raised.

When evaluating this, the Office will take into account the **characteristics of the goods and services** at issue together with **market reality** and **consumer** habits and perceptions.

When assessing the risk of deceptiveness in relation to **market reality and consumer habits and perceptions**, the following can be considered:

- The **place** where the goods are normally displayed for sale

The risk of deceptiveness is higher when the **goods are placed next to each other**. For example, this is usually the case with beer and cider, whereas wines would generally be on display in a specific and easily recognisable section of a shop. Another example would be product substitutes such as vegetarian and non-vegetarian foodstuffs, which are to be found **directly alongside one another** in the (refrigerated) shelves of a supermarket.

- The **packaging** of the goods

Packaging is usually **linked to the nature of the goods** themselves and can therefore play a role in the risk of deceit towards the consumer. Similar packaging can increase the risk of deceptiveness whereas different packaging can exclude it (e.g. liquid vs solid goods, transparent vs non-transparent packaging).

- The **price**

A large price difference between goods can help to exclude deception as the reasonably observant consumer will be aware of the price range of relevant goods. For example, for *water* and *spirit drinks*, the significant price difference is likely to rule out any serious risk of being deceived into purchasing one in the belief that it is the other. Consequently, a mark on whiskey containing the message 'water of life' (which translates the Irish 'uisce beatha' for whiskey [and from which the term 'whiskey' is derived]) will not result in consumers buying whiskey in the belief that it is water. The price differential alone would rule this out (as well as other factors).

- **New products and marketing strategies**

The Office must take account of developments in the market such as the mixing of new flavours: water and aromatised water, coffee containing cocoa, etc.

- **Level of attention of the consumer**



For common/everyday goods, the degree of attention of the consumer is lower than for less common goods, and the risk of deceit is higher.

For example, foodstuffs are purchased on a daily basis in the supermarket and the consumer's attention with regard to these foodstuffs is not high (08/06/2020, [R 2/2020-5](#), NEXT LEVEL MEAT, § 20, 29).

As consistently pointed out by case-law, common goods such as coffee, tea, mate, cocoa and artificial coffee are all sold in **packaging that is very similar**, and as the consumer's level of attention is not high, they often buy these goods more hastily and quickly, without necessarily taking the time to analyse the wording on the packaging. It is therefore likely that consumers will pick (these) common goods from the shelf in the mistaken assumption that they are or contain the product indicated by the sign: coffee, tea, mate, cocoa or artificial coffee (27/10/2016, [T-29/16](#), CAFFÈ NERO, EU:T:2016:635, § 45; 26/10/2017, [T-844/16](#), Klosterstoff, EU:T:2017:759, § 45; 16/08/2019, [R 883/2019-2](#), Ralph's coffee, § 13; 28/05/2021, [R 406/2021-1](#), MATE MATE, § 77).

## 2.3 Examples of deceptive and non-deceptive trade marks

The following are examples of marks that were found to be **deceptive** with regard to all or part of the goods for which protection was sought.

### Deceptive marks <sup>(21)</sup>

Sign and goods	Reasoning	Case No
LACTOFREE For <i>lactose</i> in Class 5.	The nature of the sign would immediately lead the relevant consumer to believe that the product in question, that is, 'lactose', does not contain any lactose. It is clear that if the product being marketed under the sign 'LACTOFREE' were actually <i>lactose</i> itself, then the mark would be clearly misleading.	19/11/2009, <a href="#">R 892/2009-1</a>

<sup>21</sup> These examples only address the issue of whether an objection based on deception should be raised or not. This paragraph does not deal with possible objections under other absolute grounds for refusal. Therefore, the possibility that a given trade mark might appear to be *prima facie* objectionable under [Article 7\(1\)\(b\) and/or \(c\) EUTMR](#) (or any other provisions) is not contemplated here.

<p>FLEXSTEEL <sup>(22)</sup></p> <p><i>For pipes, tubes and hoses, and fittings therefor, including valves, of metal; flexible tubes of metal; metal hose clamps; hose hangers of metal; metal hose fittings; reels, not of metal, non-mechanical, for flexible hoses in Class 6.</i></p> <p><i>For flexible pipes, tubes, hoses, and fittings therefor, including valves, non-metallic; non-metallic connectors for hoses; non-metallic couplings for tubes; non-metallic elbow joints for flexible pipes; non-metallic sealing rings for hose fittings in Class 17.</i></p>	<p>Insofar as the public targeted will understand the sign literally as a descriptive indication, namely that the goods thus identified consist of steel or at least contain a substantial proportion of steel, the sign is capable of deceiving the public as to the nature of the goods applied for in Class 17. For these goods, namely <i>flexible pipes, tubes, hoses, and fittings therefor, including valves, non-metallic; non-metallic connectors for hoses; non-metallic couplings for tubes; non-metallic elbow joints for flexible pipes; non-metallic sealing rings for hose fittings</i>, the use of metal and thus also steel is ruled out.</p>	<p>09/12/2016, <a href="#">R 1360/2016-4</a></p>
---	--	--

<sup>22</sup> See prior decision on the same line of reasoning: 23/01/2002, [R 789/2001-3](#), TITAN (German word for 'titanium') for portable and relocatable buildings; modular portable building units for use in the construction of prefabricated relocatable buildings; prefabricated relocatable buildings constructed of modular portable building units, none of the aforesaid goods being made from or including titanium in Classes 6 and 19. During the appeal proceedings, the applicant – in an attempt to overcome an objection based on deception – offered to restrict the specifications in both classes by adding, at the end, the indication that none of the aforesaid goods were made from or included titanium. The Board held that such a restriction, if accepted, would have had the effect of rendering the trade mark deceptive from the standpoint of the German-speaking public, as they would assume that the goods were made from titanium when in reality this is not the case.

<p>Bio-insect shocker</p> <p>For <i>biocidal preparations for use in manufacture</i> in Class 1 and <i>biocides</i> in Class 5.</p>	<p>The prefix 'Bio' refers to the idea of environmental protection, the use of natural materials or even ecological manufacturing processes; it gives the impression that the products are natural, do not harm health and are environmentally friendly. This is a quality that biocidal products can not have by definition. This is supported by the specific Regulation regarding biocidal products (Regulation No 528/2012). Therefore the mark was considered to be deceptive for <i>biocidal preparations for use in manufacture</i> in Class 1 and <i>biocides</i> in Class 5.</p>	<p>13/05/2020</p> <p><a href="#">T-86/19</a></p>
 <p><b>Buffalo beef</b></p> <p>For <i>beef, veal, poultry, game</i> in Class 29.</p>	<p>(...) there is a reasonable risk that the relevant public might purchase meat packaging under the contested trade mark 'BUFFALO BEEF' in a supermarket, with a reasonable belief that buffalo or bison meat is being purchased, whereas beef, veal, poultry or game would be found inside the packaging (para. 70).</p>	<p>14/05/2021</p> <p><a href="#">R 2082/2020-5</a></p>

<p><b>Cryobiostorage</b></p> <p>For <i>various apparatus and installations for heating purposes</i> in Class 11.</p>	<p>The component 'cryo' will be understood as a modifier in combinations meaning cold or frost.</p> <p>The goods for which protection is sought do not have a cooling, but rather a heating effect. It cannot therefore be ruled out that the target public will be deceived as to the purpose and intended purpose of these goods, that is, it expects a refrigerating apparatus, but receives the exact opposite. (...) (para. 47).</p>	<p>26/03/2021</p> <p><a href="#">R 1617/2020-2</a></p>
--	---	--

<p><b>NATUR.VINYL</b></p> <p>For <i>various metal building materials, small items of metal hardware</i> in Class 6, and <i>wood for building purposes, floor boards of wood, leather and/or other materials, not of metal</i> in Class 19.</p>	<p>(...) the goods do not consist explicitly of nature imitating vinyl. However, vinyl is used in many places and imitates various materials very well, for example, wood and metal. Therefore, it is entirely conceivable that a reasonably well-informed, observant and circumspect consumer will be deceived by the actual composition of the goods marketed under the sign. In applying the sign to goods made of other materials, such as wood, leather or metal, there is a sufficiently serious risk that the sign in question (...) will let consumers assume that they are purchasing goods made of pure/high-quality vinyl instead of, for example, wood or metal. It can also be true that consumers will purchase the goods sold under the sign only because they expect characteristics of vinyl, for example, lightness, elasticity, which goods made of wood or metal do not have at all (para. 51).</p>	<p>26/03/2021</p> <p><a href="#">R 103/2019-2</a></p>
<p><b>Just egg</b></p> <p>For <i>plant-based egg substitute; liquid egg substitute; plant-based processed food</i> in Class 29.</p>	<p>At least a significant part of the English-speaking general public will erroneously assume that the foodstuffs are or contain only eggs, or are based on eggs (of domestic hens), which is clearly not the case. The sign is therefore capable of deceiving the public about the nature of the foodstuffs at issue, given the meaning of the contested sign (paras 30-31).</p>	<p>14/02/2022</p> <p><a href="#">R 1425/2021-5</a></p>

<p><b>Veggiemett</b></p> <p>For <i>meat, fish, poultry and game, in particular sausage and ham products; meat extracts</i> in Class 29.</p>	<p>For the German-speaking public, ‘Veggie’ is understood as an indication of purely vegetable ingredients, or purely vegetable origin, and ‘mett’ is understood as a meat product consisting specifically of mince. The overall message of the sign is meat-free variants of the food product <i>mett</i>, which traditionally consists of mince, meat, fish, poultry, game or meat extracts. A German-speaking consumer could erroneously assume that it involves a vegetarian foodstuff. (paras 20-22, 45).</p>	<p>26/09/2016</p> <p><a href="#">R 2270/2015-5</a></p>
---	--	--

The following are examples of marks that were found **not to be deceptive** with regard to all or part of the goods for which protection was sought:

**Non-deceptive marks**

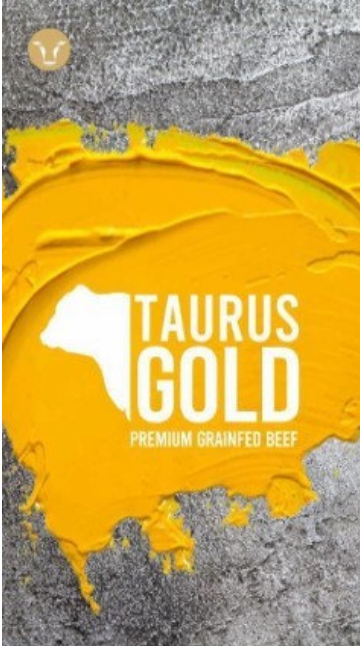
Sign and goods	Reasoning	Case No
 <p>The logo features a yellow circular shape resembling a splash of paint on a grey, textured background. Inside the yellow shape is a white silhouette of the African continent. To the right of the silhouette, the words 'TAURUS GOLD' are written in bold, white, sans-serif capital letters. Below this, in smaller white capital letters, is 'PREMIUM GRAINFED BEEF'. A small yellow circle with a white 'TV' logo is visible in the top left corner of the image.</p> <p>For <i>meat</i> in Class 29.</p>	<p>The specification is sufficiently broad to include beef. There is no specific reference in the sign, which indeed would qualify for an objection under <a href="#">Article 7(1)(g) EUTMR</a>.</p>	<p>EUTM No 18 553 925</p>

 <p>For tea-based beverages, cocoa powder in Class 30.</p>	<p>The combination of 'Urban' and 'Coffee' creates a logical and conceptual unit that should not be artificially dissected. The Board pointed out that 'Urban Coffee' is not 'coffee', but 'urban coffee'. 'There is no such thing as an 'urban (urban) coffee'. The sign applied for could therefore not reasonably be understood to promise an 'Urban coffee' with certain (positive) characteristics (§ 10) and, it is assumed that the consumers would understand the sign 'COBEA URBAN COFFEE' as the umbrella mark for a provider specialising in coffee and this would easily also result in other goods being offered for sale, whether it to take away (in railway kiosks), be it in the supermarket shelf' (§ 13).</p>	<p>10/11/2020, <a href="#">R 1273/2020-4</a></p>
---	--	--

 <p>For, <i>inter alia</i>, processed fungi and pulses in Class 29.</p>	<p>The verbal elements of the sign read in Romanian: '<i>Romanian tomatoes DRACULA</i>'. The component 'Romanian tomatoes' is meaningful and conveys a direct message: <b>tomatoes originating from Romania</b>. The term 'DRACULA', despite its size and central position, would by itself not lead away from the descriptive message as neither pinpoints a business nor conveys a conceptual message which would dilute the meaning.</p> <p>The risk of deceit is excluded, however, as the consumer will be assisted by either the direct visualisation of the product (in this case <i>processed fungi and pulses</i>) or by a photo or a graphic representation of the specific foodstuff (<i>processed fungi and pulses</i> in non-transparent packaging). Normally non-transparent packaging will include a picture or a graphic representation of the specific product (foodstuff).</p>	<p>EUTM No 18 496 748</p>
--	--	---------------------------



	<p>The sign merely calls into mind the descriptive element 'chocolate', which is not fully displayed in the sign applied for.</p>	<p>EUTM No 18 595 383</p>
<p><i>For coffee, tea, cocoa, sugar, rice, tapioca, sago, coffee substitutes; cocoa-based beverages; coffee-based beverages; coffee-based beverage containing milk; coffee-based beverages containing ice cream (affogato); chocolate-based beverages; tea-based beverages; coffee beverages with milk; chocolate-based beverages; chocolate beverages with milk; cocoa and cocoa-based beverages; cocoa; cocoa powder; cocoa beverages with milk; instant cocoa powder in Class 30.</i></p>		

### 3 Categories of deceptiveness

Trade marks may be deceptive under different circumstances, as the list included in [Article 7\(1\)\(g\) EUTMR](#) (nature, quality or geographical origin of the goods or services) is not exhaustive. Different categories of deceptiveness can be established in relation to the goods and services, and, in particular, the following: quality and nature, geographical origin and official approval.

#### 3.1 Quality and nature of the goods and services

These two categories are listed under Article 7(1)(g) EUTMR, but they often overlap and the distinction has little practical significance (see examples of this category of deceptiveness under Section 2).

### 3.2 Geographical origin of the goods and services

The Office will not raise an objection on the grounds of deception based upon the applicant's geographical location (address) because it bears no relation to the geographical origin of the goods and services, that is to say, the actual place of production/offering of the goods and services covered by the mark.

For example, under [Article 7\(1\)\(g\) EUTMR](#), the Office will not object to a figurative mark containing the words **MADE IN USA** for *clothing* in Class 25 that is filed by a company with its seat in Sweden. In such cases, the Office makes no link between the address of the applicant and the provenance of the goods.

Deception would nonetheless arise in the hypothetical case of a figurative mark containing the words **MADE IN USA, for a specifically limited list of goods — for example, clothing articles made in Vietnam.**

The sign could evoke in the consumers' minds some impressions/expectations as to the geographical origin of the goods or of their designer that may not correspond to reality. For example, trade marks such as **ALESSANDRO PERETTI** or **GIUSEPPE LANARO** (invented examples) covering clothing or fashion goods in general may suggest to the relevant public that these goods are designed and produced by an Italian stylist, which may not be the case.

However, such a circumstance is not sufficient per se to render those marks misleading for non-Italian goods. Indeed, when the sign is merely evocative there is no clear contrast between the impression/expectation a sign may evoke and the characteristics/qualities of the goods and services it covers.

The following are two **examples** where the marks concerned were **not found to be deceptive**, particularly as regards the geographical origin of the goods and services.

Sign and services	Reasoning	Case No
<p><b>Port Charlotte</b></p> <p>For <i>whisky</i> in Class 33.</p> <p>Registration for the trade mark was originally sought for 'alcoholic beverages' but pursuant to the invalidity action, the list was limited to only '<i>whisky</i>'.</p>	<p>The GC confirmed that the word mark 'Port Charlotte' was not deceptive regarding the origin of the goods (whisky) as <b>it did not designate a geographical region</b>. The GC held that 'Port Charlotte' <b>read as a whole and as a logical and conceptual unit</b>, would be understood as a harbour named after a person, without any direct link to the PDO 'Porto' or 'port' or a port wine (§ 71).</p>	<p>18/11/2015, <a href="#">T-659/14</a>, PORT CHARLOTTE, EU:T:2015:863</p> <p>The judgment was appealed before the CJEU (14/09/2017, <a href="#">C-56/16 P</a>, PORT CHARLOTTE, EU:C:2017:693), but the grounds of deceptiveness were not examined.</p>

<p><b>Antico Casale</b> For Classes 29, 30 and 35.</p>	<p>The GC underlined once again that for a trade mark to be deceptive with regard to the geographical origin of the goods or services, <b>it is necessary that the targeted public recognises the sign as a reference to a place or, indeed, to a geographical origin.</b> In the case at stake, the (Italian) consumer would not understand the sign Antico Casale as referring to a geographical origin or a specific place, since the mark does not convey a clear message about the goods, and is not likely to create unrealistic expectations in the mind of the consumers that the specified products only originate from an old farmhouse (§ 49; Case R 1337/2015-2, § 61-63). At the very most, it only gives a hint at them - that is not alone sufficient to deceive the public (§ 51, quoting Manpower).</p>	<p>27/06/2017, <a href="#">T-327/16</a>, ANTICO CASALE, EU:T:2017:439.</p>
--	--	--

### 3.3 Official approval

Under the practice of the Office, trade marks that could evoke official approval, status or recognition **without giving the firm impression** that the goods/services issue from, or are endorsed by, a public body or statutory organisation, are acceptable.

The following are three examples where the marks concerned, although allusive or suggestive, were **not found** to be **deceptive**.

Sign and Services	Reasoning	Case No
-------------------	-----------	---------

<p><b>THE E-COMMERCE AUTHORITY</b></p> <p>For <i>business services, namely, providing rankings of and other information regarding electronic commerce vendors, goods and services via the Internet</i> in Class 35 and <i>providing research and advisory services and information in the area of electronic commerce</i> in Class 42.</p>	<p>The Board found that the trade mark was not deceptive, as it did not convey the firm impression that the services issue from a governmental or statutory organisation. (The Board, however, confirmed the refusal under <a href="#">Article 7(1)(b) EUTMR</a> on the grounds that the mark lacked distinctive character, as it would be perceived by the English-speaking public merely as a simple statement of self-promotion that makes a claim about the level of competence of the service providers.)</p>	<p>11/07/2001, <a href="#">R 803/2000-1</a></p>
 <p>For, inter alia, <i>teaching of skiing</i> in Class 41.</p>	<p>The Board held that French consumers would understand that the trade mark alludes to the fact that the services are supplied in France by a French teaching centre, and relate to learning how to ski 'in the French way'. Furthermore, the French public had no reason to believe that, simply because of the presence of its tricolour logo (not a reproduction of the French flag), that the services are supplied by public authorities or even authorised by such authorities.</p>	<p>11/11/2009, <a href="#">R 235/2009-1</a>; confirmed 05/05/2011, <a href="#">T-41/10</a>, EU:T:2011:200</p>

<p>TSA LOCK</p> <p>For, inter alia, <i>metal locks for luggage</i> in Class 6, and <i>non-metal locks for luggage</i> in Class 20.</p>	<p>The applicant claimed that since TSA stands for ‘Transportation Security Administration’ this would make the relevant public believe the goods offered under the contested mark were supplied by the US organisation or at least were under their control (§ 58). The GC held that the applicant had not established by any means of evidence that the relevant public associated, at the relevant date, this being the date of filing the application, the letters ‘TSA’ in the contested mark with the American Transportation Administration. In such case, there can be no deception (§ 64).</p>	<p>22/03/2018, <a href="#">T-60/17</a>, TSA LOCK, EU:T:2018:164</p>
--	---	---

## 4 Relation with other EUTMR provisions

### 4.1 Examination: Article 7(1)(b) and (c) EUTMR

As each ground is assessed on its own merits and according to each of the goods and services applied for, an objection can be based on both descriptiveness / lack of distinctiveness and deceptiveness.

Sign and services	Reasoning	Case No
-------------------	-----------	---------

<p>JAPAN WHITE</p> <p><i>For rice; husked rice; brown rice; polished rice; cereal preparations</i> in Class 30.</p>	<p>The Board confirmed that when used with respect to the goods at issue, the sign 'JAPAN WHITE' as a whole, immediately informs consumers, without further reflection, that the goods at issue (rice, cereals) 'originate from Japan AND are of white colour'.</p> <p>It concluded that the mark as a whole was <b>descriptive</b> with respect to the goods applied for (except <i>brown rice</i>) and <b>deceptive</b> in connection with <i>brown rice</i>.</p>	<p>20/03/2018, <a href="#">R 694/2017-1</a>, JAPAN WHITE</p>
---	---	--

Furthermore, when, in the course of proceedings, an EUTM applicant proposes a limitation, for example in an attempt to overcome an objection on descriptiveness, lack of distinctiveness or conflict with a GI, the Office will implement the requested limitation, and make sure that the mark has not become deceptive as a consequence of this limitation (for more information on the restriction of goods and services giving rise to a new ground for refusal see Section 4 Absolute grounds for refusal — Chapter 1 General principles, Restrictions of goods and services -[2 Dialogue with the Applicant](#)).

An originally broad category of goods and services might, after restriction, be specified in such a way as to be objected to under [Article 7\(1\)\(g\) EUTMR](#), even though it was not originally objectionable under this ground.

Sign and services	Reasoning	Case No
-------------------	-----------	---------

<p>ARCADIA</p> <p>Originally applied for <i>wines, spirits (beverages) and liqueurs</i> in Class 33.</p>	<p>The Office, objected under <a href="#">Article 7(1)(c) EUTMR</a> because the trade mark was descriptive of the geographical origin of wines, to the extent that Arcadia is a Greek region known for its wine production. The applicant offered to limit the specification of goods to exclude <i>wines made in Greece</i>, or to include only <i>wines produced in Italy</i>. The Office held that the proposed limitation would render the trade mark deceptive under <a href="#">Article 7(1)(g) EUTMR</a>, since it would convey false information as to the origin of the goods.</p> <p>The mark was refused.</p>	<p>27/03/2000, <a href="#">R 246/1999-1</a>, ARCADIA, § 14</p>
--	--	--

## 4.2 Cancellation: Article 58(1)(c) and Article 59(1)(a) EUTMR

The test of deceptiveness is considered *prima facie* to be the same in examination, and in some post registration actions, namely revocation on misleading use ([4.2.1 Revocation on misleading use \(Article 58\(1\)\(c\) EUTMR\)](#)) and invalidity based on absolute grounds ([4.2.2 Invalidity \(Article 59\(1\)\(a\) EUTMR\)](#)).

However, the scope of the assessment of cancellation proceedings is **limited to the legal arguments and factual submissions** presented by the applicant of the revocation or invalidity proceeding, also taking into consideration well-known facts.

For further information regarding cancellation, please see the Guidelines [Part D, Cancellation](#).

### 4.2.1 Revocation on misleading use (Article 58(1)(c) EUTMR)

[Article 58\(1\)\(c\) EUTMR](#) does not contain any reference to [Article 7\(1\) EUTMR](#) but it stipulates that if, in consequence of the use made of the trade mark in respect of the goods or services for which it is registered, the trade mark is liable to mislead the public, particularly as to the nature, quality or geographical origin of those goods and services, the rights of the proprietor of the EUTM should be declared to be revoked.

The CJEU specifically stated that **the conditions for revocation** according to [Article 12\(2\) of Directive 89/104/EEC](#), the wording of which is in essence identical to [Article 58\(1\)\(c\) EUTMR](#), **are the same as those for applying the absolute grounds**

**of deceptive marks corresponding to [Article 7\(1\)\(g\) EUTMR](#)** (30/03/2006, [C-259/04](#), Elizabeth Emanuel, EU:C:2006:215, § 53).

However, unlike [Article 7\(1\)\(g\) EUTMR](#), the relevant point of time under [Article 58\(1\)\(c\) EUTMR](#) is the situation **after the registration of the mark** (16/05/2017, [R 1289/2016-2](#), JOHN COR, § 14, § 20). It requires that account be taken of the **actual use** of the mark and thus of **evidence subsequent to its filing** (29/06/2022, Case T-306/20, LA IRLANDESA 1943 (fig.), ECLI:EU:T:2022:404, § 66).

When a list of goods and services is specified in such a way that specific conditions apply, and, after registration, the owner of the mark uses the sign on the market on goods or services in a manner not conforming to those conditions, the mark is liable to be revoked under [Article 58\(1\)\(c\) EUTMR](#) upon cancellation filed by a third party.

This could happen, in particular, when, in order to avoid an objection based on a conflict with i) a GI [[Article 7\(1\)\(j\) EUTMR](#)], (ii) a TTW [[Article 7\(1\)\(k\) EUTMR](#)] or (iii) a TSG [[Article 7\(1\)\(l\) EUTMR](#)] the applicant limits the goods and/or services to conform with the use of (i) a GI, (ii) a TTW or (iii) a TSG respectively, but in the market the goods do not in fact conform with the prescribed use as provided in the relevant EU regulations.

For more on GIs, TTWs and TSGs see the Guidelines, [Part B, Examination, Section 4, Absolute grounds for refusal](#), Chapter 10, Trade marks in conflict with geographical indications ([Article 7\(1\)\(j\) EUTMR](#)), Chapter 11, Trade marks in conflict with traditional terms for wines ([Article 7\(1\)\(k\) EUTMR](#)) and Chapter 12, Trade marks in conflict with traditional specialities guaranteed ([Article 7\(1\)\(l\) EUTMR](#)).

#### 4.2.2 Invalidity (Article 59(1)(a) EUTMR)

A registered EUTM enjoys a presumption of validity, and can be declared invalid only where the EUTM has been registered contrary to the provisions of [Article 7 EUTMR](#), including [Article 7\(1\)\(g\) EUTMR](#). Therefore, [Article 7\(1\)\(g\) EUTMR](#) is applied in the same manner during examination and during an invalidity action brought under [Article 59\(1\)\(a\) EUTMR](#) in relation with [Article 7\(1\)\(g\) EUTMR](#).

A trade mark will be found to be invalid if it can be established that the sign filed for the registration as a mark was per se of such a nature as to deceive the consumer **at the time of filing** of the application for registration, since the **subsequent management of that sign is irrelevant** (8/06/2017, C-689/15, *W.F. Gözze Frottierweberei and Gözze*, EU:C:2017:434, § 55-56). The consideration of **subsequent evidence to the date of filing** of a trade mark application may be taken into account **only if it clarifies the circumstances of the situation as they were on that date** (03/06/2009, T-189/07, *Flugbörse*, EU:T:2009:172, § 19, 28) (all referred to in 29/06/2022, T-306/20, *La irlandesa 1943 (fig.)*, ECLI:EU:T:2022:404, § 66-68).



***GUIDELINES FOR EXAMINATION OF  
EUROPEAN UNION TRADE MARKS***

***EUROPEAN UNION  
INTELLECTUAL PROPERTY OFFICE  
(EUIPO)***

***Part B***

***Examination***

***Section 4***

***Absolute grounds for refusal***

***Chapter 9***

***Trade Marks in conflict with flags and other  
symbols (Article 7(1)(h) and (i) EUTMR)***

## Table of Contents

<b>1 Introduction.....</b>	<b>588</b>
<b>2 Article 7(1)(h) EUTMR.....</b>	<b>588</b>
2.1 Objective of Article 7(1)(h) EUTMR.....	588
2.2 Relevant emblems and signs protected.....	588
2.3 Applicability of Article 7(1)(h) EUTMR.....	592
<b>3 Article 7(1)(i) EUTMR — Emblems not Protected under Article 6ter PC.....</b>	<b>601</b>
3.1 Objective of Article 7(1)(i) EUTMR.....	601
3.2 Protected symbols.....	602
<b>4 Exceptions.....</b>	<b>605</b>

## 1 Introduction

[Article 7\(1\)\(h\) EUTMR](#) incorporates [Article 6ter](#) of the Paris Convention for the Protection of Industrial Property (PC) into the European Union trade mark system. It therefore protects armorial bearings, flags and other state emblems of states that are party to the PC, as well as official signs and hallmarks indicating control and warranty adopted by them. This protection was extended to armorial bearings, flags, other emblems, abbreviations and names of intergovernmental organisations (IGOs) in 1958. [Article 7\(1\)\(h\) EUTMR](#) applies only if the sign applied for is identical to a protected 'emblem' or is a heraldic imitation of such an 'emblem'.

[Article 7\(1\)\(i\) EUTMR](#) protects badges, emblems and escutcheons that are not protected under [Article 6ter PC](#) but are of public interest.

## 2 Article 7(1)(h) EUTMR

### 2.1 Objective of Article 7(1)(h) EUTMR

The objective of [Article 6ter PC](#) is to exclude the registration and use of trade marks that are identical or notably similar to state emblems, official signs and hallmarks indicating control and warranty adopted by the states or the emblems, abbreviations and names of IGOs. Such registration or use would adversely affect the right of the authority concerned to control the use of the symbols of its sovereignty, and might, moreover, mislead the public as to the origin of the goods and services for which these marks are used.

Registration of these emblems and signs, as well as any imitation from a heraldic point of view, either as a trade mark or as an element thereof, must be refused if no authorisation has been granted by the competent authority.

Members of the World Trade Organization (WTO) enjoy the same protection pursuant to [Article 2\(1\) TRIPS](#), according to which members of the WTO must comply with [Articles 1 to 12 and 19 PC](#).

### 2.2 Relevant emblems and signs protected

#### State flags

A state flag is defined by the constitution of a state or by a specific law of that state. Normally, a state will have only one state flag.

For instance, the Spanish flag is defined in Article 4 of the Spanish Constitution; the French flag is defined in Article 2 of the French Constitution; and the German flag is defined in Article 22 of the German Constitution.

State flags enjoy protection per se without any need for registration at WIPO pursuant to [Article 6ter\(3\)\(a\) PC](#). There is no need to establish any link between the goods and services applied for and the country; state flags enjoy absolute protection.

Armorial bearings, flags, and other state emblems

Armorial bearings normally consist of a design or image depicted on a shield. An example of an armorial bearing is the coat of arms of Spain.



Apart from the state flag (protected per se), a member state of the PC may also request protection for other flags, namely those of its first political division in a federal state. For instance, Germany has requested protection for the flags of each *Bundesland* ('federal state').



In contrast, Spain has not requested protection for the flag of the *Comunidades Autónomas* (Autonomous Communities), only for the state flag and the state flag with the coat of arms. France and the United Kingdom are examples of states that have not requested protection for any flag.

The expression 'other state emblems' indicates any emblems constituting the symbol of the sovereignty of a state. This might be a representation of the national crown,

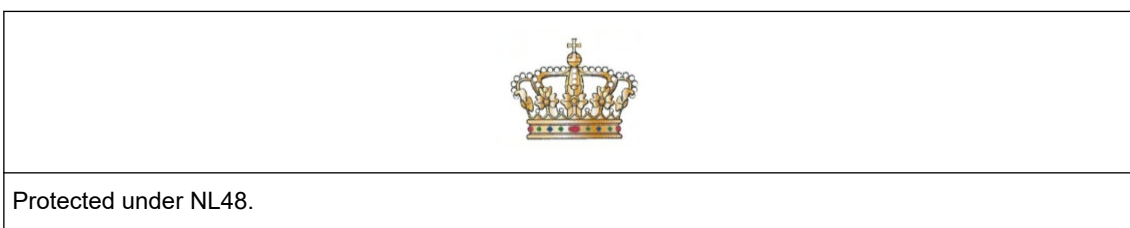

or the official seal of a member state of the PC,



Protected under US1.

Like state flags, armorial bearings, flags, and other state emblems enjoy absolute protection, irrespective of the goods and services applied for.

Official signs and hallmarks indicating control and warranty

The purpose of official signs and hallmarks indicating control and warranty is to certify that a state or an organisation duly appointed by a state for that purpose has checked that certain goods meet specific standards or are of a given level of quality. There are official signs and hallmarks indicating control and warranty in several states for precious metals or products such as butter, cheese, meat, electrical equipment, etc. Official signs and hallmarks may also apply to services — for instance, those relating to education, tourism, etc.

These symbols are normally registered at WIPO for specific products and services, such as:

	
Protected under BR6 for tourism; national and international promotion and advertising; marketing studies; business management; business administration; and office functions.	Protected under JP3 for agricultural, forestry and fishery products and foodstuffs.

Other typical examples are signs of warranty for metals, such as:



		
Protected under CZ35 for platinum	Protected under IT13 for gold	Protected under HU10 for silver

Official signs and hallmarks indicating control and warranty enjoy protection only for goods of the same or a similar kind pursuant to [Article 6ter\(2\) PC](#) (no absolute protection).

Armorial bearings, names, abbreviations and other emblems of intergovernmental organisations

Intergovernmental organisations of which one or more member states of the PC is a member enjoy protection for their armorial bearings, names, abbreviations and other emblems.

For instance, the following signs enjoy protection under the Paris Convention:

		
Protected under QO60.	Protected under QO1.	Protected under QO1248.

AU
Protected under QO884 for the AFRICAN UNION.

The European Union has requested, for instance, protection for the following signs, abbreviations and names:

	EUIPO	European Union Intellectual Property Office
Published under QO1717	Published under QO1742 (QO1743 to QO1746 in other languages)	Published under QO1718 (QO1719 to QO1741 in other languages)

Pursuant to [Article 6ter\(1\)\(c\) PC](#), armorial bearings, names, abbreviations and other emblems of IGOs enjoy protection only for goods and services applied for that would suggest to the public that a connection exists between the organisation concerned and the armorial bearings, flags, emblems, abbreviations, and names, or if the trade mark misleads the public about the existence of a connection between the user and the organisation.

Even though the European Union is not a state in terms of international law, but rather an international intergovernmental organisation, its area of activity is equated with that of a state (12/05/2011, [R 1590/2010-1](#), EUROPEAN DRIVESHAFT SERVICES EDS (fig.), § 54; 15/01/2013, [T-413/11](#), European Driveshaft Services, EU:T:2013:12, § 70).

Consequently, the emblems of the European Union enjoy protection for all goods and services and there is no need to establish any specific link.

Pursuant to the [Article 6ter\(1\)\(b\) PC](#), [Article 6ter PC](#) is not applicable to any armorial bearings, flags, other emblems, abbreviations, and names that are already the subject of international agreements in force intended to ensure their protection (e.g. under the Geneva Convention).

#### Search for emblems

Relevant information about emblems protected under the Paris Convention is found in the WIPO Article 6ter database (<http://www.wipo.int/ipdl/en/6ter/>). The database can be searched by 'state' (i.e. country), by 'category' (i.e. the type of 'emblem') and by 'Vienna Classification'.

A Google image search (<https://images.google.com/>) might give some basic hints for identifying an emblem before the Article 6ter database is checked.

Since state flags enjoy protection per se without any need for registration at WIPO they are normally not found in the WIPO Article 6ter database (unless the flag is, at the same time, protected as another state emblem). Tools for finding flags such as <http://www.flagid.org> or <http://www.flag-finder.com> can be consulted.

## 2.3 Applicability of Article 7(1)(h) EUTMR

To fall foul of [Article 7\(1\)\(h\) EUTMR](#), a trade mark:

- must **consist** solely of an identical reproduction or a 'heraldic imitation' of the abovementioned symbols; or
- must **contain** an identical reproduction or a 'heraldic imitation' of the abovementioned symbols.

Furthermore, the competent authority must not have given its **authorisation** (see [paragraph 4](#) below).

In principle, prohibition of the imitation of an emblem applies only to **imitations of it from a heraldic perspective**, that is to say, those that contain heraldic connotations that distinguish the emblem from other signs. Therefore, protection against any imitation from a heraldic point of view refers not to the image itself, but to its heraldic expression. Therefore, it is necessary to consider the **heraldic description** of the emblem at issue to determine whether the trade mark contains an imitation from a heraldic point of view, (16/07/2009, [C-202/08 P](#) & [C-208/08 P](#), RW feuille d'érable, EU:C:2009:477, § 48; 05/05/2011, [T-41/10](#), esf école du ski français (fig.), EU:T:2011:200, § 25).

It follows from the above that, in the course of trade mark examination, as a first step, both the protected 'emblem' and the sign applied for must be considered from a heraldic perspective.

Nonetheless, the Court ruled that as far as 'imitation from a heraldic point of view' is concerned, a difference detected by a specialist in heraldic art between the trade mark

applied for and the state emblem will not necessarily be perceived by the average consumer and, therefore, in spite of differences at the level of certain heraldic details, the contested trade mark may be an imitation of the emblem in question within the meaning of Article 6ter PC (16/07/2009, [C-202/08 P](#) & [C-208/08 P](#), RW feuille d'érable, EU:C:2009:477, § 50 et seq.; 25/05/2011, [T-397/09](#), Suscipere et finire, EU:T:2011:246, § 24-25).

To apply [Article 7\(1\)\(h\) EUTMR](#), **it can therefore be sufficient that the average consumer, despite some differences in heraldic details, can see in the mark an imitation of the 'emblem'**. There may, for example, be imitation when the mark contains the main element of, or part of, the 'emblem' protected under [Article 6ter PC](#). That element need not necessarily be identical to the emblem in question. The fact that the emblem in question is **stylised** or that only **part of the emblem** is used does not necessarily mean that there is no imitation from a heraldic point of view (21/04/2004, [T-127/02](#), ECA, EU:T:2004:110, § 41).

The EUTM applied for contains a protected 'emblem'

As a first step, it is important that the examiner identifies the various elements of the EUTM applied for and establishes the part that is considered to be the reproduction or heraldic imitation of an 'emblem' protected under [Article 6ter PC](#). The **size** of the protected emblem contained in the EUTM is irrelevant, as long as it is **legible** and **perceivable**.

The fact that the EUTM applied for **also contains word elements** does not in itself preclude application of [Article 6ter PC](#) (21/04/2004, [T-127/02](#), ECA, EU:T:2004:110, § 41). On the contrary, such a word element may even strengthen the link between the EUTM application and an emblem (13/03/2014, [T-430/12](#), European Network Rapid Manufacturing, EU:T:2014:120, § 66 et seq.; 28/10/2014, [R 1577/2014-4](#), SWISS CONCEPT, § 33).





Examples:

- Heraldic imitation found

Flag	Sign applied for
The flags of Norway, France, Austria, Germany, Sweden, France, Czech Republic, Belgium, Denmark, Ireland, Italy and Finland (from the top in a clockwise circle).	
	EUTM application No 10 502 714; 17/06/2013, <a href="#">R 1291/2012-2</a> , WHO WANTS TO BE A FOOTBALL MILLIONAIRE (fig.)
The colours are recognisable and follow the structure of the flags.	

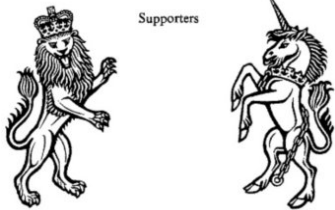







	
<p>Flag of the United Kingdom</p>	<p>EUTM application No 13 169 313</p>
<p>The trade mark contains a faithful representation of the UK flag in terms of colour/configuration. The slight degree of stylisation does not take it outside the scope of heraldic imitation.</p>	
	
<p>French flag</p>	<p>18/03/2015, <a href="#">R 1731/2013-1</a>, LAPIN NA LA NOUVELLE AGRICULTURE (fig.)</p>
<p>The French flag is incorporated into the trade mark. Although it is small, it is immediately recognisable.</p>	
	
<p>Emblem (Bavaria) protected under DE26</p>	<p>EUTM No 12 031 531; 26/02/2015, <a href="#">R 1166/2014-1</a>, ALPENBAUER BAYRISCHE BONBONLUTSCHKULTUR (fig.)</p>
<p>The escutcheon with the white and blue diamonds contained in the sign applied for reproduces the heraldic symbol of the lesser Bavarian state coat of arms.</p>	

 	
<p>Protected under GB3 Protected under GB4</p>	<p>EUTM No 5 627 245; 23/07/2009, <a href="#">R 1361/2008-1</a>, SUSCIPERE ET FINIRE (fig.)</p>
<p>The Board of Appeal took into account the heraldic description of the protected emblems in order to consider whether there was a heraldic imitation (paras 24 and 27).</p> <p>As regards the emblem protected under GB3, it concluded that since central elements such as the quartered shield and the supporters were largely identical, this was in this respect an imitation in the heraldic sense. The differences were not sufficient to give the EUTM application new meaning from a heraldic point of view. As regards the emblem protected under GB4, it concluded that the only difference between the supporters was the representation of the crowns, which would go unnoticed by the general public.</p>	
	
<p>Swiss flag</p>	<p>EUTM No 9 273 137</p>
<p>In spite of a slight stylisation, the Swiss flag is immediately recognisable in the sign with the same structure and colours as the protected flag.</p>	

- Heraldic imitation not found









<p><b>Flag</b></p>	<p><b>Sign applied for</b></p>
--------------------	--------------------------------

	
<p>French flag</p>	<p>EUTM No 4 624 987, 05/05/2011, <a href="#">T-41/10</a>, esf école du ski français (fig.)</p>
<p>Although the colours are recognisable, the sign does not have the structure of the French flag.</p>	
	
<p>Peruvian flag</p>	<p>EUTM No 14 913 438</p>
<p>The mark is acceptable under <a href="#">Article 7(1)(h) EUTMR</a>. The dimensions of the stripes and also the overall shape of the figurative element are different from that of the Peruvian flag.</p>	
	
<p>Flag of the United Kingdom</p>	<p>EUTM No 15 008 253</p>
<p>The trade mark is not a faithful representation of the UK flag in terms of colour/configuration. The high degree of stylisation takes it outside the scope of heraldic imitation.</p>	

The fact that the EUTM applied for **contains only part of the protected ‘emblem’** does not mean that there may not be an imitation from a heraldic point of view (21/04/2004, [T-127/02](#), ECA, EU:T:2004:110, § 41). As regards the flag of the European Union, its essential element is the circle of twelve golden mullets (stars) (14/07/2011, [R 1903/2010-1](#), A (fig.), § 17). However, to qualify as a heraldic imitation, it is not necessary for all the stars to be present in the EUTM applied for (13/03/2014, [T-430/12](#), European Network Rapid Manufacturing, EU:T:2014:120). The exact orientation of the stars is irrelevant (15/01/2013, [T-413/11](#), European Driveshaft Services, EU:T:2013:12). The same is true with respect to their colour (15/01/2013, [T-413/11](#), European Driveshaft Services, EU:T:2013:12, § 43 for silver; 13/03/2014, [T-430/12](#), European Network Rapid Manufacturing, EU:T:2014:120, § 48 for red; 14/07/2011, [R 1903/2010-1 A](#) (fig.), § 17 for blue).







Earlier case-law of the Boards of Appeal, such as decisions of 11/10/2011, [R 1991/2010-4](#), EASI EUROPEAN ALLIANCE SOLUTIONS INNOVATIONS and [R 5/2011-4](#), TEN, which did not follow the approach taken above, was overruled by the General Court (13/03/2014, [T-430/12](#), European Network Rapid Manufacturing, EU:T:2014:120).



- Main characteristics/part of the emblem **incorporated** in the trade mark

Protected 'emblem'	Sign applied for
	
Protected under QO188	EUTM application No 6 697 916; 01/03/2012, <a href="#">R 1211/2011-1</a> , DIRO.net Lawyers for Europe (fig.); 13/03/2014, <a href="#">T-430/12</a> , European Network Rapid Manufacturing
The EUTM applied for consists of a circle of 12 stars, of which three are covered. It contains the most important element of the European flag. The adjective 'European' reinforces the link already established by the circle of stars.	
	
Protected under QO188	EUTM No 6 373 849; 14/07/2011, <a href="#">R 1903/2010-1</a> , A (fig.)
Since the EUTM contains an element that amounts to a heraldic imitation of the European emblem and the EUTM owner could not justify any authorisation, the registration must be declared invalid (para. 27).	
	
Protected under QO188	EUTM No 4 819 686; 21/03/2012, <a href="#">R 2285/2010-2</a> , EUROPEAN MOO DUK KWAN TANG SOO DO FEDERATION
One element of the contested EUTM contains an imitation of all the heraldic elements of the European emblem (para. 48).	
	

Emblem (Bavaria) protected under DE24	EUTM No 12 031 531; 26/02/2015, <a href="#">R 1166/2014-1</a> , ALPENBAUER BAYRISCHE BONBONLUTSCHKULTUR (fig.)
The escutcheon with the white and blue diamonds contained in the sign applied for reproduces the heart shield in the greater Bavarian state coat of arms.	

- Main characteristics/part of the protected emblem **not incorporated** in the trade mark









Protected 'emblem'	Sign applied for
	
Protected under IE11	EUTM application No 11 945 797; 01/04/2014, <a href="#">R 139/2014-5</a> , REPRESENTATION OF A CLOVERLEAF (fig.)
It must also be taken into consideration that the graphic element of the sign applied for has a colour configuration that is clearly different from the Irish national symbols. These elements are so strong that the mere fact that the sign applied for also contains a cloverleaf does not mean that the sign is similar to one of the national emblems of Ireland (paras 18-19).	
	
Protected under SE20	EUTM application No 13 580 981
The mark is not a heraldic imitation of the Swedish armorial bearing; it contains only one of the three crowns that are the main characteristic of the Swedish armorial bearing.	
	



Protected under CA2	EUTM application No 15 951 262
The mark is not a heraldic imitation of the Canadian state emblem.	
	
Protected under QO188	EUTM application No 15 889 157
The mark is not a heraldic imitation of the European emblem.	

#### Black and white representations of the protected emblem



Flags are often reproduced in black and white; therefore, a black and white depiction of a protected emblem (or vice versa) may still be considered a heraldic imitation (21/04/2004, [T-127/02](#), ECA, EU:T:2004:110, § 45; 28/02/2008, [T-215/06](#), RW feuille d'érable, EU:T:2008:55, § 68).

Examples:

Flag	Sign applied for
	
Protected under QO188	21/04/2004, <a href="#">T-127/02</a> , ECA
	
Protected under CA1	EUTM application No 2 793 495
	
Protected under CA2	<a href="#">C-202/08 P</a> & <a href="#">C-208/08 P</a>
	
Flag of the United Kingdom	Invented example

	
Protected under CH27	28/10/2014, <a href="#">R 1577/2014-4</a>

However, if the black and white depiction does not allow recognition of a specific flag, there is no heraldic imitation.

Flag	Sign applied for
	
Various state flags	Invented example
It is not possible to recognise a specific flag, as the sign could be a black and white reproduction of any of the four flags reproduced above.	

### Changes in colour

The use of silver v gold is important in heraldry. However, average consumers will not necessarily recognise this difference in colour; indeed, they will not even give it any importance (15/01/2013, [T-413/11](#), European Driveshaft Services, EU:T:2013:12, § 43). Slight differences in the actual colour are irrelevant (light blue v dark blue). Heraldry does not normally distinguish between different tones of the same colour (15/01/2013, [T-413/11](#), European Driveshaft Services, EU:T:2013:12, § 42). Furthermore, gold is often reproduced as yellow (20/05/2009, [R 1041/2008-1](#), kultur IN DEUTSCHLAND + EUROPA (fig.), § 33); consequently, this difference has no impact on the assessment.

Protected Emblem	Sign applied for
	

Protected under QO188	EUTM No 2 180 800; 15/01/2013, <a href="#">T-413/11</a> , European Driveshaft Services
The Court maintained that even as regards professionals the possibility of making a connection between the sign represented above and the organisation concerned is not excluded (para. 66).	

### 3 Article 7(1)(i) EUTMR — Emblems not Protected under Article 6ter PC

#### 3.1 Objective of Article 7(1)(i) EUTMR

[Article 7\(1\)\(i\) EUTMR](#) applies to all other badges, emblems or escutcheons that

1. have not been communicated in accordance with [Article 6ter\(3\)\(a\) PC](#), regardless of whether they are the emblems of a state or international intergovernmental organisation within the meaning of [Article 6ter\(1\)\(a\) or \(b\) PC](#), or of public bodies or administrations other than those covered by [Article 6ter PC](#), such as provinces or municipalities  
and
2. are of particular public interest,

unless the competent authority has consented to their registration.

[Article 7\(1\)\(i\) EUTMR](#) does not define symbols of ‘particular public interest’. The nature of these symbols could vary and could include, for example, symbols of public bodies or administrations, such as provinces or municipalities. In any case, the ‘particular public interest’ involved must be reflected in a public document, for example a national or international legal instrument, regulation or other normative act.

The General Court stated that a ‘**particular public interest**’ existed when the emblem had a particular link with one of the activities carried out by an international intergovernmental organisation (10/07/2013, [T-3/12](#), Member of €e euro experts, EU:T:2013:364, § 44). In particular, the Court specified that [Article 7\(1\)\(i\) EUTMR](#) also applied when the emblem merely related to one of the areas of activity of the European Union, even if that activity concerned only certain EU Member States (10/07/2013, [T-3/12](#), Member of €e euro experts, EU:T:2013:364, § 45-46). This confirms that the protection afforded by [Article 7\(1\)\(i\) EUTMR](#) also applies to symbols that are of particular public interest in only a single Member State or part thereof ([Article 7\(2\) EUTMR](#)).

According to the case-law, [Article 7\(1\)\(i\) and \(h\) EUTMR](#) both have a similar scope of application and grant equivalent levels of protection. Therefore, [Article 7\(1\)\(i\) EUTMR](#) covers identical reproduction (full or partial) in a trade mark of the abovementioned symbols, as well as their heraldic imitation.



Following the same line of reasoning, [Article 7\(1\)\(i\) EUTMR](#) applies where the mark is liable to **mislead the public** as to the existence of a connection between the owner of the trade mark and the body to which the abovementioned symbols refer. In other words, **the protection afforded by [Article 7\(1\)\(i\) EUTMR](#) is conditional on a link between the mark and the symbol (no absolute protection)**. Otherwise, trade marks to which [Article 7\(1\)\(i\) EUTMR](#) applies would obtain broader protection than under [Article 7\(1\)\(h\) EUTMR](#) (10/07/2013, [T-3/12](#), Member of €e euro experts, EU:T:2013:364).

### 3.2 Protected symbols

The following signs (not covered by [Article 6ter PC](#)) enjoy special protection under [Article 7\(1\)\(i\) EUTMR](#):

- the euro sign (€, as defined by the European Commission, [http://ec.europa.eu/economy\\_finance/euro/cash/symbol/index\\_en.htm](http://ec.europa.eu/economy_finance/euro/cash/symbol/index_en.htm));

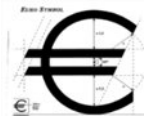



- the symbols protected under the Geneva Conventions and their additional protocols, that is to say, the red cross, the red crescent and the red crystal emblems and their names (<https://www.icrc.org/en/war-and-law/emblem>);



However, a number of well-known red crosses have traditionally been used and are still in use, the incorporation of which in a mark would not be considered a reproduction/heraldic imitation of the 'Red Cross'.

Examples of these crosses include the following:

'Templar cross'	
'Maltese cross'	







- the Olympic Symbol protected under the Nairobi Treaty on the Protection of the Olympic Symbol ([http://www.wipo.int/treaties/en/text.jsp?file\\_id=287432](http://www.wipo.int/treaties/en/text.jsp?file_id=287432))

<p>The five interlaced rings in blue, yellow, black, green and red, arranged in that order from left to right. The symbol consists of the Olympic rings alone, whether in a single colour or in different colours, as set out in the Nairobi Treaty on the Protection of the Olympic Symbol.</p>	
--	--

The same rules as set out above concerning the heraldic imitation and authorisations also apply with respect to [Article 7\(1\)\(i\) EUTMR](#).

#### Examples

- Reproduction/heraldic imitation found

Symbol	Sign applied for
	
	<p>EUTM application No 6 110 423, 10/07/2013, <a href="#">T-3/12</a>.</p>
<p>The EUTM contains an imitation of the euro symbol in a central position. A link will be established with the European Union. The other elements reinforce the link between the EUTM and the euro sign (para. 109 et seq).</p>	
	
	<p>EUTM application No 2 966 265, applied for in respect of goods and services in Classes 9, 38, 42 and 44.</p>
<p>Trade mark cancelled by decision of 13/05/2008, 2 192 C. The EUTM clearly contains the emblem of the Red Cross on a white background, as defined by and protected by the Geneva Convention, as a discernible, individual portion of the mark (para. 23).</p>	
	
	<p>EUTM application No 5 988 985, applied for in respect of goods and services in Classes 28 and 30.</p>
<p>The trade mark contains the representation of the Red Cross, protected by the Geneva Convention.</p>	

- Reproduction/heraldic imitation not found

Symbol	Sign applied for
	
	<p>28/06/2007, <a href="#">R 315/2006-1</a>, D&amp;W REPAIR (fig.), applied for in respect of goods and services in Classes 8, 11 and 12.</p>
<p>In the present case, the Red Cross cannot be said to be included in the contested EUTM because of the difference in colour. The Red Cross, as its denomination indicates, is red and the colour constitutes a very essential element of its protection. The cancellation applicant's argument that the colour orange may be very similar to some shades of red cannot be accepted (para. 20).</p> <p>Additionally, the cross of the contested EUTM contains the wording 'REPAIR' which, coupled with the goods concerned (tools, car spare parts and accessories in Classes 8, 11 and 12), is likely to be associated with car and motorcycle repairs. This association makes the orange cross of the contested EUTM even more distinct from the Red Cross emblem protected by the Geneva Convention (para. 21).</p>	
	
	<p>EUTM application No 10 868 985, applied for in respect of goods and services in Classes 12, 35, 38, 39 and 42 (car rental related).</p>
<p>No link will be made with the European Union; the symbol rather refers to the 'good price' of the goods and services concerned.</p>	
	
	<p>EUTM application No 11 076 866, applied for in respect of goods and services in Classes 9, 35, 36, 37 and 42 (e.g. <i>electricity measuring devices, services related to building and construction</i>).</p>
<p>No link will be made with the European Union; the symbol will be perceived as a stylised letter 'E'.</p>	

## 4 Exceptions

The EUTM applied for can be registered despite [Article 7\(1\)\(h\) and \(i\) EUTMR](#) if the applicant provides the Office with the authorisation to include the protected emblem or parts of it in its trade mark. The authorisation must cover registration as a trade mark or as a part thereof. Authorisation to use the protected emblem is not sufficient.



It is up to the applicant to submit the authorisation. The Office cannot enquire as to whether an authorisation exists, either on an individual or general level.

Even in cases where **general** announcements or authorisations are rendered by competent authorities under national law to use a protected emblem in trade, and these are submitted by the applicant, it should be carefully examined on a case-by-case basis whether such authorisations **specifically** authorise the use of an emblem in a trade mark (26/02/2015, [R 1166/2014-1](#), ALPENBAUER BAYERISCHE BONBONLUTSCHKULTUR (fig.), § 23-29).

It is also important to mention that the provisions of [Article 7\(1\)\(h\) and \(i\) EUTMR](#) are not applicable to trade marks that were registered either before receipt of the notification from WIPO or less than 2 months after receipt of said notification.

State flags that are not submitted to WIPO enjoy protection only against trade marks that were registered after 06/11/1925.

If an EUTM applied for contains or consists of the heraldic imitation of emblems of two or more states, which are similar, it is sufficient to present authorisation from one of them ([Article 6ter\(8\) PC](#)).

	
State flag of the Netherlands	State flag of Luxembourg

***GUIDELINES FOR EXAMINATION OF  
EUROPEAN UNION TRADE MARKS***

***EUROPEAN UNION  
INTELLECTUAL PROPERTY OFFICE  
(EUIPO)***

***Part B***

***Examination***

***Section 4***

***Absolute grounds for refusal***

***Chapter 10 Trade Marks in Conflict with  
Geographical indications (Article 7(1)(j)  
EUTMR)***

## Table of Contents

<b>1 Article 7(1)(j) EUTMR.....</b>	<b>609</b>
<b>2 Definition of geographical indications under EU regulations.....</b>	<b>610</b>
<b>3 Relevant GIs under EU Regulations.....</b>	<b>612</b>
3.1 Relevant point in time.....	612
<b>4 Situations covered by the EU regulations and absolute grounds examination.....</b>	<b>613</b>
4.1 Use of a GI (direct or indirect use).....	614
4.1.1 Exploitation of the reputation of GIs.....	617
4.2 Misuse, imitation or evocation of a GI.....	618
4.2.1 Misuse.....	618
4.2.2 Imitation/evocation.....	618
4.3 Other misleading indications and practices.....	625
4.4 Additional considerations.....	626
4.4.1 Translations.....	626
4.4.2 Use of delocalisers.....	627
4.4.3 Location of the applicant's legal seat.....	628
4.4.4 GIs not known to the public.....	628
4.5 Limits to the scope of protection.....	629
4.5.1 Elements that will not be afforded protection.....	629
4.5.2 Terms commonly used in trade.....	630
4.5.3 Logical and conceptual unit.....	632
4.5.4 Names of countries, regions.....	635
4.6 Trade marks in conflict with two or more GIs.....	638
<b>5 Relevant Goods under EU Regulations.....</b>	<b>642</b>
5.1 Identical products.....	642
5.2 Comparable products.....	643
5.3 Restriction of the list of goods.....	646
<b>6 GIs not Protected under EU Regulations.....</b>	<b>652</b>
6.1 GIs protected at national level in an EU Member State.....	652
6.2 GIs from non-EU countries.....	653
6.2.1 GI is protected only in the non-EU country of origin under its national legislation....	653
6.2.2 GI is protected under an agreement to which the EU is a contracting party.....	654
6.2.3 GI is protected under the Lisbon System (Geneva Act).....	655
6.2.4 GI is protected under an international agreement signed only by Member States (i.e. the EU is not a party).....	658

6.3 Relationship with other EUTMR provisions.....659

## 1 Article 7(j) EUTMR

[Article 7\(1\)\(j\) EUTMR](#) provides for the refusal of EUTMs that are excluded from registration pursuant to national or EU legislation or to international agreements to which the EU or the Member State concerned is party and that protect designations of origin and geographical indications. When defining the protection given to these specific designations, the relevant regulations refer simply to the protected/registered names, regardless of whether those names refer to a protected designation of origin (PDO) or a protected geographical indication (PGI). Moreover, the scope of protection does not rely on any distinction between PDOs and PGIs, as all the protected names are given the same scope of protection. Therefore, this Chapter will refer to these protected names as geographical indications (GIs) without making any distinction between them.

As regards **EU legislation** protecting GIs, the following EU regulations are currently in place:

- [Regulation \(EU\) No 1308/2013](#) <sup>(23)</sup> in respect of *wines*;
- [Regulation \(EU\) 2019/787](#) <sup>(24)</sup> in respect of *spirit drinks*;
- [Regulation \(EU\) No 1151/2012](#) <sup>(25)</sup> in respect of *agricultural products and foodstuffs*.

As a consequence, [Article 7\(1\)\(j\) EUTMR](#) applies where GIs have been registered under the procedure laid down by these EU regulations. Importantly, GIs registered at EU level can originate from both EU Member States and non-EU countries.

Article 7(1)(j) EUTMR also applies to EUTMs that are in conflict with non-EU GIs that enjoy protection in the EU through **international agreements to which the EU is a party** (see [paragraph 6.2](#) below).

The Office interprets the ‘national legislation’ referred to in Article 7(1)(j) EUTMR as relating exclusively to national legislation providing for the protection of GIs in those areas where there is not a uniform and exclusive system of EU protection, namely those areas not covered by the abovementioned EU regulations. For the purposes of these Guidelines, they will be referred to as craft and industrial GIs (e.g. *handicrafts*).

As regards **international agreements concluded by Member States only**, and by analogy with the Office’s interpretation of Article 7(1)(j) EUTMR as far as national law is concerned, the Office considers that reference to an ‘international agreement to which

---

<sup>23</sup> [Regulation \(EU\) No 1308/2013](#) of the European Parliament and of the Council of 17 December 2013 establishing a common organisation of the markets in agricultural products and repealing Council Regulations (EEC) No 922/72, (EEC) No 234/79, (EC) No 1037/2001 and (EC) No 1234/2007.

<sup>24</sup> Regulation (EU) 2019/787 of the European Parliament and of the Council of 17 April 2019 on the definition, description, presentation and labelling of spirit drinks, the use of the names of spirit drinks in the presentation and labelling of other foodstuffs, the protection of geographical indications for spirit drinks, the use of ethyl alcohol and distillates of agricultural origin in alcoholic beverages, and repealing [Regulation \(EC\) No 110/2008](#).

<sup>25</sup> Regulation (EU) No 1151/2012 of the European Parliament and of the Council of 21 November 2012 on quality schemes for agricultural products and foodstuffs, as amended by Regulation (EU) 2021/2117 of the European Parliament and of the Council of 2 December 2021 amending Regulations (EU) No 1308/2013 establishing a common organisation of the markets in agricultural products, (EU) No 1151/2012 on quality schemes for agricultural products and foodstuffs, (EU) No 251/2014 on the definition, description, presentation, labelling and the protection of geographical indications of aromatised wine products, and (EU) No 228/2013 laying down specific measures for agriculture in the outermost regions of the Union.



the Member State concerned is party' should be interpreted as referring to international agreements (including the Lisbon Agreement) in areas for which there is no uniform EU protection in place, namely craft and industrial products (see [paragraph 6.2](#) below).

## 2 Definition of geographical indications under EU regulations

As regards **wines**, according to [Article 93 of Regulation \(EU\) No 1308/2013](#):

'designation of origin' means a name, including a traditionally used name, which identifies a product:

1. whose quality or characteristics are essentially or exclusively due to a particular geographical environment with its inherent natural and human factors;
2. as originating in a specific place, region or, in exceptional cases, country;
3. produced from grapes which originate exclusively from that geographical area;
4. the production of which takes place in that geographical area; and
5. which is obtained from vine varieties belonging to *Vitis vinifera* or a cross between the *Vitis vinifera* species and other species of the genus *Vitis*.

'geographical indication' means a name, including a traditionally used name, which identifies a product:

1. whose specific quality, reputation or other characteristics are attributable to its geographical origin;
2. as originating in a specific place, region or, in exceptional cases, country;
3. as having at least 85 % of the grapes used for its production come exclusively from that geographical area;
4. the production of which takes place in that geographical area; and
5. which is obtained from vine varieties belonging to *Vitis vinifera* or a cross between the *Vitis vinifera* species and other species of the genus *Vitis*.

As regards **spirit drinks**, according to [Article 3\(4\) of Regulation \(EU\) 2019/787](#), a 'geographical indication' is an indication that identifies a spirit drink as originating in the territory of a country, or a region or locality in that territory, where a given quality, reputation or other characteristic of that spirit drink is essentially attributable to its geographical origin.

Finally, as regards **agricultural products and foodstuffs**, pursuant to [Article 5 of Regulation \(EU\) No 1151/2012](#), a 'designation of origin' is a name, which may be a traditionally used name, which identifies a product:

1. originating in a specific place, region or, in exceptional cases, country;
2. whose quality or characteristics are essentially or exclusively due to a particular geographical environment with its inherent natural and human factors; and
3. the production steps of which all take place in the defined geographical area.

A 'geographical indication' is a name, including a traditionally used name, which identifies a product:

1. originating in a specific place, region or country;
2. whose given quality, reputation or other characteristic is essentially attributable to its geographical origin; and
3. at least one of the production steps of which takes place in the defined geographical area.

The difference, where there is one, between PDOs and PGIs is that the former have a **closer link** with the area. In the foodstuffs sector, PDO is the term used to describe foodstuffs that are produced, processed and prepared in a given geographical area using recognised know-how. A PGI indicates a link with the area in at least one of the stages of production, processing or preparation. PDOs therefore have a stronger link with the area.

As already mentioned, this distinction does not affect the scope of protection, which is the same for PDOs and PGIs. In other words, [Article 7\(1\)\(j\) EUTMR](#) applies equally to all designations covered by [Regulation \(EU\) No 1308/2013](#) on *wines* and [Regulation \(EU\) No 1151/2012](#) on *agricultural products and foodstuffs*, regardless of whether they are registered as PDOs or as PGIs. [Regulation \(EU\) 2019/787](#) on *spirits*, however, covers only geographical indications (equivalent to PGIs), and not PDOs.

In this respect, it must also be underlined that the concept of the GI differs from a ‘**mere geographical term**’. For the latter, there is no direct link between a specific quality, reputation or other characteristic of the product and its specific geographical origin, with the result that it does not come within the scope of [Article 93 of Regulation \(EU\) No 1308/2013](#), [Article 3\(4\) of Regulation \(EU\) 2019/787](#) or [Article 5\(2\) of Regulation \(EU\) No 1151/2012](#) (07/11/2000, [C-312/98](#), Haus Cramer, EU:C:2000:599, § 43-44; 08/05/2014, [C-35/13](#), Assica and Krafts Foods Italia, EU:C:2014:306, § 30).

For example, ‘[Rioja](#)’ is a PDO for *wines* since it designates a *wine* with particular characteristics that comply with the definition of a PDO. However, *wine* produced in ‘Tabarca’ (a geographical term designating a small island close to Alicante) cannot qualify for a GI unless it meets specific requirements. Similarly, ‘[Queso Manchego](#)’ is a PDO for *cheese* since it designates a product with particular characteristics that comply with the definition of a PDO. However, ‘Queso de Alicante’ (which uses a type of product in combination with a geographical term) cannot qualify for a GI since it does not enjoy such characteristics and requirements. Geographical terms (such as MONACO or PARIS) can, nonetheless, trigger objections based on [Article 7\(1\)\(c\) EUTMR](#) — see the Guidelines, [Part B, Section 4, Absolute Grounds for Refusal, Chapter 4, Descriptive Trade Marks \(Article 7\(1\)\(c\) EUTMR\)](#).

Protection is granted to GIs in order, inter alia, to protect the **legitimate interests of consumers and producers**. In particular, the specific objectives of protecting designations of origin and geographical indications are to secure a fair return for farmers and producers for the qualities and characteristics of a given product, or of its mode of production, and to provide clear information on products with specific characteristics linked to geographical origin, thereby enabling consumers to make more informed purchasing choices (see recital 18 of [Regulation \(EU\) No 1151/2012](#)). Moreover, their protection aims to ensure that they are used fairly and to prevent

practices liable to mislead consumers (see recital 29 of [Regulation \(EU\) No 1151/2012](#) and recital 97 of [Regulation \(EU\) No 1308/2013](#)).

### 3 Relevant GIs under EU Regulations

[Article 7\(1\)\(j\) EUTMR](#) in combination with the EU regulations applies where GIs (either from an EU Member State or from a non-EU country) have been **registered** under the procedure laid down by Regulations [No 1308/2013](#), [2019/787](#) and [No 1151/2012](#).

Relevant information about registered GIs for *wines*, *spirit drinks* and *agricultural products and foodstuffs* can be found in the [Glview](#) database maintained by the Office. [Glview](#) includes all the official data from the [eAmbrosia](#) register, maintained by the Commission, and information on all GIs protected in the EU under the international agreements as well.

Protection is granted solely to the name of a GI as registered (for example, [Article 13\(1\) of Regulation \(EU\) No 1151/2012](#)) **and does not extend *ipso iure* to the names of subregions, subdenominations, local administrative areas or localities** in the area covered by that GI. The Office, therefore, does not object under [Article 7\(1\)\(j\) EUTMR](#) to trade marks consisting, containing, imitating or evoking such geographical names. In this respect, and in particular as regards *wines*, a distinction must be made between the doctrine of the General Court in its judgment of 11/05/2010, [T-237/08](#), Cuvée Palomar, EU:T:2010:185, and the current legal framework. That judgment refers to a system of Member State competencies on the designation of geographical indications for *wines* that existed under previous [Regulation \(EC\) No 1493/1999](#) but is no longer in force. Under [Article 120\(1\)\(g\) of Regulation \(EU\) No 1308/2013](#), the names of those smaller or larger geographical areas are now considered merely optional particulars on labels.

#### 3.1 Relevant point in time

[Article 7\(1\)\(j\) EUTMR](#) applies only to GIs that were **applied for** before the EUTM application **and are registered** at the time the EUTM application is examined. The relevant dates for establishing the priority of a trade mark and a GI are the date of application of the EUTM application (or what is known as the Paris Convention priority, if claimed) and the date of application for protection of a GI to the Commission respectively.

Notwithstanding the above, and in view of the fact that the vast majority of applications for a GI usually mature into a registration, **an objection will be raised** when the GI was applied for **before** the filing date (or the priority date, if applicable) of the EUTM application **but** had not yet been registered at the time of examining the EUTM application. If the EUTM applicant does not submit observations or does not overcome the objection, the Office will suspend the examination proceedings until the GI registration proceedings are concluded.

Therefore, **no objection will be raised** under [Article 7\(1\)\(j\) EUTMR](#) when the GI was applied for **after** the filing date (or priority date, if applicable) of the EUTM application. The relevant dates for establishing priority of the GI can be found in the [Giview](#) and/or [eAmbrosia](#) respectively.

## 4 Situations covered by the EU regulations and absolute grounds examination

In their **relevant provisions on the scope of protection** the EU regulations refer, *mutatis mutandis*, to a graduated list of prohibited acts against which GIs are protected, namely:

1. any use of a GI (direct or indirect):
  - a. in respect of comparable products that do not comply with the product specification of a GI; or
  - b. insofar as such use exploits, weakens or dilutes<sup>26</sup> the reputation of a GI;
2. any misuse, imitation or evocation;
3. any other false or misleading indications or practices.

However, when applying [Article 7\(1\)\(j\) EUTMR](#), and for the purposes of the absolute grounds examination, the situations listed above are further restricted in accordance with the **relevant provisions governing conflicts with trade marks** as shown in the following paragraphs.

As regards *wines*, according to [Article 102\(1\) of Regulation \(EU\) No 1308/2013](#), the registration of a trade mark the use of which would contravene [Article 103\(2\)](#) of that Regulation, and which relates to **a grapevine product falling under one of the categories listed in Part II of Annex VII**, will be refused if the application for registration of the trade mark was submitted after the date of submission of the application for protection of the designation of origin or geographical indication to the Commission.

As regards *agricultural products and foodstuffs*, according to [Article 14\(1\) of Regulation \(EU\) No 1151/2012](#),

[w]here a designation of origin or a geographical indication is registered under this Regulation, the registration of a trade mark the use of which would contravene [Article 13\(1\)](#) and which relates to **a product of the same type** shall be refused if the application for registration of the trade mark is submitted after the date of submission of the registration application in respect of the designation of origin or the geographical indication to the Commission.

Finally, as regards *spirit drinks*, according to [Article 36\(1\) of Regulation \(EU\) 2019/787](#), 'the registration of a trade mark the use of which corresponds or would correspond to one or more of the situations referred to in [Article 21\(2\)](#) shall be refused or invalidated'.

---

<sup>26</sup> [Regulation \(EU\) 2019/787](#) only refers to use which exploits the reputation of the protected name.

This provision does not contain any specific reference to which products it relates, but the Office interprets this Regulation following the same systematic approach.

In light of the foregoing, the Office considers that, **in the context of examining absolute grounds for refusal**, the protection of GIs under all EU regulations cannot extend to all possible products. The protection is limited to:

- goods identical to the product covered by the GI, including when such goods constitute the **specific object** of services such as *retail, wholesale, import/export, provision of drink and food, production of [the product covered by the GI] for others*;
- goods comparable to the product covered by the GI;
- goods in which the GI is a relevant ingredient.

For further information on the relevant point in time see [paragraph 3.1](#).

In light of the above provisions, **three cumulative conditions** must be met for [Article 7\(1\)\(j\) EUTMR](#) in combination with the EU regulations to apply.

1. The GI in question (either from an EU Member State or from a non-EU country) must be registered at EU level (see [paragraph 3](#)).
2. Use of the EUTM must constitute one of the situations provided for in [Article 103\(2\) of Regulation \(EU\) No 1308/2013](#), [Article 21\(2\) of Regulation \(EU\) 2019/787](#) or [Article 13\(1\) of Regulation \(EU\) No 1151/2012](#) (see [paragraphs 4.1](#) to [4.3](#)).
3. The EUTM application must include relevant goods, as provided above. (For goods to which an objection may be raised see [paragraph 5](#).)

#### 4.1 Use of a GI (direct or indirect use)

As a preliminary remark, ‘direct and indirect use’ need to be defined/interpreted. According to the Court (07/06/2018, [C-44/17](#), SCOTCH WHISKY, EU:C:2018:415, § 32), direct and indirect use merely refer to the physical manner in which the use of a GI appears on the market: ‘direct use’ implies that the GI is affixed directly to the product or its packaging, while ‘indirect use’ requires the GI to feature in supplementary marketing or information sources, such as an advertisement for the product or documents relating to it. This distinction plays no role for the absolute grounds assessment, as the Office is not concerned with the subsequent placing on the market of the mark proposed for registration.



For the purpose of finding whether or not there is use of a GI, the Office will assess whether an EUTM **contains** a GI as a whole or a term that could be considered **phonetically and/or visually highly similar thereto**. According to the Court:

the word ‘use’ ... requires, by definition, that the sign at issue make use of the protected geographical indication itself, in the form in which that indication was registered or, at least, in a form with such close links to it, in visual and/or phonetic terms, that the sign at issue clearly cannot be dissociated from it

(07/06/2018, [C-44/17](#), SCOTCH WHISKY, EU:C:2018:415, § 29; 09/09/2021, [C-783/19](#), Champanillo, EU:C:2021:713, § 38).

The Court has further emphasised that the concept of use must be interpreted in a strict manner so the concept of ‘evocation’ is not deprived of its usefulness, which would be contrary to the intention of the EU legislator (09/09/2021, [C-783/19](#), Champanillo, EU:C:2021:713, § 40).

The following EUTMs are considered to fall under [Article 7\(1\)\(j\) EUTMR](#) since they make use of a GI.

GI	EUTM No
<p><a href="#">CHAMPAGNE</a> (PDO-FR-A1359)</p>	<p><b>CHAMPAGNE VEUVE DEVANLAY</b> (EUTM No 11 593 381)</p>
<p><a href="#">BEAUJOLAIS</a> (PDO-FR-A0934)</p>	 <p>(EUTM No 1 561 646)</p>
<p><a href="#">LISBOA</a> (PGI-PT-A1535)</p>	 <p>(EUTM No 17 945 350)</p>



GI	EUTM No
<p><a href="#">POMEROL</a> (PDO-FR-A0273)</p>	 <p>(EUTM No 17 889 185)</p>
<p><a href="#">RIAS BAIXAS</a> (PDO-ES-A1119)</p>	 <p>(EUTM No 17 067 141)</p>
<p><a href="#">PORTO / PORT / VINHO DO PORTO / PORT WINE / VIN DE PORTO / OPORTO / PORTVIN / PORTWEIN / PORTWIJN</a> (PDO-PT-A1540)</p>	 <p>(EUTM Nos 11 907 334 and 2 281 970)</p>
<p><a href="#">JAGNIĘCINA PODHALAŃSKA</a> (PGI-PL-0837)</p>	<p><b>JAGNIĘCINA Z PODHALA</b> (invented example) Adjective in the PGI → Noun in the EUTM</p>
<p><a href="#">IBIZA / EIVISSA</a> (PGI-ES-A0110)</p>	<p><b>IBICENCO</b> (invented example) Noun in the PGI → Adjective in the EUTM</p>

Under [Article 7\(1\)\(j\) EUTMR](#) , it is irrelevant whether or not there are other word or figurative elements that may give the trade mark distinctive character. The sign can be acceptable as a whole under [Article 7\(1\)\(b\) and \(c\) EUTMR](#) and can still be objected to (as in the cases above) under [Article 7\(1\)\(j\) EUTMR](#) .

If the mark consists solely of the GI, the EUTM also falls under [Article 7\(1\)\(c\) EUTMR](#) , since it is considered descriptive both of the geographical origin of the goods

and of their quality. This means that the Office's objection will **simultaneously** raise absolute grounds for refusal under both [Article 7\(1\)\(c\) and \(j\) EUTMR](#) .

While **restricting the relevant goods to a particular GI** is usually a means of waiving the objection under [Article 7\(1\)\(j\) EUTMR](#) (see [paragraph 5](#) below), it is irrelevant for [Article 7\(1\)\(c\) EUTMR](#) .

For example, an application for the word mark '[Bergerac](#)' for *wines* will simultaneously be objected to under both [Article 7\(1\)\(c\) and \(j\) EUTMR](#) : it consists solely of the PDO '[Bergerac](#)' and is therefore descriptive. If the goods are subsequently limited to '[Bergerac](#)' (*GI*) *wine* , the objection under [Article 7\(1\)\(j\) EUTMR](#) will be waived but the trade mark will still be descriptive and can be objected to under [Article 7\(1\)\(c\) EUTMR](#) .

In addition, there must be a **logical separation of the GI from the rest of the term** for it to be identifiable and liable to objection. In other words, a trade mark will not be liable to objection when it contains the GI as part of a word element that does not bring to the consumer's mind the product whose designation is protected. This is normally the case when the term has its own meaning.

Examples where an objection should not be raised: TORONTO (it does not evoke the PDO '[Toro](#)'), EXCAVADORA (it does not evoke the PDO '[Cava](#)'), IMPORT (it does not evoke the PDO '[Port](#)').

Examples where an objection was raised: TOROLOCO (fig.) uses and evokes the PDO '[Toro](#)' as found in decision [R 2462/2013-2](#) of 18/11/2014 and PARMATUTTO evokes the PGI '[Coppa di Parma](#)' and the PDO '[Prosciutto di Parma](#)' as found in decision [R 1900/2013-5](#) of 20/01/2014. See also IR No [1 384 844](#) MEZCALOSFERA DE MEZCALOTECA (fig.), received on 18/01/2018, against which an objection was raised as it contains the GI '[Mezcal](#)'. On the limits to the scope of protection, see [paragraph 4.5](#).

#### 4.1.1 Exploitation of the reputation of GIs

As a preliminary remark, GIs are considered to be **inherently reputed** because they offer a guarantee of quality due to their geographical provenance **by the mere fact of being registered**.

According to [Article 103\(2\)\(a\)\(ii\) of Regulation \(EU\) No 1308/2013](#), [Article 21\(2\)\(a\) of Regulation \(EU\) 2019/787](#) and [Article 13\(1\)\(a\) of Regulation \(EU\) No 1151/2012](#), registered names are protected against use that exploits, weakens or dilutes<sup>27</sup> the reputation of the protected name. This protection even extends to different products (12/06/2007, [T-53/04](#) – [T-56/04](#), [T-58/04](#) & [T-59/04](#), Budweiser, EU:T:2007:167, § 175) and to services.

However, and as mentioned under [paragraph 4](#), the scope of this protection must be read in line with the mandate contained in [Article 102 of Regulation \(EU\) No 1308/2013](#) and [Article 14 of Regulation \(EU\) No 1151/2012](#), which limit the **refusal of trade marks** to the grapevine products listed in the former Regulation's Annex VII, Part II,

---

<sup>27</sup> [Regulation \(EU\) 2019/787](#) only refers to use which exploits the reputation of the protected name.



and to the products of the same type, respectively. [Article 36 of Regulation \(EU\) 2019/787](#) does not contain a specific limitation to a product, but a systematic approach is applied by the Office. Therefore, **in the context of examining absolute grounds for refusal**, the protection of GIs under all EU regulations cannot extend to all possible products (for further information on goods for which an objection can be raised, see [paragraph 5](#)).

Nevertheless, any claim towards **non-comparable goods and services** can be put forward in the context of [Article 8\(6\) EUTMR](#) insofar as such use **exploits, weakens or dilutes the reputation of the protected name** (see the Guidelines, [Part C, Opposition, Section 6, Geographical indications \(Article 8\(6\) EUTMR\)](#)).

## 4.2 Misuse, imitation or evocation of a GI

Neither the EUTMR nor the EU regulations define the meaning of ‘misuse’, ‘imitation’ or ‘evocation’.

### 4.2.1 Misuse

In the absence of any guidance from the Court, the Office considers that an EUTM ‘misuses’ a GI when it provides false indications as to the geographical source of the goods, with the result that it benefits from the perceived quality of the GI.

The Office understands the concept of ‘misuse’ as covering both misuse by the mere fact that an application is being filed and misuse due to use of the trade mark in trade.

‘Misuse’ due to use in trade is more difficult to establish in an absolute grounds for refusal examination. The Office’s examination is an *ex parte* assessment, which normally takes place before the applicant has actually used the trade mark. Therefore, in most cases, it would be difficult for the Office to establish that the trade mark actually ‘misuses’ the GI.

### 4.2.2 Imitation/evocation

The mark ‘imitates’ (mimics, reproduces elements of, etc.), with the result that the product designated by the GI is ‘evoked’ (called to mind). The term ‘evocation’ requires less than ‘imitation’ or ‘misuse’ ([Opinion of Advocate General](#), 17/12/1998, [C-87/97](#), *Cambozola*, EU:C:1998:614, § 33). Nevertheless, the Office considers the terms ‘imitation’ and ‘evocation’ as two corollaries of essentially the same concept.

Moreover, there is ‘imitation’, in the common meaning of the term, where the trade mark is ‘intended to simulate or copy something else’, here the earlier GI (see decision of 30/11/2018, [R 0251/2016-1](#), § 135). By contrast, ‘evocation’ is objective. For its application there is no need to show that the owner of the mark intended to evoke the earlier GI or that any fault existed ([Opinion of Advocate General](#), 17/12/1998, [C-87/97](#), *Cambozola*, EU:C:1998:614, § 33; 09/09/2021, [C-783/19](#), *Champanillo*, EU:C:2021:713, § 68).

According to the Court, the decisive criterion for finding ‘evocation’ is whether, **‘when the consumer is confronted with a disputed designation, the image triggered directly in his mind is that of the product whose geographical indication is protected’** (07/06/2018, [C-44/17](#), SCOTCH WHISKY, EU:C:2018:415, § 51; 04/03/1999, [C-87/97](#), Cambozola, EU:C:1999:115, § 25; 26/02/2008, [C-132/05](#), Commission v Germany, EU:C:2008:117, § 44; 21/01/2016, [C-75/15](#), Viiniverla, EU:C:2016:35, § 21). Consumers must **establish a sufficiently clear and direct link** between the term used to designate the product and the product whose name is protected (21/01/2016, [C-75/15](#), Viiniverla, EU:C:2016:35, § 22; 07/06/2018, [C-44/17](#), SCOTCH WHISKY, EU:C:2018:415, § 53; 09/09/2021, [C-783/19](#), Champanillo, EU:C:2021:713, § 59). At the same time, it is necessary to take account of **the presumed expectation of the average consumer**, who is reasonably well informed and reasonably observant and circumspect. In particular, it is not enough if the term incorporated in the trade mark application evokes in the relevant public **some kind of association** with the protected geographical indication or the area relating thereto, because such association does not necessarily establish a sufficiently clear and direct link between that element and the indication concerned (07/06/2018, [C-44/17](#), SCOTCH WHISKY, EU:C:2018:415, § 53). It is important to emphasise that the finding of evocation is never automatic. There may be no evocation even if the EUTM incorporates part of the GI or if a visual and aural similarity and conceptual proximity is established.

Importantly, the EU regulations protect GIs throughout the territory of the European Union. As a result, the Court has ruled that, in order to guarantee effective and uniform protection of GIs in that territory, **the concept of the consumer must be considered to cover European consumers** and not merely consumers of the Member State in which the product giving rise to a possible evocation of the GI is manufactured (21/01/2016, [C-75/15](#), Viiniverla, EU:C:2016:35, § 27; 07/06/2018, [C-44/17](#), SCOTCH WHISKY, EU:C:2018:415, § 59; 09/09/2021, [C-783/19](#), Champanillo, EU:C:2021:713, § 63). Taking the Viiniverla case as an example, the possible evocation of the GI ‘[Calvados](#)’ by a Finnish manufacturer of a cider spirit named Verladós has to be assessed on the basis of a number of criteria (see below) with respect to European consumers, not only Finnish consumers. Likewise, in the ‘Scotch Whisky’ case, the Court of Justice held that the fact that the disputed designation referred to a place of manufacture that was known to consumers in the Member State where the product was manufactured was irrelevant for the purpose of assessing evocation, since GIs are protected throughout the territory of the European Union and all European consumers must be included in that exercise (07/06/2018, [C-44/17](#), SCOTCH WHISKY, EU:C:2018:415, § 59).

Furthermore, in the ‘Scotch Whisky’ case, the Court of Justice held that phonetic and visual similarity between the disputed designation and the GI is not an essential condition for establishing that there is an evocation; it is only one of the factors to be taken into account. Therefore, in the absence of any phonetic or visual similarity or partial incorporation of the GI in the trade mark applied for, the examination of evocation must take into account also any **conceptual proximity** between the GI and the disputed designation in the trade mark applied for.

There may be evocation where the EUTM contains an element that is **visually, aurally or conceptually similar** to the protected GI. This extends to the figurative elements of a sign, as confirmed by the Court of Justice, should those elements trigger directly in the consumer's mind the products whose names are registered (02/05/2019, [C-614/17](#), Queso Manchego, EU:C:2019:344, § 22, 32). In both instances, that of conceptual proximity or evocation through figurative elements, the finding of evocation will be unlikely because, as a matter of principle, evocation of the earlier GI is difficult to establish *ex officio* if there is no visual or aural similarity whatsoever between the earlier GI and the disputed element. Third party observations may help/assist the Office in drawing attention to such cases.

As indicated above, according to the Court (04/03/1999, [C-87/97](#), Cambozola, EU:C:1999:115; 26/02/2008, [C-132/05](#), Commission v Germany, EU:C:2008:117; 21/01/2016, [C-75/15](#), Viiniverla, EU:C:2016:35, § 21, cited above), the EUTM must trigger in the consumer's mind the image of the product whose designation is protected, in the sense that a link is established.

The concept of 'evocation' does not require, as a prerequisite, that the product covered by the GI and the goods or services covered by the contested sign be identical or similar. What has to be found, through a **global assessment** of all the factors relevant to the case, is that the relevant public establishes a **sufficiently clear and strong link** between the contested sign and the GI (09/09/2021, [C-783/19](#), Champanillo, EU:C:2021:713, § 66).

However, as mentioned under [paragraph 4](#), the scope of *ex officio* assessment must be read in line with the mandate contained in [Article 102 of Regulation \(EU\) No 1308/2013](#) and [Article 14 of Regulation \(EU\) No 1151/2012](#) which limit the **refusal of trade marks** to the grapevine products listed in its Annex VII, Part II, and to the products of the same type, respectively. [Article 36 of Regulation \(EU\) 2019/787](#) does not contain a specific limitation to a product, but a systematic approach is applied by the Office. Therefore, **in the context of examining absolute grounds for refusal**, the protection of GIs under all EU regulations cannot extend to all possible products (for further information on goods for which an objection can be raised, see [paragraph 5](#)). Nevertheless, any claim towards **non-comparable goods and services** can be put forward in the context of [Article 8\(6\) EUTMR](#) insofar as it can be shown that the contested sign **would take unfair advantage of the reputation of the protected name** (09/09/2021, [C-783/19](#), Champanillo, EU:C:2021:713, § 50). For further information see the Guidelines, [Part C, Opposition, Section 6, Geographical indications \(Article 8\(6\) EUTMR\)](#).

Importantly, evocation is **not assessed in the same way as likelihood of confusion**. Therefore, it is irrelevant whether a likelihood of confusion can be established or not in order to find that there is evocation of the GI. As the Court has held, there can be 'evocation' even in the absence of any likelihood of confusion (09/09/2021, [C-783/19](#), Champanillo, EU:C:2021:713, § 68 *in fine*). What matters, in particular, is that an association of ideas regarding the origin of the products is not created in the mind of the public, and that a trader does not take undue advantage of the reputation of the protected geographical indication (21/01/2016, [C-75/15](#), Viiniverla, EU:C:2016:35,

§ 45). For evocation, **a link must be made with the product whose designation is protected**. Therefore, whether or not there is evocation will not be analysed according to the principles laid down by the Court in its judgment of 11/11/1997, [C-251/95](#), Sabèl, EU:C:1997:528.

In assessing whether a sufficiently clear and direct link exists, the Court has considered that global assessment requires the following factors to be considered.

- The **partial incorporation** of the GI within the sign (09/09/2021, [C-783/19](#), Champanillo, EU:C:2021:713, § 55, 58, 66).
- Whether there is a **visual, phonetic or conceptual relationship** between the terms of the GI and the sign, and what kind of similarity stems from it:
  - e.g. if the terms share a characteristic beginning, such as Parmesan/Parmigiano Reggiano (26/02/2008, [C-132/05](#), Commission v Germany, EU:C:2008:117);
  - e.g. if the terms share characteristic roots or endings that have no particular meaning, such as in Gorgonzola/Cambozola (04/03/1999, [C-87/97](#), Cambozola, EU:C:1999:115) and Verlados/Calvados (21/01/2016, [C-75/15](#), Viiniverla, EU:C:2016:35);
  - e.g. if the terms share the same number of letters or syllables, such as Gorgonzola/Cambozola (04/03/1999, [C-87/97](#), Cambozola, EU:C:1999:115);
  - e.g. where there is conceptual proximity, such as between Parmesan and Parmigiano Reggiano (26/02/2008, [C-132/05](#), Commission v Germany, EU:C:2008:117, § 47); this includes situations where there is conceptual proximity but no visual or phonetic similarity (07/06/2018, [C-44/17](#), SCOTCH WHISKY, EU:C:2018:415, § 56).
- **The degree of proximity of the goods concerned** (09/09/2021, [C-783/19](#), Champanillo, EU:C:2021:713, § 66), including the actual physical appearance (04/03/1999, [C-87/97](#), Cambozola, EU:C:1999:115, § 27) or the ingredients and taste of the products covered by the EUTM and the GI. The fact that the goods are comparable does not, as such, lead automatically to the evocation of the GI. However, if the goods concerned are identical, this is an element in support of evocation (see [paragraph 4.2](#) ).
  - For instance, the expression 'POLISH TASTE' for *vodka* evokes the GI '[Polish vodka](#)'. However, the Office considers that the expression 'POLISH TASTE' for *whisky* does not evoke the GI '[Polska Wódka / Polish Vodka](#)', considering the differences between whisky and vodka. In other words, given the differences between whisky and vodka (e.g. different characteristics, ingredients and taste) and the fact that the GI '[Polska Wódka / Polish Vodka](#)' is not fully reproduced in the trade mark, the relevant consumers will not establish a link between a bottle of whisky marketed under the trade mark 'POLISH TASTE' and vodka protected by the GI '[Polska Wódka / Polish Vodka](#)'.
  - Similarly, the expression 'M. MÜLLER — ECHTE BAYERISCHE QUALITÄT VON BODENSEE' [M. Müller — Real Bavarian Quality from Lake Constance] for *beef* evokes the GI '[Bayerisches Rindfleisch / Rindfleisch aus Bayern](#)' (beef from Bavaria). However, the Office considers that the same expression for *poultry* will not evoke the GI '[Bayerisches Rindfleisch / Rindfleisch aus Bayern](#)'. The Office

considers that even if these are all ‘meat products’, when account is taken of the differences between beef and poultry and the fact that the GI ‘[Bayerisches Rindfleisch / Rindfleisch aus Bayern](#)’ is not fully reproduced in the trade mark, the relevant consumers will not establish a link between poultry meat marketed under the trade mark ‘M. MÜLLER — ECHTE BAYERISCHE QUALITÄT VON BODENSEE’ and beef protected by the designation ‘[Bayerisches Rindfleisch / Rindfleisch aus Bayern](#)’.

- **Reputation of the protected name** beyond the inherent reputation, and **the exploitation thereof**. According to the Court, the concept of ‘evocation’ establishes a wide-ranging protection that is intended to extend to all uses which take unfair advantage of the reputation enjoyed by the GI through association with it. This extensive protection is consistent with the broad scope of protection afforded to GIs and contributes to its achievement (09/09/2021, [C-783/19](#), Champanillo, EU:C:2021:713, § 50 and [Opinion of Advocate General](#), EU:C:2021:350, § 36, 37). However, the Office will assess any claim in reference to non-comparable goods and services in the context of [Article 8\(6\) EUTMR](#) (see the Guidelines, [Part C, Opposition, Section 6, Geographical indications \(Article 8\(6\) EUTMR\)](#)).
- The fact that the **context surrounding the element under assessment is not to be taken into account** (07/06/2018, [C-44/17](#), SCOTCH WHISKY, EU:C:2018:415, § 60). In particular, the fact that the EUTM contains indications of the true origin of the product or what are known as ‘delocalisers’ are not factors that will weigh against a finding of evocation (see [paragraph 4.4](#) et seq.).

*Examples of where evocation was found*

GI	EUTM	Explanation
<p><a href="#">SCOTCH WHISKY</a> (PGI-GB-01854)</p>	 (EUTM No 15 420 607)	<p>The country name Scotland is a noun that evokes the adjective ‘Scotch’, which forms part of the GI ‘<a href="#">Scotch Whisky</a>’.</p>

<p><a href="#">Λυγουριό Ασκληπιείου</a> / <a href="#">LYGOURIO ASKLIPIOU</a> (PDO-GR-0050)</p>	 (EUTM No 15 510 721)	<p>The term 'ASKLIPIOU', which forms part of the PDO '<a href="#">Λυγουριό Ασκληπιείου</a> / <a href="#">Lygourgio Asklipiou</a>', is the genitive case of the noun 'ASKLEPIOS' (or 'ASKLIPIOS'), which appears in the nominative case in the contested EUTM. The genitive case denotes, inter alia, origin and possession and in this case evokes the PDO. The figurative element is a visual repetition of the term as it consists of a typical representation of the ancient Greek god Asclepius.</p>
<p><a href="#">PORC DE NORMANDIE</a> (PGI-FR-0192) <a href="#">VOLAILLES DE NORMANDIE</a> (PGI-FR-0154) <a href="#">CAMEMBERT DE NORMANDIE</a> (PDO-FR-0112)</p>	 (EUTM No 17 772 401)	<p>The term Normandy will be linked with the French term 'Normandie'.</p>
<p><a href="#">CHAMPAGNE</a> (PDO-FR-A1359)</p>	 (EUTM No 17 962 122)	<p>The word element in the later trade mark can be seen as phonetically and visually similar to the term <a href="#">Champagne</a> and will have to be assessed for evocation.</p>
<p><a href="#">IRISH POTEEN / IRISH POITÍN</a> (PGI-IE+GB-02080) <a href="#">IRISH WHISKEY / UISCE BEATHA EIREANNACH / IRISH WHISKY</a> (PGI-IE+GB-01897) <a href="#">IRISH CREAM</a> (PGI-IE+GB-02057)</p>	<p><b>Irish Monk</b> (EUTM No 017 496 308)</p>	<p>Reference to 'Irish' as seen in this later trade mark will have to be assessed for evocation against the registered GIs containing the same term.</p>



<p><u>TIERRA DEL VINO DE ZAMORA</u> (PDO-ES-A0634)</p>	 (EUTM No 17 009 127)	<p>The term Zamora is clearly visible in both the GI and the later trade mark, and an assessment for evocation will have to be carried out.</p>
--	---	---

*Examples of where evocation was not found*

GI	EUTM	Explanation
<p><u>VINHO VERDE</u> (PDO-PT-A1545)</p>	<p>VERDI EUTM No 15 080 278</p>	<p>Due to the clear conceptual meaning of the designation 'VERDI', the relevant public will not be led to believe that the aforementioned designation depicts the PDO in question.</p> <p>The presence of a partial correlation in the present case between the terms 'VERDI' on the one hand, and 'VERDE' on the other, is not sufficient to offset the fact that the consumer of the goods in question will perceive the sign 'VERDI' as a clear reference to the Italian opera composer.</p> <p>(06/04/2017, <a href="#">R 1972/2016-5</a>, VERDI, § 12 and 14)</p>
<p><u>CAPE GIRARDEAU COUNTY (OZARK MOUNTAIN)</u> (Non-EU-country GI) (United States of America)</p>	 EUTM No 16 081 614	<p>The mark contains the term 'craft beer'. Therefore, it is unlikely that it will be perceived as evoking a GI relating to wine.</p> <p>Moreover, 'Cape' by itself is not, on its own, the significant part of the GI. Therefore, in order to evoke the GI, reference to the other geographically significant part of the GI (e.g. 'Girardeau') is necessary.</p>

<p><a href="#">ROSÉE DES PYRÉNÉES CATALANES</a> (PGI-ES+FR-1343)</p>	 <p>EUTM No 17 371 063</p>	<p>The fact that the trade mark contains the generic term Rosée does not in itself lead to an evocation of the PGI referred to.</p>
<p><a href="#">LAVILLEDIEU</a> (PGI-FR-A1136)</p>	<p>Laville Pavillon EUTM No 10 961 785</p>	<p>The mere reference to Laville is not sufficient to trigger in the public's mind a link with the PGI '<a href="#">Lavilledieu</a>'. As many municipalities start with the term 'Laville', this term is commonly used and no direct link can be established with any particular GI product.</p>
<p><a href="#">ISOLA DEI NURAGHI</a> (PGI-IT-A1140) <a href="#">S. ANNA DI ISOLA CAPO RIZZUTO</a> (PDO-IT-A0629)</p>	 <p>EUTM No 17 626 664</p>	<p>'ISOLA BIANCA' means 'WHITE ISLAND'. Although 'ISOLA' appears in the GIs '<a href="#">Isola dei Nuraghi</a>' and '<a href="#">S. Anna di Isola Capo Rizzuto</a>', the term 'ISOLA' cannot by itself evoke those GIs as the term 'ISOLA' itself is a common term referring merely to an island as such.</p>
<p><a href="#">PORTOFINO / GOLFO DEL TIGULLIO - PORTOFINO</a> (PDO-IT-A0355)</p>	 <p>EUTM No 17 960 157</p>	<p>The mark contains the term 'gin'. Therefore, it is unlikely that it will be perceived as evoking a PDO relating to wine.  The EUTM is acceptable since the logical and conceptual unit translates as gin from Portofino, which precludes the evocation of the PDO, as a new distinct conceptual unit emerges for the European public.</p>

### 4.3 Other misleading indications and practices

[Article 103\(2\)\(c\) and \(d\) of Regulation \(EU\) No 1308/2013](#), [Article 21\(2\)\(c\) and \(d\) of Regulation \(EU\) 2019/787](#) and [Article 13\(1\)\(c\) and \(d\) of Regulation \(EU\)](#)



[No 1151/2012](#) protect PDOs/PGIs against a number of false or misleading indications about the origin, nature or essential qualities of products.

In the ‘Scotch Whisky’ judgment, the Court (07/06/2018, [C-44/17](#), SCOTCH WHISKY, EU:C:2018:415, § 61-71) addressed the issue of misleading indications. There are two points to be considered:

- an indication may be considered misleading if it includes information, inter alia in the form of words or an image, that is **capable of providing information** on the provenance, origin, nature or essential qualities of that product (§ 66);
- **the context** in which the possible misleading indication is used is not to be taken into account (§ 63).

The Office would, therefore, have to establish whether or not an indication (an element in the trade mark) is ‘liable to convey a false impression as to [the product’s] origin’ (07/06/2018, [C-44/17](#), SCOTCH WHISKY, EU:C:2018:415, § 66-67) or to the nature or essential qualities of the product (20/12/2017, [C-393/16](#), CHAMPAGNE, EU:C:2017:991, § 64).

Given the inherent difficulty in identifying and assessing such possible indications, the Office will rely principally on observations by third parties.

Nevertheless, it should be borne in mind that this situation of ‘misleading indications and practices’ will mainly refer to cases where the term/‘indication’ is already assessed under the ground of either use, misuse, imitation or evocation as part of the absolute grounds examination. As the Court found in the ‘CHAMPAGNE’ case, use of a PDO ‘[Champagne](#)’ might simultaneously fall under ‘use’ and be considered ‘a misleading indication’ (20/12/2017, [C-393/16](#), CHAMPAGNE, EU:C:2017:991, § 53, 63).

## 4.4 Additional considerations

When applying [Article 7\(1\)\(j\) EUTMR](#), the mere fact that the GI is used in translation or that there is a ‘delocaliser’ in the EUTM will be considered irrelevant. EU regulations with respect to GIs clearly and explicitly refer to such ‘uses’ as prohibited. Where the applicant has its legal seat is likewise irrelevant for the purposes of applying [Article 7\(1\)\(j\) EUTMR](#). Additionally, the argument that a GI is not known to the relevant public cannot succeed against an objection under [Article 7\(1\)\(j\) EUTMR](#).

### 4.4.1 Translations

The protection conferred on a GI applies ‘even if’ the protected indication is used in a translated form. It is therefore irrelevant whether or not the disputed name constitutes an exact translation of the protected GI ([26/02/2008, C-132/05, Commission v Germany, EU:C:2008:117, § 47](#)).

GI	EUTM	Explanation
----	------	-------------

<p><b><u>BOURGOGNE</u></b> (PDO-FR-A0650)</p>	 <p>EUTM No 2417269</p>	<p>'Borgoña' is the Spanish translation of the French PDO '<u>Bourgogne</u>'.</p>
<p><b><u>PÂTES D'ALSACE</u></b> (PGI-FR-0324)</p>	<p><b>ALSATIAN PASTA</b> (invented example)</p>	<p>An EUTM that contains the expression 'Alsatian Pasta' will be considered as 'using' the PGI '<u>Pâtes d'Alsace</u>'.</p>

Trade marks consisting of these translated terms must be refused under both [Article 7\(1\)\(c\) and \(j\) EUTMR](#) rather than solely under [Article 7\(1\)\(c\) EUTMR](#).

On the one hand, it follows that the fact that a disputed name contained in an EUTM is a translation of a protected GI cannot be raised as a valid defence by the applicant or proprietor. On the other hand, this implies that the Office will object to translations of GIs **only to the extent** that the translation amounts to use, misuse or evocation of a GI. Accordingly, no objection will be raised if the translation at issue does not trigger a sufficiently clear and direct link in the consumer's mind with a product whose designation is protected.

For instance, '[TORO](#)' is a Spanish PDO for wines from the region of Toro but the Office will not object under [Article 7\(1\)\(j\) EUTMR](#) to the term 'BULL' just because it is the English equivalent to the Spanish word 'TORO'. This is because the European consumer will always refer to the wine as TORO wine (it will never be 'bull' wine, even for English speakers). Once translated, the geographical reference and hence the link with the particular product is immediately lost as, in this particular case, the term 'bull' would not convey any link with the PDO '[Toro](#)'.

#### 4.4.2 Use of delocalisers

According to [Article 103\(2\)\(b\) of Regulation \(EU\) No 1308/2013](#), [Article 21\(2\)\(b\) of Regulation \(EU\) 2019/787](#) and [Article 13\(1\)\(b\) of Regulation \(EU\) No 1151/2012](#), GIs are protected 'even if ... the protected name is ... accompanied by an expression such as "style", "type", "method", "as produced in", "imitation" ... or similar'.

Therefore, the fact that the GI reproduced or evoked in the EUTM is accompanied by these expressions does not rule out application of [Article 7\(1\)\(j\) EUTMR](#).

In other words, **even if the public is thereby informed about the actual origin of the product, an objection will still be raised** under [Article 7\(1\)\(j\) EUTMR](#). Notwithstanding this, the trade mark will be **misleading** under [Article 7\(1\)\(g\) EUTMR](#) since there is a contradiction between the goods (restricted to the specific GI) and the message conveyed by the mark (that the goods are not 'genuine' GI products), which will thus necessarily lead to a further objection under that article.

PDO/PGI	EUTM (invented examples)	Explanation
<a href="#">RIOJA</a> (PDO-ES-A0117)	<b>RIOJA STYLE RED WINE</b>	An EUTM that contains an expression such as 'Rioja Style Red Wine' will be considered unacceptable even if it conveys the idea that the product in question is not a 'genuine' PDO <a href="#">Rioja</a> wine.
<a href="#">Φέτα / FETA</a> (PDO-GR-0427)	<b>GREEK STYLE PLAIN FETA</b> <b>ARABIAN FETA</b>	An EUTM that contains expressions such as 'Greek Style Plain Feta' or 'Arabian Feta' will be considered unacceptable even if it conveys the idea that the product in question is not a 'genuine' PDO <a href="#">Φέτα / Feta</a> cheese.

#### 4.4.3 Location of the applicant's legal seat

Where the applicant has its legal seat is irrelevant for assessing [Article 7\(1\)\(j\) EUTMR](#). [Article 103\(1\) of Regulation \(EU\) No 1308/2013](#) and [Article 12\(1\) of Regulation \(EU\) No 1151/2012](#) set out that GIs may be used by any operator marketing a product that conforms to the corresponding specification. Hence, provided that the goods comply with the specification of the GI in question (which is guaranteed by restricting the goods appropriately), **the location of the applicant's legal seat as indicated in the EUTM application is irrelevant**. For example, a company with legal domicile in Poland can own a vineyard located in Spain that produces *wine* complying with the product specification of the PDO '[Ribera del Duero](#)'. Similarly, a company with legal domicile in Lithuania can own a factory located in Spain that prepares products complying with the PGI '[Chorizo de Cantimpalos](#)'.

#### 4.4.4 GIs not known to the public

Any contention that the protected GI reproduced in or evoked by the EUTM is unknown to the relevant public or has no reputation must be dismissed as irrelevant. This is in particular because the reputation of a GI is not a condition for its protection (02/02/2017, [T-510/15](#), TOSCORO, EU:T:2017:54, § 48). It has to be understood as absolute protection given to any registered GI name. The starting premise of the assessment under [Article 7\(1\)\(j\) EUTMR](#) is that every registered GI is, as a fact, known to the relevant public as a GI.

This also stems, more fundamentally, from the essential function of a GI, which is to guarantee to consumers the geographical origin of the goods and the specific qualities inherent in them (29/03/2011, [C-96/09 P](#), Bud, EU:C:2011:189, § 147). For more on inherent reputation of a GI in terms of quality, see [Guidelines, Part C, Opposition, Section 6, Geographical indications \(Article 8\(6\) EUTMR\)](#). The Court has already confirmed that the system of registration for GIs ‘seeks to contribute [...] not only to the prevention of deceptive practices and the attainment of market transparency and fair competition, but also to the attainment of a high level of consumer protection’. Therefore, what the Office will take into account is the presumed reaction/expectation of the average consumer, who is reasonably well informed and reasonably observant and circumspect (21/01/2016, [C-75/15](#), Verlados, EU:C:2016:35, § 24-25).

## 4.5 Limits to the scope of protection

### 4.5.1 Elements that will not be afforded protection

If a GI contains more than one element within its name (i.e. the indication of a type of a product and the geographical reference, or a grape variety and the geographical reference), some of which would be considered **descriptive or generic**, protection does not extend to the descriptive/generic element (see [Article 13\(1\) of Regulation \(EU\) No 1151/2012 in fine](#) and judgment of 12/09/2007, [T-291/03](#), Grana Biraghi, EU:T:2007:255, § 58, 60).

#### 4.5.1.1 Descriptive elements within the meaning of Article 7(1)(c) EUTMR

No objection will be raised to the mere fact that an EUTM contains a descriptive element that is part of a GI. Examples include the GIs ‘[Maçã de Alcobça](#)’ (‘maçã’ is the Portuguese word for apple) and ‘[Jambon d’Ardenne](#)’ (‘jambon’ is the French word for ham).

Where the descriptive nature of an element in a GI can be determined by standard dictionary definitions, the perspective of the public in the country of origin of the GI is determinative. For instance, it suffices that the term ‘maçã’ will be perceived by Portuguese-speaking consumers as denoting a fruit for it to be concluded that it is descriptive, regardless of whether or not it can be understood by other parts of the public in the European Union.

By contrast, where no definition can be found in a standard, well-known dictionary, the descriptive nature of the term in question should be assessed following the criteria laid down by the Court, such as relevant national and EU legislation, how the term is perceived by the public, and circumstances relating to the marketing of the product in question (26/02/2008, [C-132/05](#), Commission v Germany, EU:C:2008:117; 12/09/2007, [T-291/03](#), Grana Biraghi, EU:T:2007:255).

#### 4.5.1.2 Generic terms within the meaning of Regulation (EU) No 1151/2012

Pursuant to [Article 3\(6\) of Regulation \(EU\) No 1151/2012](#), “generic terms” means the names of products which, although relating to the place, region or country where the product was originally produced or marketed, have become the common name of a product in the Union.’

The Court of Justice has referred to the terms ‘camembert’ and ‘brie’ as examples of generic terms (26/02/2008, [C-132/05](#), Parmigiano Reggiano, EU:C:2008:117, § 36). See the PDOs ‘[Camembert de Normandie](#)’ (PDO-FR-0112), ‘[Brie de Meaux](#)’ (PDO-FR-9110) and ‘[Brie de Melun](#)’ (PDO-FR-0111).

Other examples are ‘cheddar’ and ‘gouda’ (see Regulation (EC) No 1107/96, footnotes to the PDOs ‘[West Country farmhouse Cheddar cheese](#)’ and ‘[Noord-Hollandse Gouda](#)’).

When terms have been declared to be ‘generic’ by the EU judicature or legislation, no objection will be raised. The following ‘cheese’ references are considered generic in the EU: brie, camembert, cheddar, edam, emmental and gouda (see [https://ec.europa.eu/commission/presscorner/detail/en/IP\\_96\\_153](https://ec.europa.eu/commission/presscorner/detail/en/IP_96_153)).

GI	EUTM
<p>(none, because ‘camembert’ is not a geographical indication, but a generic term)</p>	 <p>(EUTM No 7 389 158)</p>

#### 4.5.2 Terms commonly used in trade

In addition, if a GI contains or evokes a term that is **commonly used in trade** (and is **not** protected as a **traditional term for wine** or as a **traditional speciality guaranteed**) to designate the goods concerned, objections should not automatically be raised against trade marks referring to that term (e.g. ‘Torre’, see judgments of 18/12/2008, [T-287/06](#), Torre Albéniz, EU:T:2008:602, § 58; 11/07/2006, [T-247/03](#), Torre Muga, EU:T:2006:198, § 57). In particular, the Office will assess whether, by including the terms in the sign, the image triggered in the mind of the consumer is that of the product whose designation is protected.

GI	EUTM	Explanation
<p><a href="#">CASTELLÓ</a> (PGI-ES-A1173) for <i>wines</i></p>	<p><b>CASTELL DE LA BLEDA</b> for <i>wines</i> EUTM No 14 202 808</p>	<p>In the <i>wine</i> sector, the term ‘castello’ (without accent, castle in Italian) is frequently used.</p> <p>It is considered that the term ‘CASTELL’ does not constitute, strictly speaking, an evocation of the PGI in question. While it is admitted that the difference is only in one letter, terms such as ‘castillo/castello’, ‘torre’, etc. are commonly used in the presentation of <i>wines</i>. In view of this, it is unlikely that the relevant consumers would associate the EUTM in question with the <i>wines</i> protected under the PGI. It is rather more likely that they will first make an immediate association with a common term in the marketing of <i>wines</i>.</p>

GI	EUTM	Explanation
<p><a href="#">CAVA</a> (PDO-ES-A0735) for <i>wines</i></p>	 <p>EUTM No 11 345 824 for <i>wines</i></p>	<p><a href="#">T-774/16</a> (12/07/2018, <b>EU:T:2018:441</b>, § 37-67)</p> <p>The reference to ‘CAVE’ in the trade mark will not trigger a link with the PDO <a href="#">‘CAVA’</a> as, considering the other elements of the trade mark and in particular the inherent meaning of the terms ‘CAVA/CAVE’ in Spanish and French as referring to ‘a wine cellar’, the possibility of evocation of the PDO <a href="#">‘CAVA’</a> is precluded following a global assessment.</p>

### 4.5.3 Logical and conceptual unit

Objections should not be raised because of the mere presence of a GI in a trade mark application if that mark, taken as a whole, forms a logical and conceptual unit, the meaning of which, in relation to the products concerned, neither evokes nor imitates the earlier GI.

Even the Court has confirmed that ‘possible information capable of indicating that the visual and phonetic relationship between the two names is not fortuitous’ should be taken into account (21/01/2016, [C-75/15](#), *Verlados*, ECLI:EU:C:2016:35, § 39-40). Therefore, similarity between terms may have occurred by chance as use of a term may be justified linguistically, irrespective of its similarity to the registered GI. For example, words in different languages may have a similar visual or phonetic appearance, but nothing more in common due to their inherent meaning.

When assessing the possible use/evocation of a GI within an EUTM, the fact that some GIs may have an inherent meaning distinct from the reference to a geographical place will be taken into account.

On the basis of the criteria mentioned above, a GI that coincides with **surnames or family names** is, when used in combination with other elements, unlikely to remind the relevant consumer of the product protected under the relevant GI. Again, objections should not automatically be raised just because of the presence of a GI term in the trade mark. For instance, the term ‘Leon’ is included in the PDO ‘[Tierra de León](#)’ and the PGI ‘[Castilla y León](#)’, both for *wines*. However, in combination with a first name, it is more likely to be perceived as a family name rather than an indication of geographical origin (25/04/2012, [R 2274/2011-4](#), MICHEL LEON).

The term ‘Lorenzo’ is included in the PDO ‘[Castel San Lorenzo](#)’ for *wines*. However, in combination with other elements, it is more likely to be perceived as a first name rather than an indication of geographical origin. See EUTM No 14 095 228 Organic Casa Lorenzo (fig.).

The assessment is to take into account the perception of the relevant public when it comes to logical and conceptual units that should not be artificially dissected.

In a case concerning a conflict between the trade mark application PORT CHARLOTTE for *whisky* and the earlier PDO ‘[Porto / Port / vinho do Porto / Port Wine / vin de Porto / Oporto / Portvin / Portwein / Portwijn](#)’, the General Court, in a judgment confirmed by the Court of Justice, held that the sign PORT CHARLOTTE, read as a whole as a logical and conceptual unit, would be understood by the relevant public as designating a harbour named after a person called Charlotte, with no direct link being made with the PDO ‘[Porto / Port / vinho do Porto / Port Wine / vin de Porto / Oporto / Portvin / Portwein / Portwijn](#)’. Even though the term ‘port’ forms an integral part of the contested mark, the average consumer, even if he or she is of Portuguese origin or speaks Portuguese, will not, on encountering a *whisky* bearing that mark, associate it with a port wine covered by the designation of origin in question (18/11/2015, [T-659/14](#), PORT CHARLOTTE, EU:T:2015:863, § 71; 14/09/2017, [C-56/16 P](#), PORT CHARLOTTE, EU:C:2017:693, § 124).



In some cases, the goods applied for may play a decisive role as well.

The 'logical and conceptual unit' approach will lead to no objection in examples such as these below.

GI	EUTM	Explanation
<p><a href="#">ALBA</a> (PDO-IT-A1063) for <i>wines</i></p>	 <p><b>DANIEL ALBA</b> B O D E G A S</p> <p>EUTM No 14 955 736 for <i>wines</i></p>	<p>The reference to 'ALBA' in the trade mark will not trigger a link with the PDO '<a href="#">ALBA</a>' as, considering the other elements of the trade mark and in particular the common first name 'Daniel', it is likely to be understood as a surname.</p>

GI	EUTM	Explanation
----	------	-------------



<p><a href="#">PORTO / PORT / VINHO DO PORTO / PORT WINE / VIN DE PORTO / OPORTO / PORTVIN / PORTWEIN / PORTWIJN</a> (PDO-PT-A1540) for <i>wines</i></p>	<p><b>PORT CHARLOTTE</b> EUTM No 5 421 474 for <i>whisky</i></p>	<p><a href="#">C-56/16 P</a> (14/09/2017, PORT CHARLOTTE, EU:C:2017:693, § 115-116, 124)</p> <p>§ 115 ‘The incorporation in a trade mark of a name which is protected under Regulation No 1234/2007, such as the designation of origin “<a href="#">port</a>”, cannot be held to be capable of exploiting the reputation of that designation of origin, for the purposes of Article 118m(2)(a)(ii) of that regulation, if that incorporation does not lead the relevant public to associate that mark or the goods in respect of which it is registered with the designation of origin concerned or the wine product in respect of which it is protected.’</p> <p>§ 116 ‘[...] that the sign “PORT CHARLOTTE”, since it consists of the term “port” and the first name Charlotte, will be perceived by the relevant public as a logical and conceptual unit referring to a harbour, that is to say a place situated on the coast or on a river, with which a first name, which constitutes the most important and most distinctive element in the contested mark, is associated. According to the General Court, the relevant public will not perceive, in that sign, any geographical reference to the port wine covered by the designation of origin in question.’</p> <p>§ 124 ‘The General Court, without erring in law, applied the fundamental criterion deriving from that case-law, by holding, in paragraph 76 of the judgment under appeal, that, having regard to the findings set out in paragraph 71 of that same judgment, even though the term “port” forms an integral part of the contested mark, the average consumer, even if he is of Portuguese origin or speaks Portuguese, in reaction to a whisky bearing that mark, will not associate it with a port wine covered by the designation of origin in question.’</p>
--	--	--

GI	EUTM	Explanation
----	------	-------------

<p><b><u>PENISOLA SORRENTINA</u></b> (PDO-IT-1546) for <i>olive oil</i></p> <p><b><u>LIMONE DI SORRENTO</u></b> (PGI-IT-0098) for <i>lemons</i></p>	 <p>EUTM No 17 887 237 for goods in Classes 29, 30 and services in Class 35</p>	<p>The EUTM is acceptable because the logical and conceptual unit translates as 'Dairy factory in/of Sorrento', which precludes the evocation of the two GIs and is a new distinct conceptual unit for the Italian public. For the part of the public that does not understand this unit, other elements of the mark will be overwhelmingly different to those of the two GIs, with the result that there will be no evocation.</p>
---	--	---

#### 4.5.4 Names of countries, regions

There are a number of GIs for *spirit drinks* where the geographically significant part of the GI **refers to a whole country**, for example: '[Polska Wódka / Polish Vodka](#)'; '[Suomalainen Vodka / Finsk Vodka / Vodka of Finland](#)'; '[Svensk Vodka / Swedish Vodka](#)'; '[Originali lietuviška degtinė / Original Lithuanian vodka](#)'; '[Estonian vodka](#)'; '[Brandy italiano](#)'; '[Irish Whiskey / Uisce Beatha Eireannach / Irish Whisky](#)'.

Such GIs deserve the protection afforded by [Regulation \(EU\) 2019/787](#). However, the Office considers that the geographical part of the GIs is indissolubly linked to the remaining elements of the GI. In this sense, protection of the GIs does not automatically extend to prohibitions of use of the name of the country or of its adjective for **any** spirit drink or, more broadly, any alcoholic beverage.

Consequently, when examining EUTMs applied for in respect of goods in Class 33 *alcoholic beverages* that include a term referring to a particular country (e.g. Finland) or its adjective (e.g. Finnish) in connection with which there is a registered GI (e.g. '[Suomalainen Vodka / Finsk Vodka / Vodka of Finland](#)' ), the Office considers that the inclusion of the country reference or its adjective in the EUTM triggers in the consumer's mind a link with the product whose designation is protected only for **products of the same category** (e.g. *vodka* ) and not for comparable goods.

GI	EUTM	Explanation
----	------	-------------

<p><a href="#">Suomalainen Vodka / Finsk Vodka / Vodka of Finland</a> (PGI-FI-02040)</p>	<p><b>FINNISH TASTE</b> (fig.) for alcoholic beverages (invented example)</p>	<p>The EUTM is acceptable for '<a href="#">Suomalainen Vodka / Finsk Vodka / Vodka of Finland</a>' (GI) vodka; beverages based on '<a href="#">Suomalainen Vodka / Finsk Vodka / Vodka of Finland</a>' (GI) vodka and for any other <b>specific</b> alcoholic beverages, for instance:</p> <ul style="list-style-type: none"> <li>- '<a href="#">Suomalainen Vodka / Finsk Vodka / Vodka of Finland</a>' (GI) vodka; beverages based on '<a href="#">Suomalainen Vodka / Finsk Vodka / Vodka of Finland</a>' (GI) vodka ; whisky .</li> <li>- alcoholic beverages except vodka and beverages based on or containing vodka.</li> </ul> <p>The following limitation is, however, <b>not acceptable</b> : '<a href="#">Suomalainen Vodka / Finsk Vodka / Vodka of Finland</a>' (GI) vodka; other alcoholic beverages .</p> <p>The reference to 'other alcoholic beverages' would include vodka that does not comply with the GI specifications.</p>
--	---	--

There are also GI names that, for example, all protect the same type of product, and whose names refer to different areas within a greater region.

GI	EUTM	Explanation
----	------	-------------

<p><a href="#">Alpes-de-Haute-Provence</a> (PGI-FR-A1115)</p> <p><a href="#">Coteaux d'Aix-en-Provence</a> (PDO-FR-A0159)</p> <p><a href="#">Coteaux Varois en Provence</a> (PDO-FR-A0725)</p> <p><a href="#">Côtes de Provence</a> (PDO-FR-A0392)</p> <p><a href="#">Les Baux de Provence</a> (PDO-FR-A0272)</p> <p>All for <i>wines</i></p>	<p><b>Memories of Provence</b> for <i>alcoholic beverages</i> (invented example)</p>	<p>No objection will be raised as it would be difficult to establish a sufficiently clear and direct link with a particular <i>wine</i> . It follows from market reality that many products (in this example other <i>wines</i>) are produced within a particular region, but not all references to a particular region are to be seen as use of references to a GI.</p>
---	--	--

GI	EUTM	Explanation
<p><a href="#">Huile d'olive de Haute-Provence</a> (PDO-FR-0110)</p> <p><a href="#">Huile d'olive d'Aix-en-Provence</a> (PDO-FR-9111)</p> <p>Both for <i>olive oils</i></p>	<p><b>Taste of Provence</b> applied for <i>edible oils</i> (invented example)</p>	<p>No objection will be raised as it would be difficult to establish a sufficiently clear and direct link with a particular <i>olive oil</i> . It follows from market reality that many agricultural products (in this example other <i>olive oils</i>) are produced within a particular region, but not all references to a particular region are to be seen as use of references to a GI.</p>

Should an EUTM include an element that simply refers to a broader region, no objection will be raised, in principle, as it would be difficult to establish a sufficiently clear and direct link with a particular product. It follows from market reality that many agricultural products are produced within a particular region, but not all references to a particular region are to be seen as use of references to a GI. Nevertheless, this will not preclude an objection being raised under [Article 7\(1\)\(c\) EUTMR](#) , depending on the other elements in the EUTM.

Some of the examples might include references such as ‘Agricoltori di Toscana’ / ‘Tuscan farmers’, or ‘biodiversita di Sicilia’ / ‘Sicilian biodiversity’, whereby the use of ‘Tuscany’ and ‘Sicily’ is understood as a mere geographical reference to the region and not as a qualified GI, which would point to a specific product.

According to the case-law, ‘some kind of association with the protected geographical indication or the geographical area relating thereto... cannot be used [as justification for

an objection], as it does not establish a sufficiently clear and direct link between that element and the indication concerned' (07/06/2018, [C-44/17](#) , SCOTCH WHISKY, EU:C:2018:415, § 53). Should such an element be present within an EUTM, it will be considered a mere reference to geographical provenance but not to a GI.

For the use of 'geographical terms' see the Guidelines, [Part B, Section 4, Absolute Grounds for Refusal, Chapter 4, Descriptive Trade Marks \(Article 7\(1\)\(c\) EUTMR\)](#) .

## 4.6 Trade marks in conflict with two or more GIs

In some cases an EUTM application may constitute use or evocation of more than one GI at the same time. This is likely to happen when the EUTM application contains an element (not a generic one) that appears in more than one GI.

In these cases, provided that the EUTM application covers the relevant goods, an objection should be raised for all the GIs.

1. Where there is use/evocation of two or more GIs relating to **clearly distinct geographical areas, irrespective of the GI products, limitation of the goods will not be possible, and the application will be refused.**
2. Where there is use/evocation of two or more GIs relating to **overlapping geographical areas and the goods are identical** , the objection may (to the extent possible under relevant EU regulations) be overcome by limiting the goods to the smaller geographical area (e.g. in the wine sector, it is common to find smaller geographical areas being protected as a GI within a bigger geographical area which is also a GI). In such cases, limitation to 'a smaller GI' will not be seen as a conflict with the other geographical reference as, under the labelling rules, both references may co-exist on the label. The Office will always rely on the applicant to provide justification in such cases. Where the goods are different, the objection can be overcome by limiting the goods to the respective GIs if use/evocation is established.
3. Where there is use of two or more GIs relating to **the same geographical area** , the objection can be overcome by limiting the goods to respective GIs and by deleting the deceptive goods. Where two or more GIs relate to the same product, the applicant may be allowed to limit the goods to one, several or all of the GIs.

*Examples of situation No 1*

GI	EUTM	Explanation
<p><a href="#">RIOJA</a> (PDO-ES-A0117)</p> <p><a href="#">SANTIAGO</a> (Chilean PGI) both for <i>wines</i></p>	<p><b>RIOJA SANTIAGO</b></p> <p>EUTM No 8 237 224 for <i>wines</i> in Class 33</p>	<p>RIOJA SANTIAGO (28/04/2010, <a href="#">R 53/2010-2</a> )</p> <p>The trade mark applied for consists of the terms 'RIOJA' and 'SANTIAGO', each of which coincides with a PDO for <i>wines</i> , the former (<a href="#">RIOJA</a>) being protected by the European Union and the latter (<a href="#">SANTIAGO</a>), a geographical indication for a <i>wine</i> originating from Chile, being protected under a bilateral agreement between the European Union and the Republic of Chile.</p> <p>It is not possible to accept any limitation that includes <i>wine</i> originating from the territory of one of the two designations of origin since such a limitation automatically excludes <i>wines</i> originating from the other designation of origin, which inevitably means that the trade mark applied for will lead to confusion. By the same token, a hypothetical limitation of the list of goods to <i>wine</i> from the geographical area covered by either of the designations of origin, e.g. ' <i>wines</i> from the <a href="#">Rioja</a> designation of origin and <i>wines</i> from the <a href="#">Santiago</a> designation of origin', in Class 33, would be covered by the prohibition of <a href="#">Article 7(1)(j) EUTMR</a> insofar as the trade mark would inevitably –and confusingly – identify <i>wines</i> with a geographical origin other than that of the respective designations of origin included under the trade mark. Preventing such an eventuality is the principal purpose of that Article.</p>

GI	EUTM	Explanation
<p><a href="#">MOJAMA DE BARBATE</a> (PGI-ES-01211)</p> <p><a href="#">MOJAMA DE ISLA CRISTINA</a>(PGI-ES-01210) Both for <i>mojama</i></p>	 <p>EUTM No 16 842 254 for <i>mojama</i> in Class 29</p>	<p>'<a href="#">Mojama de Barbate</a>' and '<a href="#">Mojama de Isla Cristina</a>' are two different PGIs for 'mojama', the major difference being geographical origin (Cádiz and Huelva, respectively).</p> <p>It is not possible to accept any limitation that includes 'mojama' originating from the territory of one of the two PGIs since such a limitation automatically excludes 'mojama' originating from the territory of the other PGI, which inevitably means that the trade mark applied for will lead to confusion.</p>

### Examples of Situation No 2

GI	EUTM	Explanation
<p><a href="#">CÔTES DU RHÔNE</a> (PDO-FR-A0325)</p> <p><a href="#">VACQUEYRAS</a> (PDO-FR-A0151) Both for <i>wine</i></p>	 <p>EUTM No 17 917 599 for <i>wines</i> in Class 33</p>	<p>A limitation can be introduced for the smaller GI. The public will not be deceived as to the geographical origin of the products as this is allowed by the labelling rules.</p> <p>The EUTM was registered with the following limitation: Class 33: <i>Wine complying with the specifications of the protected designation of origin '<a href="#">Vacqueyras</a>'</i> . The limitation '<a href="#">Vacqueyras</a>' (GI) <i>wine</i> is also acceptable.</p>

### Examples of situation No 3

GI	EUTM	Explanation
<p><a href="#">TORO</a> (PDO-ES-A0886) for <i>wine</i></p> <p><a href="#">QUESO ZAMORANO</a> (PDO-ES-0089) for <i>cheese</i></p>	<p><b>TORO ZAMORANO</b> (invented) for <i>wines</i> in Class 33 and <i>cheese</i> in Class 29</p>	<p>Toro is a region within the province of Zamora. The sign reproduces in its entirety the PDO '<a href="#">Toro</a>' and uses part of the PDO '<a href="#">Queso Zamorano</a>'.</p> <p>A limitation should be introduced for both '<a href="#">Toro</a>' (GI) <i>wine</i> and '<a href="#">Queso Zamorano</a>' (GI) <i>cheese</i> .</p>

GI	EUTM	Explanation
<p><a href="#">Sobrasada de Mallorca</a> (PGI-ES-0097) for <i>sausage</i></p> <p><a href="#">Ensaïmada de Mallorca / Ensaïmada mallorquina</a> (PGI-ES-0277) for <i>pastry</i></p>	<p><b>MALLORCA SUN</b> (invented) for <i>meat, eggs</i> <i>and milk</i> in Class 29 and <i>bread, pastry</i> in Class 30</p>	<p>A limitation can be introduced for both PGIs. The public will not be deceived as to the geographical origin of the products.</p> <p>Class 29: '<a href="#">Sobrasada de Mallorca</a>' (GI) <i>sausage</i> ; <i>eggs</i>; <i>milk</i> .</p> <p>Class 30: <i>bread</i>, '<a href="#">Ensaïmada de Mallorca / Ensaïmada mallorquina</a>' (GI) <i>pastry</i>.</p>

GI	EUTM	Explanation
<p><a href="#">Champagne</a> (PDO-FR-A1359) for <i>wine</i></p> <p><a href="#">Ratafia champenois</a>(PGI-F R-02062) for <i>liqueur</i></p> <p><a href="#">Marc de Champagne / Eau-de-vie de marc de Champagne</a>(PGI-F R-02063) for <i>grape marc spirit</i></p>	<p><b>AXM CHAMPAGNE</b> (invented) for <i>alcoholic beverages</i> in Class 33</p>	<p>The application can be accepted if a limitation is introduced for one or several GIs. Depending on the outcome of such limitation, the other goods will be assessed under <a href="#">Article 7(1)(g) EUTMR</a> .</p> <p>Even if the spirit drinks protected by the various GIs concerned are comparable among themselves, a limitation is acceptable for each of them, as the application includes the common term 'Champagne' or 'champenois' (from Champagne) protected for various types of spirit drinks.</p> <p>For example, Class 33: '<a href="#">Champagne</a>' (GI) <i>wine</i>; '<a href="#">Ratafia champenois</a>' (GI) <i>liqueur</i>; '<a href="#">Marc de Champagne / Eau-de-vie de marc de Champagne</a>' (GI) <i>grape marc spirit</i>.</p> <p>If the EUTM application includes in full a different GI with the term 'Champagne' (e.g. AXM MARC DE CHAMPAGNE), it can be accepted if the goods are properly limited (only to this GI).</p> <p>For example, Class 33: '<a href="#">Marc de Champagne / Eau-de-vie de marc de Champagne</a>' (GI) <i>grape marc spirit</i> .</p>

GI	EUTM	Explanation
<p><a href="#">Prosciutto di Modena</a> (PDO-IT-0066) for <i>ham</i></p> <p><a href="#">Zampone Modena</a> (PGI-IT-1501) for <i>sausage</i></p> <p><a href="#">Cotechino Modena</a> (PGI-IT-1500) for <i>sausage</i></p>	<p><b>AXM MODENA</b> (invented) for <i>meat</i> in Class 29</p>	<p>The application can be accepted if a limitation is introduced for one or various GIs and the deceptive goods are deleted.</p> <p>For example, '<a href="#">Prosciutto di Modena</a>' (GI) <i>ham</i>; '<a href="#">Zampone Modena</a>' (GI) <i>sausage</i>; '<a href="#">Cotechino Modena</a>' (GI) <i>sausage</i> . The rest of the <i>meat</i> products are deleted.</p> <p>Even if the products concerned, protected by various GIs, are comparable, a limitation can be introduced in relation to all of them, as the application includes the common term 'MODENA', which is protected for various types of meat products.</p> <p>A limitation such as '<a href="#">Prosciutto di Modena</a>' (GI) <i>meat</i> is not acceptable.</p>



GI	EUTM	Explanation
<p><a href="#">Orujo de Galicia</a> (PGI-ES-01914) for <i>grape marc spirit</i> or <i>grape marc</i></p> <p><a href="#">Licor café de Galicia</a> (PGI-ES-01911) for <i>liqueur</i></p> <p><a href="#">Licor de hierbas de Galicia</a> (PGI-ES-01912) for <i>liqueur</i></p> <p><a href="#">Aguardiente de hierbas de Galicia</a> (PGI-ES-01913) for <i>other spirit drinks</i> (<i>grape marc spirit</i>)</p>	<p><b>AXM GALICIA</b>  (invented) for <i>alcoholic</i> <i>beverages</i> in Class 33</p>	<p>All spirits are comparable. The application can be accepted if a limitation is introduced for one or various GIs and the deceptive goods are deleted (i.e. all other spirit drinks; however, <i>wines</i> are acceptable).</p> <p>For example, Class 33: '<a href="#">Orujo de Galicia</a>' (GI) <i>grape marc spirit</i> or <i>grape marc</i>; '<a href="#">Licor café de Galicia</a>' (GI) <i>liqueur</i>; '<a href="#">Licor de hierbas de Galicia</a>' (GI) <i>liqueur</i>; '<a href="#">Aguardiente de hierbas de Galicia</a>' (GI) <i>grape marc spirit</i>; <i>wines</i> .</p> <p>If the EUTM application fully includes one of the GIs with the term 'Galicia' (e.g. AXM ORUJO DE GALICIA), it can be accepted if the goods are properly limited.</p> <p>For example, Class 33: '<a href="#">Orujo de Galicia</a>' (GI) <i>grape marc spirit</i> or <i>grape marc</i> .</p>

## 5 Relevant Goods under EU Regulations

Objections based on [Article 7\(1\)\(j\) EUTMR](#) can be raised **only** for specific goods of the EUTM application, namely those that are identical or 'comparable' to ones covered by the GI. The Office does not raise objections *ex officio* against different goods.

### 5.1 Identical products

Identifying the specific products that are covered by a GI can be a complex exercise.

The products covered by a GI protected under [Regulation \(EU\) No 1308/2013](#) are all for *wine*.

Regarding GIs for *spirit drinks* , protected under [Regulation \(EU\) 2019/787](#) , the category of products covered corresponds to one of the categories in Annex I of that Regulation (e.g. *rum*, *whisky*, *grain spirit*, *wine spirit* , etc.). They are further specified in the product category that appears in the [eAmbrosia](#) register. For instance, '[Samané](#)' is protected for *grain spirit* , '[Eau-de-vie de Cognac / Eau-de-vie des Charentes / Cognac](#)' for *wine spirit* and '[Scotch Whisky](#)' for *whisky*.

The products covered by a GI protected under [Regulation \(EU\) No 1151/2012](#) mostly refer to *foodstuffs and beverages* in Classes 29, 30, 31 and 32. However, there are a number of exceptions. For example:

- Class 3: *essential oils* (e.g. PDO '[Bergamotto di Reggio Calabria -Olio essenziale](#)');
- Class 22: *wool* (e.g. PDO '[Native Shetland Wool](#)');
- Class 31: *flowers and ornamental plants* (e.g. PGI '[Vlaamse laurier](#)') or *hay* (e.g. PDO '[Foin de Crau](#)').

Importantly, the product covered by the GI is the one specified in the description of the product in the Official Journal publication containing the application for registration. The [Giview](#) database includes a link to this publication (C series). This product should not be confused with the general product class.

For instance, the PGI '[Welsh Beef](#)' only covers 'beef' but is classified under 'Class 1.1. Fresh meat (and offal)'. Similarly, the PDO '[Pomme du Limousin](#)' only covers 'apples' but is classified under 'Class 1.6. Fruit, vegetables and cereals fresh or processed'. Whether products other than 'beef' or 'apples' are acceptable for registration is a different assessment (see [paragraph 5.2](#) ).

The applicant may overcome the objection by restricting the list of goods. This is further explained in [paragraph 5.3](#) .

Apart from the exact products that a GI refers to, the Office will raise an objection to any other goods in which the GI product can be seen as the **commercially relevant ingredient** .

Finally, the Office will raise an objection when identical goods constitute the *specific object of services* such as *retail, wholesale, import/export, provision of drink and food, production of [the product covered by the GI] for others* . Any objection and subsequent limitation of the goods will be duly reflected in the services for which protection is sought, should the EUTM refer to those same goods as part of its specification of services.

For example, if an EUTM refers in its elements to the PDO '[Slavonski med](#)' ('med'='honey') and seeks protection for goods in Class 30 — *honey* and also for services in Class 35 — *retail services relating to honey* , the objection and subsequent limitation to '[Slavonski med](#)' (GI) *honey* will have to be reflected in both Classes 30 and 35.

## 5.2 Comparable products

GIs are protected not only as regards trade marks applied for in respect of identical products to the product covered by the GIs but also, under certain circumstances, as regards those applied for in respect of **comparable products**.

Importantly, **while GI protection against comparable goods is automatic in situations of direct or indirect use of GIs, there is no such automatic protection in cases of evocation**. As explained in [paragraph 4.2](#), consumers must also **establish a link** between the term used to designate the product (i.e. the trade mark) and the

product whose designation is protected. In establishing the link, the **degree of proximity of the products** is one of the factors to be taken into account. As a consequence, it is necessary to assess, given all the relevant factors, whether a link will be established in the mind of the relevant public. See [paragraph 4.2](#) for more details.

The EU GI regulations contain references to **different expressions**, all interpreted by the Office as synonyms of comparable goods.

Specifically for *wines*, the different terms used in Articles [102\(1\)](#) and [103\(2\)](#) of Regulation (EU) No 1308/2013 ('product falling under one of the categories listed in Part II of Annex VII' and 'comparable products', respectively) are interpreted by the Office as synonyms referring to the same concept. For ease of reference, the categories listed in Part II of Annex VII can be grouped into: (i) *wine*; (ii) *sparkling wine*; (iii) *grape must*; (iv) *wine vinegar*.

For *spirit drinks*, [Regulation \(EU\) 2019/787](#) does not specify anything in this regard.

For *agricultural products and foodstuffs*, the different terms used in Articles [13](#) and [14](#) of Regulation (EU) No 1151/2012 ('comparable' products, and products 'of the same type' respectively) are interpreted by the Office as synonyms referring to the same concept.

The notion of **comparable goods must be understood restrictively and is independent of the analysis of similarity between goods in trade mark law**. Accordingly, the criteria set out in the judgment of 29/09/1998, [C-39/97](#), Canon, EU:C:1998:442, should not necessarily be adhered to, although some of them may be useful. For example, given that a GI serves to indicate the geographical origin and the particular qualities of a product, criteria such as the nature of the product or its composition are more relevant than, for instance, whether or not goods are complementary.

In particular, the CJEU (14/07/2011, [C-4/10](#) & [C-27/10](#), BNI Cognac, EU:C:2011:484, § 54) has developed certain criteria for determining whether goods are comparable, specifically whether **the products have common objective characteristics, such as method of elaboration, the physical appearance of the product or use of the same raw materials**.

In addition, factors such as whether the products are consumed, from the point of view of the relevant public, on **largely identical occasions**, or whether they are **distributed** through the same channels and/or subject to similar marketing rules, can be taken into account in order to **confirm** whether goods are comparable.

Although it is not possible in these Guidelines to list all the possible scenarios, the following are some examples of comparable products.

Products covered by the PDO/PGI	Comparable products
---------------------------------	---------------------

<p><i>Wine</i></p>	<p>All types of <i>wines</i> (including <i>sparkling wine</i>); <i>grape must</i>; <i>aromatised wines</i>.</p> <p>See Part II of <a href="#">Annex VII Regulation (EU) No 1308/2013</a>.</p> <p><i>Wine vinegar</i>; <i>wine-based beverages</i> (e.g. <i>sangría</i>) are not ‘comparable products’, but the wine covered by the GI can be a commercially relevant ingredient; see below under ‘Products used as ingredients’.</p>
<p><i>Aromatised wines</i></p>	<p>All types of <i>wines</i>; <i>aromatised wines</i> (e.g. <i>vermouth</i>).</p> <p><i>Aromatised wine-based drinks</i> (e.g. <i>sangría</i>); and <i>aromatised wine-product cocktails</i> (e.g. <i>sparkling wine cocktail</i>) are not ‘comparable products’, but the wine covered by the GI can be a commercially relevant ingredient; see below under ‘Products used as ingredients’.</p>
<p><i>Spirits</i></p>	<p>All types of <i>spirits</i>.</p> <p><i>Spirit-based drinks</i> are not ‘comparable products’, but the spirit drink covered by the GI can be a commercially relevant ingredient; see below under ‘Products used as ingredients’.</p>
<p><i>Fresh fruit</i></p>	<p><i>Preserved, frozen, dried and cooked fruits</i> (<i>jellies, jams, compotes</i>) are not ‘comparable products’, but the fruit covered by the GI can be a commercially relevant ingredient; see below under ‘Products used as ingredients’.</p>
<p><i>Fresh vegetables</i></p>	<p><i>Preserved, frozen, dried and cooked vegetables</i> (<i>jellies, jams</i>) are not ‘comparable products’, but the vegetable covered by the GI can be a commercially relevant ingredient; see below under ‘Products used as ingredients’.</p>

Depending on the specific goods, the applicant may overcome an objection against comparable goods by restricting the list of goods.

### 5.3 Restriction of the list of goods

According to [Article 103\(1\) of Regulation \(EU\) No 1308/2013](#), GIs may be used by any operator marketing a wine conforming to the corresponding specification.

According to [Article 12\(1\) of Regulation \(EU\) No 1151/2012](#), ‘protected designations of origin and protected geographical indications may be used by any operator marketing a [agricultural or foodstuff] product conforming to the corresponding specification’.

Objections raised under [Article 7\(1\)\(j\) EUTMR](#) may be waived if the relevant goods are restricted to comply with the specifications of the GI in question.

Restricting goods can be a complex task, which may depend to a large extent on a case-by-case examination.

- **Products identical** to those covered by the GI must be restricted to that particular GI, by referring to its name, to show the applicant’s recognition of the need to comply with the specifications of that particular GI. The wording recommended by the Office is ‘[GI name]’ (GI) [product covered by the GI]. Other limitations are, however, acceptable as long as the applicant clearly identifies the GI and the use thereof.

GI in the EUTM	Acceptable list of goods
<a href="#">Slovácká</a> (PDO-CZ-A0890)	<i>'Slovácká' (GI) wine</i>
<a href="#">WELSH BEEF</a> (PGI-GB-0057)	<i>'Welsh Beef' (GI) beef meat</i>
<a href="#">TEQUILA</a>	<i>'Tequila' (GI) agave spirit drinks</i>

The category of products that includes those covered by the GI should be restricted as follows:

- For wines, the restriction should designate wines that comply with the specifications of the GI;
- For spirit drinks, the restriction should designate the exact category of product (e.g. whisky, rum, fruit spirit, in accordance with [Annex I of Regulation \(EU\) No 2019/787](#) ) that complies with the specifications of the GI. This information can be found in the [Glview](#) database;
- For agricultural products and foodstuffs, the category of products that includes those covered by the GI should be restricted to designate exactly the products covered by the GI and complying with its specifications. The category of products that includes those covered by the GI in question can be consulted in the [Glview](#) database. The exact product covered can be found in the application document attached to the publication in the Official Journal (C series), also accessible through [Glview](#).

GI in the EUTM	Original specification (not acceptable)	Acceptable list of goods	Explanation
<a href="#">TOKAJ / TOKAJI</a> (PDO-HU-A1254)	<i>Wines</i>	<i>'Tokaj / Tokaji' (GI) wine</i>	The EUTM can be accepted only for <i>wine</i> covered by the PDO.
<a href="#">WELSH BEEF</a> (PGI-GB-0057)	<i>Meat</i>	<i>'Welsh Beef' (GI) beef meat</i>	' <i>Meat</i> ' includes products (e.g. pork) that cannot comply with the specifications of a particular PGI that covers the specific product <i>beef meat</i> .
<a href="#">POMME DU LIMOUSIN</a> (PDO-FR-0442)	<i>Fruits</i>	<i>'Pomme du Limousin' (GI) apples</i>	The category <i>fruits</i> includes products such as <i>pears</i> or <i>peaches</i> , which cannot meet the specifications of a PDO that exclusively covers <i>apples</i> .

- **Comparable products:** An objection **must be raised** for comparable goods when they cannot be part of the restriction, for example when the goods applied for, although 'comparable', do not include the product covered by the GI;

GI in the EUTM	Original specification (not acceptable)	Acceptable list of goods	Explanation
----------------	--	--------------------------	-------------

<p><a href="#">MOSLAVINA</a> (PDO-HR-A1653) for <i>wine</i></p>	<p><i>Alcoholic beverages</i> (except <i>beers</i> )</p>	<p>e.g. <i>wine and beverages based on 'Moslavina' (GI) wine; spirits, rum</i> (examples)  e.g. <i>alcoholic beverages (except beers) other than wines and beverages based on or containing wine.</i></p>	<p>The EUTM can be accepted for <i>wine</i> complying with the specifications of the PDO, and for <i>beverages based on or containing wine</i> complying with the specifications of the PDO.  Alternatively, <i>alcoholic beverages other than wines, and wine-based beverages</i> are acceptable to the extent that they are not deceptive.</p>
<p><a href="#">RIOJA</a> (PDO-ES-A0117) for <i>wine</i></p>	<p><i>Wine, spirits</i></p>	<p><i>'Rioja' (GI) wine, spirits</i></p>	<p>The EUTM can be accepted for <i>wine</i> complying with the specifications of the PDO.  The EUTM can, in principle, be accepted under <a href="#">Article 7(1)(j) EUTMR</a> for <i>spirits</i> as they are not considered comparable to <i>wine</i>.</p>

<p><b><u>POMME DU LIMOUSIN</u></b> (PDO-FR-0442) for <i>apples</i></p>	<p><i>Preserved, frozen, dried and cooked fruits</i></p>	<p><i>'<u>Pomme du Limousin</u>' (GI) preserved, frozen, dried and cooked apples</i></p>	<p><i>Preserved, frozen, dried and cooked fruits</i> include products made of other fruits, which cannot meet the specifications of a PDO that exclusively covers <i>apples</i>.</p> <p>Note also that the limitation should be not only for <i>apples</i>, but also for <i>processed apples</i>. The EUTM can, in principle, be accepted under <a href="#">Article 7(1)(j) EUTMR</a> for other specific frozen fruits to the extent that they are not deceptive.</p>
<p><b><u>BRANDY DE JEREZ</u></b> (PGI-ES-01944) for <i>brandy or weinbrand</i></p>	<p><i>Spirits; brandy; whisky</i></p>	<p><i>'<u>Brandy de Jerez</u>' (GI) brandy</i></p>	<p><i>Whisky</i> is a category of spirit drinks that is considered comparable to <i>brandy</i>.</p> <p>At the same time, <i>whisky</i> cannot meet the specifications set for <i>brandy</i>.</p> <p>As a result, the category of <i>spirits</i> must be narrowed down to the product protected by the GI '<u>Brandy de Jerez</u>', namely to <i>brandy</i>. The EUTM application must be refused for <i>whisky</i>, as being comparable to <i>brandy</i>, and for the general category of <i>spirits</i>, as all <i>spirits</i> are considered comparable.</p>



<p><b><u>SCOTCH WHISKY</u></b> (PGI-GB-01854) for <i>whisky</i></p>	<p><i>Whisky; alcoholic beverages</i></p>	<p><i>'Scotch Whisky' (GI) whisky</i></p>	<p>The EUTM can be accepted for <i>whisky</i> complying with the specifications of the GI.</p> <p>Contrary to the situation for GIs for <i>wines</i>, the limitation cannot be extended to <i>alcoholic beverages other than whisky</i> as it may include alcoholic beverages comparable to <i>whisky</i>. It is up to the applicant to specifically list the non-deceptive and non-comparable spirit drinks.</p>
---	---	---	---

- **Products used as ingredients:** if the goods covered by the GI can be used as a commercially relevant ingredient (in the sense that it may determine the choice of the main product) of any of the goods included in the EUTM application, a restriction will be requested. This is because [Article 13\(1\)\(a\) and \(b\) of Regulation \(EU\) No 1151/2012](#) expressly extends the scope of protection of a GI registered for a given product 'when those products are used as an ingredient';

GI in the EUTM	Original specification (which is not acceptable)	Acceptable list of goods	Explanation
<p><b><u>POMME DU LIMOUSIN</u></b> (PDO-FR-0442) for <i>apples</i></p>	<p><i>Jams and compotes</i></p>	<p><i>Jams and compotes of 'Pomme du Limousin' (GI) apples</i></p>	<p>Fruit is the main ingredient of <i>jams and compotes</i>.</p>
<p><b><u>PROSCIUTTO DI PARMA</u></b> (PDO-IT-0067) for <i>ham</i></p>	<p><i>Pizzas</i></p>	<p><i>Pizzas with 'Prosciutto di Parma' (GI) ham</i></p>	<p>This topping is the main ingredient of a <i>pizza</i> and the one that determines the consumer's choice.</p>

GI in the EUTM	Original specification (which is not acceptable)	Acceptable list of goods	Explanation
<p><a href="#">RIOJA</a> (PDO-ES-A0117) for <i>wine</i></p>	<p><i>Wine vinegar</i></p>	<p><i>Wine vinegar made from 'Rioja' (GI) wine</i></p>	<p>The EUTM can be accepted for <i>wine vinegar</i> complying with the specifications of the PDO. Wine is an ingredient of <i>vinegar</i> (wine vinegar is made of wine).</p>
<p><a href="#">TURRÓN DE AGRAMUNT / TORRÓ D'AGRAMUNT</a> (PGI-ES-0167) for <i>nougat</i></p>	<p><i>Ices</i></p>	<p><i>'Turrón de Agramunt / Torró d'Agramunt' (GI) nougat-based edible ices</i></p>	<p>Nougat is a commercially relevant ingredient for ice cream.</p>
<p><a href="#">BERGAMOTTO DI REGGIO CALABRIA – OLIO ESSENZIALE</a> (PDO-IT-0105) for <i>essential oil</i></p>	<p><i>Perfumes</i></p>	<p><i>Perfumes with 'Bergamotto di Reggio Calabria – Olio essenziale' (GI) essential oil</i></p>	<p>Bergamot is an essential oil that provides a particular aroma to perfume. This aroma is what drives the consumers' choice and is thus the commercially relevant ingredient.</p>
<p><a href="#">SCOTCH WHISKY</a> (PGI-GB-01854) for <i>whisky</i></p>	<p><i>Cocktails</i></p>	<p><i>'Scotch Whisky' (GI) whisky-based cocktails</i></p>	<p>The EUTM can be accepted for cocktails made of whisky complying with the specifications of the GI.  Contrary to wines, <i>cocktails, other than whisky-based</i> are not acceptable to the extent that they may be deceptive.</p>

A restriction is not necessary if the goods covered by the GI are used as a secondary, not commercially relevant, ingredient of the claimed goods.

GI in the EUTM	Original specification	Acceptable list of goods	Explanation
<a href="#">ACEITE DE LA ALCARRIA</a> (PDO-ES-0562) for <i>olive oil</i>	<i>Pastry</i>	<i>Pastry</i>	The goods do not need to be restricted by the mere fact that <i>oil</i> is used in their preparation. <i>Oil</i> is a secondary ingredient that is not commercially relevant.

## 6 GIs not Protected under EU Regulations

### 6.1 GIs protected at national level in an EU Member State

The Court of Justice has stated (08/09/2009, [C-478/07](#), Budějovický Budvar, EU:C:2009:521) that the EU system of protection for GIs for *agricultural products and foodstuffs* laid down in [Regulation \(EC\) No 510/2006](#) [then in effect] is ‘**exhaustive in nature**’. The Court further confirmed that the same must be true for the EU system of protection for GIs for *wines* as laid down in [Regulation \(EC\) No 1234/2007](#) [then in effect], as these ‘two systems were, essentially, the same in nature, since their objectives and characteristics were similar’ (14/09/2017, [C-56/16 P](#), PORT CHARLOTTE, EU:C:2017:693, § 76). For *agricultural products and foodstuffs*, see [Article 9 of Regulation \(EU\) No 1151/2012](#) read in conjunction with [recital 24 of that Regulation](#). For *wines* see [Article 107 of Regulation \(EU\) No 1308/2013](#).

The Office applies an analogous approach for GIs for *spirit drinks* for the following reasons. The former protection at national level of GIs for *spirit drinks* that now qualify for a GI under [Regulation \(EU\) 2019/787](#) was **discontinued** once those GIs were registered at EU level (see [Article 37 of Regulation \(EU\) No 2019/787](#), read in conjunction with Articles [15\(2\)](#) and [20\(1\)](#) of Regulation (EC) No 110/2008).

Moreover, reference must also be made to [Council Regulation \(EEC\) No 2081/92](#) on the protection of geographical indications and designations of origin for *agricultural products and foodstuffs*. That regulation (which preceded and was repealed by [Regulation \(EC\) No 510/2006](#)) set out in Article 17(1) that Member States had to ‘inform the Commission which of their legally protected names ... they wish[ed] to register’ pursuant to that Regulation. Paragraph 3 added that Member States could ‘maintain national protection of the names communicated in accordance with paragraph 1 until such time as a decision on registration has been taken’ (04/03/1999, [C-87/97](#), Cambozola, EU:C:1999:115, § 18).

In other words, the EU system of protection comprising the above EU regulations **overrides and replaces** national protection of GIs for *agricultural products and foodstuffs, wines and spirit drinks*.

In light of the foregoing, *wines, spirits and agricultural products and foodstuffs* that now qualify for a GI under EU regulations and in the past enjoyed protection by means of national legislation do not fall within the scope of [Article 7\(1\)\(j\) EUTMR](#). Accordingly, they do not constitute, as such, and for that reason alone, a ground for refusal under [Article 7\(1\)\(j\) EUTMR](#), unless they have **also been registered at EU level**. Therefore, if, for example, a third party argues that an EUTM application contains or consists of a geographical indication for *wines* that was registered in the past at national level in an EU Member State, the examiner will check whether the geographical indication is also registered at EU level as a GI. If not, the third-party observations will be deemed not to raise serious doubts as regards [Article 7\(1\)\(j\) EUTMR](#).

However, in those areas where no uniform EU system of protection is in place, GIs protected under national law fall within the scope of [Article 7\(1\)\(j\) EUTMR](#). This is the case, in particular, for GIs for *craft and industrial products*.

Currently, neither the Commission nor the Office keeps a database listing the GIs protected under national law for *craft and industrial products*. Given the inherent difficulty in identifying such GIs, the Office will in these cases rely principally on observations by third parties.

## 6.2 GIs from non-EU countries

The following situations refer to GIs from non-EU countries that are not simultaneously registered at EU level. If a non-EU GI is registered at EU level, [paragraphs 4](#) and [5](#) of this section of the Guidelines apply (e.g. '[Café de Colombia](#)', '[Ron de Guatemala](#)').

### 6.2.1 GI is protected only in the non-EU country of origin under its national legislation

[Article 7\(1\)\(j\) EUTMR](#) does not apply since the non-EU GI is not recognised and protected *expressis verbis* under EU legislation. In this respect, note that the provisions of the TRIPs Agreement are not such as to create rights upon which individuals may rely directly before the courts by virtue of EU law (14/12/2000, [C-300/98](#) & [C-392/98](#), Dior and Others, EU:C:2000:688, § 44).

Example: 'Miel Blanc d'Oku' from Cameroon.

For non-EU GIs protected in a Member State by virtue of an international agreement signed by that Member State (and not the EU), see below for more details.

Nevertheless, when the EUTM application contains or consists of one such protected GI, it must also be assessed whether the EUTM may be considered descriptive and/or deceptive under [Article 7\(1\)\(c\) and \(g\) EUTMR](#) in accordance with the general rules set out in these Guidelines. For example, where a third party observes that an EUTM application consists of the term 'Murakami' (invented example), which is a GI for *spirits*

in accordance with the national legislation of country X, [Article 7\(1\)\(j\) EUTMR](#) will not apply for the reasons set out above, but it must be examined whether or not the EUTM will be perceived as a descriptive and/or deceptive sign by the relevant EU consumers.

### 6.2.2 GI is protected under an agreement to which the EU is a contracting party

The EU has signed a number of trade agreements with non-EU countries to protect GIs. These instruments typically include a list of the GIs, as well as provisions on their conflicts with trade marks. The content and degree of precision may nevertheless vary from one agreement to another. GIs from non-EU countries are protected at EU level after the relevant agreement has entered into force.

In this respect, it is settled case-law that a provision of an agreement entered into by the EU with non-EU countries must be regarded as being directly applicable when, in view of the wording, purpose and nature of the agreement, it may be concluded that the provision contains a **clear, precise and unconditional obligation that is not subject, in its implementation or effects, to the adoption of any subsequent measure** (14/12/2000, [C-300/98](#) & [C-392/98](#), Dior and Others, EU:C:2000:688, § 42).

The scope of protection given to these GIs by non-EU countries is defined through the substantive provisions of the agreement concerned, which may, for instance, include specific requirements or authorisation for use of the protected term. While the oldest agreements usually contained only general provisions, the 'latest generation' of free-trade agreements refer to the relationship between trade marks and GIs in similar terms to Articles [102](#) and [103](#) of Regulation (EU) No 1308/2013 (see, for example, Articles 210 and 211 of the 'Trade Agreement between the European Union and its Member States, of the one part, and Colombia and Peru, of the other part', OJ L 354, 21/12/2012).

In the light of this, EUTMs that contain or consist of a non-EU GI that is protected by an agreement to which the EU is a contracting party (and that is not simultaneously registered under the EU regulations) are examined on a case-by-case basis in accordance with the specific substantive provisions of the agreement in question on the refusal of conflicting trade marks, taking into account the case-law cited above.

Nevertheless, the mere fact that a GI from a non-EU country is protected by those instruments **does not automatically** imply that an EUTM that evokes or even contains or consists of the GI must be refused: this will depend on the **content and scope** of the agreement's relevant provisions.

Apart from applying [Article 7\(1\)\(j\) EUTMR](#) to the extent provided under each of the agreements, if, in the course of the proceedings and in particular in light of third-party observations, it becomes evident that the trade mark would deceive the public, for example as regards its origin or the right to use the GI, the Office will also consider raising an objection based on [Article 7\(1\)\(g\) EUTMR](#).

As regards the **relevant point in time** for the protection of such GIs, a case-by-case approach is necessary. GIs included in the initial agreement are normally protected as

of the date when the agreement enters into force. However, the list of protected GIs can subsequently be updated in the ‘second-generation agreements’. In these cases, the relevant priority date varies from agreement to agreement: in some cases, the priority date may be the date of the request by the non-EU country to update the list and not the date when the Commission accepts the inclusion of the GIs.

The [Glview](#) database displays information obtained directly from the European Commission on, inter alia, third-country GIs protected at EU level through bilateral and multilateral agreements.

The trade agreements signed by the EU with non-EU countries typically have annexed to them a list of the GIs registered at EU level that are also to be protected in the non-EU countries in question (11/05/2010, [T-237/08](#), Cuvée Palomar, EU:T:2010:185, § 104-108; 19/06/2013, [R 1546/2011-4](#), FONT DE LA FIGUERA).

- Examples:

GI	Country of origin	Products
<a href="#">Aguardiente chileno</a>	Chile	<i>Spirit drinks</i>
<a href="#">Rooibos / Red Bush / Rooibostee / Rooibos tea / Rooitee / Rooibosch</a>	South Africa	<i>Infusion</i>
<a href="#">Breede River Valley</a>	South Africa	<i>Wine</i>
<a href="#">Abricotine / Eau-de-vie d’abricot du Valais</a>	Switzerland	<i>Fruit spirit</i>

### 6.2.3 GI is protected under the Lisbon System (Geneva Act)

The EU became a contracting party to the Geneva Act of the Lisbon Agreement on Appellations of Origin and Geographical Indications (the ‘Geneva Act’) pursuant to [Council Decision \(EU\) 2019/1754](#)<sup>(28)</sup>. As from the date of entry into force of the Geneva Act (26 February 2020), GIs from non-EU countries protected under the Lisbon System will form the basis for objections pursuant to [Article 7\(1\)\(j\) EUTMR](#).

In order to lay down the rules allowing the EU to exercise the rights and to fulfill the obligations laid down in the Geneva Act, the European Parliament and the Council adopted [Regulation \(EU\) 2019/1753](#) on the action of the Union following its accession to the Geneva Act of the Lisbon Agreement on Appellations of Origin and Geographical Indications ([Regulation \(EU\) 2019/1753](#))<sup>(29)</sup>.

<sup>28</sup> [Council Decision \(EU\) 2019/1754](#) of 7 October 2019 on the accession of the European Union to the Geneva Act of the Lisbon Agreement on Appellations of Origin and Geographical Indications.

<sup>29</sup> [Regulation \(EU\) 2019/1753](#) of the European Parliament and of the Council of 23 October 2019 on the action of the Union following its accession to the Geneva Act of the Lisbon Agreement on Appellations of Origin and Geographical Indications.

### Relevant GIs under the Lisbon System<sup>30</sup>

[Article 7\(1\)\(j\) EUTMR](#) in combination with [Regulation \(EU\) 2019/1753](#) applies to GIs:

- originating from a non-EU country;
- that refer to products protected at European Union level (i.e. *wines, spirit drinks and agricultural products and foodstuffs*);
- that have been registered in the International Register; and
- that have been granted protection in the European Union through [Regulation \(EU\) 2019/1753](#).

### Relevant point in time

Applications for international registration of GIs are filed with the International Bureau of WIPO. The International Bureau publishes the international registration in the WIPO Bulletin and **notifies it to the Commission** (Articles 5 and 6 of the Geneva Act). The Commission then publishes it in the Official Journal of the European Union ([Article 4 of Regulation \(EU\) 2019/1753](#)) and assesses it ([Article 5 of Regulation \(EU\) 2019/1753](#)).

The GI application can be opposed by third parties within 4 months from the date of its publication in the Official Journal of the European Union ([Article 6 of Regulation \(EU\) 2019/1753](#)). The procedure ends with a decision of the Commission on the protection in the EU of the third-country GI ([Article 7 of Regulation \(EU\) 2019/1753](#)).

In principle, the relevant dates for establishing which right is the earliest are the filing date of the EUTM application (or its priority date under the Paris Convention, if claimed) and the date on which the application for the international registration of the GI was received by the International Bureau. However, [Article 10\(3\) of Regulation \(EU\) 2019/1753](#) allows for the **coexistence** of a protected GI and a trade mark that has been applied for or registered in good faith within the European Union **before the date on which the International Bureau notified the Commission** of the international registration of the GI.

In other words, a trade mark application filed in **good faith** after the date when the application for international registration was received by the International Bureau (GI application) but before notification of the publication of the registration to the Commission (notification to the Commission) is not objectionable as the trade mark can coexist with the GI. In the absence of any evidence or indication to the contrary (e.g. via third-party observations or in *inter partes* proceedings), the Office will assume good faith on the part of the trade mark applicant/proprietor.

As a result:

- in *ex officio* examination, **unless there are indications of lack of good faith** (e.g. through third-party observations), the relevant date is **the date of notification of the international registration to the Commission**, and the Office will **object only** to the registration of trade marks **filed after that date**;
- an **opposition** against a trade mark filed after the GI application to the International Bureau but before notification of the international registration to the Commission can

---

<sup>30</sup> WIPO currently administers a database including information on all the GIs protected under the Lisbon system: Lisbon Express, available at: <https://www.wipo.int/ipdl/en/search/lisbon/search-struct.jsp>.



only be successful if lack of good faith in filing the trade mark application is proven by the opponent;

- in **cancellation proceedings**, registered trade marks applied for after the GI application to the International Bureau but before notification to the Commission cannot be invalidated unless the invalidity applicant proves lack of good faith at the time of filing of the trade mark.

Objections can be based on GIs already notified to the Commission but for which the Commission has not taken a decision on protection. If the EUTM applicant does not submit observations or does not overcome the objection, the Office will suspend the examination proceedings until the Commission has taken a decision or 1 year has elapsed without a refusal since receipt from the International Bureau of notification of the international registration ([Article 7\(4\) Regulation \(EU\) 2019/1753](#)).

#### Scope of protection of GIs under the Geneva Act

Under Article 11(1) of the Geneva Act, protection exists against:

1. use of the appellation of origin or the geographical indication:
  - a. in respect of goods of the same kind as those to which the appellation of origin or the geographical indication applies, not originating in the geographical area of origin or not complying with any other applicable requirements for using the appellation of origin or the geographical indication;
  - b. in respect of goods that are not of the same kind as those to which the appellation of origin or geographical indication applies or services, if such use would indicate or suggest a connection between those goods or services and the beneficiaries of the appellation of origin or the geographical indication, and would be likely to damage their interests, or, where applicable, because of the reputation of the appellation of origin or geographical indication in the Contracting Party concerned, such use would be likely to impair or dilute in an unfair manner, or take unfair advantage of that reputation;
2. any other practice liable to mislead consumers as to the true origin, provenance or nature of the goods.

According to Article 11(3) of the Geneva Act, a Contracting Party must, *ex officio* if its legislation so permits, or at the request of an interested party, refuse or invalidate the registration of a later trade mark if use of the trade mark would result in one of the situations covered by paragraph (1).

Consequently, the legal provisions on which the Office will base its objections will be those of Article 11(1) and (3) of the Geneva Act in conjunction with [Regulation \(EU\) 2019/1753](#).

The Office considers that although Article 11(1) of the Geneva Act is worded differently from the respective articles of the four EU Regulations relating to protection of GIs, the substantive protection granted to GIs under the Geneva Act is the same: that is to say, those GIs are protected against **direct and indirect use** of the GI for the same or comparable products (see [paragraph 4.1](#) above), direct or indirect use that would **exploit the reputation** of the GI (see [paragraph 4.1.1](#) above), any **misuse, imitation**



**or evocation** (see [paragraph 4.2](#) above), and any other **misleading indications and practices** (see [paragraph 4.3](#) above).

The Office will therefore apply the same standard to GIs protected under the Geneva Act and will examine potential conflict with earlier GIs, bearing in mind, *mutatis mutandis*, the rules contained above in [paragraph 4 Situations Covered by the EU Regulations and Absolute Grounds Examination](#). In addition, the Office considers that the notion of ‘goods that are not of the same kind’ is analogous to the notion of ‘non-comparable goods’ under the EU Regulations providing for the protection of GIs. See [paragraph 5.2](#) above.

In practice, this means that in *ex officio* examination, Article 11(1)(a)(i) of the Geneva Act will be invoked and will apply in situations corresponding to ‘use’ of the GI for the same and comparable products; Article 11(1)(b), which provides for protection against ‘any other practice liable to mislead consumers as to the true origin, provenance or nature of the goods’, will be invoked in all the other situations provided for in the EU Regulations: that is to say misuse, imitation, evocation and other misleading indications and practices.

On the other hand, the Office will not invoke, in *ex officio* examination, Article 11(1)(a)(ii) of the Geneva Act, which refers to the use of GIs in respect of goods or services that are not of the same kind as those to which the appellation of origin or geographical indication applies (i.e. non-comparable goods and services). The Office cannot take an *ex officio* decision regarding situations described in that article in the absence of arguments and evidence from the beneficiary of the GI. Article 11(1)(a)(ii) of the Geneva Act can, however, be relied on in third-party observations and in oppositions pursuant to Article 8(6) EUTMR (see [the Guidelines, Part C, Opposition, Section 6, Geographical indications \(Article 8\(6\) EUTMR\)](#)).

6.2.4 GI is protected under an international agreement signed only by Member States (i.e. the EU is not a party)

[Article 7\(1\)\(j\) EUTMR](#) applies to GIs protected by international agreements to which a Member State is a party. However, by analogy with the Office’s interpretation of [Article 7\(1\)\(j\) EUTMR](#) as far as national law is concerned, the Office considers that the reference to ‘international agreements to which the ... Member State concerned is party’ should be interpreted as international agreements in those areas where no uniform EU protection is in place, namely *craft and industrial products* (see [paragraph 5.1](#) above).

In its judgment of 08/09/2009, [C-478/07](#), Budějovický Budvar, EU:C:2009:521, the Court discussed the exhaustive nature of EU law as regards GIs originating from Member States. In the Office’s interpretation, this also applies to non-EU GIs in the relevant product fields that enjoy protection in the territory of a Member State through an international agreement concluded between that Member State and a non-EU country.

This interpretation also applies to international agreements signed exclusively by Member States with non-EU countries. [Article 7\(1\)\(j\) EUTMR](#) only applies to GIs for *craft and industrial products* protected under such agreements.

In light of the foregoing, for the purposes of [Article 7\(1\)\(j\) EUTMR](#), international agreements concluded by Member States are not applicable except in the following circumstances:

- To the extent that they cover GIs for *craft and industrial products*. Currently, neither the Commission nor the Office keeps a database listing the GIs for *craft and industrial products* protected under international agreements concluded by Member States.
- In the case of international agreements concluded with non-EU countries by a Member State before its accession to the EU. This is because the obligations arising out of an international agreement entered into by a Member State before its accession to the EU have to be respected. However, Member States are required to take all appropriate steps to eliminate incompatibility between an agreement concluded before a Member State's accession and the Treaty (see Article 307, Treaty Establishing the European Community, now Article 351 TFEU, as interpreted by the Court in its judgment of 18/11/2003, [C-216/01](#), Budějovický Budvar, EU:C:2003:618, § 168-172).
- In the case of international agreements concluded with a non-EU country by a Member State after its accession to the EU but before the entry into force of the uniform EU system of protection in the given product area.

Given the inherent difficulty in identifying such GIs, the Office will in these cases rely principally on observations by third parties. Additionally, the Office will consider raising an objection based on [Article 7\(1\)\(g\) EUTMR](#) if, in the course of proceedings and, in particular, in light of third-party observations, it becomes evident that the trade mark would deceive the public.

### 6.3 Relationship with other EUTMR provisions

When the mark can be objected to under [Article 7\(1\)\(j\) EUTMR](#), further examination may still be necessary under the remaining possible grounds for refusal, such as [Article 7\(1\)\(c\), \(g\), \(k\) or \(l\) EUTMR](#).

Moreover, an EUTM application may be in conflict with both a GI in the *wine* sector and a protected traditional term for *wines* or with both a GI in the *agricultural and foodstuffs* sector and a traditional speciality guaranteed.

GI	TTW/TSG	EUTM application (invented)
<a href="#">JAMÓN DE SERÓN</a> (PGI-ES-1052)	Jamón serrano	ABC Jamón serrano de Serón for <i>ham</i>

<a href="#">ALICANTE</a> (PDO-ES-A1526)	Fondillón	ABC Fondillón Alicante for <i>wine</i>
--	-----------	--

*Example*

GI/TTW	EUTM	Limitation
<a href="#">RIOJA</a> (PDO-ES-A0117)  <b>RESERVA</b>	MARQUÉS DE SAN JUAN RESERVA 2010 RIOJA  (invented example)	<i>'Rioja'</i> (GI) wine and <i>'Reserva'</i> (TTW) wine

Finally, and importantly, when a **registered trade mark** is subsequently used (on the market) on goods that are not genuine products for which the limitation was indicated in the list of goods and/or services, the trade mark can be revoked under [Article 58\(1\)\(c\) EUTMR](#). For further information, see the Guidelines, [Part B, Examination, Section 4, Absolute Grounds for Refusal, Chapter 8, Deceptive Trade Marks \(Article 7\(1\)\(g\) EUTMR\), paragraph 4](#), and [Part D, Cancellation, Section 2, Substantive provisions, paragraph 2.4](#).

***GUIDELINES FOR EXAMINATION OF  
EUROPEAN UNION TRADE MARKS***

***EUROPEAN UNION  
INTELLECTUAL PROPERTY OFFICE  
(EUIPO)***

***Part B***

***Examination***

***Section 4***

***Absolute grounds for refusal***

***Chapter 11 Trade marks in conflict with  
traditional terms for wines (Article 7(1)(k)  
EUTMR)***

## Table of Contents

<b>1 Article 7(1)(k) EUTMR.....</b>	<b>663</b>
<b>2 General Remarks on EU Regulations.....</b>	<b>663</b>
2.1 Definition of TTWs under EU Regulations.....	663
<b>3 Relevant TTWs under EU Regulations.....</b>	<b>664</b>
3.1 Relevant point in time.....	665
<b>4 Relevant provisions governing conflicts with trade marks.....</b>	<b>665</b>
<b>5 Relevant Goods.....</b>	<b>670</b>
5.1 Restrictions of the list of goods.....	671
<b>6 International Agreements.....</b>	<b>671</b>
<b>7 Relationship with other EUTMR Provisions.....</b>	<b>671</b>

## 1 Article 7(k) EUTMR

[Article 7\(1\)\(k\) EUTMR](#) applies to EUTMs that are in conflict with traditional terms for wine (TTWs) protected by either EU legislation or international agreements to which the EU is party.

## 2 General Remarks on EU Regulations

Protection of TTWs is provided for in [Council Regulation \(EU\) No 1308/2013](#), in [Chapter III of Commission Implementing Regulation \(EU\) 2019/34](#) and in [Chapter III of Commission Delegated Regulation \(EU\) 2019/33](#) <sup>(31)</sup>, which lay down certain detailed rules for the implementation of the Council Regulation (implementing and delegated acts).

### 2.1 Definition of TTWs under EU Regulations

As regards the definition of TTWs, recital 104 of [Council Regulation \(EU\) No 1308/2013](#) indicates that ‘Certain terms are traditionally used in the Union to convey information to consumers about the particularities and the quality of wines, complementing the information conveyed by protected designations of origin and geographical indications. In order to ensure the working of the internal market and fair competition and to avoid consumers being misled, those traditional terms should be eligible for protection in the Union.’

Similarly, recital 23 of [Commission Delegated Regulation \(EU\) 2019/33](#) states that,

[t]he use of traditional terms to describe grapevine products is a long-established practice in the Union. Such terms designate a production or ageing method, the quality, colour, type of place or a particular event linked to the history of a grapevine product bearing a protected designation of origin or geographical indication or indicate that it is a grapevine product having a protected designation of origin or geographical indication. Articles 112 and 113 of Regulation (EU) No 1308/2013 lay down the general rules regarding the use and protection of traditional terms. So as to ensure fair competition and avoid misleading consumers, a common framework should be laid down regarding the protection and registration of such traditional terms.

---

<sup>31</sup> [Commission Implementing Regulation \(EU\) 2019/34](#) of 17 October 2018 laying down rules for the application of [Regulation \(EU\) No 1308/2013](#) of the European Parliament and of the Council as regards applications for protection of designations of origin, geographical indications and traditional terms in the wine sector, the objection procedure, amendments to product specifications, the register of protected names, cancellation of protection and use of symbols, and of [Regulation \(EU\) No 1306/2013](#) of the European Parliament and of the Council as regards an appropriate system of checks OJ L 9, 11.1.2019, pages 46-76, and [Commission Delegated Regulation \(EU\) 2019/33](#) of 17 October 2018 supplementing [Regulation \(EU\) No 1308/2013](#) of the European Parliament and of the Council as regards applications for protection of designations of origin, geographical indications and traditional terms in the wine sector, the objection procedure, restrictions of use, amendments to product specifications, cancellation of protection, and labelling and presentation, OJ L 9, 11.1.2019, pages 2-45.

According to [Article 112 of Council Regulation \(EU\) No 1308/2013](#), a ‘traditional term’ is a term traditionally used in a Member State to designate:

- that the product has a protected designation of origin or a protected geographical indication under EU or national law; or
- the production or ageing method or the quality, colour, type of place, or a particular event linked to the history of the product with a protected designation of origin or a protected geographical indication.

In the first case a TTW is used in addition to the reference to a *protected designation of origin* (PDO) (e.g. ‘appellation d’origine contrôlée (AOC)’, ‘denominación de origen protegida (DO)’, ‘denominazione di origine controllata (DOC)’, ‘Landwein’) or a *protected geographical indication* (PGI) (‘Vin de Pays’, ‘Vino de la Tierra’, ‘Indicazione Geografica Tipica’, ‘Vinho Regional’, ‘Landwein’).

In the second case a TTW is used as a description of product characteristics used for production or ageing methods, quality, colour, type of place, or for a particular event linked to the history of the product with a PDO or PGI (e.g. ‘château’, ‘grand cru’, ‘añejo’, ‘clásico’, ‘crianza’, ‘riserva’, ‘fino’, ‘Federweisser’).

That said, TTWs convey information to consumers about the particularities and the quality of wines, in principle complementing the information conveyed by PDOs and PGIs, for example, ‘Gran Reserva de Fondillón’ for wine of overripe grapes of PDO [Alicante](#), ‘Cru bourgeois’ for wine from PDO [Médoc](#).

In accordance with [Article 25 of Commission Implementing Regulation \(EU\) 2019/34](#), protected traditional terms are recorded by the Commission in an electronic register, and will mention the following data:

1. the name to be protected as a traditional term;
2. the type of traditional term according to [Article 112 of Regulation \(EU\) No 1308/2013](#);
3. the language referred to in [Article 24 of Delegated Regulation \(EU\) 2019/33](#);
4. the grapevine product category or categories concerned by the protection;
5. a reference to the national legislation of the Member State or third country in which the traditional term is defined and regulated or to the rules applicable to wine producers in the third country, including those originating from representative trade organisations, in the absence of national legislation in those third countries;
6. a summary of the definition or conditions of use;
7. the name of the country or countries of origin;
8. the date of inclusion in the register.

The [eAmbrosia](#) search tool provides information about TTWs protected in the EU.

### 3 Relevant TTWs under EU Regulations

[Article 7\(1\)\(k\) EUTMR](#) applies where a TTW (either from an EU Member State or from a third country) has been **registered** under the procedure laid down by [Council](#)

[Regulation \(EU\) No 1308/2013](#), in [Chapter III of Commission Implementing Regulation \(EU\) 2019/34](#) and in [Chapter III of Commission Delegated Regulation \(EU\) 2019/33](#).

Relevant information about TTWs can be found in the [eAmbrosia](#) database maintained by the Commission.

### 3.1 Relevant point in time

[Article 7\(1\)\(k\) EUTMR](#) applies only to TTWs applied for before the EUTM application and registered at the time of examining the EUTM application.

The relevant dates for establishing the priority of a trade mark and of a TTW are the date of application of the EUTM (or the so-called Paris Convention priority, if claimed) and the date of application for protection of a TTW to the Commission, respectively.

Where there is no relevant date information in the [eAmbrosia](#) extract, this means that the TTW in question was already in existence on 01/08/2009, the date on which the register was set up. For any TTW added subsequently, the [eAmbrosia](#) extract includes a reference to the publication in the Official Journal, which gives the relevant information.

By analogy with the current practice for GIs, and in view of the fact that the vast majority of applications for TTWs usually mature into a registration, **an objection will be raised** when the TTW was applied for before the filing date (or the priority date, if applicable) of the EUTM application **but** had not yet been registered at the time of examination of the EUTM application. However, if the EUTM applicant indicates that the TTW in question has not yet been registered, the proceedings will be suspended until the outcome of the registration procedure for the TTW.

## 4 Relevant provisions governing conflicts with trade marks

TTWs do not constitute intellectual or industrial property rights like GIs. They are either **used in addition to the reference to GIs** (e.g. ‘vino de la tierra, appellation d’origine contrôlée’) or **provide information to consumers on the production/ageing method, quality, colour or type of place or a particular event linked to the history of the wine** (e.g. Cannellino, reserva, clasico, château, añejo, cru classé, Amarone). Therefore, they should not be regarded as indicators of the geographical provenance of the wine (17/05/2011, [T-341/09](#), Txacoli, EU:T:2011:220, § 33).

Nevertheless, some of the protected TTWs **are associated with the use of a (particular) GI**. For instance, the TTW ‘Cannellino’ is an exclusive term related to a type of [Frascati](#) wine and to its production. [Frascati](#) is a PDO.

The scope of protection of protected TTWs **is narrower** than that of GIs. Pursuant to [Article 113\(2\) of Council Regulation \(EU\) No 1308/2013](#), TTWs are protected, **only in**



**the language and for the categories of grapevine products claimed in the application** for protection of a TTW.

A specific provision on the relationship of traditional terms for wines with trade marks (a provision analogous to [Article 102 of Council Regulation \(EU\) No 1308/2013](#) governing GIs) is found in [Article 32 of Commission Delegated Regulation \(EU\) 2019/33](#). According to this article:

1. The registration of a trade mark that **contains or consists of a traditional term** which does not respect the definition and conditions of use of that traditional term as referred to in [Article 112 of Regulation \(EU\) No 1308/2013](#), and that relates to a product falling under one of the categories listed in Part II of Annex VII thereto shall be:
  - a. refused if the application for registration of the trade mark is submitted after the date of submission of the application for protection of the traditional term to the Commission and the traditional term is subsequently protected; or
  - b. invalidated.
2. A name shall not be protected as a traditional term where, in the light of a trade mark's reputation and renown, such protection is liable to mislead the consumer as to the true identity, nature, characteristic or quality of the grapevine product.
3. Without prejudice to paragraph 2, a trade mark referred to in paragraph 1 which has been applied for, registered or established by use in good faith, where national legislation so provides, in the territory of the Union, prior to the date of protection of the traditional term in the country of origin, may continue to be used and renewed notwithstanding the protection of a traditional term, provided that no grounds for the trade mark's invalidity or revocation exist under [Directive 2008/95/EC](#) of the European Parliament and of the Council (<sup>32</sup>), [Directive \(EU\) 2015/2436](#) of the European Parliament and of the Council (<sup>33</sup>) or under [Regulation \(EU\) 2017/1001](#) of the European Parliament and of the Council (<sup>34</sup>).

In such cases, the use of the traditional term will be permitted alongside the relevant trade marks.

The Office does not automatically object to trade marks that include a term that is also a TTW. It raises an objection only in the event of misuse or false/misleading use of the TTW. The list of protected TTWs includes terms that are fairly common or that have various meanings not necessarily related to wines (such as 'NOBLE', 'CLASICO' or 'RESERVA'). Depending on the context in which these terms are used, they may or may not be associated with wine quality. As a consequence, when examining the sign, the Office will take into account in particular whether the relevant public will link the term in the sign with certain qualities or characteristics of the wine or not.



An objection was raised in the following examples.

---

<sup>32</sup> Directive 2008/95/EC of the European Parliament and of the Council of 22 October 2008 to approximate the laws of the Member States relating to trade marks, [OJ L 299, 8.11.2008, p. 25](#).

<sup>33</sup> Directive (EU) 2015/2436 of the European Parliament and of the Council of 16 December 2015 to approximate the laws of the Member States relating to trade marks (Recast), [OJ L 336, 23.12.2015, p. 1](#).

<sup>34</sup> Regulation (EU) 2017/1001 of the European Parliament and of the Council of 14 June 2017 on the European Union trade mark, [OJ L 154, 16.6.2017, p. 1](#).

Case No	Comment
<p>EUTM No 17 476 656</p> 	<p>CHÂTEAU is, inter alia, a historical expression related to a type of area and type of wine, and is reserved for wines originating from an estate that actually exists and/or has the exact word in its name.</p> <p>The relevant public will link the term 'château' in the sign with the traditional term 'Château'. The TM is therefore objectionable.</p> <p>As a result, the specification in Class 33 was limited to: <i>Wines complying with the definition/conditions of use of the traditional term for wines 'Chateau'; alcoholic beverages (other than wines).</i></p>
<p>EUTM No 17 967 391</p> 	<p>'Viejo' is a Spanish TTW for liqueur wine and for wines with a GI. 'Pulgar' is a term used in the wine field to refer to the part of the branch with two or three buds that is left in the vines when pruning them, so that the shoots can sprout (as depicted in the sign).</p> <p>The Office considered that, despite the fact that 'viejo' is not only a TTW but also a commonly used term to refer to 'old', and considering the elements of the sign all point to the wine field, there existed a conflict with the TTW 'viejo'.</p> <p>As a result, the specification in Class 33 was limited to: <i>wines complying with the definition/conditions of use of the traditional term for wine 'Viejo'; alcoholic beverages (except beers and wines).</i></p>
<p>EUTM No 17 874 618</p> <p>EL CLÁSICO</p>	<p>'Clásico' is a Spanish TTW for liqueur wines and wine of overripe grapes. The sign was applied for in respect of <i>wines</i>.</p> <p>The relevant public will link the term 'clásico' in the sign with the TTW 'Clásico'. The trade mark is therefore objectionable.</p>

No objection was raised in the following examples.

Case No	Comment

EUTM No 15 102 015



The addition of the term 'RESERVA' within the expression 'RESERVA DE LA BIOSFERA' does not misuse or give misleading/false information with regard to the TTW 'reserva'.

The term 'reserva' in the TM should not be assessed out of context.

'Reserva' is not only a TTW but also has, in the present case, another meaning, which has no obvious link with the TTW: in the EUTM application, combined with the word 'biosfera', 'reserva' clearly refers to a 'natural space'. Note also that the sign does not refer expressly to a wine.

In light of the above, the expression 'RESERVA DE LA BIOSFERA', read as a whole, constitutes a logical and conceptual unit, in which 'RESERVA' is qualified by the other terms: 'DE LA BIOSFERA'. There is no direct link being made with the TTW 'RESERVA' as clearly the term will not be identified as providing information on the quality of wine.

Moreover, the structure of the sign confirms that 'reserva' is not used in isolation or in a different typeface or size.

The TM is acceptable.

EUTM No 14 997 803

**Noble Dragon**

The inclusion of the term 'NOBLE' in the expression 'NOBLE DRAGON' does not misuse or give misleading/false information with regard to the TTW NOBLE.

'Noble' is not only a TTW but also has, in the present case, another meaning, which has no obvious link with the TTW.

In this particular case, the expression 'NOBLE DRAGON' constitutes a logical and conceptual unit, in which 'NOBLE' directly qualifies the term 'DRAGON' and therefore does not provide information on the quality of the wine, for example that it is 'noble' wine.

The structure of the sign confirms that 'noble' is not used in isolation or in a different typeface or size.

This conclusion is valid for average consumers in the EU: either they will understand the expression 'NOBLE DRAGON' as a conceptual unit or, even if they do not attribute any meaning to the sign as a whole, given the structure of the sign, in particular the arrangement of the words and the size and typeface in which they are reproduced, the term 'NOBLE' will not evoke in their minds anything particular about the wine.

The TM is acceptable.

<p>Invented EUTM application</p> <p><b>AXN Late Harvest</b></p>	<p>'Vendange Tardive' is a French TTW. It is protected only in French.</p> <p>The translation of the TTW into English is not objectionable.</p> <p>See also the EU Commission's reply to Parliamentary question E-0622/2006, where it confirmed that the TTW 'Vendange Tardive' is protected only in French for certain wines originating in France. As traditional expressions are only protected in the language in which they are listed, the expression 'Late Harvest' is not protected in the EU.</p> <p>( <a href="http://www.europarl.europa.eu/sides/getAllAnswers.do?reference=E-2006-0622&amp;language=EN">http://www.europarl.europa.eu/sides/getAllAnswers.do?reference=E-2006-0622&amp;language=EN</a> )</p>
<p>EUTM No 17 633 819</p> <p>PAGOS DE GALIR</p>	<p>'Vino de pago' is a Spanish TTW. In the absence of the whole reference to 'vino de pago', the sign does not contain or consist of the TTW as registered.</p>

## 5 Relevant Goods

[Article 113\(2\) of Council Regulation \(EU\) No 1308/2013](#) refers to ' **categories of grapevine products claimed in the [TTW] application** '. Similarly, [Article 32 of Commission Delegated Regulation \(EU\) 2019/33](#) refers to a product falling under one of these categories. The Office interprets this as meaning that, unlike GIs, objections based on conflicts with TTWs cannot be raised for comparable goods. However, objections should be raised against any relevant product referred to in [Article 92\(1\) of Council Regulation \(EU\) No 1308/2013](#) for the following reasons.

According to [Article 92\(1\) of Council Regulation \(EU\) No 1308/2013](#) the rules on, inter alia, traditional terms should apply to the products referred to in points 1, 3 to 6, 8, 9, 11, 15 and 16 of Part II of Annex VII. Such products are *wine, liqueur wine, sparkling wine, quality sparkling wine, quality aromatic sparkling wine, semi-sparkling wine, aerated semi-sparkling wine, partially fermented grape must, wine from raisined grapes, wine of overripe grapes* .

Since all these products are wine - based and in view of the fact that most of the EUTM applications applied for are for *wines* without any specification of category, objections should be raised against any relevant product referred to in [Article 92\(1\) of Council Regulation \(EU\) No 1308/2013](#) . For instance, in the event of an EUTM application containing the TTW 'Fondillón', for *wine* in Class 33, the objection should be raised not

against *wine of overripe grapes* that is protected by the TTW, but against *wine* as such (e.g. '*Fondillón*' (TTW) wine ).

## 5.1 Restrictions of the list of goods

Objections raised due to conflicts with GIs may be waived if the relevant goods are restricted so as to comply with the specifications of the GI in question.

For TTWs, there are no such specifications but [eAmbrosia](#) search tool includes a 'summary of definition/conditions of use'. Therefore, objections should be waived if the relevant goods are restricted so as to comply with the definition/conditions of use of the TTW in question. The Office recommended wording is "[traditional term]' (TTW) [product]'. Other wordings are, however, acceptable as long as the applicant clearly identifies the TTW and use thereof.

## 6 International Agreements

By analogy with GIs, where international agreements to which the EU is party can serve as a basis for raising an objection against a trade mark application, TTWs that may be protected under international agreements to which the EU is a party should be taken into account when assessing conflicts between a TTW and an EUTM application.

## 7 Relationship with other EUTMR Provisions

When the mark can be objected to under [Article 7\(1\)\(k\) EUTMR](#) , further examination may still be necessary under the remaining possible grounds for refusal, such as [Article 7\(1\)\(j\) EUTMR](#) .

In other words, an EUTM application may be in conflict with both a GI in the wine sector and a TTW.

### Examples

GI/TTW	EUTM	Limitation
<b>RIOJA</b> (PDO-ES-A0117)	MARQUÉS DE SAN JUAN RESERVA 2010 RIOJA	<i>'Rioja'</i> (GI) wine and <i>'Reserva'</i> (TTW) wine
<b>RESERVA</b>	(invented example)	

Moreover, the mark consisting of the TTW can also be objected to under [Article 7\(1\)\(b\)/\(c\) EUTMR](#) .

### Examples

TTW	EUTM	Explanation
AÑEJO	VINO AÑEJO applied for <i>wines; alcoholic beverages except beers</i> (invented example)	'Añejo' is a Spanish TTW for 'wine' aged for a minimum period of 24 months and for liqueur wines originating from Malaga PDO. Therefore, it is objectionable under <a href="#">Article 7(1)(k) EUTMR</a> . In addition, the sign is objectionable under <a href="#">Article 7(1)(b)/(c) EUTMR</a> as it informs the relevant consumer of certain characteristics of the wines (e.g. wine that is aged).

Finally, and importantly, when a **registered trade mark** is subsequently used (on the market) on the goods which are not genuine TTW products for which limitation was indicated in the list of goods, the trade mark can be revoked under [Article 58\(1\)\(c\) EUTMR](#). For further information, see the Guidelines, [Part B, Examination, Section 4, Absolute Grounds for Refusal, Chapter 8, Deceptive Trade Marks \(Article 7\(1\)\(g\) EUTMR\), paragraph 4](#), and [Part D, Cancellation, Section 2, Substantive provisions, paragraph 2.4](#).

***GUIDELINES FOR EXAMINATION OF  
EUROPEAN UNION TRADE MARKS***

***EUROPEAN UNION  
INTELLECTUAL PROPERTY OFFICE  
(EUIPO)***

***Part B***

***Examination***

***Section 4***

***Absolute grounds for refusal***

***Chapter 12 Trade marks in conflict with  
traditional specialities guaranteed (Article  
7(1)(I) EUTMR)***



## Table of Contents

<b>1 Article 7(1)(l) EUTMR.....</b>	<b>675</b>
<b>2 General Remarks on EU Regulations.....</b>	<b>675</b>
2.1 Definition of traditional specialities guaranteed under EU Regulations.....	675
2.2 Relationship with trade marks.....	676
2.2.1 TSG with or without reservation of a name.....	676
<b>3 Relevant TSGs Under EU Regulations.....</b>	<b>677</b>
3.1 Relevant point in time.....	677
<b>4 Situations Covered by Article 24 of Regulation (EU) No 1151/2012.....</b>	<b>678</b>
<b>5 Relevant goods.....</b>	<b>679</b>
5.1 Restrictions of the list of goods.....	679
<b>6 International Agreements.....</b>	<b>679</b>
<b>7 Relationship with other EUTMR provisions.....</b>	<b>679</b>

## 1 Article 7(I) EUTMR

Article 7(1)(I) EUTMR applies to EUTMs that are in conflict with traditional specialities guaranteed (TSGs) protected by either EU legislation or international agreements to which the EU is party.

## 2 General Remarks on EU Regulations

### 2.1 Definition of traditional specialities guaranteed under EU Regulations

Protection of TSGs is provided for in [Title III of Regulation \(EU\) No 1151/2012](#).

As regards the definition of TSGs, [Article 17 of Regulation \(EU\) No 1151/2012](#) indicates that '[a] scheme for traditional specialities guaranteed is established to safeguard traditional methods of production and recipes by helping producers of traditional product[s] in marketing and communicating the value-adding attributes of their traditional recipes and products to consumers.'

According to [Article 18\(1\)](#) of the Regulation,

[a] name shall be eligible for registration as a traditional speciality guaranteed where it describes a specific product or foodstuff that:

1. results from a mode of production, processing or composition corresponding to traditional practice for that product or foodstuff; or
2. is produced from raw materials or ingredients that are those traditionally used.

Hence, TSGs highlight the traditional characteristics of a product either in its production process or composition, for instance, 'Lambic, Gueuze-Lambic, Gueuze' for *Belgian acid beer during production of which spontaneous fermentation occurs*.

Unlike GIs, the TSG quality scheme does not certify that the protected food product has a link to a specific geographical area, for instance, TSG 'Mozzarella' for *Italian fresh pulled-curd cheese* and PDO '[Mozzarella di Bufala Campana](#)' for mozzarella cheese originating from a particular geographical area.

To qualify as a TSG, a product must, according to [Article 18\(2\)](#) of the Regulation, be of a specific character: '2. For a name to be registered as a traditional speciality guaranteed, it shall:

1. have been traditionally used to refer to the specific product; or
2. identify the traditional character or specific character of the product.'

In this context, reference is made to [Article 3 of Regulation \(EU\) No 1151/2012](#), which defines:

1. 'specific character' as 'the characteristic production attributes which distinguish a product clearly from other similar products of the same category';

2. 'traditional' as 'proven usage on the domestic market for a period that allows transmission between generations; this period is to be at least 30 years.'

According to [Article 23 of Regulation \(EU\) No 1151/2012](#), '[a] name registered as a traditional speciality guaranteed may be used by any operator marketing a product that conforms to the corresponding specification'.

[Article 24 of Regulation \(EU\) No 1151/2012](#) establishes the scope of protection of TSGs — '[r]egistered names shall be protected against any misuse, imitation or evocation, including as regards products used as ingredients, or against any other practice liable to mislead the consumer'.

## 2.2 Relationship with trade marks

In contrast with GIs, there is no specific provision in [Regulation \(EU\) No 1151/2012](#) for the relationship of TSGs with trade marks (i.e. a provision analogous to [Article 13](#)). [Article 24\(1\)](#) prohibits the use of the TSG in a number of situations but not the registration of a trade mark.

[Article 7\(1\)\(l\) EUTMR](#), however, refers to 'trade marks which are excluded from registration pursuant to Union legislation'.

The Office considers that a systematic approach should be followed and draws an analogy with [Article 7\(1\)\(j\) EUTMR](#): the registration of an EUTM application should be refused or the registration of an EUTM invalidated if there is conflict with a TSG.

### 2.2.1 TSG with or without reservation of a name

Under [Regulation \(EC\) No 509/2006](#) on agricultural products and foodstuffs as traditional specialities guaranteed, and more specifically [Article 13](#) of that Regulation, the applicants had a choice of applying and subsequently registering a TSG '*with or without reservation of name*'. It meant that for a TSG registered '*without the reservation of name*', the respective name remained free to use to any operators without any limitation. Information on whether the TSG has been registered with or without reservation of the name is found in the Official Journal publishing the registration of the TSG in the C series.

[Regulation \(EC\) No 509/2006](#) was repealed by [Regulation \(EU\) No 1151/2012](#) on quality schemes for agricultural products and foodstuffs. The subsequent regulation provides **only** for registering of TSGs '*with reservation of name*'. The transitional provisions of [Article 25](#) deal with the incompatibility of the old and new regimes. All the TSGs that were registered '*with reservation of name*' are entered automatically into the register. For those TSGs the Office will refuse the EUTM should there be a conflict. On the contrary, all the TSGs that were registered '*without reservation of name*' remain on the register only until 4 January 2023, unless the applicants opted for a 'simplified procedure' under [Article 26](#), to have a TSG in the register '*with the reservation of name*'.

In the latter cases, the Office will refuse signs in conflict with the TSG.

EUTM No	Comment
<p>EUTM No 17 238 197</p>  <p>The logo features the word 'NAPOLI' in a large, serif font, with '1020' below it in a similar font. Underneath '1020' is a horizontal line, and below that, the text 'PIZZA &amp; CUCINA D'AUTORE' is written in a smaller, sans-serif font.</p>	<p>The sign is in conflict with the TSG 'Pizza Napoletana' (registered on 05/02/2010 '<i>without reservation of name</i>' but applied for with reservation of name).</p> <p><i>Pizzas</i> in Class 30 had to be limited to comply with the product specification of the TSG 'Pizza Napoletana'.</p>

If a TSG was registered '*without reservation of name*', the Office would not *ex officio* refuse an EUTM containing the TSG unless the sign itself indicated 'TSG' or 'traditional specialities guaranteed'. Examples of TSGs '*without reservation of name*' are:

- TSG-BE-0008, 'Kriek / Kriek-Lambic / Framboise-Lambic / Fruit-Lambic / Kriek / Kriekenlambiek / Frambozenlambiek / Vruchtenlambiek';
- TSG-ES-0003, 'Leche certificada de Granja';
- TSG-ES-0018, 'Panellets';
- TSG-SE-0022, 'Hushållsost'.

### 3 Relevant TSGs Under EU Regulations

[Article 7\(1\)\(l\) EUTMR](#) applies where a TSG has been registered under the procedure laid down by [Regulation \(EU\) No 1151/2012](#).

Relevant information about traditional specialities guaranteed can be found in the [eAmbrosia](#) register maintained by the Commission.

#### 3.1 Relevant point in time

[Article 7\(1\)\(l\) EUTMR](#) applies only to TSGs that were applied for before the EUTM application and are **registered** at the time when the EUTM application was examined.

By analogy with the current practice for GIs and in view of the fact that the vast majority of applications for TSGs usually mature into a registration, an objection will be raised when the TSG was applied for before the filing date (or the priority date, if applicable) of the EUTM application but is not yet registered at the time when the EUTM application was examined. If the EUTM applicant does not submit observations or does not overcome the objection, the Office will suspend the examination proceedings until the TSG registration proceedings are concluded.

## 4 Situations Covered by Article 2 of Regulation (EU) No 1151/2012

TSGs are used to provide information on particular methods of production and recipes. Importantly, unlike GIs, there is no link between a TSG and a specific geographical area.

The scope of protection of protected TSGs is narrower than that of GIs. Pursuant to [Article 24 of Regulation \(EU\) No 1151/2012](#), TSGs are protected against any misuse, imitation or evocation, including as regards products used as ingredients, or against any other practice liable to mislead the consumer. The exploitation of the reputation of the TSG is not contemplated.

The Office will apply by analogy its interpretation of the products used as ingredients, and terms such as misuse, imitation or evocation and the misleading practices referred to in [Article 13 of Regulation \(EU\) No 1151/2012](#) in connection with GIs (see the Guidelines, [Part B, Examination, Section 4, Absolute Grounds for Refusal, Chapter 10, Geographical Indications \(Article 7\(1\)\(j\) EUTMR\)](#)). The Office will take into account, in particular, whether the relevant public will link the term in the sign with the product whose designation is covered by the TSG.

EUTM No	Comment
<p>EUTM No 15 270 184 HEUMILCHBARON</p>	<p>HEUMILCH is a registered TSG for milk (haymilk) (TSG-AT-01035-AM01).</p> <p>The relevant public will link the term 'heumilch' in the sign with the product whose designation is covered by the TSG. The EUTM application is therefore objectionable.</p> <p>As a result, the specification in Class 29 was limited to: <i>Milk and milk products, in particular cheese, cheese preparations, cream cheese, soft cheese, semi-hard cheese, sliced cheese, hard cheese, cream, milk cream, whey, yoghurt, curds, butter, drinking yoghurt, buttermilk, curd, kefir [milk beverage], sour cream, smetana [sour cream], mixed milk products, fruit yoghurt, milk beverages, milk predominating, semi-prepared and prepared meals based mainly on milk or milk products, dairy foods; edible spreads; all of the aforesaid goods complying with the product specification of the Traditional Speciality Guaranteed 'Heumilch'.</i></p>

## 5 Relevant goods

[Article 19 of Regulation \(EU\) No 1151/2012](#) requires that a TSG complies with a specification which must comprise a 'description of the product including its main physical, chemical, microbiological or organoleptic characteristics, showing the product's specific character'.

The Office will only raise objections for products covered by the TSG or where such products are used as commercially relevant ingredients.

### 5.1 Restrictions of the list of goods

TSG applications, in accordance with [Article 20 of Regulation \(EU\) No 1151/2012](#), must comprise a product specification. Therefore, objections should be waived if the relevant goods are restricted to comply with the product specification of the TSG. The wording that the Office recommends is "[TSG name] (TSG) [product covered by the TSG]". Other wordings are, however, acceptable as long as the applicant clearly identifies the TSG and use thereof.

The TSG product specifications are available in the [eAmbrosia](#) register.

For an example of restrictions of the list of goods see [paragraph 4](#).

## 6 International Agreements

By analogy with GIs, where international agreements to which the EU is party can serve as a basis for raising an objection against a trade mark application, TSGs that may be protected under international agreements to which the EU is a party should be taken into account in the assessment of conflict of a TSG with an EUTM application.

Currently, however, there are no TSGs protected under international agreements.

## 7 Relationship with other EUTMR provisions

When the mark can be objected to under [Article 7\(1\)\(l\) EUTMR](#), further examination may still be necessary under the remaining possible grounds for refusal, such as [Article 7\(1\)\(j\) EUTMR](#).

In other words, an EUTM application may be in conflict with both a GI in the agricultural and foodstuff sector and a protected traditional speciality guaranteed.

Finally, and importantly, if a **registered trade mark** is subsequently used (on the market) on goods that are not genuine TSG products for which limitation was indicated in the list of goods, the trade mark can be revoked under [Article 58\(1\)\(c\) EUTMR](#). For further information, see the Guidelines, [Part B, Examination, Section 4, Absolute grounds for refusal, Chapter 8, Deceptive trade marks \(Article 7\(1\)\(g\) EUTMR\)](#).

[paragraph 4.2.1](#), and [Part D, Cancellation, Section 2, Substantive provisions, paragraph 2.4](#).

***GUIDELINES FOR EXAMINATION OF  
EUROPEAN UNION TRADE MARKS***

***EUROPEAN UNION  
INTELLECTUAL PROPERTY OFFICE  
(EUIPO)***

***Part B***

***Examination***

***Section 4***

***Absolute grounds for refusal***

***Chapter 13 Trade marks in conflict with  
earlier plant variety denominations (Article  
7(1)(m) EUTMR)***



## Table of Contents

<b>1 Article 7(1)(m) EUTMR.....</b>	<b>683</b>
<b>2 Legislative Framework.....</b>	<b>683</b>
<b>3 Definition of Plant Variety Denomination.....</b>	<b>684</b>
<b>4 Situations Covered by Article 7(1)(m) EUTMR.....</b>	<b>684</b>
4.1 Registered plant variety denominations.....	684
4.2 Relevant point in time.....	686
4.3 The EUTM application consists of, or reproduces in its essential elements, the plant variety denomination.....	686
4.4 Plant varieties of the same or closely related species.....	690
4.5 Relationship with other EUTMR provisions.....	691

## 1 Article 7()(m) EUTMR

[Regulation \(EU\) 2015/2424](#) amending [Council Regulation \(EC\) No 207/2009](#) on the Community trade mark introduced [Article 7\(1\)\(m\)](#) as a specific ground for objecting to trade marks in conflict with earlier plant variety denominations.

In particular, [Article 7\(1\)\(m\) EUTMR](#) provides for the refusal of EUTMs that consist of, or reproduce in their essential elements, an earlier plant variety denomination — registered in accordance with EU legislation, national law or international agreements to which the European Union or the Member State concerned is a party and that provide for the protection of plant variety rights — and that are filed in respect of plant varieties of the same or closely related species.

## 2 Legislative Framework

As regards **EU legislation** protecting plant variety rights, [Council Regulation \(EC\) No 2100/94](#) of 27 July 1994 on Community plant variety rights (CPVRR) establishes a system of Community plant variety rights (CPVR) as the ‘sole and exclusive form of Community industrial property rights for plant varieties’.

**Plant variety** (PV) represents a more precisely defined group of plants, selected from within a species, with a common set of characteristics. For instance, within one of the strawberries species (e.g. *Fragaria moschata* or *Fragaria x ananassa* Duch.), a breeder may create a new variety.

New plant varieties can be protected by a *sui generis* intellectual property system of Plant Breeder’s Rights (PBR).

Since 2005, the European Union has been party to the International Convention for the Protection of New Varieties of Plants (UPOV Convention), which has become an integral part of the European Union’s legal order. Under Article 20(1) UPOV Convention, a variety ‘shall be designated by a denomination which will be its generic designation’. Furthermore, each Contracting Party must ensure that no rights in the designation registered as the denomination of the variety will hamper **free use of the denomination** in connection with the variety, even after expiry of the breeder’s right. This actually implies that an applicant cannot validly claim to be the holder of plant breeder’s rights in order to overcome an objection based on [Article 7\(1\)\(m\) EUTMR](#), even if those rights have not yet expired. The purpose of this Article is to ensure **free use** of the denomination in connection with the variety. Therefore, a plant breeder or their successor in title, owning a registered plant variety right, should not be able to claim an exclusive IP right over that designation registered as a plant variety denomination, under trade mark protection. The exclusive object that a plant variety right protects is a variety and not the denomination, which only represents its generic designation.

Both the CPVRR and the UPOV Convention make it obligatory for any person offering for sale or marketing propagating material of the protected variety to use the variety denominations, even after the expiry of the breeder's right in that variety.

Moreover, pursuant to [Article 7\(1\)\(m\) EUTMR](#), plant variety denominations registered following **national law** or **international agreements** to which Member States are a party must also be taken into account.

### 3 Definition of Plant Variety Denomination

**Plant variety denominations** identify cultivated varieties or subspecies of live plants or agricultural seeds. A variety denomination must ensure clear and unambiguous identification of the variety and fulfil several criteria (Article 63 CPVRR). The applicant for a CPVR must indicate a suitable variety denomination, which will be used by anyone who markets such variety in the territory of a member of the International Union for the Protection of New Varieties of Plants (UPOV), even after termination of the breeder's right (Article 17 CPVRR).

Protection is granted to plant variety denominations in order, inter alia, to protect the **legitimate interest** of consumers and producers in knowing the variety they are using or purchasing, as well as possibly the breeder and origin of that variety. The obligation to use the variety denominations contributes to the regulation of the market and to the safety of transactions in the agricultural and food sector, thus preventing counterfeiting and any potential misleading of the public.

### 4 Situations Covered by Article 7(1)(m) EUTMR

[Article 7\(1\)\(m\) EUTMR](#) applies if the following requirements are met:

1. there is a registered plant variety denomination (at EU or national level, including in third countries that are party to the UPOV Convention);
2. the plant variety denomination was registered prior to the EUTM application;
3. the EUTM application consists of, or reproduces in its essential elements, the earlier plant variety denomination;
4. the list of goods for which protection is sought for in the EUTM application includes plant varieties of the same species as, or of species closely related to, those protected by the registered plant variety denomination.

#### 4.1 Registered plant variety denominations

The Community Plant Variety Office (CPVO), based in Angers (France), is the European Union agency responsible for managing a system for the protection of plant variety rights.

The CPVO maintains a register of protected plant varieties with their respective denominations.

### Plant variety rights

Pursuant to Article 19(1) CPVRR, plant variety rights **expire** at the end of the 25th calendar year or, in the case of varieties of vine and tree species, the 30th calendar year following the year of grant.

A plant variety right is **surrendered**, pursuant to Article 19(3) CPVRR, if the holder sends a written declaration to such effect to the CPVO before expiry of the term of the right, in which case the right lapses with effect from the day following the day on which the declaration is received by the CPVO.

Plant variety rights are **terminated** *ex tunc* if the CPVO declares the Community plant variety right null and void pursuant to Article 20 CPVRR and with effect *in futuro* if the CPVO cancels the Community plant variety right pursuant to Article 21 CPVRR.

The protected varieties and the varieties whose CPVR has been terminated/surrendered, or which has expired, can be searched, based on their variety denomination and/or other search criteria, through the CPVO Variety Finder <sup>(35)</sup>, available on the CPVO's website. This reference tool can be consulted whenever the type of goods and/or services covered by the EUTM application so dictate (see [paragraph 4.4](#) below).

Accordingly, the protection of [Article 7\(1\)\(m\) EUTMR](#) applies not only to plant variety denominations of registered plant varieties, but also to the denominations of varieties for which protection has expired or has been surrendered or terminated. This is because, even after expiry of the protection, the variety may still be used in the market and breeders are obliged to use the denomination when trading in variety constituents.

### Plant variety denominations

Whenever the specification of an EUTM application refers to *live plants, agricultural seeds, fresh fruits, fresh vegetables* or equivalent wording, the Office will verify in the CPVO Variety Finder whether the term(s) making up the essential elements of the trade mark coincide(s) with a registered variety denomination or with the denomination of a variety for which protection has expired or been surrendered or terminated.

However, [Article 7\(1\)\(m\) EUTMR](#) is **not applicable** in respect of processed items in Class 31 such as *dried flowers (including flowers for decoration), dried plants, hay or straw*. Neither is it applicable in respect of *live animals, food for animals, animal feed* and equivalent wordings.

The search should extend to variety denominations registered for the European Union, Member States and non-EU countries on the basis of EU legislation, national law or international agreements to which the European Union or the Member State concerned is a party.

As already mentioned, both the CPVRR and the UPOV make it obligatory to use the variety denomination when offering a plant variety or the propagating material of a plant variety commercially, even after the termination of the Community plant variety right.

---

<sup>35</sup> <http://cpvo.europa.eu/en/applications-and-examinations/cpvo-varieties-database>

## 4.2 Relevant point in time

[Article 7\(1\)\(m\) EUTMR](#) applies only in respect of plant variety denominations that have a registration date prior to the filing date of the EUTM application. The relevant dates are the date of filing of the EUTM application (or the ‘Paris Convention priority’, if claimed) and the date of registration of the plant variety denomination.

## 4.3 The EUTM application consists of, or reproduces in its essential elements, the plant variety denomination

Pursuant to [Article 7\(1\)\(m\) EUTMR](#), objections are to be raised only if the EUTM application consists of, or reproduces in its essential elements, the plant variety denomination.

The following situations may therefore arise.

1. The EUTM applied for **consists** of an earlier plant variety denomination.
2. The EUTM applied for **contains** an earlier plant variety denomination. Whether the application is liable to be objected to or not will require a more detailed assessment. In particular, the Office will examine whether the plant variety denomination is the **essential element** of the EUTM application.

In order to determine whether a plant variety denomination is the essential element of an EUTM application (situation b) above), account must be taken of all the other elements, as these are likely to influence the outcome of the assessment. As the court has noted, it is necessary to establish whether the plant variety denomination occupies an essential position in the complex mark applied for, so that the essential function of origin of the mark, namely that of identifying the commercial origin of the products in question, is based on that plant variety denomination and not on the other elements that make up the complex mark applied for (18/06/2019, [T-569/18](#), Kordes’ Rose Monique, EU:T:2019:421, § 31-32).

In principle, a term identical to a plant variety denomination will not be considered as the essential element of an EUTM application when:

- the term identical to a plant variety denomination is visually in a **secondary position** compared with the other elements of the sign; or
- **the complexity** of the sign is such that the term that is identical to a plant variety denomination is just one of numerous elements of the sign; or
- the sign contains a conceptual meaning/message that precludes the term that is identical to a plant variety denomination from being perceived as a plant variety; or
- the combination of elements of the sign creates a single unit that should not be artificially dissected.

In principle, the term identical to a plant variety denomination will be considered one of the essential elements of the EUTM application when:

- the other elements are all visually secondary; or

- the conceptual meaning/message of the sign reinforces the perception of the term as a plant variety denomination (other elements are perceived as mere qualifiers of a plant variety, i.e. terms such as colour, size, growth or season indicators).

The objection will be waived should the applicant exclude the plant varieties protected by the plant variety denomination from its list of goods applied for.

Examples of EUTM applications containing terms identical to plant variety denominations and **objected to** under [Article 7\(1\)\(m\)EUTMR](#):

EUTM	PVD	Goods applied for in Class 31	Reasoning	Outcome
RUBY No 16 922 791	RUBY	<i>Plums; Mirabelle plums; seeds for plums and seeds for Mirabelle plums; plum trees; Mirabelle plum trees</i>	The application consists of the PVD registered for <i>Prunus armeniaca</i> L. in France and Italy.	All the goods applied for fall within the genus 'Prunus'. The application was refused.
 No 17 955 254	GIOIA	Inter alia: <i>flowers</i>	GIOIA is a PVD registered for <i>Dendrobium Sw., Dianthus L., Gerbera jamesonii Bolus ex Hook f. and Lilium L.</i>  The size and position of the PVD are visually relevant in the sign. The other verbal elements 'CREA BONTÀ' ('it creates good things') are in a secondary position and their meaning neither contradicts nor would be seen as diluting the relevance of the PVD itself.	An objection was raised, following which the application was limited to <i>agricultural products, not included in other classes; market garden produce, not processed; pips; plants; natural plants; flowers; none of the aforesaid goods belonging to the botanical genera Dendrobium, Dianthus, Gerbera and Lilium.</i>

EUTM	PVD	Goods applied for in Class 31	Reasoning	Outcome
 <p>No 17 496 019</p>	AZAHAR	Inter alia: <i>agricultural products</i>	AZAHAR is a PVD registered for <i>Gossypium hirsutum L.</i> in Spain. The additional element 'BIO' is visually secondary and could in any event be an additional indication that merely reinforces or qualifies the plant variety (organically grown AZAHAR).	The Office objected and proposed a limitation to exclude agricultural products of the genus <i>Gossypium</i> . In the absence of a reply from the applicant, the application was refused for <i>agricultural products</i> .

EUTM	PVD	Goods applied for in Class 31	Reasoning	Outcome
 No 17 916 500	EMILIA	Vegetables, <i>fresh</i> ; <i>Unprocessed vegetables</i> ; <i>Root vegetables [fresh]</i>	'Emilia' is a PVD registered for five varieties, only one of which is for vegetables ( <i>Solanum tuberosum</i> — potato).  Taking into account that potatoes can be red, the other word elements 'rossa naturale' (naturally red) were considered to reinforce/qualify the reference to/meaning of the plant variety (colour and growth indicator). Thus, the word 'EMILIA' had to be considered an essential element of the EUTM applied for.	The application was objected to and limited to <i>fresh vegetables; unprocessed vegetables; root vegetables [fresh]</i> ; <i>None of the aforesaid goods belonging to the species Solanum tuberosum L.</i>

Examples of EUTMs containing a term identical to a plant variety denomination but **not objected to** under [Article 7\(1\)\(m\)EUTMR](#):

EUTM	PVD	Reasoning
 No 17 182 114	QUALITY	Considering the size of the term 'quality' and its position in the overall arrangement of the sign, it cannot be considered an essential element of the EUTM.



EUTM	PVD	Reasoning
Rubisgold No 18 016 793	RUBIS	The term 'rubis' is conjoined with the word 'gold'. A new unit is formed and must be examined as such. No artificial dissection should be applied.
 No 17 144 387	CHOICE	The verbal elements ('butcher's choice') and the figurative elements (in particular, the knife and the meat cleaver) clearly constitute a very specific logical unit with a clear conceptual meaning, which does not reinforce or point to any possible perception of a plant variety within the EUTM.
KELP-P-MAX No 17 979 018	MAX	The term 'max' was not considered an essential element of the EUTM since the overall combination of the word elements create a single unit that cannot be artificially split to highlight the word 'MAX' or the possible perception of 'max' as a plant variety denomination.

#### 4.4 Plant varieties of the same or closely related species

A check is to be made whenever the specification of an EUTM application refers to *live plants, agricultural seeds, fresh fruits, fresh vegetables* or equivalent.

If the check shows that the word or figurative EUTM applied for consists of, or reproduces in its essential elements, an earlier plant variety denomination registered under EU law, national law or relevant international agreements, the examiner must raise an objection under [Article 7\(1\)\(m\) EUTMR](#) in respect of the relevant product.

Taking as an example the scientific name of the product 'oats', *Avena sativa*, the term *Avena* describes the genus and includes the closely related species *Avena abyssinica*, *Avena byzantine*, *Avena fatua*, *Avena nuda*, etc. Similarly, the scientific name of the most common pepper is *capsicum annuum*. The term *capsicum* describes the genus and in principle includes the closely related species *Capsicum baccatum*, *Capsicum chinense*, *Capsicum pubescens*, etc.

**RULE** . The objection should refer to the genus of the scientific name of the plant variety denomination, which covers closely related species. Wherever possible, the Office will propose a limitation by which the relevant goods are limited to goods other than those of the genus of the plant variety (for example, in the case of GIOIA above, the application was limited for flowers to *flowers; other than those of the botanical genera Dendrobium, Dianthus, Gerbera and Lilium* ). If the applicant agrees with the limitation, the application will proceed to further examination.

**EXCEPTION** . There are cases where some species within the same genus are not closely related to the others, or where species from different genera are closely related.

In the first case (species within the same genus are not closely related, e.g. certain species under the genus *Solanum* ), Office practice, given the difficulty in proposing limitations, is to take into account the whole genus when proposing such limitation. It would be up to the applicant to comment on this and make a proposal.

In the second case (species from different genera are closely related, e.g. *Agrostis, Dactylis, Festuca, Festulolium, Phaklaris, Phleum and Poa* ), the Office takes such species into account when drafting the objection.

The list of exceptions is exhaustive. See [Annex I to the Explanatory Notes on Variety Denominations](#) under the UPOV Convention.

Exceptions will be examined by the Office upon request from the EUTM applicant.

See also the Annex of the [CPVO Guidelines on Article 63 CPVRR](#) on the meaning of ‘closely related species’.

When the goods applied for in Class 31 are so specific as to only cover the species protected by the PVD, including closely related species, a limitation cannot overcome an objection under [Article 7\(1\)\(m\) EUTMR](#) .

Example:

The EUTM applied for covers *peppers* in Class 31 and the sign consists of a PVD that protects species in the genus *Capsicum* (which includes all possible varieties of peppers). No limitation can be proposed, as excluding the genus *Capsicum* from *peppers* in Class 31 would leave nothing remaining in the list of goods applied for.

## 4.5 Relationship with other EUTMR provisions

Where a plant variety denomination is used in the market but has not been registered or published in the CPVO or at national level, [Article 7\(1\)\(c\) and \(d\) EUTMR](#) might be applicable.

***GUIDELINES FOR EXAMINATION OF  
EUROPEAN UNION TRADE MARKS***

***EUROPEAN UNION  
INTELLECTUAL PROPERTY OFFICE  
(EUIPO)***

***Part B***

***Examination***

***Section 4***

***Absolute grounds for refusal***

***Chapter 14 Acquired distinctiveness  
through use (Article 7(3) EUTMR)***

## Table of Contents

<b>1 Introduction.....</b>	<b>694</b>
<b>2 Requests.....</b>	<b>694</b>
<b>3 The Point in Time for which Acquired Distinctiveness has to be Established.....</b>	<b>695</b>
3.1 Examination proceedings.....	695
3.2 Cancellation proceedings.....	696
<b>4 Consumers.....</b>	<b>696</b>
<b>5 Goods and Services.....</b>	<b>697</b>
<b>6 Territorial Aspects.....</b>	<b>697</b>
6.1 Special provisions with respect to the accession of new Member States.....	698
6.2 Language area.....	698
6.3 Acquired distinctiveness throughout the EU.....	699
<b>7 Standard of Proof.....</b>	<b>701</b>
<b>8 Assessment of the Evidence.....</b>	<b>702</b>
8.1 Opinion polls and surveys.....	704
8.2 Market share, advertising and turnover.....	705
8.3 Declarations, affidavits and written statements.....	706
8.4 Prior registrations and acquired distinctiveness.....	707
8.5 Manner of use.....	707
8.6 Length of use.....	709
8.7 Post-filing-date evidence.....	710
<b>9 Consequences of Acquired Distinctiveness.....</b>	<b>710</b>

## 1 Introduction

According to [Article 7\(3\) EUTMR](#), a trade mark may still be registered despite the fact that it does not comply with [Article 7\(1\)\(b\), \(c\) or \(d\) EUTMR](#), provided that it 'has become distinctive in relation to the goods or services for which registration is requested in consequence of the use which has been made of it'.

[Article 7\(3\) EUTMR](#) constitutes an exception to the rule laid down in [Article 7\(1\)\(b\), \(c\) or \(d\) EUTMR](#) whereby registration must be refused for trade marks that are per se devoid of any distinctive character, for descriptive marks, and for marks that consist exclusively of indications that have become customary in the current language or in the bona fide and established practices of the trade.

Distinctive character acquired through use means that, although the sign lacks inherent distinctiveness *ab initio* with regard to the goods and services claimed, at least a significant proportion of the relevant public has, owing to the use made of it on the market, come to see it as identifying the goods and services claimed in the EUTM application as originating from a particular undertaking.<sup>(36)</sup> Thus, the sign has become capable of distinguishing those goods and services from those of other undertakings because they are perceived as originating from a particular undertaking. In this way, a sign originally unable to be registered under [Article 7\(1\)\(b\), \(c\) or \(d\) EUTMR](#) can acquire new significance, and its connotation, no longer purely descriptive or non-distinctive, allows it to overcome those absolute grounds for refusal of registration as a trade mark.

## 2 Requests

The Office will only examine acquired distinctive character following a request from the EUTM applicant. The Office is not bound to examine facts showing that the mark claimed has become distinctive through use within the meaning of [Article 7\(3\) EUTMR](#) unless the applicant has pleaded them (12/12/2002, [T-247/01](#), Ecoply, EU:T:2002:319, § 47).

According to [Article 2\(2\) EUTMR](#), the application may include a claim that the sign has acquired distinctive character through use within the meaning of [Article 7\(3\) EUTMR](#), as well as an indication of whether this claim is meant as a principal or subsidiary one. Such claim may also be made within the period referred to in [Article 42\(2\)](#), second sentence, EUTMR.

Therefore, as from 01/10/2017 and in accordance with [Article 2\(2\) EUTMR](#), the applicant can make the claim as a **principal** one (i.e. irrespective of the outcome on inherent distinctiveness), in which case the Office will take a single decision both on the

---

<sup>36</sup> The vast majority of cases that come before the Office relate to proof of use for individual marks. As such, this document usually makes reference to identifying the goods or services as 'originating from a particular undertaking'. Where appropriate, this should also be understood as covering the different essential functions of collective or certification marks *mutatis mutandis*.

mark's inherent distinctiveness and, where there is none, on the claim of acquired distinctiveness through use.

The second (new) option is to make the claim as a **subsidiary** one subject to a decision on inherent distinctiveness. In this case the Office will take **two** separate decisions at different points in time: first, one on the mark's inherent distinctiveness and then, once that decision (finding lack of inherent distinctiveness) has become final, another on the claim of acquired distinctiveness through use.

The claim must clearly and precisely identify what type it is.

As regards the timing of the request, both types of claim may be made:

- together with the application; or
- at the latest, in reply to the examiner's first objection.

Therefore, it will not be possible to raise the claim of acquired distinctiveness through use for the first time in appeal proceedings.

Where the applicant has validly made a **subsidiary claim**, the examiner will only decide on the **inherent distinctiveness** of the mark applied for and allow (in application of Article 66(2) EUTMR) this partial decision to be appealed in a separate appeal. Once that partial decision has become final, the examiner will resume the examination proceedings regarding the claim for acquired distinctiveness through use, specifying — with reference to the final findings on lack of inherent distinctiveness (public, territory, goods and services) — the time limit for submitting the corresponding evidence to substantiate that claim.

### **3 The Point in Time for which Acquired Distinctiveness has to be Established**

The evidence must prove that distinctiveness through use was acquired prior to the EUTM application's filing date. In the case of an IR, the relevant date is the date of registration by the International Bureau or, if the designation takes place at a later stage, the designation date. Where priority is claimed, the relevant date is the priority date. Hereafter, all these dates are referred to as the 'filing date'.

#### **3.1 Examination proceedings**

Since a trade mark enjoys protection as of its filing date, and since the filing date of the application for registration determines the priority of one mark over another, a trade mark must be registrable on that date. Consequently, the applicant must prove that distinctive character was acquired through use of the trade mark prior to the date of application for registration (11/06/2009, [C-542/07 P](#), Pure Digital, EU:C:2009:362, § 49, 51; 07/09/2006, [C-108/05](#), Europolis, EU:C:2006:530, § 22). Evidence of use made of the trade mark after this date should not be automatically disregarded, insofar as it may provide indicative information regarding the situation prior to the date of application (28/10/2009, [T-137/08](#), Green/Yellow, EU:T:2009:417, § 49).

### 3.2 Cancellation proceedings

In cancellation proceedings, a trade mark that was registered in breach of the provisions of [Article 7\(1\)\(b\), \(c\) or \(d\) EUTMR](#) may nevertheless no longer be declared invalid if, in consequence of the use that has been made of it, it has, **after registration**, acquired distinctive character for the goods or services for which it is registered ([Article 59\(2\) EUTMR](#)).

The precise purpose of this norm is to maintain the registration of those marks that, due to the use that has been made of them, have in the meantime — that is to say, after their registration and in any event before the application for an invalidity request — acquired distinctive character for the goods or services for which they were registered, in spite of the fact that, when registration took place, they were contrary to [Article 7 EUTMR](#) (14/12/2011, [T-237/10](#), Clasp lock, EU:T:2011:741, § 52-53, 86; 15/10/2008, [T-405/05](#), Manpower, EU:T:2008:442, § 127, 146; 10/12/2008 [T-365/06](#), BATEAUX MOUCHES, EU:T:2008:559, § 37-38).

## 4 Consumers

Distinctive character of a sign, including that acquired through use, must be assessed in relation to the perception of the average consumer for the category of goods or services in question. These consumers are deemed to be reasonably well informed, and reasonably observant and circumspect. The definition of the relevant public is linked to an examination of the intended purchasers of the goods or services concerned, since it is in relation to those purchasers that the mark must perform its essential function.

Consequently, such a definition must be arrived at by reference to the essential function of a trade mark (24/09/2019, [T-13/18](#), Crédit Mutuel, EU:T:2019:673, § 142):

- for individual marks, this is to guarantee the identity of the origin of the goods or services covered by the mark to consumers or end users by enabling them, without any possibility of confusion, to distinguish the goods or services from others of another origin (29/09/2010, [T-378/07](#), Représentation d'un tracteur en rouge, noir et gris, EU:T:2010:413, § 33, 38);
- for collective marks, the essential function is to distinguish the goods and services of the members of the association that is the proprietor of the mark from those of other undertakings (20/09/2017, [C-673/15 P](#) & [C-674/15 P](#) & [C-675/15 P](#) & [C-676/15 P](#), DARJEELING (fig.) / DARJEELING et al., EU:C:2017:702, § 63);
- for certification marks, the essential function is to distinguish goods or services which are certified by the proprietor of the mark from goods and services which are not so certified.

The relevant consumer includes, therefore, not only persons who have actually purchased the goods and services but also any potentially interested person in the

strict sense of prospective purchasers (29/09/2010, [T-378/07](#), *Représentation d'un tracteur en rouge, noir et gris*, EU:T:2010:413, § 41 et seq.).

Who prospective purchasers are is defined depending on the precise product or service for which registration is sought. If the claimed goods or services represent a broad category (for example, bags or watches), it is irrelevant that the actual products offered under the sign are extremely expensive luxury items — the public will include all the prospective purchasers for the goods claimed in the EUTM application, including non-luxury and cheaper items if the claim is for a broad category.

## 5 Goods and Services

Since the main function of a trade mark is to guarantee the origin of goods and services, acquired distinctiveness must be assessed in respect of the goods and services at issue. Consequently, the applicant's evidence must prove a link between the sign and the goods and services for which the sign is applied for, establishing that the relevant class of persons, or at least a significant proportion thereof, identify the goods and services as originating from a particular undertaking because of the trade mark (04/05/1999, [C-108/97](#) & [C-109/97](#), *Chiemsee*, EU:C:1999:230, § 52; 19/05/2009, [T-211/06](#), *Cybercrédit et al.*, EU:T:2009:160, § 51).

## 6 Territorial Aspects

Pursuant to [Article 1 EUTMR](#), a European Union trade mark has a unitary character and has equal effect throughout the European Union (EU). Accordingly, a mark must be refused registration even if it is devoid of distinctive character only in part of the EU. That part of the EU may be comprised of a single Member State (22/06/2006, [C-25/05 P](#), *Bonbonverpackung*, EU:C:2006:422, § 81-83; 29/09/2010, [T-378/07](#), *Représentation d'un tracteur en rouge, noir et gris*, EU:T:2010:413 § 45 and the case-law cited).

As a logical consequence, acquired distinctiveness must be established throughout the territory in which the trade mark did not *ab initio* have distinctive character (22/06/2006, [C-25/05 P](#), *Bonbonverpackung*, EU:C:2006:422, § 83, 86; 29/09/2010, [T-378/07](#), *Représentation d'un tracteur en rouge, noir et gris*, EU:T:2010:413, § 30).

This may prove difficult and burdensome for the applicant, particularly with regard to three-dimensional or colour marks, where consumer perception of a potential lack of inherent distinctiveness will most likely be the same in each and every Member State of the EU. In this respect, the Court has held that, despite the fact that acquired distinctiveness must be shown **throughout the EU**, it would be **unreasonable** to require proof of acquired distinctiveness for **each individual Member State** (24/05/2012, [C-98/11 P](#), *Hase*, EU:C:2012:307, § 62).

The question arises whether the Office can decide whether the evidence submitted to establish that a particular sign has acquired distinctive character through use is



relevant for several Member States or even for the whole of the EU (see [paragraph 6.3](#) below).

Evidence of acquired distinctiveness must be **examined as a whole**, taking into account, in particular, the market share held by the trade mark, and the intensity, frequency and duration of use of the mark (see [paragraph 8](#) below). The evidence must establish that a significant proportion of the relevant public is able, by virtue of that mark, to identify the goods or services concerned as originating from a particular undertaking. Evidence from non-EU states is irrelevant, except insofar as it might enable conclusions to be drawn about use within the EU (24/06/2014, [T-273/12](#), Ab in den Urlaub, EU:T:2014:568, § 45).

## 6.1 Special provisions with respect to the accession of new Member States

In accordance with the provisions of the EU accession treaties, an EUTM applied for before the date of accession of a given Member State may only be rejected for reasons that already existed before the date of accession. Hence, in the Office's examination proceedings, acquired distinctiveness must be demonstrated only with respect to Member States of the EU at the time of the EUTM application, and not those that have joined the EU subsequently.

## 6.2 Language area

Acquired distinctiveness through use must be shown with respect to all Member States/territories where the objection applies (see the Guidelines, [Part B, Examination, Section 4, Absolute grounds for refusal, Chapter 14, Acquired distinctiveness through use \(Article 7\(3\) EUTMR\), paragraph 6.3](#)).

When a mark is objected to because of its verbal element(s), the objection will always state the meaning of that word in the specific language on which the objection is based.

In these cases, the relevant territory for filing evidence of acquired distinctiveness through use can be:

- a) the Member State(s)/territories mentioned in the objection; or
- b) the Member State(s) where the language at stake in the objection is official; or
- c) a territory broader than those under a) and b).

When an EU national language is official in more than one Member State, acquired distinctiveness through use must be proven for each of the Member States in which that language is official.

EU national languages	Official in the following Member States
-----------------------	---

Dutch	Belgium and Netherlands
English	Ireland and Malta
French	Belgium, France and Luxembourg
German	Belgium, Germany, Luxembourg and Austria
Greek	Greece and Cyprus
Swedish	Finland and Sweden

Situation c) above would normally happen where:

- the verbal element of the mark is a basic English term, and the mark is objected to in relation to the English-speaking part of the relevant consumers (in this case, the territory where acquired distinctiveness must be proved is not limited to the Member State(s) where English is the official language);
- the verbal element of the mark is a term in a non-EU language and the mark is objected to based on a specific territory that is not necessarily the only one (in this case, the territory where acquired distinctiveness must be proved is not limited to the Member State(s) mentioned in the objection).

When a ground for refusal applies in territories outside the Member State(s) in which the language giving rise to the objection is an official language and the applicant was not informed of the territories, the Office will not refuse the application because evidence of acquired distinctiveness is lacking for these territories. In these cases, the Office will inform the applicant of the relevant territories and give them an opportunity to file the required evidence.

For further explanations about the languages and relevant parts of the EU, see the Guidelines, [Part B, Examination, Section 4, Absolute grounds for refusal, Chapter 1, General principles, paragraph 4](#).

### 6.3 Acquired distinctiveness throughout the EU

The acquisition of distinctive character through use must be proven for the part of the EU in which the trade mark concerned did not **initially** have this character.

This may prove difficult and burdensome for the applicant, particularly when the objection exists throughout the EU. This is normally the case for colour marks, shape marks consisting exclusively of the shape of the products themselves and purely figurative trade marks when they are found to be devoid of distinctive character, as it may be assumed that the assessment of their distinctiveness will be the same throughout the EU, unless there is concrete evidence to the contrary (24/02/2016, [T-411/14](#), Shape of a bottle (3D), EU:T:2016:94, § 68).

The Court has pointed out that, where distinctiveness acquired through use has to be proved throughout the EU, it is not sufficient to prove it merely in a significant part of the EU (25/07/2018, [C-84/17 P](#), [C-85/17 P](#) & [C-95/17 P](#), SHAPE OF A 4-FINGER CHOCOLATE BAR (3D), EU:C:2018:596, § 78).

The Court has also held that, under these circumstances, it would be unreasonable to require proof of acquired distinctiveness for each individual Member State (24/05/2012, [C-98/11 P](#), Hase, EU:C:2012:307, § 62).

Furthermore, no provision in the EUTMR requires that the acquisition of distinctive character through use be established by separate evidence in each Member State. Therefore, it is possible that the evidence filed to establish that a particular sign has acquired distinctive character through use is relevant for several Member States or even for the whole of the EU (25/07/2018, [C-84/17 P](#), [C-85/17 P](#) & [C-95/17 P](#), SHAPE OF A 4-FINGER CHOCOLATE BAR (3D), EU:C:2018:596, § 80-83).

Two scenarios can be identified in this regard.

1. Regionalisation (division of the EU market into regional segments)

As the Court has confirmed, this may be the case:

- a. where, for certain goods or services, the economic operators have grouped several Member States together in the same distribution network and have treated them, especially for marketing strategy purposes, as if they were one and the same market;
- b. when, due to the geographical, cultural or linguistic proximity between two Member States, the relevant public in one of them has sufficient knowledge of the goods and services that are present on the national market of the other.

Therefore, where cross-border markets are sufficiently homogeneous, global evidence of distinctiveness acquired through use within such a cross-border market is likely to be relevant for all the Member States concerned, even if it contains little or no information for each Member State individually.

It follows that, although it is not necessary for the evidence of acquisition of distinctive character through use to be submitted for each individual Member State, this evidence must be capable of establishing the acquisition of distinctive character through use throughout the relevant territory (25/07/2018, [C-84/17 P](#), [C-85/17 P](#) & [C-95/17 P](#), SHAPE OF A 4-FINGER CHOCOLATE BAR (3D), EU:C:2018:596, § 83).

2. Extrapolation

Even where national markets cannot be grouped together or treated in a uniform manner, the conclusions on the acquisition of distinctive character reached on the basis of evidence concerning the territory of one or more Member States could be assumed to be applicable to other Member States too, if at least some evidence of use has been submitted regarding the latter, and if there are elements that allow this extrapolation — which would again require that the conditions in the respective markets are, if not the same, at least quite similar.

In that regard, the Court has held that evidence of acquired distinctiveness for the ‘combination of the colours green and yellow’ throughout the EU was acceptable

despite a lack of turnover figures for two Member States, since it is not necessary to provide the same types of evidence for each and every Member State, considering also that the various items of evidence can be mutually corroborative (28/10/2009, [T-137/08](#), Green/Yellow, EU:T:2009:417, § 33-42 et seq.).

**In conclusion**, for both regionalisation and extrapolation to be successfully relied on, it is essential that the EUTM applicant convincingly explains the relevance of the evidence for another Member State, for several Member States or for the whole of the EU, as the case may be.

For example, if surveys covering only some Member States have been submitted, the applicant will have to demonstrate that their results are also significant for other comparable national markets, either because of the similar marketing strategies applied or because of geographical, cultural or linguistic proximity (see, by analogy, 24/02/2016, [T-411/14](#), Shape of a bottle (3D), EU:T:2016:94, § 80).

The mere production of market surveys from five Member States, coupled with turnover figures, as well as marketing and advertising expenses collected Member State by Member State, could not establish the existence of one or more transnational markets made up of different Member States. Furthermore, the results of the surveys could neither be extrapolated to all the Member States, nor be completed and supported in the Member States that were not covered by those surveys (19/06/2019, [T-307/17](#), DEVICE OF THREE PARALLEL STRIPES (fig.), EU:T:2019:427, § 155-157).

Similarly, market surveys in only eight Member States were found insufficient to prove that the relevant public in the EU attributed a unique commercial origin to a V-shaped guitar (28/06/2019, [T-340/18](#), SHAPE OF A FLYING V GUITAR (3D), EU:T:2019:455, § 67-68).

## 7 Standard of Proof

The requirements to prove acquired distinctiveness through use pursuant to [Article 7\(3\) EUTMR](#) are not the same as those to prove genuine use pursuant to [Article 47\(2\) EUTMR](#). Whilst under [Article 7\(3\) EUTMR](#) it is necessary to prove qualified use, such that the relevant public perceives as distinctive a sign that per se is devoid of distinctive character, the reason behind the proof of genuine use is completely different, namely to restrict the number of trade marks registered and protected, and consequently the number of conflicts between them.

Furthermore, the Court has held that the case-law relating to [Article 7\(3\) EUTMR](#) must not be confused with the case-law relating to the acquisition of reputation (which must be proven in a substantial part of the EU but not in every Member State). The applicant must prove the acquisition of distinctive character through use in the part of the EU in which the contested mark was devoid of any distinctive character. The case-law related to [Article 7\(3\) EUTMR](#), therefore, must not be confused with the test on acquisition of reputation (21/04/2015, [T-359/12](#), Device of a checked pattern (maroon & beige), EU:T:2015:215, § 119-120 and case-law quoted therein).

Therefore, the EUTM applicant must submit evidence that enables the Office to find that at least a significant proportion of the relevant section of the public identifies the products or services concerned as originating from a particular undertaking because of the trade mark (15/12/2015, [T-262/04](#), Briquet à Pierre, EU:T:2005:463, § 61 and the case-law cited therein).

The evidence must be clear and convincing. The EUTM applicant must clearly establish all the facts necessary to safely conclude that the mark is recognised by the relevant public as a badge of origin, that is to say, that it has created a link in the mind of the relevant public with the goods or services provided by a specific company, despite the fact that, in the absence of such use, the sign at issue would lack the necessary distinctiveness to create such a link.

For example, the combination of the colours green and yellow was found to have acquired distinctiveness through use because it was proven that in the perception of a significant part of the relevant public it referred to the machines manufactured by a certain company. The means of evidence were a number of statements from professional associations according to which the combination of colours referred to agricultural machines manufactured by that company and the fact that the company had been using the same combination of colours on its machines consistently in the EU for a considerable time prior to 1996 (28/10/2009, [T-137/08](#), Green/Yellow, EU:T:2009:417, § 36-37).

Furthermore, acquired distinctiveness must be the result of the use of the mark as a trade mark, not as purely functional packaging (25/09/2014, [T-474/12](#), Shape of goblets (3D), EU:T:2014:813, § 56-58 and the case-law cited therein) or as a descriptive indication on packaging. For example, use of the sign 'Giffjar' (which indicates a kind of bread in Swedish) on the packaging of pastries, together with descriptive indications of flavours, is made in a descriptive context, not as a badge of origin (09/07/2014, [T-520/12](#), Giffjar, EU:T:2014:620, § 44-45).

For a finding of acquired distinctiveness through use, the case-law does not prescribe fixed percentages of market penetration or of recognition by the relevant public (19/06/2014, [C-217/13](#) & [C-218/13](#), Oberbank e.a., EU:C:2014:2012, § 48). Rather than using a fixed percentage of the relevant public in a given market, the evidence should show that a significant proportion of the public perceives the mark as identifying specific goods or services as originating from a particular undertaking.

The evidence must relate to each of the goods and services claimed in the EUTM application. After an initial absolute grounds objection under [Article 7\(1\)\(b\), \(c\) or \(d\) EUTMR](#), only the goods and services claimed for which acquired distinctiveness through use has been proven may proceed to registration.

## 8 Assessment of the Evidence

In establishing acquired distinctiveness, account may be taken of, inter alia, the following **factors**:

- the market share held by the mark with regard to the relevant goods or services;
- how intensive, geographically widespread and long-standing use of the mark has been;
- the amount invested by the undertaking in promoting the mark for the relevant goods or services;
- the proportion of the relevant public who, because of the mark, identifies the goods or services as originating from a particular undertaking.

See judgments of 04/05/1999, [C-108/97](#) & [C-109/97](#), Chiemsee, EU:C:1999:230, § 31; 29/09/2010, [T-378/07](#), Représentation d'un tracteur en rouge, noir et gris, EU:T:2010:413, § 32.

[Article 97 EUTMR](#) contains a non-exhaustive list of **means of giving or obtaining evidence** in proceedings before the Office, which may serve as guidance to applicants. Examples of evidence that may help to show acquired distinctiveness include, inter alia:

- sales brochures
- catalogues
- price lists
- invoices
- annual reports
- turnover figures
- advertising investment figures and reports
- advertisements (press cuttings, billboard posters, TV adverts), together with evidence of their intensity and reach
- customer and/or market surveys
- affidavits.

For further details on means of evidence, see by analogy the Guidelines, [Part C, Opposition, Section 5, Trade Marks with Reputation \(Article 8\(5\) EUTMR\), paragraph 3.1.4.4.](#)

As regards the structure and format in which written evidence must be submitted, Article 55 EUTMDR applies. For further details regarding annexes to communications to the Office, please see the Guidelines, [Part A, General Rules, Section 1, Means of communication, Time limits, paragraph 3.1.3.](#)

The basic rules on the **evaluation of evidence** are also applicable here. The Office must make an **overall assessment of all the evidence** submitted (04/05/1999, [C-108/97](#) & [C-109/97](#), Chiemsee, EU:C:1999:230, § 49), weighing up each indication against the others.

Applicants should take great care to make sure not only that the evidence shows use of the **mark applied for** but also that it is sufficient to identify the **dates** of such use and the specific **geographical** territory of use within the EU. Evidence that cannot be related to a certain point in time will normally be insufficient to show that distinctiveness had been acquired before the filing date, and evidence of use outside the EU cannot show the required market recognition of the relevant public within the EU. Furthermore, evidence that mixes material relating to the EU with that relating to non-EU territories,



and does not permit the Office to identify the specific extent of EU-only use, will be similarly devoid of probative value for the relevant EU public.

The Court has declared that direct evidence such as declarations by professional associations and market studies are usually the most relevant means for proving acquired distinctiveness through use. Invoices, advertising expenditure, magazines and catalogues may help to corroborate such direct evidence (29/01/2013, [T-25/11](#), Cortadora de cerámica, EU:T:2013:40, § 74).

In order to assess the evidential value of a document, regard should be had to its **credibility**. It is also necessary to take into account the person from whom the document originates, the circumstances in which it came into being, the person to whom it was addressed and whether, superficially, the document appears sound and reliable (07/06/2005, [T-303/03](#), Salvita, EU:T:2005:200, § 42; 16/12/2008, [T-86/07](#), Deitech, EU:T:2008:577, § 46 et seq.).

## 8.1 Opinion polls and surveys

Opinion polls concerning the proportion of the relevant public that recognises the sign as indicating the commercial origin of the goods or services can, if conducted properly, constitute one of the most direct kinds of evidence, since they can show the actual perception of the relevant public. However, it is not an easy matter to correctly formulate and implement an opinion poll so that it can be seen to **be truly neutral and representative**. Leading questions, unrepresentative samples of the public, and undue editing of responses should be avoided, as these can undermine the probative value of such surveys.

Accordingly, any opinion poll evidence must be assessed carefully. It is important that the questions asked are not leading ones (13/09/2012, [T-72/11](#), Espetec, EU:T:2012:424, § 79). The criteria for selecting the public interviewed must be assessed carefully. The sample must be indicative of the entire relevant public and must be selected randomly (29/01/2013, [T-25/11](#), Cortadora de cerámica, EU:T:2013:40, § 88).

The Court does not exclude that a survey compiled some time before or after the filing date could contain useful indications, although it is clear that its evidential value is likely to vary depending on whether the period covered is close to or distant from the filing date or priority date of the trade mark application at issue. Furthermore, its evidential value depends on the survey method used (12/07/2006, [T-277/04](#), Vitacoat, EU:T:2006:202, § 38-39).

However, the Court of Justice has made it clear that the results of a consumer survey cannot be the only decisive criterion in support of the conclusion that distinctive character has been acquired through use (19/06/2014, [C-217/13](#) & [C-218/13](#), Oberbank e.a., EU:C:2014:2012, § 48). They must therefore be complemented by other means of evidence.

For further details on the assessment of opinion polls, see the Guidelines, [Part C, Opposition, Section 5, Trade Marks with Reputation \(Article 8\(5\) EUTMR\), paragraph 3.1.4.4.](#)

## 8.2 Market share, advertising and turnover

The **market share** held by the trade mark in relation to the goods and/or services applied for may be relevant for assessing whether that mark has acquired distinctive character through use, since such market penetration might enable the Office to infer that the relevant public would recognise the mark as identifying the goods or services as originating from a specific undertaking, and thus distinguish them from the goods and services of other undertakings.

The **investment** in advertising or promoting the mark in the relevant market for the goods or services claimed may also be relevant for assessing whether the mark has acquired distinctive character through use (22/06/2006, [C-25/05 P](#), Bonbonverpackung, EU:C:2006:422, § 76 et seq.). However, many attempts to prove distinctiveness acquired through use fail because the evidence provided by the applicant is not sufficient to prove a link between the market share and advertising, on the one hand, and consumer perceptions on the other.

Information concerning **turnover** and advertising expenses is one of the most readily available forms of evidence. These figures can have a significant impact on the assessment of the evidence, but in the great majority of cases are not sufficient alone to prove acquired distinctiveness of a trade mark through use. This is because turnover/advertising costs alone, without additional corroborative details, are frequently too general to allow specific conclusions to be drawn about the use of one particular trade mark. It is thus necessary to identify precisely the turnover/advertising figures and evidence relating to the mark applied for, as well as their link to the relevant goods and services. Furthermore, it is desirable that the figures be segregated on an annual and market-by-market basis. The evidence should show the specific period(s) of use (including details of when use commenced), so that the Office is able to establish whether the evidence proves that the trade mark acquired distinctiveness before the filing date.

Goods and services are often marketed under several trade marks, which makes it difficult to see the relevant customer's perception of the EUTM applied for on its own, that is to say, without such perception being affected by the other marks present. Turnover and advertising figures can often include sales or promotion of other trade marks, or of significantly different forms of the trade mark at issue (for example, figurative trade marks rather than word marks, or differing word elements in a figurative mark), or are too general to allow identification of the specific markets under consideration. As a consequence, broadly consolidated turnover or advertising figures may not be sufficient to prove whether the relevant public perceives the trade mark at issue as a badge of origin or not.



For further details on the assessment of market share, advertising and turnover, see the Guidelines, [Part C, Opposition, Section 5, Trade Marks with Reputation \(Article 8\(5\) EUTMR\), paragraph 3.1.4.4.](#)

### 8.3 Declarations, affidavits and written statements

Pursuant to [Article 97\(1\)\(f\) EUTMR](#), ‘statements in writing, sworn or affirmed or having a similar effect under the law of the State in which [they are] drawn up’ are valid means of evidence. With regard to **admissibility**, only in cases where the statements have not been sworn or affirmed is it necessary to consider the rules of law of the national jurisdiction as to the effects of a written statement (07/06/2005, [T-303/03](#), *Salvita*, EU:T:2005:200, § 40). In case of doubt as to whether a statement has been sworn or affirmed, it is up to the applicant to submit evidence in this regard.

The weight and **probative value** of statutory declarations is determined by the general rules applied by the Office to the assessment of such evidence. In particular, both the capacity of the person giving the evidence and the relevance of the contents of the statement to the particular case must be taken into account.

Statements from **independent trade associations, consumer organisations and competitors** are an important means of evidence insofar as they come from independent sources. However, they must be examined carefully, as they might not be enough to prove distinctiveness acquired through use if, for example, they refer to ‘the trade marks of the applicant’ instead of to the specific mark in question (13/09/2012, [T-72/11](#), *Espetec*, EU:T:2012:424, § 83-84).

Evidence from **suppliers or distributors** should, generally, be given less weight, since it is less likely that their evidence will be from an independent perspective. In this regard, the degree of independence of the latter will influence the weight to be given to the evidence by the Office (28/10/2009, [T-137/08](#), *Green/Yellow*, EU:T:2009:417, § 54-56).

Insofar as a declaration is **not made by an independent third party**, but by a person connected to the applicant through an employment relationship, it cannot in itself constitute sufficient evidence that the mark applied for has acquired distinctive character through use. In consequence, it must be treated as merely indicative and needs to be corroborated by other evidence (21/11/2012, [T-338/11](#), *PHOTOS.COM*, EU:T:2012:614, § 51)

As regards **statements from chambers of commerce and industry or other trade and professional associations and certifications and awards**, the Court has noted that such statements and certifications must identify precisely the trade mark applied for (13/09/2012, [T-72/11](#), *Espetec*, EU:T:2012:424, § 82 et seq.).

However, **cease and desist letters** against competitors or letters to newspapers complaining against the use of the sign in a generic sense have been considered evidence against acquired distinctiveness (21/05/2014, [T-553/12](#), *BATEAUX MOUCHES*, EU:T:2014:264, § 66)

For further details on the assessment of means of evidence, see the Guidelines, [Part C, Opposition, Section 5, Trade Marks with Reputation \(Article 8\(5\) EUTMR\), paragraph 3.1.4.4.](#)

## 8.4 Prior registrations and acquired distinctiveness





For evidence that consists of or includes Member State registrations **obtained on the basis of acquired distinctiveness**, the date to which the evidence submitted at national level refers will usually be different from the filing date of the EUTM application. These registrations are not binding, but may be taken into account, provided that the Office is able to assess the evidence submitted to the national IP office in question.

The applicant may also refer to **prior national registrations** where no acquired distinctiveness is claimed. Nevertheless, it is established case-law that such registrations do not bind the Office. Moreover, the Office is not bound by its previous decisions and such cases must be assessed on their own merits (21/05/2014, [T-553/12](#), BATEAUX MOUCHES, EU:T:2014:264, § 72-73).

## 8.5 Manner of use

Acquired distinctiveness must be demonstrated with respect to the sign applied for. The evidence should show examples of how the trade mark is actually used (brochures, packaging, samples of the goods, etc.). The concept of use of a trade mark, within the meaning of [Article 7\(3\) EUTMR](#) must be interpreted as referring not only to use of the mark in the form in which it was submitted for registration, but also to the use of the trade mark in forms which differ from that form solely by insignificant variations and that are able, therefore, to be regarded as broadly equivalent to that form (19/06/2019, [T-307/17](#), DEVICE OF THREE PARALLEL STRIPES (fig.), EU:T:2019:427, § 62).

Where a trade mark is extremely simple, even minor alterations to that mark may constitute significant changes, so that the amended form may not be regarded as broadly equivalent to the mark as registered. Indeed, the simpler the mark, the less likely it is to have distinctive character and the more likely it is for an alteration to that mark to affect one of its essential characteristics and the perception of that mark by the relevant public (19/06/2019, [T-307/17](#), DEVICE OF THREE PARALLEL STRIPES (fig.), EU:T:2019:427, § 72).

	<p>'... reversing the colour scheme, even if a sharp contrast between the three stripes and the background is preserved, cannot be described as an insignificant variation compared to the registered form of the mark at issue' § 77.</p>		
			
EUTM No 12 442 166	Examples of the sign reflected in some of the evidence of use		

It is possible to prove acquired distinctiveness of a sign that **has been used together with other trade marks** (28/10/2009, [T-137/08](#), Green/Yellow, EU:T:2009:417, § 27), provided that the relevant consumer attributes to the sign in question the function of identification (07/07/2005, [C-353/03](#), Have a break, EU:C:2005:432; 30/09/2009, [T-75/08](#), EU:T:2009:374, § 43; 28/10/2009, [T-137/08](#), Green/Yellow, EU:T:2009:417, § 46).

The Court further ruled that, although the trade mark for which registration is sought may have been used as part of a registered trade mark or in conjunction with such a mark, the fact remains that, for the purposes of registration of the mark itself, the trade mark applicant must prove that that mark alone, as opposed to any other trade mark that may also be present, identifies the particular undertaking from which the goods originate (16/09/2015, [C-215/14](#), Nestlé KIT KAT, EU:C:2015:604, § 66; 24/02/2016, [T-411/14](#), Shape of a bottle (3D), EU:T:2016:94, § 76; 16/03/2016, [T-363/15](#), LAATIKON MUOTO (3D), EU:T:2016:149, § 51).

Moreover, the Court has held on numerous occasions that **advertising material** on which a sign that is devoid of any distinctive character always appears with other marks that, by contrast, do have distinctive character does not constitute proof that the public perceives the sign applied for as a mark that indicates the commercial origin of the goods. For instance, the Court considered that the use of the sign 'Gifflar' (which indicates a kind of bread in Swedish) on the packaging of pastries, together with the trade mark Pågen, was made in a descriptive context, not as a badge of origin (09/07/2014, [T-520/12](#), Gifflar, EU:T:2014:620, § 44-45).

## 8.6 Length of use

The evidence should indicate when use commenced and should also show that the use was continuous or indicate reasons if there are gaps in the period of use.

As a general rule, long-standing use is likely to be an important persuasive element in establishing acquired distinctiveness. The longer customers and potential customers have been exposed to a mark the more likely they are to have made the connection between that mark and a single source in trade.

Considering, however, that length of use is only one of the factors to be taken into account, there may be situations where exceptions to the above rule are justified, in particular when other factors may also come into play that are capable of making up for a short length of use. For example, where products or services are the subject of a major advertising launch and/or the sign applied for is a mere variant of a sign already in long use, it may be the case that acquired distinctiveness can be achieved quite quickly.

This could be the case, for instance, where a new version of an existing and widely used computer-operating system is launched under a sign that essentially reproduces the structure and/or contents of the trade mark applied to previous versions of the product. The trade mark for such a product would be capable of achieving widespread acquired distinctiveness within a fairly short period of time simply because all existing users will immediately be made aware that the sign applied for refers to the upgrading to the new version.

In the same vein, it is in the nature of certain major sporting, musical or cultural events that they take place at regular intervals and are known to have extremely wide appeal. These major events are anticipated by millions, and the knowledge that the event is due on a particular date precedes the formal announcement of where it will take place. This circumstance creates intense interest in the nominated location of such events and in the announcement thereof ('city/country+year' marks). It is therefore reasonable to suppose that the moment a particular event, tournament or games is announced as having been allocated to a particular city or country, it is likely to become known instantly to practically all relevant consumers with an interest in the sector concerned or to professionals in the sector. This may thereby give rise to the possibility of very rapid acquired distinctiveness of a mark concerning a forthcoming event, in particular where the sign reproduces the structure of previously used trade marks with the result that the public immediately perceives the new event as a sequel to a series of well-established events.

The assessment of such rapid acquired distinctiveness will follow the general criteria regarding, for instance, extent of use, territory, relevant date or targeted public, as well as regarding the onus on the applicant to provide evidence thereof. The only particularity refers to length of use and the possibility that, under certain circumstances, the acquisition of acquired distinctiveness may occur very rapidly, or even instantaneously. As under any other claim for acquired distinctiveness, it is for the

applicant to demonstrate that the public is able to perceive the trade mark in question as a distinctive sign.

## 8.7 Post-filing-date evidence

The evidence must show that, prior to the filing date, the trade mark had acquired distinctive character through use.

However, this does not preclude the possibility that account may be taken of evidence that, although subsequent to the filing date, enables conclusions to be drawn regarding the situation as it was on the filing date (19/06/2014, [C-217/13](#), Oberbank e.a., EU:C:2014:2012, § 60). Therefore, evidence cannot be rejected merely because it post-dates the filing date. Accordingly, such evidence must be assessed and given due weight.

As an example, a trade mark that enjoys particularly relevant recognition on the market or a substantially relevant market share a few months after the filing date may have had acquired distinctiveness also on the filing date.

## 9 Consequences of Acquired Distinctiveness

A trade mark registered in accordance with [Article 7\(3\) EUTMR](#) enjoys the same protection as any other trade mark that was found inherently registrable upon examination.

If the EUTM application is accepted based on [Article 7\(3\) EUTMR](#), this information is published in the EUTM Bulletin, using INID code 521.

***GUIDELINES FOR EXAMINATION OF  
EUROPEAN UNION TRADE MARKS***

***EUROPEAN UNION  
INTELLECTUAL PROPERTY OFFICE  
(EUIPO)***

***Part B***

***Examination***

***Section 4***

***Absolute grounds for refusal***

***Chapter 15 European Union collective marks***

## Table of Contents

<b>1 Character of Collective Marks.....</b>	<b>713</b>
1.1 Definition.....	713
1.2 Specific function.....	713
1.3 Relationship with individual and certification marks.....	714
1.4 Applicable provisions and examination.....	714
<b>2 Ownership.....</b>	<b>715</b>
<b>3 Specific Absolute Grounds of Refusal.....</b>	<b>716</b>
3.1 Misleading as to the character or meaning of the mark.....	716
3.2 Regulations governing use.....	717
3.2.1 Compliance with public policy and morality.....	717
3.2.2 Remedies.....	718
<b>4 Specificities as Regards Examination of the General Absolute Grounds for Refusal.....</b>	<b>718</b>
4.1 Article 74(2) EUTMR: ‘geographical derogation’.....	718
4.2 Objections raised under Article 7(1)(j), (k) or (l) EUTMR.....	719

# 1 Character of Collective Marks

## 1.1 Definition

A European Union collective mark (EU collective mark) is a specific kind of EUTM that, pursuant to [Article 74\(1\) EUTMR](#), 'is described as such when the mark is applied for and is capable of distinguishing the goods or services of the members of the association which is the proprietor of the mark from those of other undertakings'.

It is one of the three kinds of marks set out in the Regulation, along with individual marks and certification marks.

## 1.2 Specific function

An **EU collective mark's essential function** is to distinguish the goods and services of the members of the association that owns the mark from those of other companies that do not belong to that association (20/09/2017, [C-673/15 P & C-674/15 P & C-675/15 P & C-676/15 P](#), DARJEELING (fig.) / DARJEELING et al., EU:C:2017:702, § 63; 12/12/2019, [C-143/19 P](#), EIN KREIS MIT ZWEI PFEILEN (fig.), EU:C:2019:1076, § 26, 57, 58). Therefore, the EU collective mark indicates the commercial origin of certain goods and services by informing the consumer that the producer of the goods or the service provider belongs to a certain association and has the right to use the mark.

Even **geographically descriptive EU collective marks** ([Article 74\(2\) EUTMR](#)) must be capable of fulfilling the essential function of a collective mark to indicate the collective commercial origin of the goods sold under that trade mark (20/09/2017, [C-673/15 P & C-674/15 P & C-675/15 P & C-676/15 P](#), DARJEELING collection de lingerie (fig.) / DARJEELING et al., EU:C:2017:702, § 54 et seq; 05/03/2020, [C-766/18 P](#), BBQLOUMI (fig.) / HALLOUMI, EU:C:2020:170, § 74).

An **EU collective mark is typically used** by companies, together with their **own individual marks**, to indicate that they are members of a certain association (12/12/2019, [C-143/19 P](#), EIN KREIS MIT ZWEI PFEILEN (fig.), EU:C:2019:1076, § 54).

For example, Spain's Association of Shoe Manufacturers may want to apply for the collective mark 'Asociación Española de Fabricantes de Calzado', which, while belonging to the association, is also going to be used by all its members, who might be competitors. A member of the association may want to use the collective mark in addition to its own individual mark, which could be, for example, 'Calzados Luis'.



### 1.3 Relationship with individual and certification marks

It is up to the applicant to decide whether the trade mark fulfils the requirements of a collective mark, as opposed to those of an individual mark or certification mark within the meaning of [Article 83 EUMTR](#). This means that, in principle, the same sign applied for as an EU collective mark might also be applied for as an individual EUTM or EU certification mark, provided that the respective conditions of the EUTMR are met for each application. The three kinds of marks do not differ necessarily with respect to the signs per se but as regards other characteristics specific to each one of them, including, in particular, the requirements of ownership and the conditions of use of the mark.

However, an applicant should be aware of the fact that, in the event of having to subsequently demonstrate genuine use of the marks, it will probably be rather difficult to show use of the same sign for different kinds of marks. For further information regarding genuine use of a mark in accordance with its function, please see the [Guidelines, Part C, Opposition, Section 7, Proof of Use](#), paragraph 2.3.1.

For example, an association can file an application for the word mark ‘Tamaki’ either as an individual mark, a certification mark or a collective mark, depending on the mark’s intended use (by the association itself or its members, or as a sign of guarantee of a characteristic or not). If it is applied for as an EU collective mark, certain additional formalities must be met, such as the submission of regulations governing use (see the Guidelines, [Part B, Examination, Section 2, Formalities, paragraph 8.2](#)).

After filing the application, changes to the kind of mark (between collective, certification and individual marks) are accepted only when it is obvious from the application that the wrong kind of mark has been selected (see the Guidelines, [Part B, Examination, Section 2, Formalities, paragraph 8.4](#)).

### 1.4 Applicable provisions and examination

The EUTMR provisions apply to EU collective marks, unless Articles [75](#) to [82](#) EUTMR provide otherwise. On the one hand, EU collective marks are therefore subject to the general EUTM regime and on the other hand, to some exceptions and particularities.

It follows, firstly, that an application for an EU collective mark is, in principle, subject to the same examination procedure and conditions as an application for an individual mark. In general terms, the classification of goods and services, and the examination of formalities and of absolute grounds for refusal, follow the same procedure as that applied to individual trade marks.

For example, examiners will check the list of goods and services or the language requirements in the same way as they do with individual trade marks. Similarly, if the EU collective mark falls under one of the grounds for refusal of [Article 7 EUTMR](#), this will also be examined.

Pursuant to the new provision of [Article 16 EUTMIR](#) , the regulations submitted by the applicant governing the use of its EU collective mark **must cover its use for all the goods and services** included in the list of the EU collective mark application. For EU collective marks conflicting with geographical indications (GIs), traditional terms for wine or traditional specialities guaranteed, the regulations governing the use of an EU collective mark should accurately reflect any limitation introduced to overcome such conflicts. For example, the regulations governing use of an EU collective mark in conflict with the 'XYZ' GI for *wines* should accurately reflect the fact that they refer to the use of the trade mark for 'XYZ' (GI) *wines* . For more details on GIs see the Guidelines, [Part B, Examination, Section 4, Absolute Grounds for Refusal, Chapter 10, Trade Marks in Conflict with Geographical Indications \(Article 7\(1\)\(j\) EUTMR\)](#) , for more information on traditional terms for wines see the Guidelines, [Part B, Examination, Section 4, Absolute Grounds for Refusal, Chapter 11, Trade Marks in Conflict with Traditional Terms for Wines \(Article 7\(1\)\(k\) EUTMR\)](#) , and for more information on traditional specialities guaranteed, see the Guidelines, [Part B, Examination, Section 4, Absolute Grounds for Refusal, Chapter 12, Trade Marks in Conflict with Traditional Specialities Guaranteed \(Article 7\(1\)\(l\) EUTMR\)](#) .

Secondly, the examination of an EU collective mark will also consider the exceptions and particularities of this kind of mark. These exceptions and particularities refer both to the formal and substantive provisions. As regards formalities, the requirement for regulations governing use of the mark is, for example, a specific characteristic of an EU collective mark. (For further details of the examination of formalities of EU collective marks, including the regulations governing use of the mark, see the Guidelines, [Part B, Examination, Section 2, Formalities, paragraph 8.2](#) ).

The substantive exceptions and particularities that apply to an EU collective mark are described below.

## 2 Ownership

Ownership of EU collective marks is limited to (i) associations of manufacturers, producers, suppliers of services, or traders that, under the terms of the law governing them, have the capacity in their own name to have rights and obligations of all kinds, to make contracts or accomplish other legal acts and to sue and be sued; and (ii) legal persons governed by public law ([Article 74 EUTMR](#)).

The first type of owner typically comprises private associations with a common purpose or interest. They must have their own legal personality and capacity to act. As set out in the Guidelines, [Part B, Examination, Section 2, Formalities, paragraph 8.2.1](#), '[c]ollective does not mean that the mark belongs to several persons [co-applicants/co-owners] nor that it designates/covers more than one country'.

Associations may be organised under different legal forms, including that of private corporations (such as *Gesellschaften mit beschränkter Haftung*). However, as the latter are generally not organised as associations, the Office considers that a private

corporation cannot be the owner of an EU collective mark unless it shows that its internal structure is of an associative nature.

The same applies to the second type of owners. Taking into account the essential function of collective marks (i.e. to distinguish the goods or services of the *members of the association* that is the proprietor of the mark from those of other undertakings), ‘legal persons governed by public law’ have to be either associations in a formal sense or need to have an internal structure of an associative nature. This concept includes, for example, associations or corporations governed by public law, such as the *consejos reguladores* or *colegios profesionales* under Spanish law.

When used below, the term ‘association’ refers to either of the aforementioned types of owner acceptable under [Article 74 EUTMR](#).

### 3 Specific Absolute Grounds of Refusal

#### 3.1 Misleading as to the character or meaning of the mark

Under [Article 76\(2\) EUTMR](#), the examiner must refuse the application if the public is liable to be misled as regards the character or the meaning of the mark, in particular if it is likely to be perceived as something other than a collective mark.

This refers to the situation where the mark will not be perceived as a collective mark by the public but rather as an individual or certification mark.

For instance, a collective mark would be misleading to the public if it gives the impression that it is available for use by anyone meeting certain objective standards. However, a collective mark, by nature, cannot be used by non-members of the association (e.g. third party users, licensees, etc.). The regulations governing use contain a clear indication of who is entitled to use the collective mark (any member of the association or if additional requirements for members are in place) and, therefore, they grant to members the status of authorised users of the collective mark. If the regulations governing use permitted use of the collective mark by non-members of the association, this would not comport with the character of the collective mark.

Furthermore, a collective mark will be misleading if it conveys a strong certification



message (for example,  (invented example), which is a clear contradiction of the function of the collective mark).

A collective mark would not be considered misleading as to its character by the sole fact that the regulations governing use may also include specific requirements of use with respect to the quality of the goods and services protected by the mark. However, where examination of the regulations governing use reveals that the mark is actually to be used as a certification mark and not as an indicator that the goods and services come from the members of the association, it will be considered to mislead the public.

Likewise, if **a collective mark consists of**: (i) a GI or (ii) a logo contained in the GI product specification, the public is liable to be misled as regards the character or significance of the mark because these elements may be taken to be a geographical indication rather than a collective mark whose function is to indicate the membership of an association. For more details on GIs see the Guidelines, [Part B, Examination, Section 4, Absolute Grounds for Refusal, Chapter 10, Trade Marks in Conflict with Geographical Indications \(Article 7\(1\)\(j\) EUTMR\)](#).

## 3.2 Regulations governing use

The regulations governing use must be filed within **2 months** of the filing date of the application of the collective mark ([Article 75\(1\) EUTMR](#)) and their content must comply with the requirements of [Article 6 EUTMR](#). For complete details regarding the content of the regulations of use, see the Guidelines, [Part B, Examination, Section 2, Formalities, paragraph 8.2.3, Regulations governing use of collective marks](#).

The Office recommends the use of its template (available at <https://euipo.europa.eu/ohimportal/en/certification-and-collective-marks#23>), which guides applicants through the process of drafting the regulations governing use.

The regulations governing use constitute a mandatory **part** of the collective mark. In particular, they are an **essential element** of the examination since they contain relevant information on the collective mark scheme and thus define the subject matter of protection.

Given their significance, the regulations governing use should be drafted in a **clear and accessible** manner.

The regulations governing use should reflect the specific kind of mark claimed in the application and the fact that the mark is indeed a collective mark, which will be used by the members of the association.

The regulations of use must comply with the formalities requirements (see the Guidelines, [Part B, Examination, Section 2, Formalities, paragraph 8.2.3, Regulations governing use of collective marks](#)), reflect the kind of mark being applied for (see [paragraph 3.1](#) above regarding misleading applications) and comply with public policy and accepted principles of morality.

Substantive examination of the application will begin only once the regulations governing use have been received.

### 3.2.1 Compliance with public policy and morality

If the regulations governing use of the mark are contrary to **public policy** or to **accepted principles of morality**, the EU collective mark application must be refused under [Article 76\(1\) EUTMR](#). This ground for refusal applies in addition to [Article 7\(1\)\(f\) EUTMR](#), which relates in the first place to the sign applied for.

It refers to situations where, regardless of the trade mark, the regulations governing use of the mark contain a provision that is contrary to public policy or to accepted principles of morality. This would be the case, for example, where the authorisation or conditions of use discriminate between market operators without due justification (such as a lack of objective criteria or the application of inadmissible criteria) or where the regulations governing use establish manifestly discriminatory fees.

### 3.2.2 Remedies

In some cases, it will be possible to modify the regulations governing use in order to remove a ground for refusal of an EU collective mark application ([Article 76\(3\) EUTMR](#)) raised by the Office under [Articles 76\(1\) and \(2\) EUTMR](#). In all cases, the applicant has to submit new and complete regulations governing use. The Office will then assess if the objection can be waived as a consequence of the content of the new text.

## 4 Specificities as Regards Examination of the General Absolute Grounds for Refusal

In addition to the specific grounds for refusal applicable to collective marks, applications for this kind of mark need to be examined with regard to the absolute grounds for refusal listed in [Article 7\(1\) EUTMR](#) ([Article 74\(3\) EUTMR](#)). This means that an EU collective mark application will, like any other EUTM application, be assessed on **all** general grounds for refusal laid down in [Article 7\(1\) EUTMR](#), without prejudice to the application of [Article 7\(3\) EUTMR](#).

If, for example, a collective mark is not inherently distinctive under Article 7(1)(b) EUTMR, it will be refused (18/07/2008, [R 229/2006-4](#), CHARTERED MANAGEMENT ACCOUNTANT, § 7).

To the extent that [Article 7\(1\)\(b\), \(c\) or \(d\) EUTMR](#) and the corresponding exception for acquired distinctiveness ([Article 7\(3\) EUTMR](#)) also apply to collective marks, any claim of distinctiveness acquired through use will need to be supported by evidence showing that use of the mark has been made and that the mark is in fact recognised on the relevant market as a collective mark.

### 4.1 Article 74(2) EUTMR: ‘geographical derogation’

Pursuant to [Article 74\(2\) EUTMR](#), by way of derogation from [Article 7\(1\)\(c\) EUTMR](#), signs or indications that may serve, in trade, to designate the geographical origin of the goods or services may constitute EU collective marks.

However, [Article 74\(2\) EUTMR](#) is not an exception to the requirement of distinctiveness. [Article 7\(1\)\(b\)](#) and [Article 7\(3\) EUTMR](#) apply also to EU collective marks. Therefore, where an association applies for registration, as an EU collective mark, of a sign, which may designate a geographical origin, it is incumbent on it to ensure that that sign has elements that enable the consumer to distinguish the goods

or services of its members from those of other undertakings (05/03/2020 [C-766/18 P](#), BBQLOUMI (fig.) / HALLOUMI, EU:C:2020:170, § 72 and 73).

In other words, a sign applied for as an EU collective mark **must have elements capable of distinguishing the goods or services of the members of the association from those of other undertakings to be considered distinctive** within the meaning of [Article 7\(1\)\(b\) EUTMR](#). The Office will assess on a case-by-case basis whether the signs containing geographically descriptive terms, including GIs, contain elements that are sufficient to render the mark distinctive as a collective mark.

Consequently, the exception provided for in [Article 74\(2\) EUTMR](#) is reserved for collective trade marks that are distinctive in the sense of being able to distinguish the goods or services of the members of the association from those of other undertakings, albeit that those marks, at the same time, may serve to designate the geographical origin of the designated goods or services.

For instance, the sign 'ALICANTE' applied for *tourist services* or 'ACEITE DE LA COMUNITAT VALENCIANA' for *edible oils* would be refused under Article 7(1)(b) EUTMR, because they do not contain any elements capable of distinguishing the goods/services of the members of the association from those of other undertakings.

On the other hand, the signs 'ASOCIACION DE GUIAS DE LA CIUDAD DE ALICANTE' (*association of guides of the city of Alicante*) or 'CONSEJO REGULADOR DE LA D.O.P. ACEITE DE LA COMUNITAT VALENCIANA' identify a specific association and might be accepted as collective marks for *tourist services* or *edible oils* respectively pursuant to Article 74(2) EUTMR.

Finally, **trade marks that may serve in trade to designate the geographical origin of the goods and services must in any event** comply with the authorisation set out in [Article 75\(2\) EUTMR](#). According to this provision, the regulations governing use of an EU collective mark **availing of the derogation provided by [Article 74\(2\) EUTMR](#)** must authorise any person whose goods or services originate in the geographical area concerned to become a member of the association that is the proprietor of the mark.

## 4.2 Objections raised under Article 7(1)(j), (k) or (l) EUTMR

In the event that the goods and services have to be limited as a consequence of an objection raised under [Article 7\(1\)\(j\)](#) (geographical indication), [7\(1\)\(k\)](#) (traditional terms for wines) or [7\(1\)\(l\) EUTMR](#) (traditional specialities guaranteed), the applicant of the EU collective mark **has to amend the regulations governing use accordingly** ([Article 16\(h\) EUTMR](#)). For further information regarding these objections, please see the Guidelines, [Part B, Examination, Section 4, Absolute Grounds for Refusal, Chapter 10 Trade Marks in Conflict with Geographical Indications \(Article 7\(1\)\(j\) EUTMR\)](#), [Chapter 11, Trade Marks in Conflict with Traditional Terms for Wines \(Article 7\(1\)\(k\) EUTMR\)](#) and [Chapter 12, Trade Marks in Conflict with Traditional Specialities Guaranteed \(Article 7\(1\)\(l\) EUTMR\)](#).

***GUIDELINES FOR EXAMINATION OF  
EUROPEAN UNION TRADE MARKS***

***EUROPEAN UNION  
INTELLECTUAL PROPERTY OFFICE  
(EUIPO)***

***Part B***

***Examination***

***Section 4***

***Absolute grounds for refusal***

***Chapter 16 European Union certification  
marks***

## Table of Contents

<b>1 Relevant Provisions.....</b>	<b>722</b>
<b>2 Definition and Specific Function.....</b>	<b>722</b>
2.1 Definition.....	722
2.2 Specific function.....	723
<b>3 Main Elements.....</b>	<b>723</b>
3.1 Sign and distinguishing capacity.....	723
3.2 Description as certification mark.....	723
3.3 List of goods and services.....	723
3.4 Regulations governing use.....	724
<b>4 Specific Requirement as Regards Ownership.....</b>	<b>725</b>
<b>5 Examination of the Specific Grounds of Refusal.....</b>	<b>726</b>
5.1 Misleading as to the character or the meaning of the mark.....	726
5.2 Certification of geographical origin.....	726
5.3 Regulations governing use.....	729
5.3.1 Compliance with public order.....	730
5.3.2 Remedies.....	730
<b>6 Specificities as regards examination of the general grounds for refusal..</b>	<b>730</b>



## 1 Relevant Provisions

As of 1 October 2017, the certification mark is **codified as a new kind of European Union trade mark** governed by **specific provisions**. Its main objective is to provide a specific legal framework for protecting EU certification marks (see recital 27 of [Regulation \(EU\) 2015/2424](#) amending [Council Regulation \(EC\) No 207/2009](#)). Until the latest amendment of the EUTMR by Amending [Regulation \(EU\) 2015/2424](#), **certification marks** could not be protected as European Union trade marks.

The relevant specific provisions for certification marks have been laid down in [Chapter VIII EUTMR](#) and are completed by the provision of [Article 17 EUTMR](#). EU designations in international registrations (IRs) are addressed in [Article 194 EUTMR](#).

The **general provisions of the EUTMR apply** to EU certification marks as well, **unless the specific provisions** of Articles [83](#) to [93](#) EUTMR **provide otherwise**. The latter lay down some particularities and exceptions to the general EUTM regime as regards EU certification marks, which need to be taken into account when filing and examining such marks.

## 2 Definition and Specific Function

### 2.1 Definition

The certification mark is a third kind of European Union trade mark established by the EUTMR in addition to the individual trade mark and the collective trade mark.

[Article 83\(1\) EUTMR](#) defines the EU certification mark as a mark that ‘is capable of distinguishing goods or services which are certified by the proprietor of the mark in respect of material, mode of manufacture of goods or performance of services, quality, accuracy or other characteristics, with the exception of geographical origin, from goods and services which are not so certified’.

The **list** of possible characteristics to be certified by an EU certification mark is **non-exhaustive** and can relate to characteristics other than material, mode of manufacture or performance, quality or accuracy. It explicitly **excludes**, however, the possibility of certifying the **geographical origin** of goods or services.

The owner of the certification mark does not necessarily have to provide the certification services itself. It is sufficient that the certification process is conducted under its control and supervision.

## 2.2 Specific function

A certification mark indicates that the goods or services bearing the mark (i) comply with a given standard set out by the owner of the mark (ii) as a result of a control set up by the certification mark owner, (iii) irrespective of the identity of the undertaking that actually produces or provides the goods and services at issue and actually uses the certification mark.

The certification mark's essential distinguishing function, therefore, relates to the **guarantee of specific characteristics** of certain **goods and services**.

## 3 Main Elements

### 3.1 Sign and distinguishing capacity

First, as with any EUTM, a certification mark needs to be a **sign** capable of being represented on the Register of European Union trade marks. In this respect, the general rules apply ([Article 83\(3\)](#) and [Article 4 EUTMR](#)).

Second, the sign should have the **capacity to fulfil the certification mark's specific function** of distinguishing goods or services that are certified with respect to a given standard from those that are not so certified ([Article 83\(1\) and \(3\)](#), [Article 4\(a\)](#) and [Article 7\(1\)\(a\) EUTMR](#)).

### 3.2 Description as certification mark

The applicant for a certification mark has to describe it as such in its application ([Article 83 EUTMR](#)). Therefore, when submitting an application, the applicant will include a **statement** to the effect that the application is for registration of an EU certification mark ([Article 2\(1\)\(i\) EUTMR](#)).

The kind of mark selected by the applicant will not be changed to any other kind of mark unless examination of the application reveals that the kind of mark indicated in the application is **obviously** wrong (see the Guidelines, [Part B, Examination, Section 2, Formalities, paragraph 8.4](#)).

### 3.3 List of goods and services

Certification marks should be applied for in respect of the goods and services that will be certified by the owner of the mark.

The list of goods and services has to comply with the general rules of precision and clarity ([Article 33 EUTMR](#)).

The list does not need to contain an explicit statement that the goods and services listed are subject to certification (in general or against a particular standard), as a certification mark has in any case to be ‘described as such’ in the application.



For example, if the sign  were applied for as a certification mark for *nuts, crackers and muffins* (invented example), there would be no need to explicitly specify *certified by* ‘name of the applicant’, nor *under the certification of the certified vegan logo* or any other indication relating to the certification process itself. The applicant could simply apply for the certification mark for *vegan nuts, vegan crackers and vegan muffins*.

The list of goods and services of an EU certification mark application must also be included in the regulations of use ([Article 17\(d\) EUTMIR](#)). The two lists (goods and services filed in the application and those listed in the regulations of use) must be identical.

### 3.4 Regulations governing use

The regulations governing use must be filed within **2 months** of the application for the certification mark ([Article 84\(1\) EUTMR](#)) and their content must comply with [Article 17 EUTMIR](#). For complete details regarding the content of the regulations of use, see the Guidelines, [Part B, Examination, Section 2, Formalities, paragraph 8.3.3.1, Content of the regulations of use](#).

The substantive examination of the application will begin once the regulations governing use have been received.

The Office recommends the use of its template (available at <https://euipo.europa.eu/ohimportal/en/certification-and-collective-marks#23>), which guides applicants through the process of drafting the regulations governing use.

The regulations governing use constitute a mandatory **part** of the certification mark. In particular, they are an **essential element** of the examination since they contain information on the certification scheme and thus define its subject matter. They must reflect the specific kind of mark claimed in the application and be drafted in a **clear** and **accessible** manner (see [paragraph 5.3](#) below).

If the regulations governing use are amended, the complete modified version of the text must be submitted to the Office ([Article 88\(1\) EUTMR](#)), which will verify that the modifications satisfy the requirements of [Article 84\(2\) EUTMR](#) and [Article 17 EUTMIR](#) and do not raise any grounds for refusal applicable to EU certification marks referred to in [Article 85 EUTMR](#). When the regulations governing use refer to standards established in official or generally available sources, any changes of these standards automatically apply to the regulations governing use. In such cases, it is not necessary to amend the regulations governing use already filed at the Office.

## 4 Specific Requirement as Regards Ownership

**Any** natural or legal person can apply for and be an owner of an EU certification mark. [Article 83\(2\) EUTMR](#) clarifies that this includes ‘institutions, authorities and bodies governed by public law’.

The only, yet important, **limitation** is that a certification mark cannot be owned by a person running a business involving the supply of the goods and services of the kind certified ([Article 83\(2\) EUTMR](#)).

The **owner** of a certification mark is **precluded from using the mark** for the certified goods or services covered.

The reasons are that it would not make much sense that the proprietor certifies its own goods and services; a certifier should be neutral with respect to the business interests of the producers of the goods and the suppliers of the services it certifies.

That ‘**duty of neutrality**’ has to be understood broadly: the proprietor must not have any economic (business) interest on the relevant market.

This is, in particular, not fulfilled where:

- the producer of the goods or the supplier of the services to be certified, although formally distinct from the owner of the certification mark, is economically linked to the latter;
- use of the certification mark is conditioned by use of the goods or services provided by the owner of the certification mark (e.g. when a raw material is supplied by the owner of the certification mark). However, it is acceptable for the owner to provide some training on the certification scheme to its users since (and as long as) it is an economical field that is different from the goods and services of the kind certified.

Non-respect of this duty of neutrality by the owner of a certification mark therefore constitutes a specific ground for revocation of the certification mark ([Article 91 EUTMR](#)); see the Guidelines, [Part D, Cancellation, Section 2, Substantive Provisions](#).

The applicant has to include in the regulations governing use a **declaration** that it complies with this requirement (see Article 17(b) EUTMIR and the Guidelines, [Part B, Examination, Section 2, Formalities](#), for further details).

When examining an application for a certification mark, the Office will assume the applicant’s good faith in this respect and, for example, not object to the application for a certification mark where the applicant already owns a national or European Union mark that covers the goods and services to be certified.

The application will, however, be **rejected if it becomes evident** in the course of the proceedings (e.g. from third-party observations) that the **applicant actually runs a business on the relevant market**.

## 5 Examination of the Specific Grounds of Refusal

### 5.1 Misleading as to the character or the meaning of the mark

Under [Article 85\(2\) EUTMR](#), an EU certification mark application must be refused if the public is liable to be misled as regards the character or the meaning of the mark, in particular if it is likely to be perceived as something other than a certification mark.

The EUTMR does not require that the depiction of the certification mark assumes a specific form or includes a specific text, such as a reference to its kind. The absence of such information does not imply that the mark will be perceived as anything other than a certification mark.

The public is also liable to be misled when **the sign** indicates a quality that is different from or contradicts the subject of the quality standard as stated in the regulations governing use. For example, ‘ABC test pure orange juice’ for *soft drinks*, where the regulations governing use certify that it contains juice made from apples.

To conclude, the perception of the sign by the relevant consumer is decisive. This perception will depend, on the one hand, on the sign itself and, on the other hand, on the specification of use of the mark as laid down in the regulations governing use, and the goods and services covered.

### 5.2 Certification of geographical origin

Pursuant to [Article 83 EUTMR](#), an EU certification mark will not be capable of distinguishing goods or services certified in respect of the geographical origin.



This exception should be understood as a bar to any mark applied for:

- where the **sign** will be **perceived by the relevant public** as an indication that the goods or services at issue will be certified in respect of their geographical origin;
- where the **Regulations of use** indicate that the characteristic being certified is the geographical origin of the goods or services or impose an obligation of geographical nature (e.g. the location of the place of production);
- where the **list of goods and services** explicitly specifies that the goods and services have a geographical origin or comply with a PDO/PGI.

A certification mark that contains an inclusion of, or reference to, a geographical indication (GI) — in its sign, list of goods and services and/or regulations governing use — will be objected to under [Article 83 EUTMR](#) since by definition geographical indications are linked to a specific geographical origin and will be perceived as such. For more details on GIs, see [Part B, Examination, Section 4, Absolute Grounds for refusal, Chapter 10, Trade marks in conflict with Geographical Indications \(Article 7\(1\) \(j\) EUTMR\)](#).

However, when the reference to a geographical term does not imply any geographical origin of the goods and services the application will not fall within the scope of the objection of [Article 83 EUTMR](#).

Examples of applications **refused** under [Article 83 EUTMR](#):

EUTM No	Sign	Goods and services	Reasoning
17 596 917		Classes 29, 30 and 31	<p>In particular, the rules of use clearly state that the certification mark intends to certify a geographical origin, namely that the goods in question originate from animals that have been bred according to certain specifications, among which is the necessary link to Denmark or the Danish area.</p>
17 277 245		Class 9: oils and fats	<p>The sign contains a verbal expression that gives direct information about the geographical origin of the goods (Styrian pumpkin oil).</p> <p>It reproduces a registered PGI '<a href="#">Steirisches Kürbiskernöl</a>' for edible oil.</p> <p>The regulations of use explicitly mention that the goods are certified in relation to their geographical origin.</p>

EUTM No	Sign	Goods and services	Reasoning
17 868 687	VINAGRE DE VINHO DO PORTO	Class 30: wine vinegar	<p>The following elements confirm that the certification mark is intended to certify the geographical origin of the goods applied for:</p> <ol style="list-style-type: none"> <li>1. the representation of the sign contains a registered PDO for wines under Regulation (EU) No 1308/2013, <a href="#">‘Vinho do Porto’</a> (PDO-PT-A1540), in addition to other words;</li> <li>2. the regulations of use filed clearly mention that: “Vinagre de Vinho do Porto” is produced exclusively from wine under the Protected Designation of Origin’.</li> </ol> <p>Both, the representation of the sign applied for and the regulations of use, clearly indicate that the certification mark is intended to certify vinegar that is made exclusively from wine protected under the PDO <a href="#">‘Vinho do Porto’</a> (PDO-PT-A1540), that is to say that that the vinegar’s main ingredient is the PDO <a href="#">‘Vinho do Porto’</a>.</p>

Example of an application containing a geographical term **and registered**:

EUTM No	Sign	Goods and services	Reasoning (under <a href="#">Article 83 EUTMR</a> and the prohibition of geographical origin)
17 870 740		Class 44	<p>The geographical reference in the sign ('German') read in combination with the other word elements and, in particular, the overall expression 'certified by the German cardiac society' will not be perceived as an indication of the geographical origin of the goods and services but as an indication of the certifier itself.</p> <p>There was no element in the regulations of use that would suggest otherwise.</p>

### 5.3 Regulations governing use

Given their particular significance, the regulations governing use should be drafted in a **clear** and **accessible** manner, that is to say, with sufficient clarity and precision to enable both the Office to examine the application and the market operators to understand the requirements that must be met for using the certification mark.

The regulations of use must comply with the formalities requirements (see the Guidelines, [Part B, Examination, Section 2, Formalities, paragraph 8.3.3, Regulations governing use of certification marks](#)), reflect the kind of mark being applied for (see [paragraph 5.1](#) above regarding misleading applications) and comply with public policy and accepted principles of morality.



### 5.3.1 Compliance with public order

The regulations governing use must comply with public policy and accepted principles of morality. This **public order requirement** under [Article 85\(1\) EUTMR](#) **applies specifically to the regulations governing use**. It applies in addition to [Article 7\(1\)\(f\) EUTMR](#) (which relates in the first place to the sign applied for) and thus needs to be assessed separately and specifically with respect to the regulations governing use submitted by the applicant.

By way of example, regulations governing use would appear to be in breach of [Article 85 EUTMR](#) where:

1. the applicant would not be entitled to carry out the certification (e.g. for lack of compliance with statutory provisions);
2. the authorisation or conditions of use discriminate between market operators without due justification (such as a lack of objective criteria or the application of inadmissible criteria).

### 5.3.2 Remedies

In some cases, it will be possible to modify the regulations governing use in order to remove a ground for refusal of an EU certification mark application ([Article 85\(3\) EUTMR](#)) raised by the Office under [Articles 85\(1\) and \(2\) EUTMR](#). The applicant has to submit new and complete regulations governing use. The Office will then assess if the objection can be waived as a consequence of the content of the new text.

## 6 Specificities as regards examination of the general grounds for refusal

In addition to the specific grounds for refusal applicable to certification marks, applications for this kind of mark need also to be examined with regard to the absolute grounds for refusal listed in [Article 7\(1\) EUTMR](#) ([Article 85\(1\) EUTMR](#)). This means that EU certification mark applications will, like any other EUTM application, be assessed on **all** general grounds of refusal laid down in [Article 7\(1\) EUTMR](#) (27/10/2021, [R 1410/2019-5](#), Manuka honey, § 18-28, 37; 27/10/2021, [R 2110/2019-5](#), Bio-Mineralwasser I, § 15-25; 27/10/2021, [R 2112/2019-5](#), bio mineralwasser (fig.) II, § 15-25).

Example of a refused application under [Article 7\(1\)\(b\) and \(c\) EUTMR](#).

Sign and goods and services	Case No
MANUKA HONEY for <i>honey</i>	27/10/2021, <a href="#">R 1410/2019-5</a> , Manuka honey, § 20, 21, 24, 27, 37

**Reasoning:** [...] according to [Article 83\(3\) EUTMR](#), Chapters I to VII and IX to XIV of the EUTMR will apply to EU certification marks to the extent that this section does not provide otherwise. Chapter VIII, Section 2 (EU certification marks) does not contain any *lex specialis* to [Article 7 EUTMR](#) of Chapter II of the EUTMR. In particular, whereas [Article 74\(2\) EUTMR](#) includes an explicit derogation from [Article 7\(1\) EUTMR](#) for EU collective marks, such a derogation does not exist for EU certification marks (§ 20).

Finally, Article [4\(a\)](#), Article [7\(1\)\(b\)](#) and Articles [74\(1\)](#) and [83\(1\)](#) EUTMR all refer to the distinguishing function as the key element for defining EU trade marks, be it ordinary trade marks, collective marks or certification marks (§ 21).

When assessing the distinctive character of an EU certification mark under [Article 85\(1\) EUTMR](#) in combination with [Article 7\(1\)\(b\) EUTMR](#), one also has to bear in mind the specific function of those types of marks in comparison with ordinary trade marks (§ 24).

From the perspective of the English-speaking public, the term 'Manuka honey' simply refers to a type of honey, like 'Dandelion honey', 'Pinetree honey' or 'Acacia honey'. As a purely generic indication, it does not fulfil the primary function of a certification mark, namely to distinguish certified honey from honey that is not certified. Thus, the examiner rightly refused protection for the mark pursuant to [Article 85\(1\) EUTMR](#) in combination with Article [7\(1\)\(b\)](#) and Article [7\(2\)](#) EUTMR in relation to the goods applied for, namely 'honey' (§ 37).

When assessing the general grounds of refusal of [Article 7\(1\)\(b\), \(c\) and \(d\) EUTMR](#), the specific function of certification marks – that is to distinguish goods or services certified by one certifier (i) from those that are not certified at all and (ii) from those certified by another certifier – must always be kept in mind.

Likewise, to the extent that [Article 7\(1\)\(b\), \(c\) or \(d\) EUTMR](#) and the corresponding exception for acquired distinctiveness ([Article 7\(3\) EUTMR](#)) also apply to certification marks, any claim of distinctiveness acquired through use will need to be supported by evidence showing that use of the mark has been made and that the mark is in fact recognised on the relevant market as a certification mark.

The same applies to [Article 7\(1\)\(g\) EUTMR](#) to the extent that it remains applicable in addition to the specific provision of [Article 85\(2\) EUTMR](#). When assessing whether or not the public is liable to be misled as regards the character or the meaning of the mark, the regulations governing use must also be taken into account. For example, if the characteristic to be certified is the kosher nature of the goods, and the certification mark applied for designates food that by its very nature cannot be kosher (e.g. shellfish), an objection under [Article 7\(1\)\(g\) EUTMR](#) should be raised since there is no possibility of non-deceptive use of the certification mark.

When the sign applied for contains a geographical indication, an objection will be raised under [Article 83\(1\) EUTMR](#) only (and not under [Article 7\(1\)\(j\) EUTMR](#)) given that a limitation of the goods can never overcome the prohibition of certification of geographical origin laid down in [Article 83\(1\) EUTMR](#).

---

***GUIDELINES FOR EXAMINATION OF  
EUROPEAN UNION TRADE MARKS***

***EUROPEAN UNION  
INTELLECTUAL PROPERTY OFFICE  
(EUIPO)***

***Part C***

***Opposition***

---

## Table of Contents

<b>Section 0 Introduction.....</b>	<b>734</b>
<b>Section 1 Opposition proceedings.....</b>	<b>742</b>
<b>Section 2 Double identity and likelihood of confusion.....</b>	<b>863</b>
<b>Section 3 Unauthorised filing by agents of the TM proprietor (Article 8(3) EUTMR).....</b>	<b>1155</b>
<b>Section 4 Non-registered trade marks and other signs used in the course of trade (Article 8(4) EUTMR).....</b>	<b>1185</b>
<b>Section 5 Trade marks with reputation (Article 8(5) EUTMR).....</b>	<b>1211</b>
<b>Section 6 Geographical Indications (Article 8(6) EUTMR).....</b>	<b>1301</b>
<b>Section 7 Proof of use.....</b>	<b>1315</b>

***GUIDELINES FOR EXAMINATION OF  
EUROPEAN UNION TRADE MARKS***

***EUROPEAN UNION  
INTELLECTUAL PROPERTY OFFICE  
(EUIPO)***

***Part C***

***Opposition***

***Section 0***

***Introduction***

## Table of Contents

<b>1 Overview of Opposition Proceedings — the Difference Between ‘Absolute Grounds’ and ‘Relative Grounds’ for Refusal of an EUTM Application.....</b>	<b>736</b>
<b>2 The Grounds for Opposition.....</b>	<b>736</b>
<b>3 The ‘Earlier Rights’ upon which an Opposition must be Based.....</b>	<b>737</b>
<b>4 The Purpose of Opposition Proceedings and the Most Expedient Way to Treat Them.....</b>	<b>739</b>
<b>4.1 Examination of the most effective opposition, ground and bases.....</b>	<b>739</b>
<b>4.2 No need to examine proof of use.....</b>	<b>740</b>
<b>4.3 Restricting the examination to part of the relevant public.....</b>	<b>740</b>
<b>4.4 Examining the likelihood of confusion without undertaking a comparison of goods and services.....</b>	<b>741</b>
<b>4.5 No need to examine evidence of enhanced distinctiveness.....</b>	<b>741</b>

## 1 Overview of Opposition Proceedings — the Difference Between ‘Absolute Grounds’ and ‘Relative Grounds’ for Refusal of an EUTM Application

‘Opposition’ is a procedure that takes place before the EUIPO when a third party requests the Office to reject a European Union trade mark application (EUTM application) or an international registration designating the EU on the basis of the earlier rights it holds.

When an opposition is filed against an international registration designating the EU, any reference in these Guidelines to EUTM applications must be read to cover international registrations designating the EU. The Guidelines, Part M, International Marks, cover the specific details of oppositions related to international registrations.

Under [Regulation \(EU\) 2017/1001](#) of the European Parliament and of the Council of 14 June 2017 on the European Union trade mark, an opposition must be based on rights held by the opponent in an earlier trade mark or other form of trade sign. The grounds on which an opposition may be based are called ‘relative grounds for refusal’, and the relevant provisions are found in [Article 8 EUTMR](#), which bears that title. Unlike absolute grounds for refusal, which are examined *ex officio* by the Office (and which may take into account third parties’ observations although third parties do not become parties to the proceedings), relative grounds for refusal are *inter partes* proceedings based on likely conflict with earlier rights. Such relative grounds objections are not raised *ex officio* by the Office. The onus is therefore on the proprietor of the earlier right to be vigilant concerning the filing of EUTM applications by others that could clash with such earlier rights, and to oppose conflicting marks when necessary.

When an opposition is filed within a prescribed time limit and the relevant fee has been paid, the proceedings are managed by the Office’s specialist service (the Opposition Division). The Opposition Division will first examine the admissibility of the opposition. If the opposition is found admissible, normally an exchange of observations from both the opponent and the applicant (the ‘parties’) will follow. After considering these observations, and if agreement has not been reached between the parties, the Opposition Division will decide (in an appealable ‘decision’) either to reject the contested application totally or in part or to reject the opposition. If the opposition is not well founded, it will be rejected. If the EUTM application is not totally rejected, and provided there are no other oppositions pending, it will proceed to registration for the goods and/or services for which it is not rejected.

## 2 The Grounds for Opposition

The grounds on which an opposition may be made are set out in Article 8 EUTMR.

[Article 8 EUTMR](#) enables the proprietors to base oppositions on their earlier rights to prevent the registration of EUTMs in a range of situations progressing from that of double identity both between goods and/or services and between marks ([Article 8\(1\)](#))

[\(a\) EUTMR](#), where likelihood of confusion is presumed, and need not be proved) to that of identity only in one factor and similarity in the other, or similarity in both ([Article 8\(1\)\(b\) EUTMR](#), where a likelihood of confusion must be established) (see the Guidelines, [Part C, Opposition, Section 2, Double Identity and Likelihood of Confusion](#)).

[Article 8\(3\) EUTMR](#) allows the proprietor of a mark to prevent the unauthorised filing of its mark by its agent or representative (see the Guidelines, [Part C, Opposition, Section 3, Unauthorised Filing by Agents of the TM Proprietor](#)).

[Article 8\(4\) EUTMR](#) enables the proprietor of earlier non-registered trade marks or other signs used in the course of trade of more than mere local significance to prevent registration of a later EUTM application if the proprietor has the right to prohibit the use of the EUTM application. It enables rights holders to invoke a wide variety of rights protected under EU legislation or Member State laws, subject to the conditions of their acquisition and scope of protection under the applicable laws, and further provided that the right invoked also fulfils the EU law condition of use in the course of trade of more than mere local significance [see the Guidelines, [Part C, Opposition, Section 4, Non-registered trade marks and other signs used in the course of trade \(Article 8\(4\) EUTMR\)](#)].

[Article 8\(5\) EUTMR](#) enables the proprietors of an earlier reputed registered trade mark to prevent registration of a later similar or identical EUTM application that, without due cause, would encroach on the earlier reputed mark. Likelihood of confusion is not a condition for the application of this article. This is because [Article 8\(5\) EUTMR](#) specifically (but not exclusively) protects functions and uses of trade marks that fall outside the ambit of the badge of origin protection offered by likelihood of confusion and, as such, is more directed at protecting the heightened effort and financial investment that is involved in creating and promoting trade marks to the extent that they become reputed and to facilitate full exploitation of the value of the marks (see the Guidelines, [Part C, Opposition, Section 5, Trade Marks with Reputation \(Article 8\(5\) EUTMR\)](#)).

[Article 8\(6\) EUTMR](#) enables beneficiaries of the protection of designations of origin and geographical indications under the Union legislation or Member State laws to oppose the registration of a later EUTM application even beyond the limited scope of *ex officio* protection of such rights on absolute grounds ([Article 7\(1\)\(j\) EUTMR](#)). In order to be eligible as a ‘relative’ ground for refusal, the right invoked must vest in its beneficiary a direct right of action against unauthorised use [see the Guidelines, [Part C, Opposition, Section 6, Geographical indications \(Article 8\(6\) EUTMR\)](#)].

### **3 The ‘Earlier Rights’ upon which an Opposition must be Based**

An opposition must be based on at least one earlier right owned by the opponent.

The meaning of ‘earlier’ rights for [Article 8\(1\) and \(5\) EUTMR](#) is defined in [Article 8\(2\) EUTMR](#), meaning such rights having an earlier date (not hour or minute, as confirmed by the Court in its judgment of 22/03/2012, [C-190/10](#), Rizo, EU:C:2012:157) of



application for registration than the EUTM application, including applicable claimed priority dates, or have become well known in a Member State before the EUTM application or, if appropriate, its claimed priority date. See the Guidelines, [Part C, Opposition, Section 1, Opposition Proceedings](#).

In essence, these rights consist of EU registered trade marks and applications for such, and ‘well-known’ marks in the sense of Article 6*bis* of the Paris Convention (which need not be registered). For a detailed explanation of these ‘well-known’ marks under Article 8(2)(c) EUTMR, and how they differ from Article 8(5) EUTMR marks with reputation, see the Guidelines, [Part C, Opposition, Section 5: Trade Marks with Reputation \(Article 8\(5\) EUTMR\), paragraph 2.1.2](#).

Under [Article 8\(3\) EUTMR](#), the opponent must show that it is the proprietor of a trade mark, acquired anywhere in the world by registration or by use (to the extent that the law of the country of origin recognises this kind of trade mark right), for which an agent or representative of the proprietor has applied for registration in its own name without the proprietor’s consent.

[Article 8\(4\) EUTMR](#) is the ground for opposition based on earlier non-registered trade marks or other signs used in the course of trade of more than mere local significance protected under EU legislation or Member State laws that confer on their proprietor the right to prohibit the unauthorised use of a subsequent trade mark. The opponent must prove that it acquired the right invoked, which may be use or registration based, before the application date or, as the case may be, before the priority date of the contested mark, in accordance with the conditions of protection of the applicable law. In addition, the opponent must also prove use of more than mere local significance of such a right before the date of priority of the contested mark.

[Article 8\(6\) EUTMR](#) is the ground for opposition based on designations of origin or geographical indications protected under EU legislation or Member State laws that confer on the person authorised under such laws the right to prohibit the unauthorised use of a subsequent trade mark. The opponent must prove that the designation of origin or geographical indication invoked is earlier than the date of application or, as the case may be, the priority date of the contested mark.

Various legal grounds, based on different earlier rights, may be alleged in either the same or multiple oppositions against the same EUTM application.

The Office’s practice is based on the legal provisions of the EUTMR applied directly or by analogy, as confirmed by the case-law of the General Court (16/09/2004, [T-342/02](#), Moser Grupo Media, S.L., EU:T:2004:268; 11/05/2006, [T-194/05](#), Teletech International, EU:T:2006:124). Namely:

- **multiple oppositions.** [Article 9\(2\) and \(3\) EUTMDR](#) allows the Office to examine only the ‘most effective’ opposition(s), suspending the rest and eventually deeming them to have been dealt with if the application is rejected on the basis of the chosen opposition. With regard to the ‘most effective’ opposition, see below.
- **multiple earlier rights in one opposition.** The Court has observed that grouping various earlier rights in one opposition is, for practical purposes, the same as presenting multiple oppositions, making it possible for the Office to base the

rejection of the application on the ‘most effective’ right(s). With regard to the ‘most effective’ earlier right, see below.

- **multiple legal grounds in opposition(s)**. If the opposition is successful in its entirety on the basis of the ‘most effective’ legal ground(s), it is not necessary to examine the remaining legal grounds. If a necessary requirement of a legal ground is not fulfilled, it is not necessary to examine the remaining requirements of that provision. With regard to the ‘most effective’ legal ground(s), see below.

## 4 The Purpose of Opposition Proceedings and the Most Expedient Way to Treat Them

The Court of Justice has stated that the sole purpose of opposition proceedings is to decide whether the application may proceed to registration and not to pre-emptively settle potential conflicts (e.g. at a national level arising from the possible conversion of the EUTM application) (11/05/2006, [T-194/05](#), Teletch International, EU:T:2006:124, § 25-27).

### 4.1 Examination of the most effective opposition, ground and bases

The Court of Justice has confirmed clearly that the Office is under no obligation to examine all the earlier oppositions, rights and legal grounds invoked against the same EUTM application, if one of them suffices to reject the EUTM application. Nor is it obliged to choose the earlier right with the widest territorial scope so as to prevent the eventual conversion of the application in as many territories as possible (16/09/2004, [T-342/02](#), Moser Grupo Media, S.L., EU:T:2004:268; 11/05/2006, [T-194/05](#), Teletch International, EU:T:2006:124).

This principle allows for a more expedient treatment of oppositions. The Office is free to choose what it regards as the ‘most effective’ opposition(s), earlier right(s) and legal ground(s) and which one to examine first in light of the principle of procedural economy.

**The ‘most effective’ opposition** can normally be defined as the opposition that allows the Office to refuse the registration of the opposed EUTM application to the broadest possible extent and in the simplest manner.

**The ‘most effective’ earlier right** can normally be defined as the most similar (the closest) sign covering the broadest scope of goods and services and/or the right covering the most similar goods and services.

**The ‘most effective’ legal ground** can normally be defined as the opposition ground that presents the Office with the simplest manner of refusing the registration of the opposed EUTM application to the broadest possible extent.

Generally speaking, if applicable, [Article 8\(1\)\(a\) EUTMR](#) will be the simplest ground in terms of procedural economy on which to reject an EUTM application, since the Office

will not need to enter into an analysis of similarities and differences between the signs or goods/services, nor will a finding of likelihood of confusion be necessary. Failing that, the factual circumstances of each opposition will determine whether [Article 8\(1\)\(b\), Article 8\(3\), \(4\), \(5\) or \(6\) EUTMR](#) are the next ‘most effective’ grounds (e.g. if the goods and services of the earlier right and the EUTM application are dissimilar, [Article 8\(1\)\(b\) and Article 8\(3\) EUTMR](#) cannot serve as a valid basis for opposition).

## 4.2 No need to examine proof of use

If evidence of use has been requested by the applicant in relation to some of the earlier rights, the Office will normally firstly consider if the opposition can be fully upheld on the basis of one or more earlier rights not subject to the requirement to prove use. In such a case, the EUTM application will be rejected without it being necessary to consider proof of use. Only if no such earlier right(s) is (are) available, will the Office consider those earlier rights for which proof of use was requested.

For further examples of where the assessment of the proof of use may be dispensed with, see the Guidelines, [Part C, Opposition, Section 7, Proof of Use, paragraph 10.2](#).

## 4.3 Restricting the examination to part of the relevant public

When an opposition is filed pursuant to [Article 8\(1\)\(b\) EUTMR](#) and a likelihood of confusion can be found on the basis of a (substantial) part of the public, the reasoning of the decision should concentrate on that part of the public that **is most prone to confusion** and the analysis should not extend to all parts. This would apply in particular in the following situations.

- Where there is likelihood of confusion in a specific linguistic area, the Office’s analysis need not extend to the whole EU but may instead focus on that part (see the Guidelines, [Part C, Opposition, Section 2, Double Identity and Likelihood of Confusion, Chapter 4, Comparison of Signs, paragraph 1.3, Relevant territory and relevant public](#)). For example, if the degree of similarity between the marks is higher from the perception of a particular language, the examination of the perception of the marks by the public in other language areas (e.g. examining specific pronunciations or meanings of marks in several languages) is superfluous.
- Where the relevant public consists of both general and professional consumers, the finding of a likelihood of confusion in relation to just one part of the public is sufficient to uphold an opposition. Usually it is the general public that is more prone to confusion. Consequently, if the likelihood of confusion is to be confirmed on the part of the general public, there is no need to examine it based on the perception of professionals.

In such circumstances, it should be explained from the beginning of the decision why such a focus has been chosen.

#### **4.4 Examining the likelihood of confusion without undertaking a comparison of goods and services**

When the opposition is based on [Article 8\(1\)\(b\) EUTMR](#) and the likelihood of confusion cannot be ruled out on the basis of a 'dissimilarity of the goods and services' or 'dissimilarity of the signs', the Office could decide, for reasons of procedural economy, to proceed on the basis of the **assumption that all the goods and services at issue are identical** (20/09/2019, [T-367/18](#), UKIO / <IO (fig.), EU:T:2019:645, § 27-28, 31, 63). The comparison of the goods and services may be dispensed with, even in the absence of any identical pair of goods and services, if upon examining all the other relevant factors (such as the degree of similarity of the signs, distinctiveness of the earlier mark, degree of attention of the relevant public and the principle of interdependence) **any likelihood of confusion can be ruled out**.

#### **4.5 No need to examine evidence of enhanced distinctiveness**

The Office may decide not to examine the opponent's claim and evidence of enhanced distinctiveness of the earlier marks, if based on the other relevant factors a **likelihood of confusion can be established** on the basis of the inherent distinctiveness of the marks.

Where appropriate, the Office may decide to proceed on the basis of the **assumption that the earlier marks enjoy enhanced distinctiveness**. The examination of the claim and evidence of enhanced distinctiveness of the earlier marks may be dispensed with if upon examining all the other relevant factors **any likelihood of confusion can be ruled out**.

***GUIDELINES FOR EXAMINATION OF  
EUROPEAN UNION TRADE MARKS***

***EUROPEAN UNION  
INTELLECTUAL PROPERTY OFFICE  
(EUIPO)***

***Part C***

***Opposition***

***Section 1***

***Opposition proceedings***

## Table of Contents

<b>1 Introduction — General Outline of Opposition Proceedings.....</b>	<b>749</b>
<b>2 Notice of Opposition.....</b>	<b>750</b>
<b>2.1 Notice of opposition in writing.....</b>	<b>750</b>
2.1.1 Early oppositions against an international registration.....	751
2.1.2 Early opposition against an EUTM application.....	751
<b>2.2 Payment.....</b>	<b>751</b>
2.2.1 Notice of opposition late, payment within the opposition period.....	751
2.2.2 Time of payment.....	752
2.2.2.1 Payment by bank transfer.....	752
2.2.2.2 Payment by current account.....	752
2.2.3 Consequences in the event of non-payment.....	753
<b>2.3 Languages and translation of the notice of opposition.....</b>	<b>754</b>
2.3.1 Language of proceedings.....	754
2.3.2 Examples.....	755
<b>2.4 Admissibility check.....</b>	<b>756</b>
2.4.1 Absolute admissibility requirements.....	757
2.4.1.1 Identification of the contested EUTM application.....	757
2.4.1.2 Identification of earlier marks or rights.....	757
2.4.1.3 Identification of grounds.....	761
2.4.2 Relative admissibility requirements.....	762
2.4.2.1 Dates.....	762
2.4.2.2 Representation of earlier marks.....	762
2.4.2.3 Goods and services.....	763
2.4.2.4 Extent of opposition.....	765
2.4.2.5 Earlier mark with a reputation: territorial scope of reputation.....	765
2.4.2.6 Identification of the opponent.....	766
2.4.2.7 Indication of entitlement.....	767
2.4.2.8 Professional representation.....	770
2.4.2.9 Signature.....	770
2.4.2.10 Relative admissibility requirements: sanctions.....	770
<b>2.5 Notification of the admissibility of the opposition and the commencement of the adversarial part of the procedure.....</b>	<b>771</b>
<b>3 Cooling-off Period.....</b>	<b>772</b>
<b>3.1 Setting the cooling-off period.....</b>	<b>772</b>

<b>3.2 Extension of the cooling-off period.....</b>	<b>772</b>
<b>4 Adversarial Stage.....</b>	<b>773</b>
<b>4.1 Completion of the opposition.....</b>	<b>773</b>
<b>4.2 Substantiation.....</b>	<b>774</b>
4.2.1 EUTMs and EUTM applications.....	775
4.2.2 Converted EUTMs and EUTM applications.....	775
4.2.2.1 Opposition based on EUTM (application) (to be) converted.....	775
4.2.2.2 Opposition based on an EUTM (application) that is subsequently converted.....	775
4.2.3 Trade mark registrations or applications that are not EUTMs.....	776
4.2.3.1 Certificates issued by the appropriate official body.....	776
4.2.3.2 Extracts from official databases.....	776
4.2.3.3 Extracts from official bulletins of the relevant national trade mark offices and WIPO.....	778
4.2.3.4 Evidence of renewal.....	778
4.2.3.5 Entitlement to file the opposition.....	779
4.2.3.6 Verification of the evidence.....	780
4.2.4 Substantiation of other grounds and basis of opposition.....	781
4.2.4.1 Well-known marks.....	781
4.2.4.2 Marks with reputation.....	782
4.2.4.3 Non-registered trade mark or another sign used in the course of trade.....	782
4.2.4.4 Geographical indications.....	783
4.2.4.5 Mark filed by an agent or representative.....	785
4.2.5 Non-compliance with the substantiation requirements.....	785
4.2.6 Facts and evidence submitted after the substantiation time limit.....	786
4.2.6.1 Whether discretionary power can be exercised.....	787
4.2.6.2 Whether late facts or evidence should be admitted or rejected.....	787
4.2.6.3 Treatment of late evidence in proceedings.....	788
<b>4.3 Translation/changes of language during the opposition proceedings....</b>	<b>788</b>
4.3.1 Translations of facts, evidence and arguments submitted by the opponent to complete its file.....	789
4.3.1.1 Translation of evidence of filing, registration or renewal certificates or equivalent documents, and provisions of the applicable national law.....	789
4.3.1.2 Translations of evidence submitted to substantiate the opposition other than filing, registration or renewal certificates or equivalent documents, or provisions of the applicable national law.....	791
4.3.1.3 Translations of facts and arguments submitted by the opponent to complete its file.....	791
4.3.2 Translation of further observations and other requests.....	792

4.3.3 Translation of supporting documents other than observations.....	793
4.3.4 Change of language during opposition proceedings.....	794
<b>4.4 Requests and other documents related issues.....</b>	<b>794</b>
4.4.1 Restrictions, withdrawals and requests for proof of use to be filed by way of a separate document.....	794
4.4.2 Documents not readable.....	795
4.4.3 No return of original documents.....	795
4.4.4 Confidential information.....	795
4.4.5 References made to documents or items of evidence in other proceedings.....	796
<b>4.5 Further exchanges.....</b>	<b>797</b>
<b>4.6 Observations by third parties.....</b>	<b>797</b>
<b>5 Procedure related to the request for proof of use.....</b>	<b>798</b>
<b>5.1 Admissibility of the request for proof of use.....</b>	<b>798</b>
5.1.1 Time of request.....	799
5.1.2 Earlier mark registered for not less than 5 years (mark outside the ‘grace period’).....	799
5.1.2.1 Earlier EUTMs.....	800
5.1.2.2 Earlier international registrations designating the European Union.....	800
5.1.2.3 Earlier national marks.....	800
5.1.2.4 Earlier international registrations designating a Member State.....	801
5.1.2.5 Summary of calculation of the beginning of the grace period.....	803
5.1.3 Request must be unconditional, explicit and unambiguous.....	804
5.1.4 Request made in a separate document.....	805
5.1.5 Applicant’s interest to deal with proof of use first.....	806
5.1.6 Consequences of an inadmissible request for proof of use.....	806
<b>5.2 Express invitation by the Office.....</b>	<b>807</b>
<b>5.3 Reaction from the opponent: providing proof of use.....</b>	<b>807</b>
5.3.1 Time limit for providing proof of use.....	807
5.3.2 Means of evidence.....	809
5.3.2.1 Principles.....	809
5.3.2.2 References.....	810
5.3.2.3 Declarations.....	810
<b>5.4 Reaction from the applicant.....</b>	<b>813</b>
5.4.1 Forwarding of evidence.....	813
5.4.2 No evidence or no relevant evidence submitted.....	813
5.4.3 No reaction from applicant.....	813
5.4.4 Formal withdrawal of the request.....	814



<b>5.5 Further reaction from the opponent.....</b>	<b>814</b>
<b>5.6 Languages in proof of use proceedings.....</b>	<b>814</b>
<b>6 Termination of Proceedings.....</b>	<b>815</b>
<b>6.1 Friendly settlement.....</b>	<b>815</b>
<b>6.2 Restrictions and withdrawals.....</b>	<b>816</b>
6.2.1 Restrictions and withdrawals of EUTM applications.....	816
6.2.1.1 Withdrawal or restriction before the admissibility check is made.....	817
6.2.1.2 Restrictions and withdrawals of EUTM applications before the end of the cooling-off period.....	817
6.2.1.3 Restrictions and withdrawals of EUTM applications after the end of the cooling-off period.....	818
6.2.1.4 Restrictions and withdrawals of EUTM applications after a decision has been taken.....	819
6.2.1.5 Language.....	819
6.2.2 Withdrawal of oppositions.....	820
6.2.2.1 Withdrawal of the opposition before the end of the cooling-off period.....	820
6.2.2.2 Withdrawal of the opposition after the end of the cooling-off period.....	820
6.2.2.3 Withdrawal of the opposition after a decision has been taken.....	820
6.2.2.4 Language.....	821
6.2.3 Withdrawals of withdrawals/restrictions.....	821
<b>6.3 Decision on substance.....</b>	<b>821</b>
6.3.1 Earlier right not proven.....	821
6.3.2 Earlier right has ceased to exist.....	822
<b>6.4 Fee refund.....</b>	<b>822</b>
6.4.1 Opposition deemed not entered.....	822
6.4.1.1 Opposition and withdrawal of the opposition filed the same date.....	822
6.4.1.2 Refund after republication.....	823
6.4.2 Refund in view of withdrawals/restrictions of the EUTM application.....	823
6.4.2.1 EUTM application withdrawn/restricted before end of cooling-off period.....	823
6.4.2.2 Opposition withdrawn due to restriction of EUTM application within cooling-off period.....	823
6.4.3 Multiple oppositions and refund of 50 % of opposition fee.....	823
6.4.4 Cases where the opposition fee is not refunded.....	824
6.4.4.1 Opposition withdrawn before the end of the cooling-off period NOT due to a restriction.....	824
6.4.4.2 Opponent's withdrawal is earlier.....	824
6.4.4.3 Settlement between the parties before commencement of proceedings.....	824
6.4.4.4 Termination of proceedings for other reasons.....	824

<b>6.5 Decision on the apportionment of costs.....</b>	<b>825</b>
6.5.1 Cases in which a decision on costs must be taken.....	825
6.5.2 Cases in which a decision on costs is not taken.....	825
6.5.2.1 Agreement on costs.....	825
6.5.2.2 Information from potential 'successful party'.....	826
6.5.3 Standard cases of decisions on costs.....	826
6.5.4 Cases that did not proceed to judgment.....	827
6.5.4.1 Multiple oppositions.....	827
6.5.4.2 Rejection of an application on the basis of absolute grounds or formalities.....	828
6.5.4.3 Cases of joinder.....	828
6.5.4.4 The meaning of 'bear one's own costs'.....	828
<b>6.6 Fixing of costs.....</b>	<b>828</b>
6.6.1 Amounts to be fixed.....	829
6.6.2 Procedure if the fixing of costs is contained in the main decision.....	830
6.6.3 Procedure if a separate fixing of costs is needed.....	830
6.6.3.1 Admissibility.....	830
6.6.3.2 Evidence.....	830
6.6.4 Review of fixing of costs.....	830
<b>7 Other Procedural Issues.....</b>	<b>831</b>
<b>7.1 Correction of mistakes.....</b>	<b>831</b>
7.1.1 Correction of mistakes in the notice of opposition.....	831
7.1.2 Correction of mistakes and errors in publications.....	831
<b>7.2 Time limits.....</b>	<b>832</b>
7.2.1 Extension of time limits in opposition proceedings.....	832
7.2.1.1 Non-extendable and extendable time limits.....	832
7.2.1.2 Conditions of the request.....	832
7.2.1.3 Extension of a time limit by the Office on its own initiative.....	833
<b>7.3 Suspension.....</b>	<b>834</b>
7.3.1 Suspension requested by both parties.....	834
7.3.2 Suspensions by the Office <i>ex officio</i> or at the request of one of the parties.....	834
7.3.2.1 Explanation of the basic principle, timing of suspension.....	835
7.3.2.2 Earlier EUTM applications or registrations.....	836
7.3.2.3 Earlier national/international marks (applications or registrations/rights).....	836
7.3.2.4 Examples.....	837
7.3.3 Multiple oppositions.....	837
7.3.3.1 After rejection of the EUTM application.....	837
7.3.4 Procedural aspects.....	838

7.3.4.1 Monitoring suspended files.....	838
7.3.4.2 Resuming the proceedings.....	838
7.3.4.3 Calculation of time limits.....	838
<b>7.4 Multiple oppositions.....</b>	<b>839</b>
7.4.1 Multiple oppositions and restrictions.....	839
7.4.2 Multiple oppositions and decisions.....	840
7.4.2.1 All oppositions against the same EUTM application are ready for decision at the same time.....	840
7.4.2.2 Only one opposition is ready for decision and the other oppositions are still in the adversarial phase of the proceedings.....	841
7.4.2.3 Two or more oppositions are ready for decision and others are still in the adversarial phase of the proceedings.....	842
7.4.3 Joinder of proceedings.....	842
<b>7.5 Change of parties (transfer, change of name, change of representative, interruption of proceedings).....</b>	<b>843</b>
7.5.1 Transfer and opposition proceedings.....	843
7.5.1.1 Introduction and basic principle.....	843
7.5.1.2 Transfer of earlier EUTM.....	843
7.5.1.3 Transfer of earlier national registration.....	845
7.5.1.4 Opposition based on a combination of EUTM registrations and national registrations.....	846
7.5.1.5 Transfer of the contested EUTM application.....	846
7.5.1.6 Partial transfer of a contested EUTM application.....	846
7.5.2 Parties are the same after transfer.....	847
7.5.3 Change of names.....	847
7.5.4 Change of representatives.....	847
7.5.5 Interruption of the proceedings due to death or legal incapacity of the applicant or its representative.....	848
7.5.5.1 Death or legal incapacity of the applicant.....	848
7.5.5.2 Applicant prevented from continuing the proceedings before the Office owing to legal reasons (e.g. bankruptcy).....	848
7.5.5.3 Death or legal incapacity of the applicant's representative.....	850
<b>Annex — Calculation of the grace period for non-use in the case of national marks.....</b>	<b>850</b>

## 1 Introduction — General Outline of Opposition Proceedings

Opposition proceedings start upon receipt of the notice of opposition, of which the applicant is informed and which can be accessed in the electronic file accessible on the Office's website.

Once the notice of opposition is received, the Office checks that the corresponding opposition fee has been paid. If the fee has not been paid, the opposition is deemed not to have been filed.

Next, the Office verifies the admissibility of the opposition. There are two kinds of admissibility deficiencies.

1. **Absolute deficiencies:** deficiencies that cannot be remedied after the expiry of the opposition period. If the opponent does not remedy these deficiencies on its own initiative within the opposition period, the opposition is inadmissible.
2. **Relative deficiencies:** deficiencies that can be remedied after the expiry of the opposition period. The Office invites the opponent after the expiry of the opposition period to remedy the deficiency within a non-extendable time limit of 2 months, failing which the opposition will be rejected as inadmissible.

It is important to note that, in order to safeguard the principle of impartiality, the Office will not send any communication concerning the payment of the opposition fee or admissibility deficiencies during the opposition period. The admissibility of the opposition will be determined only once the opposition period is over.

After the examination of admissibility of the opposition, a notification is sent to both parties to set the time limits for the proceedings. These start with a period during which the parties are encouraged to negotiate an agreement because, if certain conditions are met, the opposition fee will be refunded — this is known as the 'cooling-off' period. The cooling-off period is set to expire 2 months from the notification of admissibility. It can be extended once by 22 months and can last up to a total of 24 months. The notice of opposition and other documents received are sent together with the notification to the applicant.

Once the cooling-off period has expired, the adversarial part of the proceedings begins. The opponent is then allowed 2 more months to submit all evidence and observations it considers necessary to make its case. After these 2 months have lapsed, and once the submitted evidence and observations (if any) have been forwarded, the applicant has 2 months to reply to the opposition.

At this stage, the applicant can file a request for proof of use, requiring the opponent to prove that any earlier marks registered for more than 5 years have been used. If such a request is filed, the applicant may wait until the opponent has adduced such proof before filing its evidence and observations. The opponent is then given the opportunity to comment on the applicant's observations.

If the applicant does not request proof of use but submits evidence and observations, the opponent is given 2 months to comment on the applicant's submissions and after these exchanges the opposition is normally ready for decision.

In some cases, it may be necessary or useful to have another exchange of observations. This may occur when the case deals with complex issues or when the opponent raises a new point that is admitted to the proceedings. In this case the applicant may be given a possibility of replying. It is then up to the examiner to decide if another round should be given to the opponent.

The Office may request the parties to restrict their observations to particular issues, permitting observations on other issues at a later point in time.

Once the parties have submitted their observations, the proceedings are closed, the file is ready for a decision on substance and the parties are informed accordingly.

When an opposition is filed against an international registration designating the EU, the references in the Guidelines to EUTM applications must be read as including international registrations designating the EU, unless indicated otherwise. The Guidelines, [Part M, International Marks](#), cover the specific details of oppositions against international registrations designating the EU.

## 2 Notice of Opposition

### 2.1 Notice of opposition in writing

#### [Article 46 EUTMR](#)

Articles [4](#) and [63\(1\)\(a\)](#) EUTMDR

Decision No [EX-20-9](#) of the Executive Director of the Office of 3 November 2020 on communication by electronic means.

The notice of opposition has to be received by the Office in written form within the opposition period, namely within 3 months from the publication of the contested EUTM application in the EUTM bulletin part A.

A notice of opposition may be filed by using the electronic form available in the User Area of the Office website. Once submitted, the electronic form will be processed automatically and a receipt will be issued for the opponent. If filed by post or courier, the receipt will be issued after the notice of opposition has been keyed into the Office's IT system.

### 2.1.1 Early oppositions against an international registration

[Article 196\(2\) EUTMR](#)

[Article 77\(3\) EUTMDR](#)

An opposition against an international registration designating the EU (IR) may be filed within a period of 3 months starting 1 month after the date of first republication. For example, if first republication is on 15/04/2016, then the opposition period starts on 15/05/2016 and ends on 15/08/2016.

For international registrations whose date of first republication falls before the entry into force, on 23/03/2016, of the amendment of [Article 196\(2\) EUTMR](#) brought about by [Regulation \(EU\) 2015/2424](#), the previous time limit applies, according to which an opposition must be filed within a period of 3 months starting 6 months after the date of first republication. For example, if first republication is on 22/03/2016, then the opposition period starts on 22/09/2016 and ends on 22/12/2016.

However, oppositions filed after the republication of the IR but prior to the start of the opposition period will be kept on hold and be deemed to have been filed on the first day of the opposition period. The opponent will be informed accordingly. If the opposition is withdrawn before that date, the opposition fee will be refunded.

### 2.1.2 Early opposition against an EUTM application

Articles [44](#) and [46](#) EUTMR

Any notice of opposition against an EUTM application received before commencement of the opposition period will be kept on hold and be deemed to have been filed on the first day of the opposition period, namely the first day after the publication of the EUTM application in Part A.1 of the EUTM Bulletin. The opponent will be informed accordingly. If the opposition is withdrawn before that date or the EUTM application is refused or withdrawn before publication, the opposition fee will be refunded.

## 2.2 Payment

For general rules on payments, refer to the Guidelines, [Part A, General Rules, Section 3, Payment of Fees, Costs and Charges](#).

### 2.2.1 Notice of opposition late, payment within the opposition period

[Article 5\(2\) EUTMDR](#)

If the payment was received by the Office within the opposition period but the notice of opposition was received late, the opposition is inadmissible. In this case the Office will

keep the opposition fee. The opponent must be notified and may comment on the finding of inadmissibility within the time limit set by the Office.

If the opponent submits convincing evidence, such as confirmation of receipt by messenger and/or delivery slips for registered mails, that proves that the notice of opposition was not late and was in fact correctly received by the Office within the 3-month opposition period, the Office must reconsider its finding and accept the opposition as having been received within the opposition period. In this case the admissibility check can continue. If the evidence submitted by the opponent does not prove that the notice of opposition was received within the opposition period or if the opponent does not reply within the set time limit, a decision ruling the opposition inadmissible has to be taken. When notifying the opponent of the decision, the applicant must be sent a copy.

### 2.2.2 Time of payment

Article [46\(3\)](#) and Article [180](#) EUTMR

[Article 5\(1\) EUTMDR](#)

The Office has to receive the full amount of the opposition fee within the opposition period. If the opposition fee was not received within the opposition period, the notice of opposition is deemed not to have been entered.

#### 2.2.2.1 Payment by bank transfer

Payments by bank transfer received after the opposition period are considered to be made within the opposition period if the opponent (i) files evidence showing that it gave the transfer order to a banking establishment within the opposition period and (ii) pays a surcharge of 10 % of the opposition fee. No surcharge will be payable if the evidence shows that the order to the bank was given no less than 10 days before the expiry of the opposition period.

#### 2.2.2.2 Payment by current account

Articles [179\(1\)](#) and [180\(1\)](#) EUTMR

Decision [EX-21-5](#) of the Executive Director of the Office of 21/07/2021 concerning methods of payment of fees and charges and determining the insignificant amount of fees and charges

If the opponent or its representative holds a current account, the payment is considered effective on the day the opposition is received.

Since a payment by current account is considered to have been made on the date of receipt of the opposition, if the notice of opposition arrived late, the payment is also late. Therefore, the opposition is deemed not to have been entered.

Failure to indicate or to correctly indicate the amount of the opposition fee does not have any negative effect on the opposition, because it is clear that the opponent wanted to pay the amount of the opposition fee.

Even if there is no express request from the opponent, the existence of a current account will be sufficient for the account to be debited. This is true regardless of whether the opposition form is used or not.

The only exception to this rule is when the holder of a current account who wishes to exclude use of the current account for a particular fee or charge informs the Office thereof in writing (e.g. indicating bank transfer).

#### Fee payment by debiting a current account held by a third party

Payment of an opposition fee by debiting a current account held by a third party requires the explicit authorisation of the holder of the current account that its account can be debited for that particular fee. In such cases the opponent must file an authorisation within the opposition period.

Payment is considered to be made on the date the Office receives the authorisation.

### 2.2.3 Consequences in the event of non-payment

[Article 99 EUTMR](#)

[Article 5\(1\) EUTMDR](#)

An opposition for which the payment is not made within the opposition period will be deemed not to have been entered and the opponent must be notified of this finding.

A copy of this letter must be sent to the applicant for information purposes at the same time.

If, within the time limit allowed, the opponent submits evidence that convinces the Office that the loss of rights was incorrect and proves that the payment was made on time, a notification has to be sent, with a copy to the applicant; the applicant will also be sent the evidence submitted by the opponent.

If an opposition is deemed not to have been entered, the opponent has the right to request a formal decision within 2 months. If it does so, the decision must be sent to both parties.

For cases in which the opposition fee has not been paid in full or has not been paid until after the opposition period, see [paragraph 6.4.1 below](#).



## 2.3 Languages and translation of the notice of opposition

[Article 146\(5\)](#), [Article 146\(6\)\(a\)](#) and [Article 146\(7\) EUTMR](#)

[Article 5\(3\) and \(4\)](#) and [Article 65 EUTMDR](#)

### 2.3.1 Language of proceedings

The notice of opposition must be filed in one of the five languages of the Office. The rules regarding the language of proceedings are explained in detail in the Guidelines, [Part A, General Rules, Section 4, Language of Proceedings](#).

According to these rules, in opposition proceedings there are cases where the opponent has a choice between two possible languages of proceedings (the first and second languages of the contested EUTM application, both being languages of the Office), and cases where there is only one possible language of proceedings (when the first language is not one of the five languages of the Office, the language of the opposition proceedings can only be the second language of the contested EUTM application).

In cases where there is a choice, the language of proceedings will be that expressly indicated by the opponent in the notice of opposition or, in the absence of an express indication, the language in which the notice of opposition was filed, provided in both cases that it is one of the possible languages of proceedings.

Where the wrong language of proceedings is chosen by the opponent, the EUTMR distinguishes between two different scenarios: where the incorrect language is a language of the Office, and where the incorrect language is one of the official languages of the European Union (but not one of the Office). Depending on which of the above applies, there are different consequences and time limits for the opponent to respect when choosing the correct language of the proceedings and submitting the translation of the notice of opposition.

- If the language chosen by the opponent is a **language of the Office**, but not one of the possible languages of the proceedings, the opposing party must produce, at its own expense, a translation of the notice of opposition into the first language, providing it is a language of the Office, or into the second language. The translation must be produced **within 1 month from the expiry of the 3-month opposition period**. The language into which the notice of opposition has been translated will then become the language of the proceedings. Where the opposing party does not submit the translation within this time limit, the opposition will be rejected as inadmissible. [Article 146\(7\) EUTMR](#) and [Article 5\(3\) and \(4\) EUTMDR](#) apply.
- If the language chosen by the opponent is **not a language of the Office**, the opposing party must produce, at its own expense, a translation of the notice of opposition into the first language, providing it is a language of the Office, or into the second language. The translation must be produced **within the 3-month opposition period**. Where the opposing party does not submit the translation within

the opposition period, the opposition will be rejected as inadmissible. [Article 146\(5\) EUTMR](#) applies as it clearly specifies that the notice of opposition must be filed in a language of the Office. If it is not filed in a language of the Office, the 1-month period to remedy the deficiency of [Article 146\(7\)](#) and [Article 5\(3\) EUTMDR](#) does not apply.

In the event that the language chosen by the opponent is not one of the possible languages of the proceedings, any correspondence issued by the Office in the opposition will be in the first language of the contested mark, providing it is a language of the Office, or in the second language if the first one is not one of the five languages of the Office.

The language requirement of the notice of opposition is an absolute admissibility requirement and will be dealt with as explained under [paragraph 2.4.1 below](#).

Concerning the use of official forms, the second sentence of [Article 146\(6\) EUTMR](#) states that when the form provided by the Office is used, it may be used in any official language of the European Union, provided that it is completed in one of the languages of the Office as far as textual elements are concerned.

Where the opponent uses the official form in a language that cannot be the language of the proceedings, all textual elements are in the wrong language and a language has been chosen that cannot be the language of the proceedings, the above principles apply: where the incorrect language chosen is a language of the Office, the opponent has 1 month to file a translation on its own motion; where the incorrect language chosen is not a language of the Office, the deficiency cannot be remedied after the expiry of the opposition period and the opposition will be deemed inadmissible.

### 2.3.2 Examples

As an illustration of what is explained in [paragraph 2.3.1 above](#), here are some examples.

1. The languages of the EUTM application are PT and EN. The opponent files an opposition in PT, choosing PT as the language of the proceedings. As the language of the proceedings has not been correctly chosen, since PT is not a language of the Office, the opponent must submit the translation of the notice of opposition into EN (the only correct language in this case) before the expiry of the opposition period, and EN will therefore become the language of the proceedings.
2. The languages of the EUTM application are BG and EN. The opponent files an opposition in BG, and in BG expressly indicates that the language of the proceedings is EN. The Office cannot accept an indication in BG that the language should be EN. As the language of the proceedings has not been correctly indicated, since BG is not a language of the Office, the opponent must submit the translation of the notice of opposition into EN (the only correct language in this case) before the expiry of the opposition period, and EN will therefore become the language of the proceedings.
3. The languages of the EUTM application are DE and EN. The opponent files an opposition in FR. As FR is a language of the Office and as the language of proceedings can be either DE or EN, the opponent must produce the translation

within 1 month of expiry of the opposition period into DE or EN, which will become the language of the proceedings.

In all of the above examples, if the opponent does not submit the translation into a correct language within the relevant time limit, the opposition will be rejected as inadmissible. However, in the above examples, if the official form had been used in PT, BG and FR respectively, but had been completed in its entirety in EN expressly indicating EN as the language of the proceedings, this would be admissible without any need for a translation into EN to be submitted. There would be no need to submit a translation of the official form if all the textual elements, and the indication of language, were in EN.

## 2.4 Admissibility check

Articles [2\(2\)](#) and [5\(3\) and \(5\)](#) EUTMDR

Once the opposition period is over, the Office checks the admissibility of any opposition received. The admissibility check covers both absolute and relative requirements.

**Absolute admissibility requirements** are the indications and elements that must be present in the notice of opposition or submitted by the opponent on their own initiative within the opposition period, as laid down in [Article 146\(5\) and \(7\) EUTMR](#) and [Article 2\(2\)\(a\) to \(c\) EUTMDR](#). If the opponent does not remedy an absolute admissibility deficiency within the opposition period on their own initiative, the opposition will be rejected as inadmissible.

**Relative admissibility requirements** are the indications and elements that, if they are not submitted within the opposition period, trigger a deficiency notice from the Office, as laid down in [Article 2\(2\)\(d\) to \(h\) EUTMDR](#). The notification gives the opponent a non-extendable time limit of 2 months to remedy the deficiency. If the opponent does not remedy a relative admissibility deficiency within the specified time limit, the Office will reject the opposition as inadmissible.

The opponent need not submit a reasoned statement or supporting evidence with the notice of opposition ([Article 2\(4\) EUTMDR](#)), but may do so later, during the adversarial stage of the proceedings ([Article 7\(1\) EUTMDR](#)) (see paragraphs [4.1](#) and [4.2](#)).

For the purposes of assessing the admissibility of the opposition, the Office must base itself solely on the content of the documents submitted by the opponent within the opposition period (21/07/2014, [R 1573/2013-4](#), OKAY / O-KEY (fig.)).

Identification elements for absolute and relative admissibility are to be looked for not only in the notice of opposition, but also in its annexes and any other documents submitted within the opposition period. The same applies where the opponent provides evidence by referring to an online source pursuant to [Article 7\(3\) EUTMDR](#).

As long as the opposition is found to be admissible for one earlier right, the parties will be notified accordingly and the proceedings will continue. The admissibility of any other earlier right will be examined later during the proceedings if necessary (for example, if

the earlier right that has been found admissible is not substantiated, see paragraph 4.2 below, or where the opposition cannot be fully upheld on the basis of that earlier right).

Any decision to reject an opposition as inadmissible will also be communicated to the EUTM applicant ([Article 5\(6\) EUTMDR](#)) but can only be appealed by the opponent.

#### 2.4.1 Absolute admissibility requirements

[Article 2\(2\)\(a\) to \(c\)](#) and [Article 5\(3\) EUTMDR](#)

[Article 94\(1\) EUTMR](#)

Absolute admissibility deficiencies can only be remedied on the opponent's initiative during the 3-month opposition period; otherwise the opposition is inadmissible. The opponent will be invited to submit comments on inadmissibility before the decision on admissibility of the opposition is taken.

##### 2.4.1.1 Identification of the contested EUTM application

[Article 2\(2\)\(a\)](#) and [Article 5\(3\) EUTMDR](#)

The mandatory elements for identifying the contested EUTM application are the application number and the name of the applicant.

If, for example, the application number indicated does not correspond to the name of the applicant indicated, the Office will decide if it can be established without any doubt which is the contested EUTM application. If the applicant's name is not indicated, it can be found in the Office's IT system.

The date of publication is an optional indication that helps to double-check the identification of the EUTM application. Even if it is missing, the EUTM application can be sufficiently identified through the other indications.

Only one EUTM application can be contested in one notice of opposition.

##### 2.4.1.2 Identification of earlier marks or rights

An opposition without an indication of the earlier mark or right or one that relies on an earlier mark or right that is not protected within the European Union is inadmissible (except for an opposition under [Article 8\(3\) EUTMR](#), see [paragraph 4.2.4.5](#)). As the earlier marks or rights relied on must be identified within the opposition period, the opposition is inadmissible to the extent the opponent relies on marks or rights that are identified after the expiry of that period.

Invoked rights that are not earlier

Articles [8\(2\)](#) and [46\(1\)](#) EUTMR

Sometimes an opposition is based on one or more marks or other rights that are not earlier than the EUTM application. Whether at least one of the rights invoked is earlier is established at the admissibility stage.

For the invoked right to be earlier it must have an application or priority date that is earlier than the filing date (or priority date if applicable) of the contested EUTM application. In the case of conflict between a national mark and an EUTM application, the hour and the minute of filing of the national mark is not relevant for determining which mark is earlier (22/03/2012, [C-190/10](#), Rizo, EU:C:2012:157). If priority has been claimed, it must also be carefully examined to what extent the list of goods and services on which the opposition is based overlaps with the list of goods and services of the mark whose priority is claimed. For further information see also the Guidelines, [Part B, Examination, Section 2, Formalities, paragraph 11](#).

When the only invoked mark is not earlier, or when all the marks invoked are not earlier, the Office will inform the opponent of the inadmissibility and invite it to comment on that issue before a decision on inadmissibility is taken.

Where the opposition is based on more than one right, one being earlier and one or more not being earlier, the Office will notify the admissibility of the opposition on the basis of the earlier one.

Earlier trade mark registrations or applications under [Article 8\(2\)\(a\) and \(b\) EUTMR](#)

Articles [2\(2\)\(b\)\(i\)](#) and [5\(3\)](#) EUTMDR

Articles [8\(1\)](#), [8\(5\)](#) and [8\(2\)\(a\) and \(b\)](#) EUTMR

These rights are European Union trade mark registrations or applications, international registrations designating the European Union, national or Benelux trade mark registrations or applications (including 'ex-European Union trade marks' for which a request for conversion has been filed) and international registrations having effect in a Member State, invoked under [Article 8\(1\) or 8\(5\) EUTMR](#).

The absolute identification elements for earlier trade mark registrations and applications are listed here.

- The registration/application number.
  - National applications deriving from the conversion of an earlier EUTM (application) are considered to come into existence as soon as a valid conversion request is submitted (see [Part E, Section 2 Conversion, 2 Conversion of EUTMs and IRs Designating the EU, 2.1 Conversion of EUTMs](#)). Such rights will be properly identified for admissibility purposes if the opponent indicates the number of the EUTM (application) under conversion and the countries for which it has requested the conversion.
- An indication of whether the earlier mark is registered or applied for.

- The Member State, including Benelux, where the earlier mark is registered/applied for or, if applicable, an indication that it is an EUTM.
  - If the Member State is not indicated in the opposition notice but a certificate is attached, it is considered that the Member State is sufficiently identified, even if the certificate is not in the language of the proceedings. A translation of the certificate should not be asked for at this stage in the proceedings. Where a certificate of an international registration is concerned it is assumed that the opposition is based on this mark in all the designated Member States and/or the Benelux countries indicated in the certificate. However, the basic registration is an independent earlier right, which may be claimed separately (for more detailed information on International Registrations, see [Part M, International marks](#)).

In the absence of the previous indications, the relevant right will be inadmissible.

The seniority claimed in an EUTM can be taken into account within the meaning of [Article 8\(2\)\(a\) EUTMR](#) provided that the proprietor of the EUTM has surrendered the earlier mark or allowed it to lapse within the meaning of [Article 39\(3\) EUTMR](#) and that this fact is proved by the opponent.

In such a case, the opponent must base its opposition on the European Union trade mark, explicitly claiming within the 3-month opposition period that the national mark continues to exist through the seniority claimed in the EUTM. A clear link must be established between the EUTM indicated and the earlier mark for which the seniority was claimed in the EUTM. Within the time limit set according to [Article 7\(1\) EUTMDR](#), the opponent must submit sufficient proof, emanating from the administration by which the national trade mark was registered, that the national mark has been surrendered or allowed to lapse according to [Article 39\(3\) EUTMR](#).

Earlier well-known marks under [Article 8\(2\)\(c\) EUTMR](#)

Articles [2\(2\)\(b\)\(i\) and \(ii\)](#) and [5\(3\)](#) EUTMDR

[Article 8\(2\)\(c\) EUTMR](#)

[Article 8\(2\)\(c\) EUTMR](#) protects well-known marks within the meaning of Article 6*bis* of the Paris Convention. This can be a registration or an application for registration, a non-registered mark, or a mark that is not registered in the territory where the well-known character is claimed (irrespective of registration in the territory of origin).

The absolute indications are:

- an indication of the Member State where the mark is claimed to be well known;
- a representation of the mark. For word marks, this is the indication of the word that makes up the mark. For figurative or other marks, the representation of the mark (in colour if applicable) as it is used and claimed to be well known must be provided. If the opposition is furthermore based on one registered trade mark, but no representation of the well-known mark is given, the Office assumes that both trade marks refer to the same sign and that the opponent claims the registered mark to be well known (17/10/2007, [R 160/2007-1](#), QUART / Quarto).

In the absence of the previous indications, the relevant right will be inadmissible.

Trade marks filed by an agent under [Article 8\(3\) EUTMR](#)

Articles [2\(2\)\(b\)\(iii\)](#) and [5\(3\)](#) EUTMDR

[Article 8\(3\) EUTMR](#)

These are contested EUTM applications in relation to which the opponent claims that the applicant, who has or had an agent or representative relationship with the opponent, applied for the mark(s) without its consent.

The absolute indications for earlier trade mark registrations/applications are:

- an indication of the territory in which the earlier trade mark is protected;
- a representation of the earlier mark (in colour if applicable);
- an indication of whether the earlier mark is registered or applied for;
- the registration/application number.

The absolute indications for earlier non-registered trade marks are:

- an indication of the territory in which the earlier trade mark is protected;
- a representation of the earlier mark (in colour if applicable).

The representation of the mark (in colour if applicable) must be given only if the proprietor's earlier mark is a non-registered mark, because in this case no registration number can be provided to clearly identify the earlier mark. For non-registered word marks, the word that makes up the mark must be indicated. For non-registered figurative or other marks, the representation of the mark as it is used and claimed by the proprietor must be provided. See also the Guidelines, [Part C, Opposition, Section 3, Unauthorised Filing by Agents of the TM Proprietor \(Article 8\(3\) EUTMR\)](#).

In the absence of the previous indications, the relevant right will be inadmissible.

Earlier non-registered marks and earlier signs used in the course of trade under [Article 8\(4\) EUTMR](#)

Articles [2\(2\)\(b\)\(iv\)](#) and [5\(3\)](#) EUTMDR

[Article 8\(4\) EUTMR](#)

This category consists of signs that are not registered and used as trade marks and of a great number of different earlier rights, such as rights to a company name, a trade name, and titles of protected literary/artistic works or the right to a sign under passing off.

The absolute indications are listed here.

- An indication of the kind or nature of the right.
  - The nature of the right determines the scope of the opposition and the applicant's defence depends on it. 'Trade name', 'company name', 'passing off', 'title of a protected literary/artistic work' are acceptable indications of the nature of rights. By contrast, general terms such as 'common law' and 'unfair competition' without an indication of the specific nature of the right are not accepted. This list is not exhaustive.



- If the opponent bases its opposition on a right that cannot be an earlier right under [Article 8\(4\) EUTMR](#), for example a copyright or a design, the opposition is admissible. However, after the proceedings have commenced, the opposition will be rejected on substance.
- An indication of the Member State where the right is claimed to exist.
- A representation of the earlier right (in colour if applicable).

In the absence of the previous indications, the relevant right will be inadmissible.

Protected designation of origin and/or geographical indications under [Article 8\(6\) EUTMR](#)

Articles [2\(2\)\(b\)\(v\)](#) and [5\(3\)](#) EUTMDR

[Article 8\(6\) EUTMR](#)

Under [Article 8\(6\) EUTMR](#), an opposition can be based on an earlier protected designation of origin or a geographical indication. The absolute indications are:

- an indication of the nature of the right, namely protected designation of origin or geographical indication;
- an indication of the territory where the protected designation of origin or geographical indication is claimed to be protected, namely the European Union or a Member State;
- a representation of the protected designation of origin or geographical indication (word only).

In the absence of the previous indications, the relevant right will be inadmissible.

#### 2.4.1.3 Identification of grounds

[Article 2\(2\)\(c\)](#) and [Article 5\(3\) EUTMDR](#)

[Article 46\(3\) EUTMR](#)

An opposition without any indication of grounds is inadmissible if this deficiency is not remedied before expiry of the opposition period. It also follows that the opposition is inadmissible to the extent the opponent relies on any further ground of opposition that is submitted after the expiry of the opposition period.

The specification of grounds should consist of a statement to the effect that the respective requirements under [Article 8 EUTMR](#) are fulfilled. Arguments and evidence are voluntary at this point in the proceedings.

In particular, the grounds are to be considered as properly indicated if one of the relevant options in the opposition form is selected or if this can be inferred from the opponent's arguments filed within the opposition period. In both cases, if it is possible to identify the grounds within the opposition period without any doubt, the opposition is admissible.



Before rejecting the opposition, a careful assessment of the entire notice of opposition and other documents submitted must be made: whether indicated in the opposition form, its annexes or its supporting documents, the grounds must be unequivocally clear in respect of each earlier right.

#### 2.4.2 Relative admissibility requirements

[Article 2\(2\)\(d\) to \(h\)](#) and [Article 5\(5\) EUTMDR](#)

Relative deficiencies are those that can be remedied after expiry of the opposition period. The Office invites the opponent to remedy the deficiency within 2 months from notification of the deficiencies. If the opponent remedies the deficiencies, the opposition is considered admissible; if not, it will be rejected on the grounds of inadmissibility.

##### 2.4.2.1 Dates

[Article 2\(2\)\(d\),\(e\)](#) and [Article 5\(5\) EUTMDR](#)

The dates to be indicated in the notice of opposition include the filing date and, where available, the registration date and priority date of the earlier mark.

This requirement applies to the following rights:

- earlier European Union or national or international trade mark applications or registrations invoked under [Article 8\(1\)\(a\) or \(b\) EUTMR](#);
- earlier marks under [Article 8\(3\) EUTMR](#) if they are registered;
- earlier marks with a reputation invoked under [Article 8\(5\) EUTMR](#)

In notices of opposition based on protected designations of origin or geographical indications, the date of application for registration or, if that date is not available, the date from which protection is granted should be indicated.

These indications can be important for eliminating possible errors when identifying the abovementioned earlier marks/signs. It is sufficient that these elements can be found in enclosed documents.

##### 2.4.2.2 Representation of earlier marks

[Article 2\(2\)\(f\)](#), [5\(5\)](#) and [63\(3\) EUTMDR](#).

The relative admissibility requirement to submit a representation of the mark under [Article 2\(2\)\(f\) EUTMDR](#) applies to earlier national or international trade mark applications or registrations invoked under [Article 8\(1\) or 8\(5\) EUTMR](#).

If no representation of the mark has been included in the notice of opposition, the opponent will be notified of the deficiency. The Office will also request a clear representation if the one submitted is incomplete or illegible. If the opponent does not

comply within the 2-month time limit given, the opposition based on that earlier right will be rejected as inadmissible.

If the mark is a word mark, the word that makes up the mark must be indicated in the notice of opposition.

If the mark is a figurative, three-dimensional / shape, or other type of mark, a representation of the mark as applied for or registered must be submitted.

If the mark is protected as a mark in colour, the representation must be submitted in colour. Even if no colour representation of such a mark is available in official publications of the competent registration authority because, at the relevant point in time, that authority was not yet publishing marks in colour, a colour representation that corresponds to the colours claimed still has to be submitted. This is because, for the purposes of **indicating** a mark in colour as the basis of an opposition, a colour representation of the mark must be submitted (not necessarily from an official source). In this regard, a representation that includes the colours in words in the language of the proceedings or generally recognised colour codes (such as Pantone, Hex, RAL, RGB or CMYK) and their distribution within the mark (for example, by using arrows that clearly indicate to which element of the mark the specific colour applies) is considered a 'colour representation'.

On the other hand, **providing evidence** of such a mark (from an official source) is a question of substantiation, which is explained in detail in [paragraph 4.2.3.6](#) (25/10/2018, [T-359/17](#), ALDI / ALDO (fig.), EU:T:2018:720, § 43-44; 04/06/2019, [C-822/18 P](#), ALDI / ALDO (fig.), EU:C:2019:466, appeal dismissed). If the notice of opposition or the documents attached to it contain an indication (available in or translated into the language of the proceedings) that the earlier mark is in colour, but are not accompanied by a representation of the mark in colour, the Office will notify this deficiency. If the opponent does not comply within the 2-month time limit given, the opposition based on that earlier right will be rejected as inadmissible.

#### 2.4.2.3 Goods and services

[Article 2\(2\)\(g\)](#) and [Article 5\(5\) EUTMDR](#)

[Article 2\(2\)\(g\) EUTMDR](#) stipulates that the notice of opposition must contain an indication of the goods and services on which the opposition is based in the language of the proceedings for each of the grounds. This applies to all types of earlier rights.

The opposition can be based on all the goods and services for which the earlier mark is registered or applied for, or on only some of the goods and services. These goods and services must be listed in the language of the proceedings.

If the goods and services on which the opposition is based are fewer than the goods and services for which the mark is registered, the goods and services on which the opposition is **not** based need not be indicated, as they are irrelevant to the proceedings.

An indication of the class number(s) or a reference to 'all goods and services for which the earlier mark is registered' is accepted as sufficient indication of the goods and services of the earlier rights on which the opposition is based, provided that a registration certificate or extract from an official source, containing the list of goods and services covered by that mark, is attached (the registration certificate or extract must either be in the language of the proceedings or be translated into the language of the proceedings or make use of national or INID codes so as to clearly identify the relevant class number(s)).

If an indication such as 'the opposition is based on all the goods in Class 9' is used and no certificate in the language of the proceedings is attached, the Office will require a specification of the goods in the language of the proceedings. An indication of this type is only acceptable when the opponent replies that it owns a registration with a description that mentions that the sign is registered for 'all goods in Class 9'.

Additionally, where the opponent indicates in the opposition form that the opposition is based on 'all goods and services for which the earlier right is registered' but then lists only 'part' of these goods and services (when compared with the registration certificate or relevant official extract attached to the opposition form) the Office will, in order to overcome the contradictory information contained in the notice of opposition, assume that the opposition is based on 'all goods and services for which the earlier right is registered'.

Even if the opponent has not indicated, or has not clearly indicated, on which goods and/or services it bases its opposition, it is sufficient if a registration certificate in the language of the proceedings is attached; it is then assumed that the opposition is based on the goods and services that appear in the certificate. However, if the certificate is in a language other than the language of the proceedings or if no certificate is attached, the deficiency must be notified.

If an opposition is based on 'all identical/similar goods and services', clarification must be requested since this wording is not sufficiently clear to identify the basis of the opposition.

For oppositions based on earlier non-registered trade marks or rights, the opponent must indicate the commercial activities in which they are used.

Specific aspects: oppositions filed against international registrations designating the EU

For admissibility purposes, with regard to oppositions filed against international registrations designating the EU, an indication of the class number(s) only in the notice of opposition is not sufficient to identify the goods and services on which the opposition is based. If the opposition is based on all or part of the goods and services for which the earlier mark(s) is/are registered/applied for, these goods and services need to be listed in the language of the opposition proceedings. This list must include all the goods or services covered by that mark or at least the relevant goods or services on which the opposition is based.

#### 2.4.2.4 Extent of opposition

##### [Article 2\(2\)\(i\) EUTMDR](#)

The opposition may contain an indication of the goods and services against which the opposition is directed; in the absence of such an indication, the opposition will be considered to be directed against all of the goods and services of the opposed mark.

If the opponent indicates that the opposition is only directed against part of the goods and services of the EUTM application, it must list these goods **clearly**.

The extent of the opposition is correctly indicated where the goods are specific goods encompassed by a broader term used in the contested specification (e.g. opposition directed against *trousers* and the EUTM application is filed for *clothing* — in this example, the only contested goods are considered to be *trousers*). However, when the opponent uses ambiguous wording, such as ‘the opposition is directed against all goods similar to ...’, when the opponent’s goods are substituted for applicant’s goods, or when any other indication given does not clearly identify the contested goods and services, the opposition will be considered to be directed against all of the goods and services of the opposed mark.

Additionally, where the opponent indicates in the opposition form that the opposition is directed against ‘part of the goods and services of the contested mark’ but then lists ‘all’ of the goods and services in the notice of opposition or in the annexes, the Office will, absent further clarification, assume that the opposition is directed against ‘all the goods and services’ in order to overcome the contradictory information contained in the notice of opposition.

#### 2.4.2.5 Earlier mark with a reputation: territorial scope of reputation

When the opponent invokes [Article 8\(5\) EUTMR](#) on the basis of a national trade mark, the Office assumes that reputation is claimed for the territory in relation to which the earlier national mark has protection.

When the opponent invokes [Article 8\(5\) EUTMR](#) on the basis of an international trade mark, the opponent will have to identify the territories for which it claims reputation for its mark. In the absence of that indication, the Office assumes that reputation is claimed for all the territories in relation to which the earlier mark has protection.

When the earlier mark is an EUTM, no indication is requested since it is considered that the reputation is claimed for the EU.

#### 2.4.2.6 Identification of the opponent

[Article 2\(2\)\(h\)\(i\) EUTMDR](#)

[Article 2\(1\)\(b\) EUTMIR](#)

For information on the identification of the opponent, see the Guidelines, [Part A, General rules, Section 5, Parties to the proceedings and professional representation, paragraph 3](#).

##### Change of owner (transfer of earlier mark) before the opposition is filed

Where the earlier mark has been transferred before the opposition is filed, a distinction has to be made between oppositions based on an earlier EUTM and oppositions based on national trade mark registrations (or applications).

##### *Oppositions based on an earlier EUTM*

An opposition based on European Union registrations or applications may be entered by the successor in title of an EUTM only if the conditions set out in [Article 20\(12\) EUTMR](#) are met, namely, only if the opponent has submitted a request for the registration of the transfer when the opposition is filed. According to [Article 20\(12\) EUTMR](#), where there are time limits to be observed vis-à-vis the Office, the successor in title may make the corresponding statements to the Office once the request for registration of the transfer has been received by the Office.

It is up to the opponent to provide this information, and it will not be checked by the Office during the admissibility check. However, if the opponent mentions in the explanation of its opposition that it is the new owner (or uses similar terms), the Office must request that the opponent indicates the date the request for registration of the transfer was sent to or received by the Office.

##### *Oppositions based on a national registration or application*

An opposition based on a national registration or application may be entered by the 'old' owner or by the successor in title, as there are different practices in the different Member States regarding the need to register the transfer in the national trade mark register in order to be able to claim rights arising from the registration.

In some cases, the opposition is filed by opponent A whereas, after a transfer of the earlier mark on which the opposition is based, the mark is owned by B. As A may still appear in the relevant register as the owner, the Office will accept the opposition as valid with A as the opponent, even though it is no longer the owner of the earlier mark.

If the opposition is filed with B as the opponent and a copy of the registration certificate shows A as the owner of the earlier mark, the opposition is accepted as admissible on the assumption that the earlier mark was transferred to B before the opposition was filed. However, entitlement to file the opposition (e.g. evidence of the transfer in the language of proceedings and/or accompanied by a translation when applicable before the opposition was filed) has to be proved within the time limit for substantiation.

#### 2.4.2.7 Indication of entitlement

[Article 46\(1\) EUTMR](#)

[Article 2\(1\) and Article 2\(2\)\(h\)\(iii\) EUTMDR](#)

##### Single opponent

The following persons are entitled to file an opposition.

- An opposition pursuant to [Article 8\(1\) or \(5\) EUTMR](#) may be filed by the **owner** of the earlier mark, or by a **licensee**, provided it is authorised by the owner.
- An opposition pursuant to [Article 8\(3\) EUTMR](#) may only be filed by the **owner** of the earlier mark.
- An opposition pursuant to [Article 8\(4\) EUTMR](#) may be filed by the **owner** of the earlier right or by a **person authorised under the applicable law** to exercise that right.
- An opposition pursuant to [Article 8\(6\) EUTMR](#) may only be filed by a **person authorised under the applicable law** to exercise the rights to an earlier geographical indication.

The opponent does not have to indicate its entitlement if it is the **owner** of the earlier mark or right on which the opposition is based. If the opponent is an **authorised licensee** or a **person authorised under the applicable law** they must submit a **statement** to that effect and **specify the basis of their entitlement** (for example, licence agreement, specific authorisation from the proprietor, specific provision of the applicable law). If the basis of the entitlement is not specified, the Office will invite the opponent to remedy the deficiency. If the deficiency is not remedied, the opposition will be rejected as inadmissible for the earlier mark or right concerned.

Where an earlier mark has more than one proprietor ('co-ownership') or where an earlier right may be exercised by more than one person, the opposition may be filed by any one of them. Therefore, it is not necessary that all co-owners or authorised persons file the opposition together. Only one of them need to file the notice of opposition to avoid unnecessary complications resulting from 'multiple opponents' scenarios, particularly where the opposition is based on more than one earlier mark or right (see below).

##### Multiple opponents

If the opposition is filed by several opponents, they may do so only if **all of them** are entitled to do so for **all** of the earlier marks or rights.

**Firstly**, each opponent's **individual entitlement** in relation to each earlier mark or right must be clarified.

In the absence of any indication of entitlement, the multiple opponents will be considered to be **co-owners**, applying the rule that only licensees and persons authorised under the applicable law need to indicate their entitlement ([Article 2\(2\)\(h\)\(iii\)](#))

[EUTMDR](#)). If assumed ownership or any other indicated entitlement is contradicted by evidence attached to or relied on in the notice of opposition (e.g. online evidence shows that one of the opponents is not an ‘owner’ of one of the earlier marks) or by the particular ground or basis of opposition (e.g. geographical indications under [Article 8\(6\)](#) have no ‘owners’; a ‘licensee’ is not entitled to invoke [Article 8\(3\) EUTMR](#)), the opponents will be invited to clarify their individual entitlement for each of the earlier marks or rights.

If the opponents fail to remedy the deficiency concerning the indication of their **individual entitlement**, the opposition will be deemed **inadmissible for the earlier marks or rights for which their entitlement has not been clarified**.

**Secondly**, the opponent’s **joint entitlement** has to be verified, namely, whether they comply with the specific requirement laid down in [Article 2\(1\) EUTMDR](#). If, based on the entitlements indicated, the opponents cannot be accepted as ‘multiple opponents’, they will be invited to remedy the deficiency (typically, to choose with which of the opponents the proceedings will continue — see below). The following are **examples** of acceptable and unacceptable scenarios of multiple opponent relationships.

*Acceptable*

<b>Earlier trade marks</b>	1	2
<b>Co-owners</b>	A/B	A/B

<b>Earlier rights</b>	1	2
<b>Authorised persons</b>	A/B	A/B

<b>Earlier trade marks</b>	1	2
<b>Owner</b>	A	A
<b>Licensee</b>	B	B

<b>Earlier trade marks</b>	1	2
<b>Owner</b>	A	B
<b>Licensee</b>	B	A

<b>Earlier trade marks</b>	1	2
<b>Owner</b>	A	A
<b>Co-owner</b>	B	(none)
<b>Licensee</b>	(none)	B

*Not acceptable*

<b>Earlier trade marks</b>	1	2
<b>Owners</b>	A	B

The opponents will be asked to indicate whether the proceedings should continue with 'A' as the sole opponent based on the first earlier mark only, or with 'B' as the sole opponent based on the second earlier mark only. The opposition will no longer be considered to be based on the earlier mark of the departing opponent.

<b>Earlier trade marks</b>	1	2
<b>Owners</b>	A/B	A

The opponents will be asked to indicate whether the proceedings should continue with 'A' as the sole opponent based on both earlier marks or with 'A' and 'B' as multiple opponents based on the first mark only. In the latter case, the opposition will no longer be considered to be based on the second earlier mark.

<b>Earlier trade marks</b>	1	2
<b>Owner</b>	A	A
<b>Licensee</b>	B	none

The opponents will be asked to indicate whether the proceedings should continue with 'A' as the sole opponent based on both earlier marks or with 'A' and 'B' as multiple opponents based on the first mark only. In the latter case, the opposition will no longer be considered to be based on the second earlier mark.

If the opponents do not remedy the deficiency concerning their **joint entitlement**, the opposition will be deemed **inadmissible in its entirety**.



#### 2.4.2.8 Professional representation

Articles [119](#) and [120](#) EUTMR

[Article 2\(2\)\(h\)\(ii\)](#) and [Article 73 EUTMDR](#)

[Article 2\(2\)\(h\)\(ii\) EUTMDR](#) provides that if the opponent has designated a representative, it must provide the name and business address of the representative in accordance with [Article 2\(1\)\(e\) EUTMIR](#).

If the opponent is obliged to be represented under [Article 119 EUTMR](#), failure to appoint a representative, or failure to indicate the name or business address of the representative, constitutes a relative admissibility deficiency. The Office will invite the opponent to appoint a representative and/or to indicate the name and address of the representative, failing which the opposition will be rejected as inadmissible.

For further details on professional representatives, including the requirement of non-EEA-based opponents to appoint a representative, communication with the professional representative and the 'common representative', see the Guidelines, [Part A, General Rules, Section 5, Parties to the Proceedings and Professional Representation, paragraphs 1, 5 and 6](#).

#### 2.4.2.9 Signature

[Article 63\(1\)\(a\) EUTMDR](#)

A notice of opposition must be signed by the opponent or, if it is submitted by a representative, by the representative.

If a notice of opposition is filed by electronic means, the indication of the name of the sender is deemed equivalent to a signature.

For further details on signatures, see the Guidelines, [Part A, General Rules, Section 1, Means of Communication, Time Limits, paragraph 3.1.4](#).

#### 2.4.2.10 Relative admissibility requirements: sanctions

[Article 5\(5\) EUTMDR](#)

If relative admissibility requirements are missing or not complied with, the opponent or its representative is given 2 months to remedy the deficiency. This time limit cannot be extended.

If the deficiency is not remedied in time, the opposition must be rejected as inadmissible or, if the deficiency concerns some of the earlier rights, the opponent will be notified that the opposition is admissible but that the earlier rights concerned cannot be taken into account.

## **2.5 Notification of the admissibility of the opposition and the commencement of the adversarial part of the procedure**

Articles [5](#) and [7](#) and Articles [6\(1\)](#) and [8\(2\) and \(9\)](#) EUTMDR

Decision No [EX-20-9](#) of the Executive Director of the Office of 3 November 2020 on communication by electronic means

The Office notifies the parties when the opposition has been found admissible. That notification constitutes a decision (18/10/2012, [C-402/11 P](#), Redtube, EU:C:2012:649, § 42-53). However, as it is a decision that does not terminate proceedings, it may only be appealed together with the final decision on the case (Article 66(2) EUTMR). Consequently, the Office is bound by this decision and may only revoke it, provided that the requirements of Article 103 EUTMR for the revocation of decisions are met.

By the same notification, the Office informs the parties that the adversarial part of the proceedings is deemed to commence 2 months after receipt of the notification. The notification will also set the time limit for the opponent to present the facts, evidence and arguments in support of its opposition, as well as the time limit for the applicant to submit its observations in reply.

In practice, rather than setting separate 2-month time limits (2 months for the cooling-off period, 2 months for completing the opposition, 2 months for replying), the opponent's time limit to complete the opposition will be set at 4 months, while the applicant's time limit to reply to the opposition will be set at 6 months, from the date of the notification. Therefore, opponents should be aware that the time limit for completing the opposition is not 2 months after expiry of the cooling-off period, but 4 months from the date of notification. Likewise, applicants should be aware that the time limit to reply to the notice of opposition is not 2 months after expiry of the opponent's time limit, but 6 months from the date of notification. In any event, the Office indicates in the notification the exact dates to be observed by the parties.

Once the opponent has completed its opposition, any time after notification and before expiry of the 4 months available to it, the additional material will be forwarded to the applicant without any change in the time limit available for responding to the opposition. However, if the additional material arrives at the Office without sufficient time to forward it to the applicant within the time limit set for the opponent, the additional material will be forwarded to the applicant with a new time limit of 2 months set for replying to the opposition. This separately set 2-month time limit will run from the date of receipt of the notification of the additional material in order to ensure that the applicant always has a full 2 months to prepare its reply.

In the case of different means of communication with the parties, the time limits set in the notification on the commencement of the adversarial part of the proceedings are set according to the 'slower' means of communication. Therefore, if the Office's notification is sent by post or courier to one of the parties but by electronic means to the other, the latter will also be granted the 10 additional days to which the former party

is entitled (instead of the 5 additional days due for communication by electronic means), so that the time limits set for the commencement of the adversarial part of the proceedings coincide for both parties. For more information on communication with the Office, please refer to the Guidelines, [Part A, General Rules, Section 1, Means of Communication, Time Limits](#).

Whenever the opposition is based on an earlier trade mark registered or applied for in colour, the Office will ensure that the applicant receives the colour representation.

### **3 Cooling-off Period**

#### **3.1 Setting the cooling-off period**

[Article 6\(1\) EUTMDR](#)

When the opposition is found admissible, the Office sends a notification to the parties to that effect, also informing them that the adversarial part of the proceedings is deemed to commence 2 months after receipt of the notification.

This 2-month period serves as a so-called ‘cooling-off’ period before commencement of the adversarial part of the proceedings. During this period, the parties are encouraged to negotiate an agreement in order to settle the opposition amicably. If certain conditions are met, the opposition fee will be refunded (see paragraphs [6.2.1.2](#) and [6.2.2.1](#)).

#### **3.2 Extension of the cooling-off period**

[Article 146\(5\) to \(7\) and \(9\) EUTMR](#)

[Article 6\(1\) EUTMDR](#)

The cooling-off period may be extended up to a total of 24 months if both parties submit requests for an extension before the period expires. The Office will grant an extension of 22 months, irrespective of what length of extension is requested.

It is not possible to circumvent the limitation of the cooling-off period to 24 months by jointly requesting a suspension for negotiations. Such a suspension may be requested after expiry of the cooling-off period.

To extend the cooling-off period the following is necessary.

- A signed request from both parties. This may take the form of either two separate requests or one joint request. It is not necessary to state a reason for the extension.
- The request must be in the language of the proceedings. Alternatively, the request can be filed in one of the Office languages. However, a translation must be filed on

the parties' own initiative within 1 month of filing. The Office does not send any communication requesting a translation of the request for extension.

- The request must be filed before expiry of the cooling-off period. Any request filed after expiry of the cooling-off period will have to be rejected. If one party files the request within but the other after expiry of the cooling-off period, the extension is also to be refused.

The extension of the cooling-off period must be differentiated from requests for extension of a time limit or a suspension. In the event that the request for extension is inadmissible because it has been filed late or because the cooling-off period had already been extended, it will be treated as a request for suspension provided that the conditions of such a request are fulfilled.

The extension is granted for a period of 24 months from the date of the start of the cooling-off period. This procedure avoids multiple extensions and at the same time leaves the parties maximum freedom to decide when they want to continue with the adversarial stage of the proceedings.

Any party can then bring the extended cooling-off period to an end (opt out) by expressly indicating this in writing.

It is immaterial whether the other party agrees with this or not.

When one of the parties opts out before expiry of the extended cooling-off period, the Office will confirm this to both parties and set the cooling-off period to expire 2 weeks after the said notification. The adversarial part of the proceedings will commence the day after. The same notification will notify new time limits for substantiation of the opposition and the applicant's reply, which will be 2 and 4 months, respectively, from the end of the cooling-off period.

Opting out is irrevocable. Opting out during the last month before commencement of the proceedings will not be accepted.

## 4 Adversarial Stage

### 4.1 Completion of the opposition

Within 2 months of expiry of the cooling-off period, the opponent may submit additional facts, evidence and arguments in support of its opposition.

Within the same time limit, the opponent must prove the existence, validity and scope of protection of the earlier rights it invoked, and submit proof of its entitlement to file the opposition.

The request to the opponent is a **general invitation** to complete the file within the meaning of [Article 7 EUTMDR](#). The Office will **not** indicate the nature and type of material necessary for completing the file (see expressly [Article 8\(9\)](#), second sentence, EUTMDR). Rather, it will be for the opponent to decide what it wishes to submit.

## 4.2 Substantiation

[Article 46 EUTMR](#)

[Article 7](#) and [Article 8\(1\)](#) EUTMDR

Substantiation is defined by [Article 7\(2\) EUTMDR](#) and refers to the proof of existence, validity and scope of protection of the earlier mark(s) or right(s), and the proof of entitlement to file the opposition.

After the parties have been notified of the admissibility of the opposition, the opponent has 2 months from the end of the cooling-off period to complete its file. In particular, the opponent must prove the existence, validity and scope of protection of the earlier rights invoked and its entitlement to file the opposition. Where relevant for the opposition, the opponent must also submit evidence of reputation, enhanced distinctiveness or any other aspect affecting the scope of protection of its earlier right(s).

The opponent's submission of facts and arguments in support of the opposition as well as the evidence of filing or registration of the earlier rights or the applicable national law must be in the language of the proceedings or accompanied by a translation. The translation must be submitted within the time limit for submitting the original, that is, within the time limit for substantiation. A translation must **accompany** the evidence in the original language; a translation alone is not considered sufficient. Any other evidence not in the language of the proceedings needs to be translated only at the Office's request. For further details see [paragraph 4.3.1](#) below.

Where evidence concerning the filing or registration of the earlier rights or concerning the contents of the relevant national law is accessible online from a source recognised by the Office, the opponent may formally declare to the Office that it relies on such evidence. The Office will not check on its own initiative the substantiation of any rights online where the opponent has not expressly and unconditionally declared its intention to rely on online evidence.

It is noted that, even if the opponent formally declares that online evidence may be relied on, it is the opponent's obligation to check that the online sources reflect the most accurate and up-to-date relevant information. Moreover, in the event that the opponent, after such a declaration, still submits physical evidence without formally revoking its previous declaration, and there is a contradiction between the online evidence and the physical evidence, the most recent up-to-date evidence will apply.

A declaration may be introduced by the opposing party at any time before expiry of the time limit of substantiation. In the absence of any formal declaration (including when such declaration has been withdrawn), the opposition should be rejected as non-substantiated if no physical evidence is presented in due time.

If the opponent has not proven the existence of at least one earlier right, the opposition will be refused as unfounded.

If the earlier right that has been found admissible is not substantiated at the substantiation stage and there is another earlier right that is substantiated, the absolute admissibility requirements for that earlier right will be checked.

In relation to the submission of supporting documents, see the Guidelines, [Part A, General Rules, Section 1, Means of Communication, Time Limits](#).

#### 4.2.1 EUTMs and EUTM applications

If the earlier mark or application is an EUTM, the opponent does not have to submit any documents as far as the existence and validity of the EUTM (application) is concerned. The examination of the substantiation will be done *ex officio* with respect to the data contained in the Office's database.

#### 4.2.2 Converted EUTMs and EUTM applications

<a href="#">Article 139(1) EUTMR</a>
--------------------------------------

This section will deal only with specific aspects of conversion in opposition proceedings. For further information on conversion, see the Guidelines, [Part E, Register Operations, Section 2, Conversion](#).

##### 4.2.2.1 Opposition based on EUTM (application) (to be) converted

National applications deriving from the conversion of an earlier EUTM or EUTM application are considered to come into existence as soon as a valid conversion request is submitted. Such rights will be properly substantiated under [Article 7\(2\) EUTMDR](#) if the opponent indicates the number of the EUTM (or EUTM application) under conversion and the countries for which it has requested conversion.

##### 4.2.2.2 Opposition based on an EUTM (application) that is subsequently converted

When, during opposition proceedings, the EUTM application (or EUTM) on which the opposition is based ceases to exist (or the list of goods and services is restricted), and a request for conversion is submitted, the proceedings can continue. This is because national trade mark registrations resulting from a conversion of an EUTM application can constitute the basis of the opposition procedure originally made on the basis of that EUTM application (15/07/2008, [R 1313/2006-G](#), CARDIVA (fig.) / CARDIMA (fig.)).

In such a case, the Office will request the opponent in writing to inform the Office whether it maintains the opposition in view of the withdrawal, surrender or rejection of the earlier EUTM application(s) or registration(s) and whether it intends to rely on the national applications that result from the conversion of the earlier EUTM. If the opponent does not inform the Office within the established time limit that it wishes to rely on the national applications, the opposition will be rejected as unfounded.

Evidence of the existence of the earlier national applications must be submitted by the opponent as soon as it becomes available.

#### 4.2.3 Trade mark registrations or applications that are not EUTMs

##### [Article 7\(2\)\(a\)\(i\) and \(ii\) EUTMDR](#)

To substantiate an earlier trade mark application or registration, the opponent must provide the Office with evidence of its filing or registration. The Office accepts as evidence of the filing or registration of earlier marks the following documents:

- certificates issued by the competent registration authorities;
- extracts from the official databases of the competent registration authorities; and
- extracts from the official bulletins of the competent registration authorities.

As mentioned above, the opponent may instead ask the Office to access the necessary information for this trade mark from the relevant online official database (see [paragraph 4.2.3.2 below](#)).

##### 4.2.3.1 Certificates issued by the appropriate official body

Any registration certificate or the most recent renewal certificate showing the validity of the earlier mark beyond the time limit that was given to the opponent to substantiate its opposition, whether issued by a national office or by WIPO (if it concerns an international registration), constitutes valid evidence. However, a renewal certificate is not sufficient on its own if it does not contain all the necessary data that determines the scope of protection of the earlier mark. For further requirements relating to evidence of renewal, see [paragraph 4.2.3.4 below](#).

If the opposition is based on an application, the opponent must submit evidence that the application was filed at the national office or that an international application was filed with WIPO. Once the earlier application has proceeded to registration, the opponent must submit evidence of registration. If, after the adversarial part of the proceedings, the opponent submits evidence that the national application in fact proceeded to registration before the time limit set in [Article 7\(1\) EUTMDR](#), the earlier mark will be rejected as unfounded under [Article 8\(7\) EUTMDR](#). An application certificate is not sufficient to prove that the trade mark has been registered. In other words, it cannot serve to prove the existence of a trade mark registration.

Certificates have to be checked carefully since, in some cases, there are only a few differences between an application form and the registration certificate.

##### 4.2.3.2 Extracts from official databases

The Office accepts, as evidence of the filing or registration of **national marks**, extracts from the official online databases of the competent registration authorities of Member States and, as evidence of **international registrations**, extracts from WIPO's Madrid Monitor database. Excerpts from unofficial databases are not acceptable.



Furthermore, the Office accepts, as evidence for **both national marks and international registrations**, extracts obtained through the Office's TMview portal (<https://www.tmdn.org/tmview/welcome>). Extracts generated through TMview reflect the information obtained **directly** from the competent registration authorities and therefore, qualify as documents equivalent to registration certificates from the competent registration authorities within the meaning of [Article 7\(2\)\(a\) EUTMDR](#) (by analogy, 06/12/2018, [T-848/16](#), V (fig.) / V (fig.) et al., EU:T:2018:884, § 59-61, 70).

While the abovementioned database extracts can be obtained and annexed to the opponent's submission, it is more convenient to refer to the relevant online source pursuant to [Article 7\(3\) EUTMDR](#). Any general reference to any of the abovementioned official online databases is acceptable; a direct link to the online source is not required. For opponents using the Office's opposition e-filing form, a claim to substantiate the marks by reference to the relevant official online database (through TMview) is set by default.

Opponents must carefully check that the relevant official online database is up to date and contains all the relevant information necessary to prove the validity and scope of protection of the earlier mark invoked in the opposition. When the extract from an official database or the database accessed online does not contain all the information required, the opponent must supplement it with other documents from an official source that show the missing information. Some examples of this situation are shown below.

- Database extracts sometimes do not contain the list of goods and/or services; in such cases, the opponent must submit an additional document (e.g. a publication in the official bulletin) showing the list of goods and services.
- For figurative marks, database extracts sometimes show the image on a separate page. Consequently, when opponents file an extract as evidence for a figurative mark, they must ensure that the representation of the mark appears on the same page. If it does not, an additional document/page showing the image must be filed. This can be from the database itself (which reproduces the image on a separate page that, when printed or saved as a PDF, for example, includes an identification of the source) or from another official source (such as its publication in the official bulletin). Copying the image from the database and including it electronically or otherwise in the notice of opposition form is not sufficient.
- When English is the language of the proceedings, and where the national office also provides an English version of the trade mark extract, no translation would in principle, be necessary. However, as regards the list of goods and/or services, where the extract itself only gives the class headings along with an indication that this reference to the class heading does not necessarily reflect the goods and/or services protected under the trade mark, the opponent must always file the original list in the original language (from an official source) and, where the list does not consist of a class heading, an accurate translation into English. Such translations are also required if the opponent relies on evidence accessible online from a source recognised by the Office if such evidence or part of it (especially the list of goods and services) is not in the language of the proceedings.



#### 4.2.3.3 Extracts from official bulletins of the relevant national trade mark offices and WIPO

In all Member States the trade mark application and/or registration is published in an official bulletin. Copies of the publication are accepted as long as the document (or the accompanying observations of the opponent) indicates the origin of the publication. If this indication is missing, the evidence is insufficient to prove the validity of the mark.

Furthermore, a copy of the publication of the application is not sufficient to prove that the trade mark has been registered. In other words, it cannot serve to prove the existence of a trade mark registration.

The Office accepts the first WIPO publication of the international registration as sufficient evidence of registration although, once registered, it can still be refused by national offices during the following 12 to 18 months. The Office will invite the opponent to submit evidence of grant of protection of the international registration (where online substantiation was not claimed) only if (i) the applicant contests the protection of the mark in question in a given territory or for certain goods and services or (ii) the Office intends to uphold the opposition on the basis of the international registration (or its particular territorial extension). Failure to provide such evidence will result in the international registration (or its particular territorial extension) being deemed not substantiated.

#### 4.2.3.4 Evidence of renewal

Trade marks are registered for a period of 10 years from the date of filing of the application; registration may be renewed for further 10-year periods ([Article 48 of Directive \(EU\) 2015/2436](#), as implemented in the respective national legislation).

If the registration is due to expire before the expiry of the time limit for substantiation, the opponent must file a renewal certificate or equivalent document in order to prove that the term of protection of the trade mark extends **beyond** this time limit or any extension given to substantiate its opposition. Such information must be accessible from a source recognised by the Office if the opponent relied on it. What counts is the date on which the registration would expire, and not the possibility of renewing the mark within the 6-month grace period under the Paris Convention.

When an earlier right on which the opposition is based reaches the end of protection after expiry of the time limit set by the Office to substantiate the opposition, the opposition is not automatically rejected in the absence of further communications or proof from the opponent. Rather a communication is issued to the opponent in which it is invited to submit evidence of renewal, which is then communicated to the applicant (05/05/2015, [T-715/13](#), Castello (fig.) / Castelló y Juan S.A. (fig.) et al., EU:T:2015:256, § 68 et seq.).

If there is no proper evidence of renewal, the opposition based on that earlier right will be rejected as not substantiated.

#### 4.2.3.5 Entitlement to file the opposition

[Article 46\(1\)\(a\) EUTMR](#)

[Article 2\(2\)\(h\)\(iii\)](#) and [Article 7\(2\) EUTMDR](#)

The opponent must submit evidence concerning its entitlement as indicated in the notice of opposition (see [paragraph 2.4.2.6 above](#)).

##### Single opponent

If the opposition is filed with 'B' as the opponent and the evidence shows 'A' as the **owner** of the earlier mark, the opposition will be rejected as not substantiated, unless the opponent has submitted evidence of the transfer and, if already available, the registration of the transfer in the relevant register, or the opponent has shown that 'A' and 'B' are the same legal entity, which has merely changed its name. A difference in the legal form may, depending on the jurisdiction, indicate different legal entities.

If the opponent is a **licensee** of the trade mark proprietor, the extract of the registration will normally show when a licence has been registered. However, some Member States do not record licences in their registers. In all cases, it is up to the opponent to demonstrate that it is a licensee and also that it is authorised by the trade mark owner to file an opposition. This authorisation cannot be presumed from the licensee status (16/05/2019, [T-354/18](#), SKYFi /SKY et al., EU:T:2019:33, § 21-26). There are no restrictions on what evidence can be submitted to support such an authorisation: for example, any express authorisation on behalf of the trade mark proprietor, such as the licence contract, is deemed sufficient, so long as it contains indications concerning the authorisation to file the opposition.

According to Articles [25](#), [26](#) and [29](#) EUTMR, the Office registers and publishes licences for EUTMs (see the Guidelines, [Part E, Register Operations, Section 3, EUTMs and RCDs as Objects of Property, Chapter 2, Licences, Rights in Rem, Levies of Execution, Insolvency Proceedings, Entitlement Proceedings or Similar Proceedings](#)). If the earlier mark is an EUTM, the registration of the licence in itself constitutes sufficient proof of the opponent's licensee status. On the other hand, the opponent will still have to submit evidence to prove that it is authorised to file the opposition. If the opponent's authorisation to file the opposition can be proved on the basis of a document previously submitted to the Office, pursuant to [Article 25\(5\) EUTMR](#), the opponent is not required to submit the same document in oppositions it subsequently files. Nevertheless, the opponent must specifically rely on and clearly identify the document and the provision that proves its authorisation to file the opposition (registration number of the licence, date and title of the document, number of the relevant clause, etc). Once identified, that document will be included in the case file and forwarded to the applicant for observations.

##### Multiple opponents

Multiple opponents are required to prove their individual entitlement to each of the earlier marks or rights relied on in the notice of opposition. If one of them fails to prove

its entitlement in relation to any of the earlier marks or rights, the opposition will be rejected as non-substantiated in relation to this opponent. The opposition will continue with the other opponent and its earlier marks or rights.

For example, opponent 'A' has indicated and proves that it owns both earlier marks. Opponent 'B' has indicated that it is co-owner of the first earlier mark and licensee for the second. It proves co-ownership of the first earlier mark, but fails to submit evidence of its licensee status for the second one. As opponent 'B' has failed to substantiate its entitlement in relation to one of the earlier marks, the opposition will be rejected in relation to opponent 'B' for all its earlier marks. This is because the opponents no longer fulfil the requirement of 'multiple opponents' within the meaning of [Article 2\(1\) EUTMDR](#) (see [paragraph 2.4.2.6 above](#)). Nevertheless, the opposition may continue with opponent 'A' and its earlier marks.

#### 4.2.3.6 Verification of the evidence

The Office verifies that the trade mark particulars **claimed** in the notice of opposition are **reflected** in the **evidence** submitted, as an official document originating from the competent registration authority, or in the evidence accessible online from a source recognised by the Office if the opponent relied on that.

The following details of the evidence will be checked <sup>(37)</sup>:

- the issuing authority;
- the filing [210] and/or registration numbers [111] (in certain countries these are, or were, different);
- the territorial extent for international registrations (i.e. in which countries the mark is protected and for what goods and services);
- the filing [220], priority [300] and registration dates [151] (in certain countries, e.g. France, the filing and registration dates found on the certificate are the same);
- the representation of the sign [531, 540, 541, 546, 554, 556, 557, 571, 591].

If the earlier mark is in colour, the opponent must submit evidence originating from an official source that contains a reproduction of the mark in colour.

If the opponent has indicated in the notice of opposition that the earlier mark is in colour, but submits evidence showing a black and white representation of the mark, the opposition based on that earlier right will be rejected as not substantiated (25/10/2018, [T-359/17](#), ALDI / ALDO (fig.), EU:T:2018:720, § 45; 04/06/2019, [C-822/18 P](#), ALDI / ALDO (fig.), EU:C:2019:466, appeal dismissed; 27/03/2019, [T-265/18](#), Formata (fig.) / Formata (fig.) et al., EU:T:2019:197, § 48-53).

The **only exception** is where a colour representation of the mark is not available in official publications of the competent registration authority because, at the relevant point in time, that authority was not yet publishing marks in colour. This is typically the case where the official online evidence contains a black and white representation of the mark accompanied by a colour claim indicating the colours in words. In such a case, notwithstanding the black and white representation of the mark, it will be accepted as

---

<sup>37</sup> The numbers in square brackets stand for standard INID codes (see in [paragraph 4.3.1](#)).

proof of a mark in colour as long as the colour indications (available in or translated into the language of proceedings) correspond to the colours of the mark indicated in the notice of opposition. In the rare situation where the official online evidence contains a black and white representation of the mark accompanied by a colour claim in general terms (e.g. 'colours claimed') but no indication of the colours in words, this will also be accepted (so long as this claim is available in or translated into the language of proceedings).

The above exception does not cover the situation where what is available in official publications of the relevant registration authority is not a colour representation as such, but a **representation that includes the colours in words and their distribution within the mark** (e.g. by using arrows that clearly indicate to which element of the mark the specific colour applies). Such a representation, even if technically black and white, will be considered a 'colour representation', and the opponent is required to provide a translation of the colour indications into the language of proceedings. The indication of generally recognised colour codes (e.g. Pantone, Hex, RAL, RGB or CMYK) is considered equivalent to the indication of the colours in words in the language of the proceedings. Indications within the representation regarding the colours and their distribution will not be considered to be part of the representation as such, but as elements that affect the scope of protection of the mark.

If the opponent has provided no indication in the notice of opposition that the earlier mark is in colour, but submits evidence showing a mark in colour, the opposition based on that earlier right will be rejected as not substantiated.

- The goods and services covered [511].
- The expiry date of the registration (if given).
- The owner [731, 732].
- Other entries in the register affecting the legal or procedural status or the scope of protection of the mark (e.g. restrictions, renewals, transfers, pending actions, the fact that the mark was registered due to acquired distinctiveness through use, etc.).

#### 4.2.4 Substantiation of other grounds and basis of opposition

##### 4.2.4.1 Well-known marks

[Article 8\(2\)\(c\)](#) and [Article 46\(1\)\(a\) EUTMR](#)

[Article 7\(2\)\(b\) EUTMDR](#)

An earlier well-known mark is a trade mark that is well known in a Member State, in the sense in which the words 'well known' are used in Article 6*bis* of the Paris Convention. Such a mark may be non-registered, but it may also be registered.

The opponent needs to demonstrate that it is the owner of an earlier trade mark that has become well known, in the relevant territory, for the goods and services on which the opposition is based. In order to substantiate its mark, it will have to submit evidence of the mark being well known.

If the opponent invokes a registered trade mark and claims the same mark in the same country as a well-known mark, this will in general be taken as an additional claim that its registered mark has acquired a high degree of distinctiveness by use.

It is very common for opponents to confuse ‘well-known’ marks with ‘marks with a reputation’ under [Article 8\(5\) EUTMR](#). Depending on the ground of opposition that is indicated, the case will have to be considered under [Article 8\(2\)\(c\)](#) and/or [Article 8\(5\) EUTMR](#). See also the Guidelines, [Part C, Opposition, Section 5, Trade Marks with Reputation \(Article 8\(5\) EUTMR\)](#).

#### 4.2.4.2 Marks with reputation

[Article 8\(5\)](#) and [Article 46\(1\)\(a\)](#) EUTMR

[Article 7\(2\)\(f\)](#) EUTMDR

An opposition under [Article 8\(5\) EUTMR](#) is based on an earlier trade mark that has a reputation.

The earlier trade mark in these cases is a registered trade mark. The opponent therefore has to submit registration certificates, etc. or rely on online evidence as set out above.

In order to make its case under [Article 8\(5\) EUTMR](#), the opponent has to submit evidence of reputation. In addition, the opponent has either to allege and demonstrate that use of the mark that is the subject matter of the contested EUTM application would take unfair advantage of, or be detrimental to, the distinctive character or the repute of the earlier trade mark, or to indicate that this is probable in the ordinary course of events.

For more details, see the Guidelines, [Part C, Opposition, Section 5, Trade marks with reputation \(Article 8\(5\) EUTMR\)](#).

#### 4.2.4.3 Non-registered trade mark or another sign used in the course of trade

[Article 8\(4\)](#) and [Article 46\(1\)\(c\)](#) EUTMR

[Article 7\(2\)\(d\)](#) EUTMDR

Oppositions under [Article 8\(4\) EUTMR](#) are based on earlier non-registered trade marks or other signs used in the course of trade governed by the applicable law invoked.

The opponent must specify the provisions of the applicable law it intends to rely on. If the law invoked is national law, it must also provide the contents of that law by adducing official publications of the relevant provisions or jurisprudence.

The opponent must then prove that it fulfils the conditions of **acquisition** and **scope of protection** of the applicable law invoked. In particular, the opponent must submit evidence of the existence and scope of protection of the earlier right and must prove

that it owns or is authorised under the applicable law to exercise the right. In the case of non-registered rights, the opponent must submit evidence of acquisition of protection through use in accordance with the standard of use required by the applicable law. In the case of registered rights (e.g. company names), evidence of registration is required. The opponent must further show that it may prohibit the use of a subsequent trade mark pursuant to the applicable law.

Finally, the opponent must submit evidence of use of the sign in the course of trade of more than mere local significance.

Where the evidence concerning the filing or registration of the sign claimed or the evidence concerning the content of the relevant national law is accessible **online from a source recognised by the Office**, the opponent may provide such evidence by making a reference to that source. To prove the existence of **registered rights**, the Office will accept any reference to an online database of the competent registration authority which is publicly accessible and free of charge, as long as the search environment is in the language of the proceedings.

To prove the **content of national law**, a reference to any online database will be accepted to the extent that it provides official legal text originating from the government or official body of the Member State concerned, is publicly accessible, free of charge and its search environment is in the language of the proceedings. In that regard, the WIPO Lex database (available at [wipolex.wipo.int](http://wipolex.wipo.int)) is a useful source as it compiles official texts for intellectual property legislation in the original language received from the Member States concerned or from other verified sources (see the Guidelines, [Part C, Opposition, Section 4, Non-registered trade marks and other signs used in the course of trade \(Article 8\(4\) EUTMR\), paragraph 4.2.1](#)), provided that the search environment coincides with the language of the proceedings.

Furthermore, if the original text of the law is not in the language of the proceedings, its translation must also be available at the indicated online source, or should be submitted separately within the time limit for substantiation of the opposition (see [paragraph 4.3.1.1](#)).

For more details, see the Guidelines, [Part C, Opposition, Section 4, Non-registered trade marks and other signs used in the course of trade \(Article 8\(4\) EUTMR\)](#).

#### 4.2.4.4 Geographical indications

[Article 8\(6\)](#) and [Article 46\(1\)\(d\)](#) EUTMR

[Article 7\(2\)\(e\)](#) EUTMDR

Oppositions under Article 8(6) EUTMR are based on earlier geographical indications and designations of origin (GIs) governed by the applicable law invoked.

To substantiate these rights, the opponent must provide the Office with evidence of the existence and scope of protection of the GI invoked and must prove that it is authorised

under the applicable law to exercise the rights arising from the GI. It must further show that it may prohibit the use of a subsequent trade mark.

To prove the GI's existence and scope of protection, the opponent must submit pertinent documents emanating from the competent authority proving that the GI in question has been applied for, registered or granted (if it was granted through administrative means other than registration). The evidence must prove all the particulars of the GI, including:

- the protected name;
- that it is protected as a GI;
- the specific goods covered by the protection;
- that it existed before the contested mark's priority date;
- proof of entitlement, namely, proof that the applicable law confers on the beneficiary of the GI a direct right of action against unauthorised use.

The opponent may submit this evidence by referring to an online database of the competent authority which is publicly accessible and free of charge, as long as the search environment is in the language of the proceedings. For GIs protected in the European Union (including third-country GIs protected at EU level through bilateral and multilateral agreements), it is sufficient to refer to the Office's [Glview](#) portal. Glview reflects information obtained directly from the European Commission and, therefore, qualifies as an official source (see paragraph [4.2.3.2](#) ). It is the opponent's responsibility to check that the online source referred to contains all the necessary information and is up to date, and if not, submit additional evidence from an official source completing the missing information. If, for example, the database does not provide sufficient information on the opponent's entitlement to exercise the rights arising from the GI, further documents must be submitted, such as national legislative instruments conferring on the opponent the right to enforce the GI against unlawful use.

Furthermore, to prove that it is entitled to prohibit use of a subsequent trade mark under the relevant law, the opponent must specify the provisions of the applicable law it intends to rely on. If the law invoked is national law, it must also provide its contents by adducing official publications of the relevant provisions or jurisprudence, or by referring to an online source recognised by the Office (see paragraph [4.2.4.3](#) ). The opponent must also prove that the case fulfils all the conditions of the scope of protection under the relevant provisions.

For more details, see the Guidelines, [Part C, Opposition, Section 6, Geographical indications \(Article 8\(6\) EUTMR\)](#).



#### 4.2.4.5 Mark filed by an agent or representative

[Article 8\(3\)](#) and [Article 46\(1\)\(b\)](#) EUTMR

[Article 7\(2\)\(c\)](#) EUTMDR

This concerns the case where an agent or representative of the proprietor of a trade mark applies for registration of that trade mark at the Office. The proprietor can oppose the application of the disloyal applicant.

The opponent has to prove its ownership of the trade mark and the time of acquisition of that mark. As the trade mark can be either a registered trade mark or a non-registered trade mark, the opponent may submit either evidence of registration anywhere in the world or evidence of acquisition of rights through use. The opponent also has to submit evidence of an agent-representative relationship.

For more details, see the Guidelines, [Part C, Opposition, Section 3, Unauthorised filing by agents of the TM proprietor \(Article 8\(3\) EUTMR\)](#).

#### 4.2.5 Non-compliance with the substantiation requirements

[Article 46\(4\)](#) EUTMR

[Article 7](#) and [Article 8\(1\) and \(7\)](#) EUTMDR

The Office sets the opponent a time limit of **2 months**, starting on the date when the adversarial part of the proceedings is deemed to commence, to complete the opposition by submitting facts, evidence and arguments in support ('substantiation time limit'). This time limit can be extended pursuant to [Article 68 EUTMDR](#) or, if missed, the opponent can apply for a reinstatement into the missed time limit subject to the conditions of [Article 104 EUTMR](#) (*restitutio in integrum*) or [Article 105 EUTMR](#) (continuation of proceedings).

[Article 8\(1\) EUTMDR](#) provides that if the opponent has **not provided any evidence** by the time of expiry of the substantiation time limit, or the evidence provided is **manifestly irrelevant** or **manifestly insufficient** to meet the requirements laid down in Article 7(2) EUTMDR for any of the earlier rights, the opposition will be rejected as unfounded.

If none of the earlier rights on which the opposition is based has been substantiated, the Office **closes the adversarial part** of the proceedings without inviting the applicant to submit observations in reply. The Office is not required to inform the opponent what facts or evidence could have been submitted (17/06/2008, [T-420/03](#), BoomerangTV, EU:T:2008:203, § 76). Subsequently, the opposition is rejected pursuant to Article 8(1) EUTMDR.

It follows that where the opponent has failed to submit **any evidence at all**, the opposition will be rejected. It must be deemed that no evidence has been submitted if



the evidence is not accompanied by a translation into the language of the proceedings, as such non-translated evidence cannot be taken into account pursuant to the last sentence of [Article 7\(4\) EUTMDR](#).

The evidence submitted is '**manifestly irrelevant**' if, by its nature, it cannot serve to establish the validity and existence of the earlier right invoked (for example, if it proves the existence of an earlier right that was not invoked in the notice of opposition). The evidence submitted is '**manifestly insufficient**' if it does not meet the formal requirements of substantiation.

Upon expiry of the substantiation time limit, the Office carries out a preliminary examination of substantiation. If the opponent submitted evidence for at least one of the earlier rights invoked in the opposition that cannot be qualified as 'manifestly irrelevant' or 'manifestly insufficient', the Office **continues the adversarial part** of the proceedings by forwarding the opponent's submission to the applicant with an invitation to submit observations.

If, upon further examination of the file, the evidence submitted within the substantiation time limit is **still deemed insufficient** to meet the requirements laid down in [Article 7\(2\) EUTMDR](#), the opposition will be rejected in relation to that earlier right pursuant to [Article 8\(7\) EUTMDR](#).

Furthermore, since the initial substantiation check is limited to finding one substantiated earlier right on the basis of which the procedure can continue, if the opposition cannot be fully upheld on the basis of this substantiated earlier right, a further examination of the file in relation to the remaining earlier rights is required. If this examination reveals that the evidence relating to these earlier rights is non-existent, manifestly irrelevant, manifestly insufficient or otherwise insufficient to meet the requirements laid down in [Article 7\(2\)](#), the opposition will also be rejected in relation to these rights pursuant to [Article 8\(7\) EUTMDR](#).

#### 4.2.6 Facts and evidence submitted after the substantiation time limit

[Article 95\(2\) EUTMR](#)

[Article 8\(5\) EUTMDR](#)

All facts and evidence on which the opponent bases its opposition have to be submitted within the substantiation time limit established in [Article 7\(1\) EUTMDR](#). Any fact or evidence submitted after the substantiation time limit is, therefore, late.

Nevertheless, if the opponent submits facts or evidence to substantiate the opposition after the substantiation time limit, the Office may take into account such facts or evidence in exercise of its discretionary power pursuant to [Article 95\(2\) EUTMR](#), subject to the conditions of [Article 8\(5\) EUTMDR](#).

In that context, it must be assessed **first**, whether the Office can exercise any discretionary power and, **second**, if so, how to exercise it, that is, whether to admit or reject such late facts or evidence.

#### 4.2.6.1 Whether discretionary power can be exercised

According to [Article 8\(5\) EUTMDR](#), first sentence, the Office may exercise its discretionary power if the late facts or evidence supplement relevant facts or evidence submitted by the opponent in due time ('initial facts or evidence').

It is clear therefore, that no discretionary power applies if the late facts or evidence relate to an earlier right or ground of opposition invoked in relation to which **no initial evidence** was filed at all within the substantiation time limit. The same applies regarding facts.

However, where **some initial fact or evidence** was submitted, the Office will exercise its discretionary power whether to admit late facts or evidence only if the following conditions are met:

- initial evidence submitted within the substantiation time limit is relevant and not manifestly insufficient; and
- the late fact or evidence relates to the same legal requirement that the initial fact or evidence purported to prove.

Registration certificates that do not contain all the information necessary to establish the existence, scope or validity of the earlier mark concerned would, in principle, be found to be manifestly insufficient evidence, since the content required is precisely and exhaustively established by the regulations.

The Office will find that the late fact or evidence relates to the same legal requirement as the initial fact or evidence only when both sets refer to the same earlier mark, to the same ground and, within the same ground, to the same requirement.

No discretionary power applies where the Office has informed the parties that the opposition will be rejected as unfounded under [Article 8\(1\) EUTMDR](#). In those cases, the proceedings will be resumed only if the opponent requests continuation of proceedings in accordance with [Article 105 EUTMR](#) or *restitutio in integrum* in accordance with [Article 104 EUTMR](#).

For further information on continuation of proceedings, see the Guidelines, [Part A, General Rules, Section 1, Means of Communication, Time Limits](#); and for further information on *restitutio in integrum*, see the Guidelines, [Part A, General Rules, Section 8, Restitutio in Integrum](#).

#### 4.2.6.2 Whether late facts or evidence should be admitted or rejected

For the purposes of exercising its discretionary power, the Office must take into account, in particular, the **stage of proceedings** and whether the facts or evidence are, prima facie, **likely to be relevant** for the outcome of the case and whether there are **valid reasons** for the late submission of the facts or evidence.

- The **stage of the proceedings** indicates how advanced the proceedings are at the time of submitting the late evidence.

- The late evidence is *prima facie* relevant, if it appears to have an impact on the assessment and outcome of the case.
- **Valid reasons** are typically where the supplementing evidence was not yet available before the expiry of the substantiation time limit. There may be other valid reasons.

These factors are interdependent. The later the stage of proceedings, the stronger must be the reason for late submission or the relevance of the evidence. Therefore, additional facts or evidence can be accepted if, *prima facie*, they are likely to be relevant for the outcome of the case and are submitted at an early stage of the proceedings with a justification for why they are being submitted at this stage of the proceedings.

There may be **other relevant factors**. The intention to prolong the proceedings by submitting evidence in parts (delaying tactics), if the circumstances of the case permit this conclusion, argues against the admission of late evidence. Also, the fact that the requirements to be proven are circumscribed in detail in the law or that the Office has explicitly drawn the opponent's attention to those requirements argues against admitting late evidence.

The natural difficulties involved in obtaining the evidence are not, as such, a valid reason for its belated submission.

#### 4.2.6.3 Treatment of late evidence in proceedings

Facts or evidence received after the set time limit will be forwarded to the other party for information purposes without any indication of whether it has been accepted or refused, and will be examined at a later stage, when taking the decision. The proceedings will be reopened and a second round of observations will be granted if necessary — namely, if the Office is considering accepting late facts or evidence and the applicant has not yet had the opportunity to comment on them.

Application of the discretionary power must be reasoned in the decision concluding the opposition. However, where the initial evidence is in itself sufficient to prove the earlier rights and grounds of opposition invoked, there is no need to consider late additional evidence.

### 4.3 Translation/changes of language during the opposition proceedings

Pursuant to general rules set in [Article 146\(9\) EUTMR](#) and [Article 24 EUTMIR](#), most submissions of the parties in opposition proceedings have to be in the language of the proceedings in order to be taken into account. However, for different submissions there are different rules to be applied.

#### 4.3.1 Translations of facts, evidence and arguments submitted by the opponent to complete its file

[Articles 7\(4\) and \(5\) and 8\(1\) EUTMDR](#)

[Article 25\(1\) EUTMIR](#)

On the basis of [Article 24 EUTMIR](#), a distinction should be made between 1) evidence of filing, registration or renewal certificates or equivalent documents, and any provisions of the applicable national law; 2) other evidence submitted to substantiate the opposition; and 3) facts and arguments submitted by the opponent to complete its file.

##### 4.3.1.1 Translation of evidence of filing, registration or renewal certificates or equivalent documents, and provisions of the applicable national law

Pursuant to [Article 7\(4\) EUTMDR](#), any filing, registration or renewal certificates or equivalent documents, as well as any provisions of the applicable national law governing the acquisition of rights and their scope of protection, submitted by the opponent to substantiate the opposition must be either in the language of the proceedings, or be accompanied by a translation into that language. Such translations must be submitted by the opponent on its own motion and within the time limit for substantiation of the opposition. Only what is submitted and translated within this time limit is taken into account.

The requirement for the evidence of substantiation to be translated also relates to online evidence referred to by the opponent, where the language of the online evidence is not the same as the language of the proceedings. This follows from [Article 7\(4\) EUTMDR](#), which states that “evidence accessible online” ... shall [also either] be in the language of the proceedings or shall be accompanied by a translation into that language’.

[Article 25\(1\) EUTMIR](#) requires the translation to reproduce the structure and contents of the original document. For translations of online evidence of substantiation, submission of the translation without the original will be accepted, as long as the document to which it refers is identified correctly.

The Office does not consider that information already given in the language of the proceedings in the notice of opposition, or in documents attached thereto or submitted later (e.g. explanation of grounds, lists of earlier marks, etc.), amounts to a valid translation of a registration document, such as a registration certificate, even where such indications have been accepted for admissibility purposes. The translation has to be on a stand-alone basis and cannot be assembled from fragments taken from other documents.

[Article 25\(1\) EUTMIR](#) provides that the opponent may indicate that only parts of the document are relevant, and therefore the translation may be limited to those parts only.

However, only irrelevant administrative indications (e.g. previous transfers of ownership that do not affect the opposition, administrative entries on fees, etc.) with no bearing on the case may be omitted from the translation. The provisions of [Article 25\(1\) EUTMIR](#) do not imply that the opponent has discretion to decide not to translate the elements required by the Regulation, specifically those listed in [Article 7\(2\) EUTMDR](#) as required for substantiating the earlier rights. Where the Regulation establishes that an element must be proven, as is the case for existence, validity, scope of protection of earlier rights and entitlement to file the opposition, and these particular parts of the evidence are not translated, the opposition may be rejected as non-substantiated.

The Office accepts that no translation of the information headers in the extracts/certificates (such as, 'filing date' 'colour claim', etc.) is needed, provided that they are identified using standard INID codes or national codes.

The list of INID codes and their explanations are attached as Appendix 1 to Standard ST 60 ('Recommendation concerning bibliographic data relating to marks'), available on WIPO's website. The opponent is not required to submit an explanation of the codes.

Where the opposition is based on only some of the goods and services covered by the earlier right, it is sufficient to submit only a translation of the goods and services on which the opposition is based.

When the entire original document is in the language of the proceedings except for the list of goods and services, there will be no need to submit a complete translation following the structure of the original document. In this case, it is acceptable if only the goods and services on which the opposition is based have been translated separately in the notice of opposition or in documents attached thereto or submitted later within the time limit to substantiate the opposition. The same applies to extracts/certificates that make use of INID or national codes, where the only information that still needs to be translated into the language of the proceedings is the list of goods and services. Where the opponent submits a partial translation of the goods and services on which the opposition is based, only the translated goods and services will be deemed properly substantiated. No account will be taken of the goods and services that have not been translated.

When the evidence from an official source contains a representation of the earlier mark in colour accompanied by colour indications, a translation of the colour indications into the language of proceedings is not compulsory.

The Office accepts simple translations, drawn up by anybody. The Office normally does not make use of its faculty to require the translation to be certified by a sworn or official translator unless serious doubts arise regarding the accuracy or content of the translation. Where the representative adds a declaration that the translation is true to the original, the Office will, in principle, not question this. The Office even accepts handwritten text on the copies of the original certificates giving the meaning of the various entries in the language of the proceedings, provided of course that they are complete and legible.

Extracts from commercial databases cannot be considered valid translations of an official document, unless they reproduce the structure and contents of the original document.

If the translation does not reproduce the structure and content of the online database evidence relied upon pursuant to [Article 7\(3\) EUTMDR](#), the opponent will be requested, pursuant to [Article 97\(1\)\(b\)-\(c\) EUTMR](#), to submit a physical copy of the original database extract or an appropriate explanation of the discrepancy (such as that the structure of the database has changed in the meantime). In the absence of such evidence, or if the evidence shows a discrepancy between the translation submitted and the original extract as regards the structure and content, the earlier mark will be deemed to be non-substantiated.

4.3.1.2 Translations of evidence submitted to substantiate the opposition other than filing, registration or renewal certificates or equivalent documents, or provisions of the applicable national law

[Article 7\(4\) EUTMDR](#) also addresses the language regime applicable to evidence submitted by the opposing party to substantiate the opposition other than filing, registration or renewal certificates or equivalent documents, and provisions of applicable national law. Such evidence encompasses, for example, evidence of reputation ([Article 8\(5\) EUTMR](#)) and evidence of use of more than mere local significance ([Article 8\(4\) EUTMR](#)).

If the evidence is submitted in an EU language that is not the language of the proceedings, the Office may, pursuant to [Article 24 EUTMR](#), and either of its own motion or upon reasoned request by the applicant, require the opponent to submit a translation of the evidence into the language of the proceedings within a specified time limit. In other words, the opponent has no obligation to submit the translation on its own motion, unless it is requested to do so by the Office. This language regime mirrors the one applicable to proof of use; hence, rules regarding the translation of proof of use apply equally to the abovementioned evidence for substantiation (see [paragraph 5.6 below](#)).

4.3.1.3 Translations of facts and arguments submitted by the opponent to complete its file

The Office may consider facts and arguments filed by the opponent in support of the opposition only if they are submitted in the language of the proceedings or are accompanied by a translation within the time limit for substantiation. The Office will not request the opponent to send a translation; it has to send one on its own initiative. If no translation or only a partial translation has been submitted within the time limit set, parts of written submissions that have not been translated into the language of proceedings will, pursuant to [Article 7\(5\) EUTMDR](#), not be taken into account.

Articles [7\(4\) and \(5\)](#) and [8\(1\)](#) EUTMDR

If the submissions are not in the language of the proceedings, they must be translated within the time limit specified for submitting the original document, namely within the time limit for substantiation of the opposition.

If this is not done, the legal consequence is that written submissions, or parts thereof, that have not been translated in this time limit are not taken into account. However, if documents proving the existence and validity of the earlier right have not been translated, the opposition must be refused as unfounded straight away.

#### 4.3.2 Translation of further observations and other requests

[Article 146\(9\) EUTMR](#)

[Article 8\(2\), \(4\) and \(6\) EUTMDR](#)

According to [Article 146\(9\) EUTMR](#), the applicant's first reply or the opponent's reply to the applicant's observations may be in any language of the Office.

It is to be noted that if the applicant's first reply or the opponent's counter-reply is not in the language of proceedings but in one of the languages of the Office, the submission will not be taken into account unless the applicant or the opponent submits a translation of these documents in the language of the proceedings within the time limit of 1 month from the date of receipt of the original by the Office. The Office will not request the parties to send a translation; the parties have to send one on their own initiative.

##### Example 1

The language of opposition is English and the applicant has until 26/06/2017 to submit observations in reply to the notice of opposition. If, on 20/06/2017, it submits its observations in reply to the opposition in German, it must file its translation by 20/07/2017. If it does file the translation on or before 20/07/2017, both the original submission and the translation must be taken into account, notwithstanding that the original time limit for filing observations expired on 26/06/2017.

##### Example 2

The language of opposition is English and the applicant has until 26/06/2017 to submit observations in reply to the notice of opposition. If, on 18/05/2017, it submits its observations in reply to the opposition in German, it must file its translation by 18/06/2017. However, as its time limit only expires on 26/06/2017, if it has not filed a translation by 18/06/2017, it can still validly file documents until 26/06/2017. If it then files the translations before the end of the time limit, the Office considers those translations as valid observations filed in the language of the proceedings within the set time limit.



[Article 25\(2\) EUTMIR](#)

If no translation has been submitted or the translation is received after the expiry of the relevant period, the observations are deemed not to have been received by the Office and they will not be taken into account.

The above considerations apply to other requests made during opposition proceedings (e.g. requests for extension, requests for suspension, requests for proof of use, requests for *restitutio in integrum* or continuation of proceedings, withdrawal of the opposition).

#### 4.3.3 Translation of supporting documents other than observations

[Article 24](#) and [Article 25\(2\) EUTMIR](#)

All evidence, with the exception of the evidence that the opponent must submit within the time limit given to substantiate its opposition, can be submitted in any official language of the European Union, as [Article 24 EUTMIR](#) applies. This evidence concerns all documents, other than observations, submitted by the parties after the time limit for the opponent to complete its file.

Examples of this type of evidence are catalogues, magazine articles, decisions of national courts or signed agreements that are submitted by the applicant together with its observations in reply to the opposition.

For this evidence, a translation is needed only if the Office, on its own motion or upon reasoned request by the other party, requests it. Therefore, the parties are not automatically obliged to file a translation.

In principle, the Office does not *ex officio* require a translation. However, it is vital that the party to whom the documents are addressed should be able to understand the meaning of their substantive content. If this is doubtful or is contested by the party addressed, the Office requires a translation within a specified time limit.

[Article 25\(2\) EUTMIR](#) will apply only if the Office requires a translation, with the effect that translations that are filed late must be disregarded; likewise, the original for which a translation is filed late or not at all must also be disregarded.

Together with the invitation to file a translation, the Office will draw the attention of the party concerned to the fact that it is up to that party to evaluate whether a complete translation of all the evidence submitted may be necessary. However, the documents in question will only be taken into account insofar as a translation is submitted or insofar as the documents are self-explanatory, regardless of their verbal components.

#### Example

In the case of a national court decision it may be sufficient to translate only those parts that are relevant for the opposition proceedings.



#### 4.3.4 Change of language during opposition proceedings

[Article 146\(8\) EUTMR](#)

[Article 3 EUTMDR](#)

According to [Article 146\(5\) EUTMR](#) the opposition should be filed in one of the languages of the Office. However, [Article 146\(8\) EUTMR](#) provides that the parties to opposition proceedings may agree to change the procedural language and choose any official language of the European Union for that purpose.

If the parties agree to change the procedural language, they are required, pursuant to Article 3 EUTMDR, to inform the Office accordingly prior to the commencement of the adversarial part of the opposition proceedings. A request to change the language after the commencement of the adversarial part will not be accepted by the Office.

According to [Article 3 EUTMDR](#), when the opponent and the applicant agree to change the language of the proceedings before the start of the adversarial part of the proceedings, the applicant may request that the opponent files a translation of the notice of opposition in that language. In other words, the opponent only has to submit a translation of the notice of opposition if the applicant requests it. The request for translation must be received before the start of the adversarial part of the proceedings. If the translation request is not filed or is filed late, the language of the proceedings will be changed to the language requested.

If a request to submit a translation of the notice of opposition has been filed and it was filed on time, the Office will set the opponent a time limit during which the translation must be submitted, which will be 1 month from expiry of the cooling-off period. Where the translation is not filed or is filed late, the language of the proceedings will remain unchanged.

### 4.4 Requests and other documents related issues

#### 4.4.1 Restrictions, withdrawals and requests for proof of use to be filed by way of a separate document

Articles [8\(8\)](#) and [10\(1\)](#) EUTMDR

Where the applicant wishes to withdraw or restrict a contested application, it must do so by way of a separate document, that is to say in a separate submission or in a separate annex of a submission. Requests merged into observations will not be looked for and will not be accepted, even if included under a separate section, paragraph or header, and even if they appear on the first or last page of the observations.

The same applies to requests for proof of use of an earlier mark pursuant to [Article 47\(2\) or \(3\) EUTMR](#) (for more information on requests for proof of use, see the Guidelines, [Part C, Opposition, Section 1, Opposition Proceedings](#)).

The Office has made available, to that effect, specific ‘e-action’ options in the User Area of the Office website. When a withdrawal or restriction of a contested application or a request for proof of use is submitted by selecting the relevant e-action option, the automatically generated submission will be considered equivalent to a request made by way of a separate document, without any further statement being necessary.

A request, even if spotted, will be refused if it is not submitted ‘separately’ as defined above. The refusal will confirm the reason for the rejection and will be an interim decision appealable together with the decision on the substance.

#### 4.4.2 Documents not readable

[Article 63\(3\) EUTMDR](#)

Where a communication received by electronic means is incomplete or illegible, or where the Office has reasonable doubts as to the accuracy of the transmission, the Office will inform the sender accordingly and invite it, within a time limit to be specified by the Office, to retransmit the original or to submit the signed original by post or courier.

When this request is complied with within the time limit specified, the date of receipt of the retransmission is deemed to be the date of receipt of the original communication.

For more details, see the Guidelines, [Part A, General Rules, Section 1, Means of Communication, Time Limits](#).

#### 4.4.3 No return of original documents

Original documents become part of the file and therefore cannot be returned to the person who submitted them.

However, the party always has the possibility of obtaining a certified or uncertified copy of the original documents, subject to payment of a fee. For further details, see information displayed on the Office’s web page under ‘Inspection of files and copies’.

#### 4.4.4 Confidential information

[Article 114\(4\) EUTMR](#)

Sometimes one of the parties requests the Office to keep certain documents confidential, even vis-à-vis the other party in the proceedings. Although the Office can keep documents confidential vis-à-vis third parties (inspection of files), it can under no circumstances keep them confidential vis-à-vis the other party in *inter partes* proceedings.

Each party to the proceedings must always have the right to defend itself. That means that it should have full access to all material submitted by the other party.

It follows that all material submitted by a party should be disclosed to the other party of the proceedings. The Office has an obligation to communicate all material received to the other party. Therefore, if one of the parties requests that certain documents be kept confidential without mentioning whether this should be vis-à-vis third parties, the Office will take it for granted that this is the case and will forward them to the other party and mark them as confidential in the electronic file.

If, in the course of opposition proceedings, the Office receives documents with a request that they be kept confidential *inter partes*, the sender should be informed that the documents cannot be kept confidential vis-à-vis the other party to the proceedings.

To this end, a letter has to be sent, clearly explaining that the sender may choose between disclosing or withdrawing the documents. It is up to the party to decide which of these possibilities is appropriate for its case and to inform the Office accordingly.

If it confirms confidentiality, the documents will not be sent to the other party and will not be taken into account. They will be marked as confidential in the electronic file.

If it wants the documents to be taken into account but not be made available for third parties, the documents can be forwarded to the other party, but must be marked confidential in the electronic file.

If it does not reply within the time limit specified, the documents will not be sent to the other party and will not be taken into account. They will be marked as confidential in the electronic file.

For more information on confidentiality claims, reference is made to the Guidelines, [Part A, General Rules, Section 1, Means of communication, time limits](#) and [Part E, Register Operations, Section 5, Inspection of Files](#).

#### 4.4.5 References made to documents or items of evidence in other proceedings

The parties may refer, in their observations, to documents or evidence submitted in other proceedings, for instance to evidence of use that has already been submitted in a different opposition.

For more information on how these documents or items should be identified, and how the Office will process these requests, see the Guidelines, [Part A, Section 1, Means of communication, time limits, paragraph 3.1.7](#).

## 4.5 Further exchanges

[Article 8\(2\), \(4\), \(6\) and \(9\) EUTMDR](#)

Article [24](#) and Article [25\(2\)](#) EUTMIR

The Office invites the applicant to file observations within the time limit set by it in accordance with [Article 8\(2\) EUTMDR](#).

The applicant can request proof of use of the earlier right with or without submitting observations at the same time on the grounds on which the opposition is based. In that case, the observations may be submitted together with the observations in reply to the proof of use.

In appropriate cases, the Office may invite the parties to limit their observations to particular issues. In that case, the party is allowed to raise the other issues at a later stage of the proceedings.

Once the applicant has submitted its observations in reply, the opponent is granted a final time limit to submit its counter-reply if the Office considers it necessary. After this, the adversarial part of the proceedings is usually closed, and the opposition is ready for decision.

The Office may, however, grant the possibility of another exchange of observations. This can occur when the case deals with complex issues or when the opponent raises a new point and it is admitted to the proceedings. In this case, the applicant must be given a possibility of replying. The Office may exercise its discretion in deciding whether another round of observations should be granted to the opponent (e.g. if the applicant raises new issues such as the coexistence of the marks, the invalidity of the earlier right or an agreement between parties).

## 4.6 Observations by third parties

[Article 45 EUTMR](#)

Communication No [2/09](#) of the Executive Director of the Office of 9 November 2009

Third parties can make observations explaining why the EUTM application should not be registered under [Article 5 EUTMR](#) or on the basis of one of the absolute grounds of [Article 7 EUTMR](#). For further details, see the Guidelines, [Part B, Examination, Section 4, Absolute Grounds for Refusal](#), and the Guidelines, [Part B, Examination, Section 1, Proceedings](#).

Anybody can submit third-party observations; even the opponent is entitled to do so. However, it should do so in a manner that leaves no doubt that they are third-party observations. According to the abovementioned Communication of the Executive Director of the Office, the observations must be submitted separately. However, in

practice (30/11/2004, [R 735/2000-2](#), Serie A (fig.) / LEGA PALLAVOLO SERIE A), the 'separate submission' requirement is deemed to be satisfied when the observations are clearly separable from the grounds and arguments supporting the opposition, even if they are included in the same document. As long as the opponent expressly mentions that it wishes to make observations under [Article 45 EUTMR](#), these will be dealt with, even if they are not submitted separately. However, if in its submission the opponent argues that the EUTM application should have been refused under Articles [5](#) and [7](#) EUTMR, without any reference to the contents of [Article 45 EUTMR](#), this submission will not be regarded as third-party observations under [Article 45 EUTMR](#).

When an opponent makes third-party observations, the Office will consider if the observations raise serious doubts as to the registrability of the EUTM application, or if they will only be sent to the applicant for information purposes.

If the observations raise serious doubts, the Office must suspend the opposition proceedings until a decision on the observations is taken. In cases where the observations do not raise serious doubts (i.e. when the observations have only been sent to the applicant for information purposes) or do not affect the contested goods or services, the opposition proceedings will not be suspended. If the opposition proceedings need to be suspended, the suspension will take effect from the date when the Office issues the objection under Article 7 EUTMR, and proceedings will remain suspended until a final decision has been taken. Where the third-party observations are received within the 3-month opposition period, the Office will first deal with the admissibility of the opposition and, once the decision on admissibility has been notified, the opposition proceedings will be suspended.

For oppositions closed due to third-party observations, the opposition fee will not be refunded, as no provision for such refund is made in the regulations (see [Article 6\(5\) EUTMDR](#)).

## **5 Procedure related to the request for proof of use**

### **5.1 Admissibility of the request for proof of use**

According to [Article 47\(2\) EUTMR](#), use of the earlier mark needs to be shown only if the applicant requests proof of use. The institution of proof of use is, therefore, designed in opposition proceedings as a **defence plea of the applicant**.

The Office may neither inform the applicant that it could request proof of use nor invite it to do so. In view of the Office's impartial status in opposition proceedings, it is left to the parties to provide the factual basis and to argue and defend their respective positions (see second sentence of [Article 95\(1\) EUTMR](#)). It follows that the applicant may also limit its request for proof of use to one or some of the earlier marks relied on (even if all would be subject to the genuine use requirement), or to only some of the goods or services on which the opposition is based. In such a case, the Office will

require the opponent to prove genuine use of its mark within the limited scope requested by the applicant.

[Article 47\(2\) EUTMR](#) is not applicable when the opponent, on its own motion, submits material relating to use of the earlier mark invoked (for example, for the purposes of proving enhanced distinctiveness under [Article 8\(1\) EUTMR](#), well-known character under [Article 8\(2\)\(c\) EUTMR](#), or reputation under [Article 8\(5\) EUTMR](#)). As long as the EUTM applicant does not request proof of use, the issue of genuine use will not be addressed by the Office *ex officio*. In such cases, in principle, it is even irrelevant that the evidence produced by the opponent might demonstrate only a particular type or manner of use, or use that is limited to only part of the goods or services for which the earlier mark is registered.

#### 5.1.1 Time of request

The request for proof of use must be made within the first time limit for the applicant to reply to the opposition (Article [10\(1\)](#) and [8\(2\)](#) EUTMDR).

Nevertheless, the Office also accepts requests for proof of use submitted during the cooling-off period or during the 2-month period given to the opponent to substantiate the opposition. If the request for proof of use is admissible, the Office will invite the opponent to submit proof of use, ensuring that it always has at least 2 months to do so.

#### 5.1.2 Earlier mark registered for not less than 5 years (mark outside the 'grace period')

The owner must put the mark to genuine use within a period of 5 years following its registration ([Article 18\(1\) EUTMR](#)). However, the owner has a 'grace period' of 5 years after registration, during which it cannot be required to demonstrate use of the mark in order to rely upon it. During the 'grace period', the mere formal registration gives the mark full protection. Once this period lapses, the proprietor may be required to prove genuine use of the earlier mark.

For oppositions filed **against EUTM applications**, the opponent may be required to prove genuine use if, on the date of filing or on the date of priority <sup>(38)</sup> of the EUTM application, the earlier mark has been registered for not less than 5 years ([Article 47\(2\) EUTMR](#)).

For oppositions filed against **international registrations designating the EU**, the opponent may be required to prove genuine use if, on the date of registration of the IR (INID code 151) or on the date of its priority (INID code 300), or, as the case may be, the date of subsequent designation of the European Union (INID code 891) <sup>(39)</sup>, the earlier mark has been registered for not less than 5 years.

If the earlier mark is still within the grace period for non-use, any request for proof of use will be refused. This will be the case even if the applicant alleges that the earlier

---

<sup>38</sup> For EUTM applications filed before 23/03/2016, the relevant date is the date of publication.

<sup>39</sup> For international registrations designating the EU filed before 23/03/2016, the relevant date is the date of first publication of the contested IR or its subsequent designation in the EUTM Bulletin.

mark had been refiled with the intention of circumventing the limitation of the grace period, since such a claim cannot be examined in opposition proceedings (19/10/2017, [T-736/15](#), SKYLITE (fig.) / SKY et al., EU:T:2017:729, § 20-28; 16/05/2019, [T-354/18](#), SKYFi / SKY et al., EU:T:2019:33, § 41-43, 46-48).

#### 5.1.2.1 Earlier EUTMs

The decisive date for establishing whether a trade mark has been registered for not less than 5 years at the relevant date is, according to Article [18\(1\)](#) and Article [47\(2\)](#) EUTMR, the **registration date** of the earlier EUTM, that is to say, the date of entry of the EUTM in the Register as published, pursuant to [Article 111\(2\)\(o\) EUTMR](#), under INID code 151. If 5 years or more have elapsed between the registration date of the earlier EUTM and the relevant date, the applicant (or in the case of a contested IR, the holder) is entitled to request proof of use.

#### 5.1.2.2 Earlier international registrations designating the European Union

For earlier international registrations designating the European Union, the date of **second republication of the EU designation** pursuant to [Article 190\(2\) EUTMR](#) marks the beginning of the calculation of the 5-year grace period for non-use ([Article 203 EUTMR](#)). This date corresponds to the date of publication of the EU designation in part M.3.1 of the EUTM Bulletin.

#### 5.1.2.3 Earlier national marks

For national marks, the ‘date of completion of the registration procedure’, as provided for in [Article 16\(1\) of Directive \(EU\) 2015/2436](#), serves for calculating the starting point of the 5-year grace period for non-use. That date is determined by each Member State according to its own procedural rules (14/06/2007, [C-246/05](#), Le Chef de Cuisine, EU:C:2007:340, § 26-28).

Some Member States in particular provide for opposition proceedings **following registration** <sup>(40)</sup>. For these national marks, the ‘registration date’ cannot be the relevant date for calculating the 5-year grace period. Instead, the 5-year period must be calculated from the date when the mark can no longer be opposed or, in the event that an opposition has been lodged, from the date when a decision terminating the opposition proceedings becomes final or the opposition is withdrawn ([Article 16\(2\) of Directive \(EU\) 2015/2436](#), as implemented in the respective national legislation).

Pursuant to [Article 16\(4\) of Directive \(EU\) 2015/2436](#), Member States are required to enter the date of commencement of the 5-year period in the register. Until this information becomes readily available in the respective official trade mark databases, the relevant date in the respective jurisdictions can be consulted in the table in the

---

<sup>40</sup> Germany, Austria, Finland, Sweden, Latvia and in the case of marks registered via the ‘accelerated procedure’, in Benelux.



Annex to this section. The Office will rely on the information in that table to determine whether a request for proof of use against a particular national mark is admissible.

#### 5.1.2.4 Earlier international registrations designating a Member State

[Article 16\(3\) of Directive \(EU\) 2015/2436](#) provides that, for international registrations having effect in a Member State, the relevant 5-year period must be calculated from the date when the mark can no longer be rejected or opposed. Where an opposition has been lodged or when an objection on absolute or relative grounds has been notified, the period must be calculated from the date when a decision terminating the opposition proceedings or a ruling on absolute or relative grounds for refusal becomes final or the opposition is withdrawn.

Under Article 5(2)(a) and (b) of the Madrid Protocol, the Designated Offices have a period of 12 or 18 months from the date of notification of the designation to issue provisional refusals. Where the Member State has not been designated in the international application but in a subsequent designation, the 12 or 18 months start from the date the subsequent designation was notified to the designated offices. If no provisional refusal is notified to the International Bureau within the applicable time limit, the international registration is deemed to be protected in the designated country (principle of tacit acceptance, Article 4(1) of the Madrid Protocol).

Member States that use the **12-month deadline** to issue a provisional refusal under the Protocol when acting as a designated party are: Belgium, Czech Republic, Germany, Spain, France, Croatia, Latvia, Luxembourg, Hungary, Netherlands, Austria, Portugal, Romania and Slovenia.

Member States that have opted for the **18-month deadline** to issue a provisional refusal under the Protocol when acting as a designated party are: Denmark, Estonia, Ireland, Greece, Lithuania, Finland and Sweden.

The applicable deadline (**12 or 18 months**) for Bulgaria, Italy, Cyprus, Poland and Slovakia when acting as a designated party depends on whether (i) such country was designated or subsequently designated before or after 01/09/2008 and (ii) the office of origin is bound by both the Agreement and the Protocol (deadline: 12 months) or only the Protocol (deadline: 18 months).

See overview table below:



Designated country <sup>(41)</sup>	Country of origin	Deadline to issue a refusal
<p><i>Belgium, Czech Republic, Germany, Spain, France, Croatia, Latvia, Luxembourg, Hungary, Netherlands, Austria, Portugal, Romania and Slovenia</i></p> <p>(Contracting EU parties bound by <b>both</b> the Agreement and the Protocol)</p>	<p><i>All contracting parties</i></p> <p>[Status 06/04/2022: 112 members] <sup>(42)</sup></p> <p>(Irrespective of whether they are bound by both the Agreement and the Protocol or the Protocol only)</p>	12 months
<p><i>Denmark, Estonia, Ireland, Greece, Lithuania, Finland, Sweden</i></p> <p>(Contracting EU parties bound by the Protocol <b>only</b>)</p>	<p><i>All contracting parties</i></p> <p>[Status 06/04/2022: 112 members]</p> <p>(Irrespective of whether they are bound by both the Agreement and the Protocol or the Protocol only)</p>	18 months
<p><i>Bulgaria, Italy, Cyprus, Poland, Slovakia; if designated or subsequently designated before 01/09/2008</i> <sup>(43)</sup></p> <p>(Contracting EU parties bound by both the Agreement and the Protocol that have opted for an <b>extended</b> deadline)</p>	<p><i>All contracting parties</i></p> <p>[Status 06/04/2022: 112 members]</p> <p>(Irrespective of whether they are bound by both the Agreement and the Protocol or the Protocol only)</p>	18 months
<p><i>Bulgaria, Italy, Cyprus, Poland, Slovakia; if designated or subsequently designated on or after 01/09/2008</i></p> <p>(Contracting EU parties bound by both the Agreement and the Protocol that have opted for an <b>extended</b> deadline)</p>	<p><i>Contracting parties bound by both the Agreement and the Protocol</i></p> <p>[Status 06/04/2022: 55 members]</p>	12 months
	<p><i>Contracting parties bound by the Protocol only</i></p> <p>[Status 06/04/2022: 57 members]</p>	18 months

To determine whether the earlier international registration designating a Member State is subject to the requirement to prove use, the Office first verifies that the designation in

<sup>41</sup> Malta is not part of the Madrid System.

<sup>42</sup> See the full list of all Member States to the Regulations under the Protocol relating to the [Madrid Agreement Concerning the International Registration of Marks](#) (also as Regulations under the Protocol).

<sup>43</sup> The date of entry into force of Article 9sexies(1)(b) of the Protocol, which rendered inoperative any declaration under Article 5(2)(b) or (c) of the Protocol (extension of the time limit for notifying a provisional refusal) between Contracting Parties bound by both the Agreement and the Protocol.

question is not pending a provisional refusal of protection or has been refused by a final decision. If a provisional refusal is pending, the registration procedure cannot yet be deemed to be completed. If the provisional refusal has been confirmed by a final decision, the relevant designation cannot be taken into account as a basis of opposition, to the extent it has been refused.

Next, the Office checks whether a statement of grant of protection has been issued. If so, the Office will, on its own motion, consider the **date of publication of the statement of grant of protection** in the WIPO Gazette (indicated by INID code 450 under the relevant heading of the Madrid Monitor extract) as the start date for calculating the 5-year grace period (Rule 18*ter*(1) and (2) of the Regulations under the Protocol Relating to the Madrid Agreement).

Where no statement of grant of protection has been issued, the Office will, on its own motion, consider the **date of expiry of the time limit to notify a refusal** as the start date for calculating the 5-year grace period. That date is calculated by adding the relevant 12-month or 18-month period, according to the above rules, to the date of notification of the international registration or its subsequent designation from which the time limit to notify the refusal starts (indicated by INID code 581 under the relevant heading of the Madrid Monitor extract, see Rule 18(1)(a)(iii) of the Regulations under the Protocol Relating to the Madrid Agreement).

Only when it is decisive for determining whether the earlier mark is subject to the requirement to prove use can the opponent claim a date that is **later** than the one taken into account by the Office on its own motion (e.g. when the designated country opted for a period even longer than 18 months for notifying a refusal based on an opposition pursuant to Article 5(2)(c) of the Madrid Protocol, or when all the procedures concerning the protection of the mark before the designated office have been completed subsequent to the issuing of the statement of grant of protection, pursuant to Rule 18*ter*(4) of the Regulations under the Protocol Relating to the Madrid Agreement). This is also true should the applicant or holder wish to claim a date that is **earlier** than these dates (e.g. the date following the expiry of the opposition period, where no opposition has been filed – see [Article 16\(3\) of Directive \(EU\) 2015/2436](#)). Conclusive evidence to support these claims must be submitted to the Office.

#### 5.1.2.5 Summary of calculation of the beginning of the grace period

Earlier mark	Calculation of the beginning of the 5-year grace period
<b>EUTM</b>	Date of registration.
<b>IR designating the EU</b>	Date of the second republication of the EU designation in part M.3.1 of the EUTM Bulletin.

Earlier mark	Calculation of the beginning of the 5-year grace period
<b>National mark</b>	The date of completion of the registration procedure, as defined in national law (see table in Annex).
<b>IR designating Member States</b>	By default, the date of publication of the statement of grant of protection in the WIPO Gazette (INID code 450 of the relevant heading).

### 5.1.3 Request must be unconditional, explicit and unambiguous

The applicant's request is a formal declaration with important procedural consequences.

Pursuant to [Article 10\(1\) EUTMDR](#), the request has to be **unconditional**. Phrases such as 'if the opponent does not limit its goods/services in Classes 'X' or 'Y', we demand proof of use', 'if the Office does not reject the opposition because of lack of likelihood of confusion, we request proof of use' or 'if considered appropriate by the Office, the opponent is invited to file proof of use of its trade mark' contain conditional or auxiliary claims and, therefore, are not valid requests for proof of use (26/05/2010, [R 1333/2008-4](#), RFID SOLUTIONS (fig.) / rfid (fig.)).

Moreover, the request has to be **explicit and unambiguous**. In general, the request for proof of use must be expressed in positive wording. As use or non-use can be an issue in manifold constellations (for example, to invoke or deny a higher degree of distinctiveness of the earlier mark), mere observations or remarks by the applicant in respect of the (lack of) use of the opponent's mark are not sufficiently explicit and do not constitute a valid request for proof of genuine use (16/03/2005, [T-112/03](#), Flexi Air, EU:T:2005:102).

#### Examples

Sufficiently explicit and unambiguous request:

- 'I request the opponent to submit proof of use ...';
- 'I invite the Office to set a time limit for the opponent to prove use ...';
- 'Use of the earlier mark is hereby contested ...';
- 'Use of the earlier mark is disputed in accordance with [Article 47 EUTMR](#).';
- 'The applicant raises the objection of non-use.' (05/08/2010, [R 1347/2009-1](#), CONT@XT / CONTXTA).

Not sufficiently explicit and unambiguous request:

- 'The opponent has used its mark only for ...';
- 'The opponent has not used its mark for ...';
- 'There is no evidence that the opponent has ever used its mark ...';

- '[T]he opponents' earlier registrations cannot be "validly asserted against the [EUTM] application...", since "...no information or evidence of use ... has been provided..." (22/09/2008, [B 1 120 973](#)).

Not only the request, but also the scope of the request, has to be explicit and unambiguous. The Office will accept the request only for goods and services listed literally in the specification of the earlier mark and on which the opposition is based. The following are examples where the scope of the request is not explicit and unambiguous:

- 'I request that the opponent prove genuine use of the earlier mark for the goods applied for in the contested mark' — the applicant cannot request that the opponent prove use of the applicant's own goods (see, for example, 24/09/2008, [R 1947/2007-4](#), HOKAMP / HOLTKAMP, § 20);
- 'I request that the opponent prove genuine use of the earlier mark for goods that are identical or similar to the goods applied for' — the scope of the request cannot be defined by reference to the applicant's goods and cannot be subject to interpretation;
- 'I request that the opponent prove genuine use for *trousers* and *shirts*' — where the goods of the earlier mark are *clothing, footwear and headgear*. The scope of an explicit request cannot be subject to interpretation. Neither the Office nor the opponent is required to determine whether an item is covered by a broader category of the specification of the earlier mark. Furthermore, the opponent cannot be required to prove use of a specific item within a category because he may prove genuine use for that category by other items included therein (see, for example, 24/09/2008; [R 1947/2007-4](#), HOKAMP / HOLTKAMP, § 23; 07/07/2009, [R 1294/2008-4](#), ORDACTIN / Orthangin, § 16; 08/10/2010, [R 1316/2009-4](#), miha bodytec / bodytec, § 18).

The Office will refuse a request for proof of use whose scope is not explicit and unambiguous.

#### 5.1.4 Request made in a separate document

Pursuant to [Article 10\(1\) EUTMDR](#) in conjunction with [Article 8\(2\) EUTMDR](#), the request for proof of use is only admissible if it is submitted as an unconditional request in a separate document within the period specified by the Office ( [28/06/2021, R 2142/2018-G, DIESEL SPORT beat your limits \(fig.\) / Diesel et al., § 54](#)).

The requirement for filing by way of a separate document is fulfilled when the proof of use request is filed as a **separate submission** or in a **separate annex** of a submission. Requests merged into observations will not be looked for and will not be accepted, even if included under a separate section, paragraph or header and even if they appear on the first or last page of the observations.

For submission of requests for proof of use via e-communication, the Office has made available the specific 'e-action' option '**Request proof of use**'. When a request for proof of use is submitted by selecting the relevant e-action option, the automatically generated submission will be considered equivalent to a request made by way of a

separate document, without any further statement being necessary. It is recommended that the e-action option 'Request proof of use' be used when a request for proof of use is filed via the User Area.

The 'separate document' requirement can also be fulfilled by submitting the request for proof of use via the e-action 'Submit observations'. This could be the case when the request is submitted as a separate annex of a submission, but not merged into the applicant's observations. The request has to be annexed to the applicant's observations in a clearly defined manner (e.g. Annex 1 – Restriction of the list of goods and services; Annex 2 – Request for proof of use; etc.)

Furthermore, the requirement to submit a request for proof of use by way of a 'separate document' is not to be equated to submitting it by way of a 'separate electronic file attachment'. Joining submissions for the purposes of communication does not preclude the presentation of the request by way of a 'separate document'. The applicant's observations and the request for proof of use can be submitted in a single electronic file attachment (e.g. in a single PDF file), as long as the request for proof of use forms a separate annex of the submission ([28/06/2021, R 2142/2018-G, DIESEL SPORT beat your limits \(fig.\) / Diesel et al., § 46-48](#)).

#### 5.1.5 Applicant's interest to deal with proof of use first

Under [Article 10\(5\) EUTMDR](#) a request for proof of use may be submitted at the same time as observations. The applicant may limit its first observations to requesting proof of use. It must then reply to the opposition in its second observations, namely when it is given the opportunity to reply to the proof of use submitted. It may also do this if only one earlier right is subject to the use requirement, as the applicant should not be obliged to split its observations.

#### 5.1.6 Consequences of an inadmissible request for proof of use

Where an inadmissible request for proof of use is accompanied by observations on the opposition, the Office advises the parties about the inadmissibility of the request and continues the proceedings without inviting the opponent to submit evidence of use of the earlier marks.

Where an inadmissible request for proof of use is not accompanied by observations on the opposition, the Office advises the parties about the inadmissibility of the request and closes the adversarial part of the proceedings. However, the Office can extend the time limit established in [Article 8\(2\) EUTMDR](#) if the inadmissible request was received before expiry of the time limit set for the applicant but was not dealt with by the Office until after it expired. Given that refusing the request for proof of use after expiry of the time limit will disproportionately harm the applicant's interests, the Office will extend the time limit for the applicant to submit its observations on the opposition by the number of days that were left when the party submitted its request. This practice is based on the rules of fair administration.

If the request is inadmissible only for some of the earlier marks on which the opposition is based (e.g. where some of the earlier marks are subject to the obligation to prove genuine use but others are not), the Office expressly limits the invitation to the opponent to submit proof of use to the earlier marks that are subject to the obligation to prove genuine use.

## 5.2 Express invitation by the Office

If the applicant's request for proof of use is valid, the Office gives the opponent two months to submit proof of use or show that there are proper reasons for non-use. Taking a decision on use in the absence of an explicit invitation by the Office to submit proof of use constitutes a substantive procedural violation, even if the applicant's request is clear, and the opponent understands it and submits the requested evidence of use (28/02/2011, [R 16/2010-4](#), COLORPLUS, § 20; 19/09/2000, [R 733/1999-1](#), AFFINITÉ / AFFINAGE).

In cases where the request for proof of use arrives during the cooling-off period and is communicated to the opponent during that period, the deadline for submitting proof of use will coincide with the deadline for providing initial or additional facts, evidence and arguments. The time limit will be extended automatically if the cooling-off period is extended.

If the request reaches the Office before the end of the period for submitting or amending facts, evidence and arguments, and is dealt with in this period, the deadline for submitting such facts, evidence and arguments will be extended to coincide with the deadline of 2 months for submitting proof of use.

## 5.3 Reaction from the opponent: providing proof of use

### 5.3.1 Time limit for providing proof of use

The Office gives the opponent 2 months to submit proof of use. The opponent may request an extension of the deadline in accordance with [Article 68 EUTMDR](#). The common practice on extensions is applicable to these requests (see [paragraph 7.2.1 below](#)).

[Article 10\(2\) EUTMDR](#) expressly states that the Office will reject the opposition if the opposing party does not provide proof of use before the time limit expires.

Three scenarios are to be differentiated.

- Any evidence that has been submitted by the opponent at any time during the proceedings before the expiry of the time limit for providing proof of use, even before the applicant's request for proof of use, has to be automatically taken into account when assessing proof of use.
- The opponent has not submitted **any or any relevant indication or evidence** within the time limit: the submission of relevant indications or evidence of proof of

use for the first time after the expiry of the time limit results in rejection of the opposition **without the Office having any discretionary powers**. [Article 10\(2\) EUTMDR](#) is an essentially procedural provision and it is apparent from the wording of that provision that when no proof of use of the mark concerned is submitted within the time limit set by the Office, the opposition must automatically be rejected. However, if the opposition is also based on other earlier marks that are not subject to the proof of use requirement, the proceedings will continue based on those earlier marks.

- The opponent has submitted **relevant indications or evidence** within the time limit and presents **additional indications or evidence** after the time limit has expired. The Office may take into account the evidence submitted out of time by **exercising the discretion** conferred on it by [Article 95\(2\) EUTMR](#). In that context, it must be assessed **first**, whether the Office may exercise discretion, and, if so, **second**, how to exercise its discretion, that is, whether to admit or reject such late facts or evidence.

According to [Article 10\(7\) EUTMDR](#), the Office must exercise its discretion if the late indications or evidence merely supplement, strengthen and clarify the prior relevant evidence submitted within the time limit with the purpose of proving the same legal requirement laid down in [Article 10\(3\) EUTMDR](#), namely, place, time, extent and nature of use of the opposing trade mark for the goods or services in respect of which it is registered and on which opposition is based. It follows that the Office may not exercise any discretion if the late evidence intends to prove a legal requirement for which no initial evidence at all had been submitted. For example, if no indications or evidence related to the place of use were submitted at all within the relevant time limit, any evidence submitted in this respect after the time limit must be discarded.

When exercising its discretion, the Office must take into account, in particular, the **stage of proceedings** and whether the facts or evidence are, prima facie, **likely to be relevant** for the outcome of the case and whether there are **valid reasons** for the late submission of the facts or evidence.

These factors are interdependent. The later the stage of proceedings, the stronger must be the reason for late submission or the relevance of the evidence. Therefore, additional indications or evidence can be accepted if, prima facie, they are likely to be relevant for the outcome of the case and are submitted at an early stage of the proceedings with justification for why they are submitted at this stage of the proceedings.

There may be **other relevant factors**. The intention to prolong the proceedings by submitting evidence in parts (delaying tactics), if the circumstances of the case allow that conclusion, argues against the admission of late evidence.

The natural difficulties in obtaining the evidence are not, as such, a valid reason for its belated submission.

The Office will duly provide reasons for why it rejects or takes into account 'additional evidence' in the decision.



## 5.3.2 Means of evidence

### 5.3.2.1 Principles

The evidence of use must be provided in a structured manner.

[Article 95\(1\) EUTMR](#) provides that ‘... in proceedings relating to relative grounds for refusal of registration, the Office shall be restricted in this examination to the facts, evidence and arguments provided by the parties ...’ The filing of evidence must be sufficiently clear and precise to enable the other party to exercise its right of defence and the Office to perform its examination, without reference to extraneous or supportive information.

Essentially, the Office is prevented from making the case for one or other party and cannot take the place of the opponent, or its counsel, by itself trying to locate and identify among the documents on file the information that it might regard as supporting proof of use. This means that the Office should not seek to improve the presentation of any party’s evidence.

Responsibility for putting evidence in order rests with the party. [Article 10\(4\) EUTMDR](#) provides that the evidence of use must be submitted in accordance with [Article 55 EUTMDR](#), which defines the basic structure and format of written evidence. This provision means that the submission must clearly identify the evidence and arguments raised by the parties and thus assure expeditious proceedings.

For further information on the format and structure requirements for annexes to communications, and recommendations on the structure of written evidence, refer to the Guidelines, [Part A, General Rules, Section 1, Means of Communication, Time Limits, paragraph 3.1.3](#).

The recommendations together with the requirements for written evidence set in [Article 55\(2\) EUTMDR](#) are sent to the opponent together with the Office’s communication of the applicant’s request for proof of use.

According to [Article 10\(4\) EUTMDR](#), the evidence is to be submitted in accordance with [Article 55\(2\)](#) and [Articles 63](#) and [64 EUTMDR](#) and, in principle, is confined to the submission of supporting documents and items such as packages, labels, price lists, catalogues, invoices, photographs, newspaper advertisements, and statements in writing as referred to in [Article 97\(1\)\(f\) EUTMR](#). [Article 10\(4\) EUTMDR](#) also allows market surveys and quotations of the mark in lists and publications of associations of the relevant profession as suitable means of evidence (14/03/2011, [B 1 582 579](#); 18/06/2010, B 1 316 134).

Price lists and catalogues are examples of ‘material stemming directly from the party itself’. A company’s annual report and accounts would also come under that heading.

[Article 10\(4\) EUTMDR](#) is to be read in conjunction with [Article 64 EUTMDR](#). This means that annexes to communications may be submitted on data carriers in accordance with technical specifications determined by the Executive Director. Nevertheless, material that cannot be scanned or photocopied (such as physical items)



cannot be taken into account unless submitted in two copies so that one can be forwarded to the other party.

The requirement of proof of use always raises the question of the **probative value** of the submitted material. The evidence must at least have a certain degree of reliability. As a general rule, the Office considers material produced by third parties as being of a higher probative value than material produced by the owner itself or by its representative. Reference by the opponent to internal printouts or hypothetical surveys or orders is particularly problematic. However, where material must regularly be produced for use by the public and/or authorities according to statutory rules, for instance, company law and/or stock exchange regulations, and where it may be assumed that such material is subject to certain official verification, its probative value is certainly higher than ordinary 'personal' material produced by the opponent (see also [paragraph 5.3.2.3, 'Declarations', below](#)).

#### 5.3.2.2 References

The opponent may avail itself of findings of national offices and courts in parallel proceedings. Although the Office is not bound by findings of the national offices and courts, such decisions must be taken into account and may influence the Office's decision. It is important for the Office to have the possibility of considering the kind of evidence that led to the relevant decision at national level. The Office takes into account the different procedural and substantive requirements that may exist before the respective national body (25/08/2003, [R 1132/2000-4](#), VANETTA / VIENNETTA (fig.), § 16; 18/10/2000, [R 550/1999-3](#), (DUKE) (fig.) / DUKE, § 23).

The opponent may wish to refer to material submitted as proof of use in previous proceedings before the Office. The Office accepts such references on condition that the opponent clearly identifies the material referred to and the proceedings in which it was submitted. If the reference does not sufficiently identify the relevant material, the Office requires the opponent to clearly specify the material referred to or to file it (30/11/2010, [B 1 080 300](#)). For further details on the conditions for identifying relevant material, see [paragraph 4.4.5](#).

The onus of providing proof of use is on the opponent and not on the Office or the applicant. Therefore, a mere indication of the website where the Office can find further information is insufficient, as this does not provide the Office with sufficient indications about place, nature, time and extent of use (31/10/2001, [B 260 192](#)). For further information regarding evidence originating from the internet, see the Guidelines, [Part C, Opposition, Section 5, Trade marks with reputation \(Article 8\(5\) EUTMR\), paragraph 3.1.4.4](#).

#### 5.3.2.3 Declarations

Whereas the means of evidence listed, such as packages, labels, price lists, catalogues, invoices, photographs and newspaper advertisements, do not present any

particular problems, it is necessary to consider in some detail declarations as referred to in [Article 97\(1\)\(f\) EUTMR](#).

The opposing party is not obliged to submit an affidavit concerning the sales made under the earlier trade mark. It is up to the opposing party to select the form of evidence that it considers suitable for the purpose of establishing that the earlier trade mark was put to genuine use during the relevant period (08/07/2004, [T-203/02](#), Vitafruit, EU:T:2004:225, § 37).

The role of the affidavit is to give facts or an explanation of the supporting documents, not to give a legal opinion (06/11/2014, [T-463/12](#), MB, EU:T:2014:935, § 56).

#### Distinction between admissibility and relevance (probative value)

The importance of declarations has been much debated. In this regard, there must be a clear differentiation between the admissibility and the probative value of such evidence.

As far as **admissibility** is concerned, [Article 10\(4\) EUTMDR](#) expressly mentions written statements referred to in [Article 97\(1\)\(f\) EUTMR](#) as admissible means of proof of use. [Article 97\(1\) EUTMR](#) cites means of giving evidence, amongst which are sworn or affirmed written statements or other statements that have a similar effect according to the law of the State in which they have been drawn up. Therefore, it has to be evaluated whether the statement submitted constitutes a statement within the sense of [Article 97\(1\)\(f\) EUTMR](#). Only in cases where the statements have not been sworn or affirmed is it necessary to consider the rules of law of the national jurisdiction as to the effects of a written statement (07/06/2005, [T-303/03](#), Salvita, EU:T:2005:200, § 40; confirmed 09/12/2014, [T-278/12](#), PROFLEX, EU:T:2014:1045, § 49). Where there are doubts as to whether a statement has been sworn or affirmed, it is up to the opponent to submit evidence in this regard. Failing this, the statement will not be considered a statement within the sense of [Article 97\(1\)\(f\) EUTMR](#).

[Article 97\(1\)\(f\) EUTMR](#) does not specify by whom these statements should be signed, so there is no reason to consider that statements signed by the parties to the proceedings themselves are not covered by this provision (16/12/2008, [T-86/07](#), Deitech, EU:T:2008:577, § 46).

The EUTMR, the EUTMDR and the EUTMIR do not support the conclusion that the evidential value of items of evidence of use of the mark, including affirmations, must be assessed in the light of the national law of a Member State (28/03/2012, [T-214/08](#), Outburst, EU:T:2012:161, § 33; 09/12/2014, [T-278/12](#) PROFLEX, EU:T:2014:1045, § 53). The probative value of a statement depends first and foremost on the credibility of the account it contains. It is then necessary to take account, in particular, of the person from whom the document originates, the circumstances in which it came into being, the person to whom it was addressed and whether, on the face of it, the document appears sound and reliable (07/06/2005, [T-303/03](#), Salvita, EU:T:2005:200, § 42).

As far as the **probative value** of this kind of evidence is concerned, the Office, following the established case-law, makes a distinction between statements coming from the sphere of the opponent themselves or their employees and statements drawn

up by an independent source (09/12/2014, [T-278/12](#), PROFLEX, EU:T:2014:1045, § 51; 06/11/2014, [T-463/12](#), MB, EU:T:2014:935, § 54).

#### Declarations by the proprietor or its employees

Statements coming from the sphere of the owner of the earlier mark (drawn up by the interested parties themselves or their employees) are generally given less weight than independent evidence. This is because the perception of the party involved in the dispute may be more or less affected by personal interests in the matter (11/01/2011, [R 490/2010-4](#), BOTODERM / BOTOX, § 34; 27/10/2009, [B 1 086 240](#) and 31/08/2010, [B 1 568 610](#)).

Such a statement cannot in itself sufficiently prove genuine use (09/12/2014, [T-278/12](#), PROFLEX, EU:T:2014:1045, § 54) However, this does not mean that such statements are totally devoid of all probative value (28/03/2012, [T-214/08](#), Outburst, EU:T:2012:161, § 30). Generalisation should be avoided, since the exact value of such statements always depends on their concrete form and content. Statements including detailed and concrete information have a higher probative value than very general and abstractly drafted statements.

The final outcome depends on the overall assessment of the evidence in each individual case. In general, further material is necessary for establishing evidence of use, since such statements have to be considered as having less probative value than physical evidence (labels, packaging, etc.) or evidence originating from independent sources. Therefore, the probative strength of the further material submitted is very important. An assessment should be made of whether the content of the affidavit is sufficiently supported by the further material (or vice versa). The fact that the national office concerned may adopt a certain practice in assessing such kind of evidence of use does not mean that it is applicable in proceedings concerning European Union trade marks (07/06/2005, [T-303/03](#), Salvita, EU:T:2005:200, § 41 et seq.).

A change of ownership after the filing or priority date of the EUTM application may render declarations made by the new owners void as the latter generally do not have any direct knowledge to form a basis for making declarations concerning use of the mark by the previous owner (17/06/2004, [R 16/2004-1](#), REPORTER / REPORTER).

Nevertheless, in the case of a transfer or other succession in title, any new owner may rely on use by their predecessor(s) within the grace period concerned. Use made by the predecessor may be evidenced by the predecessor and by all other reliable means, for instance, information from business records if the predecessor is not available.

#### Declarations by third parties

Statements (such as e.g. surveys) drawn up **by an independent source**, for example by experts, professional organisations, Chambers of Commerce, suppliers, customers or business partners of the opponent, are given more probative weight (19/01/2011, [R 1595/2008-2](#), FINCONSUM ESTABLECIMIENTO FINANCIERO DE CREDITO / FINCONSUMO (fig.), § 31).

This practice is in line with the case-law of the Court of Justice in the *Chiemsee* judgment (04/05/1999, [C-108/97](#) & [C-109/97](#), Chiemsee, EU:C:1999:230), where the

Court gave some indications of appropriate evidence for proving the acquired distinctiveness of a mark in the market place. Although acquisition of distinctiveness is not per se the same as genuine use, the former does comprise elements of evidence of use of a sign on the market. Consequently, case-law relating to these can be used by analogy.

Statements drawn up by the parties themselves are not 'third-party evidence' whereas all other evidence, such as opinion polls, statements from Chambers of Commerce, or from professional organisations or from experts, does originate from third parties.

## 5.4 Reaction from the applicant

### 5.4.1 Forwarding of evidence

After having received the evidence of use submitted by the opponent, the Office forwards the complete evidence to the applicant.

The Office allows the applicant 2 months to file its observations in reply to the evidence of use (and to the opposition).

### 5.4.2 No evidence or no relevant evidence submitted

However, the Office may close the proceedings immediately if, within the time limit given, the opponent has submitted **no evidence, or the evidence is manifestly of no relevance**, and all earlier trade mark registrations are affected. The rationale behind this practice is to avoid the continuation of proceedings when their outcome is already known, that is, the opposition is to be rejected for lack of proof of use (principle of economy and good administration of proceedings).

Where only some of the earlier marks are subject to the proof of use requirement and the opponent submits no evidence, or the evidence is manifestly irrelevant, the applicant will be invited to submit observations to the opposition in relation to the remaining earlier marks, irrespective of whether it had limited its first observations to requesting proof of use or whether it had also submitted initial observations to the opposition.

In all other cases the evidence is forwarded to the applicant, which is given 2 months to file its observations. The Office must not indicate to the opponent that the sufficiency of the evidence is doubtful, or even invite the opponent to file further evidence in such cases. Such acts would be against the impartial position of the Office in adversarial proceedings (01/08/2007, [R 201/2006-4](#), OCB (fig.) / O.C.B., OCB (fig.), § 19).

### 5.4.3 No reaction from applicant

If the applicant does not react within the time limit, the Office will give a decision on the basis of the evidence before it. The fact that the applicant does not reply does not

mean that it accepts the submitted evidence as sufficient proof of use (07/06/2005, [T-303/03](#), Salvita, EU:T:2005:200, § 79).

#### 5.4.4 Formal withdrawal of the request

Where the applicant reacts to the proof of use by formally withdrawing its request for proof of use, the issue will no longer be relevant. As it is the applicant who sets in motion the respective procedure, the applicant logically is in a position to bring an end to this part of the proceedings by formally withdrawing its request (21/04/2004, [R 174/2003-2](#), SONNENGARTEN / SOMMERGARTEN, § 23).

### 5.5 Further reaction from the opponent

The opponent is entitled to file observations in reply to the applicant's observations. This is of particular importance in cases where the decision to be taken might be based in part on the arguments put forward by the applicant to the effect that the evidence does not prove the use of the mark.

The Board of Appeal has regarded failure to allow the opponent to comment in such a case as a substantial procedural violation (28/02/2011, [R 16/2010-4](#), COLORPLUS, § 20).

For further details on the submission of additional evidence, see [paragraph 5.3.1 above](#).

### 5.6 Languages in proof of use proceedings

According to [Article 10\(6\) EUTMDR](#), where the evidence submitted pursuant to paragraphs 1, 2 and 3 is not in the language of the opposition proceedings, the Office **may** require the opponent to submit a translation of that evidence in that language, within a period specified by the Office.

It is left to the discretion of the Office whether the opponent has to submit a translation of the evidence of use into the language of the proceedings. In exercising its discretion, the Office balances the interests of both parties.

It has to be borne in mind that it might be extremely costly and burdensome for the opponent to translate the evidence of use submitted into the language of the proceedings.

On the other hand, the applicant has the right to be informed about the content of the evidence submitted in order to be capable of defending its interests. It is absolutely necessary that the applicant is able to assess the content of the evidence of use submitted by the opponent. In this regard, the nature of the documents submitted has to be taken into account. For example, it might be considered that 'standard' invoices and samples of packaging do not require a translation in order to be understood by the applicant (15/12/2010, [T-132/09](#), Epcos, EU:T:2010:518, § 51 et seq.; 30/04/2008,

[R 1630/2006-2](#), DIACOR / DIACOL PORTUGAL, § 46 et seq. (appealed 24/01/2017, [T-258/08](#), DIACOR / DIACOL, EU:T:2017:22); 15/09/2008, [R 1404/2007-2](#) & [R 1463/2007-2](#), FAY (fig) / FAY & CO, § 26 et seq.).

If the applicant explicitly requests a translation of the evidence in the language of the proceedings and provides reasons for its request (see [Article 10\(6\) EUTMDR](#) in conjunction with [Article 24 EUTMIR](#)), the Office, in principle, will require a translation from the opponent. However, a rejection of such a request is feasible where it appears that the applicant's request, in view of the self-explanatory character of the submitted evidence, is exaggerated or even abusive.

Where the Office requires translation of the evidence, it gives the opponent a period of 2 months to submit it. Where the evidence of use submitted by the opponent is voluminous, the Office may explicitly invite the opponent to translate only the parts of the submitted material that the opponent regards as sufficient for establishing genuine use of the mark within the relevant period. It is in general up to the opponent to evaluate whether a complete translation of all the evidence submitted is necessary. The evidence will only be taken into account insofar as a translation has been produced or insofar as it is self-explanatory regardless of its textual components.

If the opponent submits evidence of use in a language other than the language of the proceedings within the time limit established for submitting proof of use and then on its own initiative submits a translation of this evidence into the language of the proceedings after the expiry of that time limit, this evidence will be taken into account and forwarded to the applicant for its observations. This applies even if the Office has not required the opponent to file a translation and even if the applicant has not yet contested the evidence.

## **6 Termination of Proceedings**

### **6.1 Friendly settlement**

[Article 47\(4\) EUTMR](#)

[Article 6\(2\) EUTMDR](#)

The parties are free to decide on the measure that brings the opposition proceedings to a conclusion. While they can decide to withdraw the opposition, they can also simply ask the Office to close the case without giving specific reasons. It suffices to communicate the written signed agreement of the parties, which does not have to include a statement of grounds. The Office then takes the steps needed to close the proceedings on the basis of this agreement.

Regarding the refund of fees and decision on costs in case of friendly settlement, please see the relevant paragraph below.

The Office may, if it thinks fit, invite the parties to make a friendly settlement. The Office, as well as the parties, may therefore initiate a settlement procedure.

To this end the Office may issue proposals for friendly settlement. As, in principle, the Office cannot (and does not wish to) replace the parties, it will only take action in cases where a settlement between the parties appears desirable and if there are good reasons for considering that the proceedings can be ended by a settlement.

If expressly requested by the parties, the Office can also offer assistance with their negotiations, for instance by acting as an intermediary or by providing them with any material resources that they need. Any costs incurred are borne by the parties. Friendly settlement may be preceded by a request for suspension.

## 6.2 Restrictions and withdrawals

Articles [66\(1\)](#) and [71\(3\)](#), [Article 146\(6\)\(a\)](#), [Article 146\(9\)](#) and [Article 109 EUTMR](#)  
[Article 6\(2\), \(3\) and \(4\) EUTMDR](#)

### 6.2.1 Restrictions and withdrawals of EUTM applications

[Article 49 EUTMR](#)  
[Article 6\(5\) EUTMDR](#)

It is possible for the applicant to restrict the goods and services of its application or to withdraw the entire application at any stage of the opposition proceedings.

Such requests must be filed by way of separate documents as stated above under [paragraph 4.4.1](#).

Withdrawals and restrictions must be explicit and unconditional. Silence on the part of the EUTM applicant during the proceedings will never be considered as a tacit withdrawal.

A conditional or ambiguous withdrawal or restriction will not be accepted and will be forwarded to the other party merely for information purposes, with the parties being informed that it will not be taken into account.

The Office does not accept conditional restrictions. For example, the applicant argues in its observations in reply to the opposition that the signs are dissimilar but adds that, if the examiner finds them similar, it will restrict the list of goods and services of the EUTM application. In this case, the restriction is not acceptable, and the applicant must be informed that the restriction must be express and unconditional.

If the restriction is not acceptable, even if only in part, the Office will invite the applicant to remedy the deficiency. If the applicant remedies the deficiency, the restriction will be recorded with the effective date of the initial request. If the applicant does not remedy the deficiency, the restriction will be refused in its entirety and the proceedings will



continue on the basis of the original list of goods and services (Guidelines, [Part B, Examination, Section 3, Classification, paragraph 5.3.5](#)). The opponent will be informed about the above steps.

If the opponent withdraws its opposition after an unacceptable restriction has been filed, the withdrawal will not be taken into account if it clearly refers to the unacceptable restriction. Once the restriction has become acceptable, the opponent will be informed of the new list of goods and services and will be granted a new time limit to confirm the withdrawal of the opposition.

If the restriction is acceptable, confirmation is sent to the applicant.

Depending on the moment in the proceedings, the restriction or withdrawal has different consequences, described below.

For further information on restrictions of an EUTM application, see the Guidelines, [Part B, Examination, Section 3, Classification, paragraph 5.3](#) and Part B, Examination, Section 1, Proceedings, paragraphs [5.1](#) and [5.2](#).

#### 6.2.1.1 Withdrawal or restriction before the admissibility check is made

##### Restriction covers the whole extent of opposition/withdrawal

When the EUTM application is withdrawn or restricted to non-contested goods and services before notification regarding admissibility of the opposition has been issued, the opposition proceedings are closed, and the opposition fee is refunded. In other words, dealing with the withdrawal or restriction in such cases takes priority over the admissibility of the opposition.

No decision on costs will be taken.

##### Restriction does not (seem to) cover the whole extent of the opposition

In the case of a restriction that may still include contested goods and services, an admissibility check is done.

The restriction is notified to the opponent together with the notification regarding admissibility or the communication informing the opponent of an absolute or relative admissibility deficiency.

If the opposition is withdrawn, the opposition fee is refunded. This is the case even if irremediable deficiencies exist.

The opponent's letter does not have to expressly refer to the restriction, as long as it is received on or after the date of the applicant's restriction.

No decision on costs will be taken.

#### 6.2.1.2 Restrictions and withdrawals of EUTM applications before the end of the cooling-off period

##### Restriction covers the whole extent of the opposition/withdrawal



When it is absolutely clear that the restriction covers the whole extent of the opposition, or when the EUTM application is withdrawn, this is notified to the parties and the proceedings are closed. The opponent is refunded the opposition fee.

No decision on costs will be taken.

Restriction does not (seem to) cover the whole extent of opposition/withdrawal

If it is not completely clear that the restriction covers the whole extent of the opposition or the restriction does not cover the whole extent of the opposition, the opponent is invited to inform the Office whether it wishes to maintain or withdraw its opposition. The parties are notified of its reply. If the opposition is withdrawn, the opposition fee is refunded to the opponent.

No decision on costs will be taken.

As long as the applicant's restriction is received before the expiry of the cooling-off period, the opposition fee will be refunded, even if the consequent withdrawal of the opposition is received and the proceedings are closed after expiry of the cooling-off period.

Furthermore, if the withdrawal of the opposition is received by the Office before the official notification of the restriction is forwarded to the opponent, the withdrawal is considered to have been made in consequence of the restriction and the opposition fee is also refunded.

The opponent's letter does not have to expressly refer to the restriction, as long as it is received on or after the date of the applicant's restriction.

The initial reaction of the opponent to the notification does not matter, as long as the withdrawal is declared later.

Examples

- The opponent does not reply within the time limit given to it but subsequently withdraws its opposition within the cooling-off period (which has been extended).
- The opponent responds by maintaining its opposition, but nevertheless withdraws the opposition still within the extended cooling-off period.

6.2.1.3 Restrictions and withdrawals of EUTM applications after the end of the cooling-off period

Restriction covers the whole extent of the opposition/withdrawal

When it is absolutely clear that the restriction covers the whole extent of the opposition, or when the EUTM application is withdrawn, this is notified to the parties and the proceedings are closed.

Unless the parties submit an agreement on costs, the Office will take a decision on costs. For information on the apportionment of costs, see [paragraph 6.5.3 below](#).

Restriction does not (seem to) cover the whole extent of opposition/withdrawal

If it is not completely clear that the restriction covers the whole extent of the opposition or the restriction does not cover the whole extent of the opposition, the opponent is invited to inform the Office whether it wishes to maintain or withdraw its opposition. The parties are notified of any reply. If the opposition is maintained, the proceedings continue. If the opposition is withdrawn, the opposition proceedings are closed. If the opponent first maintains its opposition and then subsequently withdraws, this is treated as a withdrawal of the opposition in accordance with [paragraph 6.2.2.2 below](#).

Unless the parties submit an agreement on costs, the Office will take a decision on costs. For information on the apportionment of costs, see [paragraph 6.5.3 below](#).

#### 6.2.1.4 Restrictions and withdrawals of EUTM applications after a decision has been taken

Following the decision of the Grand Board of Appeal of 27/09/2006 in [R 331/2006-G](#), Optima, the Office accepts withdrawals and restrictions received during the appeal period after a decision on the opposition has been rendered, even if no appeal has been filed.

The Office will take note of the withdrawal and close the case. Confirmation of the withdrawal is sent to the parties (however, no decision on costs is included in this communication). The part on costs of the initial decision remains valid and could be enforced by the winning party unless a different agreement is reached. The Office's database is updated accordingly to reflect the withdrawal of the EUTM application.

For further information, see the Guidelines, [Part B, Examination, Section 1, Proceedings, paragraph 5.1](#) and [Part E, Register Operations, Section 2, Conversion, paragraph 4.3](#).

An EUTM application cannot be withdrawn once a decision rejecting the EUTM application in full has become final.

If the decision rejected the opposition, the application can be withdrawn or restricted at any time.

The **withdrawal of any pending appeal** (before the Boards of Appeal, the General Court or the Court of Justice) means that the **contested decision becomes final**. Consequently, the contested EUTM application may no longer be withdrawn thereafter.

#### 6.2.1.5 Language

<a href="#">Article 146(6)(a) EUTMR</a>
---

During opposition proceedings a restriction may be submitted either in the first or the second language of the EUTM application.

When the restriction is submitted in the first language of the EUTM application, which is not the language of proceedings, and when the restriction does not cover the whole extent of the opposition, the restriction is forwarded to the opponent, requesting it to inform the Office whether or not it maintains its opposition. The opponent can object to

the language of the restriction and ask for a translation into the language of proceedings. The Office will then provide for the translation.

If an acceptable restriction is submitted in the first and the second language, the examiner must reflect this restriction in the two languages in the Office's database and confirm the new list of goods and services in the two languages to the applicant.

## 6.2.2 Withdrawal of oppositions

The opponent can withdraw its opposition at any time during the proceedings.

A withdrawal of the opposition must be explicit and unconditional. A conditional or ambiguous withdrawal will not be accepted and will be forwarded to the applicant merely for information purposes, with the parties being informed that it will not be taken into account.

If the opponent withdraws its opposition independent of any restriction of the EUTM application, three situations can arise depending on the status of the opposition. For information about the consequences of the withdrawal of an opposition because of a restriction of the EUTM application, see paragraphs [6.2.1.1-6.2.1.3](#) above.

### 6.2.2.1 Withdrawal of the opposition before the end of the cooling-off period

If the opposition is withdrawn before the end of the cooling-off period, the parties are notified. Unlike in the event of a withdrawal of the opposition following a restriction of the EUTM application during the cooling-off period (see [paragraph 6.2.1.2 above](#)), the Office neither refunds the opposition fee nor takes a decision on costs.

### 6.2.2.2 Withdrawal of the opposition after the end of the cooling-off period

If the opposition is withdrawn after the end of the cooling-off period the parties are notified. The opposition fee is not refunded. Unless the parties submit an agreement on costs, the Office will take a decision on costs. For information on the apportionment of costs, see [paragraph 6.5.3 below](#).

### 6.2.2.3 Withdrawal of the opposition after a decision has been taken

Following the decision of the Grand Board of Appeal of 27/09/2006 in [R 331/2006-G](#), Optima, the Office accepts withdrawals of the opposition received during the appeal period after a decision on the opposition has been taken, even if no appeal has been filed.

The Office will take note of the withdrawal and close the case. Confirmation of the withdrawal is sent to the parties, without any decision on costs being included in this communication. The part on costs of the initial decision remains valid and can be enforced by the winning party. The Office's database is updated accordingly to reflect the withdrawal of the opposition, and the application proceeds to registration.

The **withdrawal of any pending appeal** (before the Boards of Appeal, the General Court or the Court of Justice) means that the **contested decision becomes final**. Consequently, the opposition may no longer be withdrawn thereafter.

For further information on withdrawals during appeal proceedings, see the Guidelines, [Part B, Examination, Section 1, Proceedings, paragraph 5.1](#).

#### 6.2.2.4 Language

#### [Article 146\(9\) EUTMR](#)

A withdrawal of the opposition must be in the language of the proceedings. Should the withdrawal be submitted in a language that is not the language of proceedings a translation must be filed within 1 month from the date of submission of the original document. Otherwise, the withdrawal will be refused.

#### 6.2.3 Withdrawals of withdrawals/restrictions

A party is only permitted to withdraw a previously submitted withdrawal/restriction if the Office receives its letter withdrawing the earlier withdrawal/restriction on the same day as the first submission (see also the Guidelines, [Part B, Examination, Section 1, Proceedings, paragraph 5.2.1](#)).

### 6.3 Decision on substance

The decision on substance is taken only once the parties have submitted all that is required, and should deal only with those issues or earlier rights that are relevant for the outcome.

There are two exceptions, which are when:

- the earlier right is not proven;
- the earlier right has ceased to exist.

#### 6.3.1 Earlier right not proven

#### [Article 8\(1\) EUTMDR](#)

If proof of existence, validity and scope of protection has not been filed properly for any of the earlier rights invoked, the opposition is rejected as soon as the time limit given to the opponent to complete its file has expired.

However, if the existence, validity and scope of protection of at least one earlier right have been proven, the proceedings will continue normally, and the non-substantiated rights will not be taken into account in the final decision on substance.

### 6.3.2 Earlier right has ceased to exist

If, in the course of the proceedings, the earlier right ceases to exist (e.g. because it has been declared invalid, or it has not been renewed), the final decision cannot be based on it. The opposition may only be upheld with respect to an earlier right that is valid at the moment when the decision is taken. This is because the requirement to refuse registration of a trade mark if any of the grounds of opposition applies is worded in the present tense in [Article 8 EUTMR](#), which requires the presence of a conflict at the time when the decision is taken. The reason why the earlier right ceases to have effect does not matter.

Invalidation of any earlier right other than an EUTM cannot be detected by the Office. However, if one of the parties informs the Office of such invalidation, the other party must be heard, and it may be that the opposition will not be able to proceed on the basis of that earlier right.

Before the decision is taken, the Office will check whether the earlier right invoked has become due for renewal in the meantime. If so, the Office will invite the opponent to prove the renewal of the mark. This applies even if the mark is still within the grace period for renewal, if applicable. If the opponent does not submit the proof, the opposition will not be able to proceed on the basis of that earlier right.

Before the decision is taken, the Office may also check the documents on file to see whether the earlier right invoked is the subject of national post-registration proceedings. If so, the Office will invite the opponent to submit evidence of the final outcome of the national proceedings. If the opponent submits evidence showing that the national proceedings are still pending, the Office may suspend the opposition proceedings until a final decision has been taken in the proceedings that led to the suspension.

## 6.4 Fee refund

### 6.4.1 Opposition deemed not entered

Articles [46\(3\)](#) and [181\(1\)](#) EUTMR

[Article 5\(1\) EUTMDR](#)

If an opposition is deemed as not entered because of late or insufficient payment (see [paragraph 2.2.2 above](#)), the opposition fee, including any surcharge, must be refunded to the opponent.

#### 6.4.1.1 Opposition and withdrawal of the opposition filed the same date

In cases where the opposition is withdrawn the same day it was filed, the Office refunds the opposition fee.

#### 6.4.1.2 Refund after republication

If, after republication of the EUTM application in Part A.2 of the Bulletin due to a mistake by the Office, a 'first publication opponent' wishes to withdraw its opposition as a consequence of the republication, the proceedings should be closed. As the Office made a mistake with the first publication, the opposition fee will be reimbursed.

#### 6.4.2 Refund in view of withdrawals/restrictions of the EUTM application

##### [Article 6\(2\), \(3\), \(4\) and \(5\) EUTMDR](#)

##### 6.4.2.1 EUTM application withdrawn/restricted before end of cooling-off period

If the applicant withdraws its EUTM application or withdraws all those goods and services against which the opposition is directed before or during the cooling-off period, the opposition proceedings are closed, there is no decision on costs, and the opposition fee must be refunded (see paragraphs [6.2.1.1](#) and [6.2.1.2](#) above).

##### 6.4.2.2 Opposition withdrawn due to restriction of EUTM application within cooling-off period

If the applicant withdraws some of the goods and services against which the opposition is directed during the cooling-off period, the Office invites the opponent to state whether it maintains the opposition (and, if so, against which of the remaining goods and services) or whether it withdraws it in view of the restriction.

If the opposition is then withdrawn, the opposition proceedings are closed, there is no decision on costs, and the opposition fee must be refunded (see paragraphs [6.2.1.1](#) and [6.2.1.2](#) above).

#### 6.4.3 Multiple oppositions and refund of 50 % of opposition fee

##### [Article 9\(4\) EUTMDR](#)

In certain special cases concerning multiple oppositions, it is possible to refund 50 % of the opposition fee to an opponent. Two conditions must be met, as illustrated in the following example.

- One of the opposition proceedings was terminated by the rejection of the contested EUTM application in parallel opposition proceedings. For example, there are four oppositions A, B, C and D (opponents A, B, C, D) against EUTM application X, and EUTM application X is rejected due to opposition A.
- The other oppositions (B, C and D) had been suspended before the commencement of the adversarial part (because a preliminary examination revealed that EUTM application X would probably be rejected in its entirety because of opposition A).

In this case, opponents B, C and D are refunded 50 % of the opposition fee.

#### 6.4.4 Cases where the opposition fee is not refunded

##### 6.4.4.1 Opposition withdrawn before the end of the cooling-off period NOT due to a restriction

###### [Article 6\(3\), \(4\) and \(5\) EUTMDR](#)

If the opponent withdraws its opposition before the end of the cooling-off period and there has been no restriction of the EUTM application, the Office neither refunds the opposition fee nor takes a decision on costs (see [paragraph 6.2.2.1 above](#)).

##### 6.4.4.2 Opponent's withdrawal is earlier

###### [Article 6\(3\) and \(5\) EUTMDR](#)

When the opposition is withdrawn before the applicant restricts its application, the fee is not refunded (see paragraphs [6.2.1.1](#) and [6.2.1.2](#) above). Additionally, if the applicant withdraws its application following (e.g. as a reaction to) the withdrawal of the opposition, the fee is not refunded.

The same applies when the applicant restricts the application following a partial withdrawal of the opposition.

##### 6.4.4.3 Settlement between the parties before commencement of proceedings

###### [Article 6\(2\), \(4\) and \(5\) EUTMDR](#)

As regards the refund of the opposition fee, [Article 6\(5\) EUTMDR](#) only mentions this possibility if there is either a withdrawal or a restriction of the EUTM application. Therefore, if the proceedings end by an agreement that contains a mention of a withdrawal or restriction of the EUTM application, the opposition fee is refunded. In the other cases, the opposition fee is not refunded.

##### 6.4.4.4 Termination of proceedings for other reasons

###### [Articles 7 and 45 and Article 119\(2\) EUTMR](#)

###### [Articles 5 and 6 EUTMDR](#)

In cases where the application is rejected in accordance with:

- [Article 7 EUTMR](#) (rejection of an application on absolute grounds; on the Office's own initiative or because of third party observations), or

- [Article 119\(2\) EUTMR](#) (representation for non-EEA applicants),

the opposition fee is not refunded as none of these situations is contemplated in the EUTMDR as a reason for refunding the opposition fee.

## **6.5 Decision on the apportionment of costs**

### **6.5.1 Cases in which a decision on costs must be taken**

[Article 109 EUTMR](#)

[Article 6\(4\) EUTMDR](#)

A decision on costs is taken in opposition proceedings that have passed the cooling-off period, that is to say, where the adversarial part of the proceedings has both started and come to an end.

If a decision on substance is taken, the decision on apportionment of costs is given at the end of the decision. In all other cases where the Opposition Division closes the case, a decision on costs is issued together with the closure letters unless the parties have informed the Office about an agreement on costs.

### **6.5.2 Cases in which a decision on costs is not taken**

No decision on costs is taken for oppositions that are closed before or during the cooling-off period.

#### **6.5.2.1 Agreement on costs**

[Article 109\(6\) EUTMR](#)

Whenever the parties have settled the opposition proceedings with an agreement that includes the costs, the Office will not issue a decision on costs. The same is true if the Office receives information signed by both parties stating that the parties have agreed on costs. Such a request can also be sent in two separate letters to the Office. This information must be received before the Office has confirmed the closure of the proceedings.

If the parties settle the opposition by mutual agreement, they are free not to include the cost issue. If no indication is given as to whether the parties have agreed on the costs, the Office will take a decision on costs immediately, together with its confirmation of the withdrawal/restriction. If the parties inform the Office that they have reached an agreement on costs after the withdrawal/restriction, the decision already issued on costs will not be revised by the Office. It is left to the parties to respect the agreement and not to 'execute' the Office's decision on costs.



#### 6.5.2.2 Information from potential 'successful party'

When the party that would be entitled to be awarded costs according to the general rules described in [paragraph 6.5.3](#) below informs the Office that it accepts each party bearing their own costs, no decision on costs is necessary. The Office will refrain from taking a decision on costs whenever the potential 'successful party' informs the Office that it agrees to share the costs, even if the 'losing party' does not confirm its agreement. The latest letters from both parties therefore have to be checked carefully before issuing a decision.

However, any such request sent by the losing party to the Office will simply be forwarded to the other party, and the decision on costs will be taken *ex officio* under normal rules.

#### 6.5.3 Standard cases of decisions on costs

##### [Article 109 EUTMR](#)

The general rule is that the losing party or the party that terminates the proceedings, whether by withdrawing the EUTM application (wholly or partially) or by withdrawing the opposition, will bear the fees incurred by the other party as well as all costs incurred by it that are essential to the proceedings.

If both parties lose in part, a 'different apportionment' has to be decided. As a general rule, it is equitable that each party bears its own costs.

A party that terminates the proceedings is deemed to have given in. The hypothetical outcome of the case if a decision on substance had become necessary is absolutely irrelevant.

In standard cases the result is the following.

- The applicant withdraws or restricts its application to the goods and services the opposition is not directed at (partial withdrawal). In these cases the applicant has to pay the costs.
- The opponent withdraws its opposition without any restriction of the EUTM application as regards the contested goods and services after the cooling-off period. The opponent has to pay the costs.
- Restriction of the application followed by withdrawal of the opposition (28/04/2004, [T-124/02](#) & [T-156/02](#), Vitataste, EU:T:2004:116, § 56). In principle each party bears its own costs.

A different apportionment of costs can, however, be justified for reasons of equity (for example, if the application was restricted only to a very small extent).

The Office will not take into account parties' arguments as to who should pay.

## 6.5.4 Cases that did not proceed to judgment

### 6.5.4.1 Multiple oppositions

#### Complete rejection of the EUTM application

In cases where there are multiple oppositions against the same EUTM application that have not been suspended by the Office in accordance with [Article 9\(2\) EUTMDR](#), and one opposition leads to the rejection of the EUTM application, the Office does not take any action in the other oppositions until the appeal period has elapsed.

If the appeal period elapses without an appeal being filed, the Office closes the other opposition proceedings and the cases do not proceed to judgment.

In this case, the determination of costs is at the discretion of the Opposition Division ([Article 109\(5\) EUTMR](#)). The Office is not able to determine who the 'winning or losing party' is, and the applicant should not be required to pay the costs of several other opponents if it loses in one decision on substance. Therefore, applying a principle of equity, each party will be ordered to bear its own costs.

#### Partial rejection of the EUTM application

In cases of multiple oppositions that are partially directed against the same goods and services of the contested trade mark, the opposition decision taken first may affect the other oppositions.

#### Example

Opposition A is directed against Class 1 and opposition B against Classes 1 and 2 of the contested EUTM application. A decision is taken first in opposition A rejecting the contested application for Class 1. When the decision is notified to the parties of opposition A, opposition B must be suspended until the decision in opposition A is final and binding. Once the decision is final, the opponent of opposition B will be invited to inform the Office whether it wishes to maintain or withdraw its opposition in view of the amendment of the list of goods. If the opponent withdraws the opposition, the case is closed.

In this situation, and if the case is closed after commencement of the adversarial part of the proceedings, the Office will issue a decision on costs in accordance with [Article 109\(3\) EUTMR](#). The opponent withdrew its opposition following the partial rejection of the contested trade mark. To this extent the opponent was successful in the proceedings. However, the partial rejection of the trade mark was more restricted than the scope of the opposition. To this extent the applicant/holder was also successful in the proceedings. Consequently, it is equitable that each party should bear its own costs.

If the opponent maintains its opposition after the partial rejection, the proceedings continue and in the final decision on the substance the decision on costs is taken according to the normal rules.

#### 6.5.4.2 Rejection of an application on the basis of absolute grounds or formalities

An EUTM application can be rejected during an opposition procedure on absolute grounds for refusal (either on the basis of third party observations, [Article 45 EUTMR](#), or *ex officio* if the case is reopened) or on formalities (e.g. if an applicant from outside the EEA is no longer represented under [Article 119\(2\) EUTMR](#)).

Once the rejection becomes final, the opposition proceedings are closed by issuing a notification.

In these situations the practice on costs is as follows.

If the refusal becomes final after the expiry of the cooling-off period, a decision on costs is taken pursuant to [Article 109\(5\) EUTMR](#). If the same situation arises before commencement of the adversarial part, no decision on costs is to be taken.

#### 6.5.4.3 Cases of joinder

##### [Article 9 EUTMDR](#)

For further information on joinder, see [paragraph 7.4.3, Joinder of proceedings](#), below.

In cases where the joint opposition succeeds in its entirety the applicant should pay the opposition fees paid by each of the opponents but representation costs only once. If the applicant wins, its representation costs will be awarded once but each of the joint opponents will be liable for them. A different apportionment of costs might be equitable. In cases of partial success or if equitable for other reasons, each party should bear its own costs.

#### 6.5.4.4 The meaning of 'bear one's own costs'

The notion of costs comprises the opposition fee and the costs essential to the proceedings, as referred to in [Article 109\(1\) EUTMR](#). In most cases the costs cover the remuneration of an agent within the limits of the scales set by the Regulation.

'Each party shall bear their own costs' means that no party has a claim against the other party.

## 6.6 Fixing of costs

##### [Article 109\(1\), \(2\), \(7\) and \(8\) EUTMR](#)

##### [Article 18 EUTMIR](#)

Where the costs are limited to representation costs and the opposition fee, the decision fixing the amount of costs will be included in the decision on the apportionment of the

costs (i.e. as a rule, in the decision on substance), except where the parties are ordered to bear their own costs.

This means that in the vast majority of cases, it will not be necessary to fix the amount of costs separately.

The only exceptions are:

- when an oral hearing took place;
- when the fixing of costs was inadvertently omitted ('forgotten') in the main decision.

#### 6.6.1 Amounts to be fixed

The costs to be borne comprise (i) the opposition fee and (ii) the costs essential to the proceedings, as referred to in [Article 109\(1\) EUTMR](#). They are always fixed in euros, regardless of the currency in which the party had to pay its representative.

The opposition fee is EUR 320 (as laid down in the [Annex](#) to the EUTMR).

The costs essential to the proceedings include the costs of representation, travel and subsistence. In the absence of an oral hearing, only the costs of representation are relevant.

As regards representation costs, the amount is limited to EUR 300. This applies both to the opponent and the applicant, provided that they were represented in the opposition procedure by a professional representative within the meaning of [Article 120\(1\) EUTMR](#), irrespective of whether these costs have actually been incurred. If the winning party was represented at some stage of the proceedings by a professional representative, but is no longer represented at the time of taking the decision on costs, it is also entitled to an award of costs regardless of when in the proceedings professional representation ceased.

Representation costs for employees, even from another company with economic connections, are not reimbursable and will not be fixed. They will not be addressed in the decision on costs.

For further information on representation, see the Guidelines, [Part A, General Rules, Section 5, Parties to the Proceedings and Professional Representation](#).

In the case of a joinder under [Article 9\(1\) EUTMDR](#), where the oppositions are successful, the Office will fix both (or all) opposition fees (one for each opposition) but only one representation fee.

As regards the costs of the opposition procedure, one single decision on the apportionment and on the fixing of costs must be taken for the opposition procedure as a whole.

When a decision is annulled by the Boards of Appeal and remitted to the Opposition Division, the Opposition Division has to decide on the case again and will take a decision on and fix the costs in the usual way.

If this decision is appealed again (and not remitted for a second time) the Board will decide on and fix the costs in the usual way.

## 6.6.2 Procedure if the fixing of costs is contained in the main decision

Where the decision fixing the amount of costs is included in the decision on the apportionment of the costs, no bill or proof whatsoever is needed. The Office knows that the opposition fee was paid and, if there is a representative, EUR 300 must be awarded irrespective of any evidence.

Therefore, no correspondence with the parties about the amount to be fixed is necessary. The fixing of the amount is automatic.

## 6.6.3 Procedure if a separate fixing of costs is needed

The following procedural requirements apply in the rare cases where a separate fixing of costs must be made (including when it was inadvertently omitted, in which case the party concerned must also comply with the applicable requirements):

- admissibility
- evidence.

### 6.6.3.1 Admissibility

The request for fixation of costs is only admissible once the decision in respect of which the fixing of costs is required has become final and up to 2 months after that date.

### 6.6.3.2 Evidence

For awarding the opposition fee, no evidence is needed.

For awarding the representation costs at the standard rate, an assurance by the representative that the costs have been incurred is sufficient. A fortiori, if a bill is presented, it suffices that it shows at least the reimbursable amount; it does not matter whether or not it is addressed to the party to the proceedings, as submitting a bill equals an assurance.

For all other costs (which will apply in extremely rare cases), a bill and supporting evidence are needed, but it suffices that these make it plausible (rather than provide fully fledged proof) that the costs have been incurred.

## 6.6.4 Review of fixing of costs

If one of the parties disagrees with the amounts fixed, it can ask for a review of the decision. The request must state the reasons and be filed within 1 month of the date of notification of the fixation. The request is only deemed to be filed when the fee for review of EUR 100 has been paid.

There are no reimbursable costs in the review procedure (16/12/2004, [R 503/2001-4](#), BIOLACT / BIO).

## 7 Other Procedural Issues

### 7.1 Correction of mistakes

#### [Article 49\(2\) EUTMR](#)

##### 7.1.1 Correction of mistakes in the notice of opposition

There are no special provisions in the Regulations regarding the correction of mistakes in the notice of opposition. Applying [Article 49\(2\) EUTMR](#), which refers to the EUTM application, by analogy, obvious mistakes in the notice of opposition may be corrected.

For information on corrections in the name and address of an opponent or its representative, see the Guidelines, [Part A, General Rules, Section 5, Parties to the Proceedings and Professional Representation, paragraph 11](#).

##### 7.1.2 Correction of mistakes and errors in publications

#### [Article 44\(3\) EUTMR](#)

Where the publication of the application contains a mistake or error attributable to the Office, the Office will correct the mistake or error on its own initiative or at the request of the applicant.

The corrections effected under this rule have to be published. If the correction concerns mistakes that do not affect the opposition, it will be published when the EUTM is registered. Where the correction leads to an extension of the list of goods or services or concerns the representation of the mark, a new opposition period is opened, but only in respect of the corrected parts.

If oppositions were filed after the 'first' publication of the EUTM application, the opponents will have to be informed of the republication. The opponents that opposed the 'first' publication do not have to file a new opposition. The proceedings must be suspended until the opposition period following the 'second' publication has expired.

If a 'first publication opponent' wishes to withdraw its opposition as a consequence of the republication, the proceedings should be closed and the opposition fee should be refunded (see [paragraph 6.4.1.2 above](#)).

## 7.2 Time limits

[Article 101](#) and [Article 146\(9\) EUTMR](#)

Articles [63](#) and [68](#) EUTMDR

Time limits are an essential tool for conducting orderly and reasonably swift proceedings. They are a matter of public policy, and rigorous compliance with them is necessary for ensuring clarity and legal certainty.

For general information on time limits and continuation of proceedings, see the Guidelines, [Part A, General Rules, Section 1, Means of Communication, Time Limits](#).

### 7.2.1 Extension of time limits in opposition proceedings

#### 7.2.1.1 Non-extendable and extendable time limits

A time limit cannot be extended if its length is set by the Regulations. Non-extendable time limits include:

- the 3-month opposition period to file an opposition ([Article 46\(1\) EUTMR](#));
- the 3-month time limit to pay the opposition fee ([Article 46\(3\) EUTMR](#));
- the 1-month time limit to pay the surcharge when payment arrives late and no proof is made that it was initiated at least 10 days before expiry of the time limit for payment ([Article 141\(3\) EUTMR](#));
- the 2-month time limit to remedy deficiencies ([Article 5\(5\) EUTMDR](#)).

The length of **extendable** time limits is specified by the Office. For example, the time limit to submit observations in reply to the notice of opposition is an extendable time limit.

#### 7.2.1.2 Conditions of the request

Note that extensions of the cooling-off period have a special regime. For further details, see above under [paragraph 3.2, Extension of the cooling-off period](#).

The request for extension has to fulfil the following conditions:

- the time limit must be extendable;
- the extension has to be requested by the party concerned;
- the request has to be signed (if submitted by electronic means, the indication of the name of the sender is deemed to be equivalent to its signature);
- the request must be received by the Office at the latest on the date of expiry of the time limit;
- the language regime must be respected (i.e. if the request is not in the language of the proceedings, a translation must be submitted within 1 month of filing; otherwise the request will not be taken into account).

An extension will only be possible if the relevant request is filed and received before the expiry of the original term. If a request for extension is received by the Office after the expiry of the time limit, it must be rejected.

As a general rule, the first request for an extension that is received in time will be considered appropriate and will be granted for a period equal to the original term (or less, if so requested). However, any subsequent request for an extension of the same time limit will be refused, unless the party requesting it duly explains and justifies the exceptional circumstances that prevented it from meeting the original time limit and the first extension, and why a further extension is necessary. General or vague explanations will not justify a second extension. The request must always be accompanied by evidence and/or supporting documentation.

Circumstances that are within the control of the party concerned are not 'exceptional circumstances'. For example, last-minute discussions with the other party are not 'exceptional circumstances'. They are within the control of the parties.

The request has to be filed by the party affected by the time limit. For example, if the applicant has to submit observations in reply to the notice of opposition, it can only be the applicant that asks for an extension.

This does not preclude the requesting party from obtaining the other party's written consent to the request. However, **consent** provided by the other party does not divest the Office of its **power of discretion** as to whether to allow such extension. In any event, the consent given by the other party will be duly considered by the Office in the exercise of its discretion.

For the consent of the other party to be taken into account, it is not sufficient that the requesting party assures the Office that such consent was given. The other party must express its consent by separate submission or by signing the requesting party's submission. In the latter case, if submitted by electronic means, the indication of the name of the sender is deemed to be equivalent to its signature; however, the signature of the other party must be present in order for the consent to be acceptable.

For more information on extensions of time limits, consult the Guidelines, [Part A, General Rules, Section 1, Means of Communication, Time Limits](#).

#### 7.2.1.3 Extension of a time limit by the Office on its own initiative

The Office can extend a time limit on its own initiative, if and when particular reasons make it necessary. For example, a request to extend a time limit without any justification is received by the Office 20 days before the end of the time limit to file observations but is not dealt with until after expiry of the time limit. Because refusal of the request after expiry of the time limit will disproportionately harm the interests of the party who requested the extension, the Office extends the time limit by the number of days that were left when the party submitted its request, in this case 20 days. This practice is based on the rules of fair administration.



Where a request for extension of an extendable time limit is filed and received before expiry of the time limit, the party concerned will be granted at least 1 day, even if the request for extension arrived on the last day of this time limit.

## 7.3 Suspension

[Article 71](#) and [Article 9\(2\) EUTMDR](#)

The Office can suspend opposition proceedings either *ex officio* or at the request of either one or both parties.

### 7.3.1 Suspension requested by both parties

According to [Article 71\(2\) EUTMDR](#), if both parties request the suspension of the proceedings after expiry of the cooling-off period, the suspension will be granted, without any need for the request to be justified. In this case, and regardless of the period requested by the parties, the first suspension will be granted for a period of 6 months, with the parties being given the possibility of opting out. The process for opting out is the same as for the extension of the cooling-off period: if one party opts out, the suspension will end 14 days after the parties have been informed thereof. The proceedings will resume the day after, and the party whose time limit was pending at the moment of suspension will be granted the same period of time in full. It is not possible to opt out during the last month of the suspended period, and any requests to do so will be rejected.

A joint request for suspension will not be granted if it is received within the cooling-off period, because the purpose of the cooling-off period is to set a time frame for negotiations before the adversarial stage begins.

Upon a joint request by the parties, the suspension will be extended, without any need for the request to be justified.

However, the maximum duration of this suspension of the proceedings is limited to 2 years, as set out in [Article 71\(2\) EUTMDR](#) — a duration that is to be understood as 2 years cumulative over the course of the proceedings.

Such joint requests for the extension of a suspension will be granted for further 6-month periods (regardless of the period requested by the parties, but with the possibility of opting out) or for the remaining time if less than 6 months remain out of the total maximum of 2 years. A joint request for suspension will be rejected as inadmissible if the parties have used up the total maximum of 2 years.

### 7.3.2 Suspensions by the Office *ex officio* or at the request of one of the parties

The Office may suspend the opposition proceedings *ex officio* or at the request of one party under a variety of circumstances, for example where:

- the opposition is based on an application for registration of a trade mark (including conversion);
- the opposition is based on an application for registration of a geographical indication or designation of origin.
- the earlier right is at risk (under opposition or cancellation);
- there are third-party observations that raise serious doubts as to the registrability of the EUTM application (see [paragraph 4.6](#) above);
- there are errors in the publication of a contested application that require the mark to be republished;
- a transfer is pending on earlier EUTMs/EUTM applications or contested EUTM applications;
- a deficiency has been raised in connection with the restriction of a contested application;
- a deficiency has been raised in connection with professional representation.

It should be noted that there is no obligation in any of the abovementioned cases to suspend the proceedings. The Office will decide whether suspension is appropriate under the circumstances of each case. Therefore, the decision is at the Office's discretion. If requested by one of the parties, the request must be duly justified. Ongoing negotiations between the parties do not constitute an appropriate justification for a suspension requested by only one of the parties.

The proceedings will normally be suspended until the completion of the proceedings that led to the suspension. The limitation as to the total duration of suspension set out in [Article 71\(2\) EUTMDR](#) does not apply.

#### 7.3.2.1 Explanation of the basic principle, timing of suspension

##### [Article 71\(1\)\(a\) and \(b\) EUTMDR](#)

In principle, oppositions based on (i) applications or (ii) earlier rights that are at risk are not to be suspended *ex officio* at the very beginning of the proceedings. The assumption is that in most cases applications mature into registrations, and oppositions or cancellation actions against earlier rights might be solved during the proceedings.

In these cases, the opposition proceeds until a decision is ready to be taken. Consideration must then be given as to whether the earlier right in question could make a difference, in a prima facie opinion, to the outcome of the opposition. If the opposition is deemed to be successful or rejected anyway, regardless of the fate of the earlier right at risk, the proceedings should not be suspended. If, in contrast, the earlier right at risk must necessarily be taken into account in the decision on the opposition, the proceedings will be suspended and, in the case of a national application or an earlier national mark at risk, the opponent must be requested to provide information on the status of the application or registration. For earlier EUTMs, the Office has this information at its disposal.

However, the Office may suspend the proceedings earlier if this is **requested by one of the parties** and the earlier right is an application or is at risk. If the earlier right is a

national one, the parties must submit evidence that it is facing problems. In this case the outcome of the proceedings against the earlier mark must have some impact on the opposition. Therefore, the probable outcome of the opposition will be considered in order to decide on suspension — in particular, whether the final decision on the opposition cannot be issued without taking into account the earlier application or earlier registration. This will be the case if the circumstances of the case do not allow the Office to say that the opposition will be rejected (e.g. because there is no likelihood of confusion) or upheld (because there are other earlier rights that are sufficient to reject the contested mark for all the contested goods and services).

When an opposition is based on an application for registration, it may be appropriate to suspend the opposition proceedings under [Article 71\(1\)\(a\) EUTMDR](#) to await registration of the opponent's earlier mark. However, if an opposition is to be rejected, either for formal or for substantive reasons, a suspension would be meaningless and would simply prolong the proceedings unnecessarily.

When there are no other earlier rights to take into account (because there are no other earlier rights or they were not substantiated) or when the application or registration must nevertheless be taken into account (because the other earlier rights are not 'winners'), an assessment must be made of whether the opposition will be successful on the basis of the application, in order to decide on the suspension. Proceedings will only be suspended if it is found that the earlier application, if registered, will lead to the total or partial rejection of the contested EUTM application.

#### 7.3.2.2 Earlier EUTM applications or registrations

In this case, the opposition is based on an application but is not suspended because there is another earlier right (a registered trade mark) on the basis of which the contested application may be rejected. If the opponent fails to substantiate this other earlier right, the earlier application becomes crucial for the decision. If, according to the records, the only earlier application or registration is facing problems, the opposition should be suspended.

#### 7.3.2.3 Earlier national/international marks (applications or registrations/rights)

In this case, the issue of suspension will have to be raised by the parties (normally the applicant) and evidence will have to be submitted that the earlier mark (application or registration/right) is facing problems. This evidence must be official, it must clearly identify the proceedings leading to the suspension, and it must indicate the relief sought. In particular, the evidence must be clear as to the possible consequences for the earlier right on which the opposition is based. If necessary, the party concerned may be requested to submit a translation of the evidence.

Upon such a request the Office will consider whether, under the circumstances of the case, it is advisable to suspend the proceedings.

If no party raises the question of suspension, then the general principle applies and the Office only has to decide on suspension if the proceedings reach the end of the

adversarial part and there is no information that the application has matured to registration or that national proceedings against the earlier mark have come to an end. In this case the opponent should be required to inform the Office of the status of its earlier application or registration.

#### 7.3.2.4 Examples

Here are some examples where, according to the general practice indicated above, the situation apparently does not require the proceedings to be suspended but they can be if the Office finds it appropriate.

- The opposition is based on a French mark and on an EUTM application, neither of which faces problems. Both cover the same sign and the same goods, which are confusingly similar to the contested trade mark. Therefore, the opposition may be dealt with on the basis of the French mark only. If likelihood of confusion can occur only in Member States other than France, the decision will be more solid if based on the EUTM application. Therefore, it is appropriate to suspend the proceedings to await the outcome of the EUTM application.
- The earlier application does not make any difference to the outcome, but the applicant requests a suspension. If the earlier right is an EUTM application and the Office concludes that it is facing problems or, in the case of a national application, if the applicant submits evidence that the opponent's application is facing problems, the proceedings may be suspended.

The following examples fall into the category of earlier national marks facing problems:

- the applicant (or a third party) has filed an action or a counterclaim seeking the invalidation or revocation of the earlier registration;
- the applicant (or a third party) has filed an action or a counterclaim seeking the transfer of the earlier right to its own name.

#### 7.3.3 Multiple oppositions

##### [Article 9\(2\) EUTMDR](#)

Except under exceptional circumstances, such as where one opposition clearly leads to the rejection of the contested mark including all goods and services, the Office will not suspend the other proceedings.

##### 7.3.3.1 After rejection of the EUTM application

When the EUTM application is subsequently rejected because of an 'active' opposition, the suspended oppositions are deemed to have been disposed of after the decision becomes final. If the decision has become final, the parties to the other proceedings must be informed, the oppositions that were suspended at an early stage (before the commencement of the adversarial part of the proceedings) will be closed, and 50 % of

the opposition fee will be refunded to each opponent, in accordance with [Article 9\(4\) EUTMDR](#).

If an appeal has been filed against the decision, the oppositions remain suspended. If the Board of Appeal reverses the decision, the other proceedings will be resumed immediately, without having to wait for that decision to become final.

#### 7.3.4 Procedural aspects

Letters suspending the proceedings should always indicate the date the suspension takes effect — generally the date when a valid request was submitted.

##### 7.3.4.1 Monitoring suspended files

In cases where the proceedings are suspended for an undefined period, the Office will monitor the opposition every 6 months.

Where the earlier right is an application for a national registration or a national/international registration at risk, the parties are expected to promptly inform the Office about any change in the status of the proceedings affecting the application or registration and submit evidence to this effect. Nevertheless, the Office will consult the online evidence referred to in the notice of opposition every 6 months. Where it appears that the pending proceedings affecting the earlier right have concluded, it will resume the proceedings. Alternatively, it will request the parties to provide an update.

##### 7.3.4.2 Resuming the proceedings

In all cases the parties will be informed of the resumption of the proceedings and of any pending time limit, if applicable. Any time limit that was pending at the moment of the suspension will be re-set in full, with the exception of the cooling-off period, which can never exceed 24 months according to [Article 6\(1\) EUTMDR](#).

Proceedings must be resumed as soon as a final decision has been rendered in the course of the national proceedings or an earlier application has been registered or refused. If a decision taken in national proceedings invalidates, revokes, or in some other way extinguishes a right, or transfers an opponent's earlier right, the opposition is deemed unfounded insofar as it is based on that earlier right. If all the earlier rights on which an opposition is based cease to exist, the opponent will be granted the opportunity to withdraw its opposition. If it does not do so, the Office will take a decision rejecting the opposition.

##### 7.3.4.3 Calculation of time limits

If the suspension is decided for a definite period of time, the Office's notification must also indicate the date when the proceedings are to be resumed, and what happens after that. When the suspension is requested by both parties because there are

ongoing negotiations, the period will always be 6 months, regardless of the period requested by the parties.

For example, if a request for a 2-month suspension signed by both parties and submitted on 15/01/2017 (5 days before the expiry of the time limit of the opponent for completing the opposition — 20/01/2017) is dealt with on 30/01/2017, the result will be that:

- the Office has suspended the opposition proceedings at the request of both parties;
- the suspension takes effect as from 15/01/2017 (the date when the suspension request was received at the Office) and will expire on 15/07/2017;
- the proceedings will be resumed on 16/07/2017 (6 months, irrespective of the period requested by the parties), with no further notification from the Office;
- the time limit for the opponent is now 15/09/2017 (two full months for the opponent to complete the file);
- the time limit for the applicant is now 15/11/2017 (two full months after the opponent's time limit).

## 7.4 Multiple oppositions

### [Article 9 EUTMDR](#)

Multiple oppositions are when different oppositions are filed against the same EUTM application.

In the case of multiple oppositions, some extra factors have to be taken into account.

Firstly, unless there is a major delay during the admissibility stage concerning one of the oppositions, the practice is to notify the applicant of the admissibility of all the oppositions at the same time. Secondly, multiple oppositions may lead to some of them being suspended for reasons of economy of proceedings. Thirdly, a restriction made by the applicant in the course of one of the proceedings may have an impact on the other oppositions. Furthermore, it may be practical to take the decisions in a certain order.

Finally, under certain circumstances, multiple oppositions may be joined and dealt with in one set of proceedings.

### 7.4.1 Multiple oppositions and restrictions

When there are multiple oppositions and the applicant restricts the goods and services in one of the opposition proceedings, all the other opponents will have to be informed by means of an appropriate letter insofar as the restriction concerns the goods or services contested by the other oppositions.

However, if there is no connection between the goods or services in the restriction and the contested goods and services, the opponent need not be informed.

For example, there are four oppositions against the same EUTM application, applied for in respect of goods in Classes 3, 14, 18 and 25. The oppositions are directed against the following classes:

Opposition	Extent
No 1	Class 3
No 2	Class 25
No 3	Classes 18 and 25
No 4	Classes 14 and 25

The applicant sends a restriction affecting opposition 2, deleting *clothing* and *headgear*. The relevant letters should be sent not only in opposition 2, but also in oppositions 3 and 4. As the restriction does not affect the contested goods of opposition 1, no action is necessary in this opposition.

#### 7.4.2 Multiple oppositions and decisions

Once an opposition reaches the decision stage, it is important to take account of any other multiple oppositions pending against the same EUTM application. Before a ruling can be given on an opposition, the stage of proceedings of the multiple oppositions must be analysed and, depending on the situation, a decision may be taken or the opposition must be suspended. The general principle to be applied is that contested goods and services should not be rejected more than once at different points in time. The three situations that may occur are described in the following.

##### 7.4.2.1 All oppositions against the same EUTM application are ready for decision at the same time

The order in which the decisions are taken is at the discretion of the examiner. However, the following has to be taken into account.

If all oppositions will fail, the decisions can be taken in any order, as the rejection of the opposition does not affect the EUTM application. Even if one of the decisions were to be appealed before the others are taken, it would seem preferable not to suspend the oppositions as the procedure before the Board of Appeal can take some time.

If several oppositions will be successful against overlapping goods and services, first the decision eliminating most goods and services of the EUTM application (the widest extent of the opposition) should be taken and the remaining oppositions suspended. Once the first decision is final, the opponents in the remaining oppositions must be consulted on whether they wish to maintain or withdraw their oppositions.

Assuming that the oppositions are maintained, the next 'widest' opposition is decided and the same process continues until all of the oppositions are dealt with.

When two oppositions are of the same extent, the general principles apply when taking the decisions.

In the example mentioned above under [paragraph 7.4.1](#), the first decision should either be taken in opposition 3 or in opposition 4. Opposition 1 has no goods and services which overlap with those of the other oppositions and can therefore be taken independently.

Suppose the first decision is taken in opposition 4, and the EUTM application is rejected for Classes 14 and 25. In this case, oppositions 2 and 3 need to be suspended.

If the appeal period has expired and no appeal is filed, opposition 2 is disposed of, as it no longer has an object. The parties should be informed and the opposition must be closed. The case is considered to have not proceeded to judgment within the meaning of [Article 109\(5\) EUTMR](#). Consequently, the costs are at the discretion of the Office. If the parties inform the Office that they agree on the costs, a decision on costs will not be taken. Generally, the decision will be that each party bears its own costs.

7.4.2.2 Only one opposition is ready for decision and the other oppositions are still in the adversarial phase of the proceedings

If the opposition is to be rejected, a decision can be taken without further impact on the pending multiple oppositions because the rejection does not have any effect on the EUTM application.

If the opposition is successful and the decision rejects the contested EUTM application in its entirety, the pending multiple oppositions must be suspended until the decision is final. Once the appeal period has expired and no appeal has been filed, the multiple oppositions are disposed of, as they no longer have an object. The parties should be informed and the opposition must be closed. The case is considered to have not proceeded to judgment within the meaning of [Article 109\(5\) EUTMR](#). Consequently, the costs are at the discretion of the Office. If the parties inform the Office that they agree on the costs, a decision on costs will not be taken. Generally, the decision will be that each party bears its own costs.

The same applies if the decision on the opposition rejects **part** of the goods and services of the contested EUTM application but **all** of the goods and services against which the multiple oppositions are directed.

However, multiple oppositions must be suspended if the decision on the opposition rejects **part** of the goods and services of the contested EUTM application but only **part** of the goods and services against which the multiple oppositions are directed. The suspension will last until the decision has become final. If this is the case, the opponents of the multiple oppositions will be invited to inform the Office whether they wish to maintain or withdraw the opposition. In the case of a withdrawal of the opposition, the proceedings are closed and both parties are informed. If the proceedings are closed after the expiry of the cooling-off period, the Office will decide, in accordance with [Article 109\(3\) EUTMR](#), that each party bears its own costs. If the



parties inform the Office before the closure of proceedings that they agree on the costs, a decision on costs will not be taken.

#### 7.4.2.3 Two or more oppositions are ready for decision and others are still in the adversarial phase of the proceedings

It may happen that some of the oppositions against an EUTM application are ready for a ruling and some are still at different stages of the adversarial phase. In this situation the principles described under 1 and 2 apply in combination. It depends on the outcome of the decisions and on the scope of the pending cases whether a decision may be taken in some oppositions and whether the multiple oppositions must be suspended.

#### 7.4.3 Joinder of proceedings

##### [Article 9\(1\) EUTMDR](#)

[Article 9\(1\) EUTMDR](#) allows the Office to deal with multiple oppositions in one set of proceedings. If it is decided to join the oppositions, the parties must be notified.

Oppositions may be joined upon the request of one of the parties if they are directed against the same EUTM application. It is more likely that the Office would join them if, in addition, they were filed by the same opponent or if there were an economic link between the opponents, for example a parent and subsidiary company. The oppositions must be at the same procedural stage.

When the Office decides to join the oppositions, it should verify whether the opponents have the same representative. If not, they must be asked to appoint one single representative. In addition, the earlier rights must be identical or very similar. If the representatives do not reply or do not want to appoint a single representative, the joinder must be undone and the oppositions dealt with separately.

If at any stage these conditions are no longer fulfilled, for example the one and only earlier right of one of the joined oppositions is transferred to a third party, the joinder may be undone.

Unless the joinder is undone before the decision is taken, only one decision is taken.

## **7.5 Change of parties (transfer, change of name, change of representative, interruption of proceedings)**

### 7.5.1 Transfer and opposition proceedings

#### 7.5.1.1 Introduction and basic principle

#### [Article 20 EUTMR](#)

A transfer or assignment of an earlier right is a change of ownership of this right. For further information see the Guidelines, [Part E, Register Operations, Section 3, EUTMs and RCDs as Objects of Property, Chapter 1, Transfer](#).

The basic principle is that the new owner substitutes the old owner in the proceedings. The Office's practice for dealing with transfers is described in paragraphs [7.5.1.2](#) (the earlier registration is an EUTM), [7.5.1.3](#) (the earlier registration is a national registration), [7.5.1.4](#) (the earlier registrations are a combination of EUTM registrations and national registrations) and [7.5.1.5](#) (transfer of a contested EUTM application during opposition proceedings).

A transfer can be made in several ways, including the simple sale of an earlier mark from A to B, a company C being bought (trade marks included) by company D, a merger of companies E and F into company G (universal succession), or legal succession (after the owner has died, the heirs become the new owners). This is not an exhaustive list.

When a transfer is made during opposition proceedings, several situations can arise. Whereas, for earlier EUTM registrations or applications on which the opposition is based, the new owner can only become party to the proceedings (or file observations) once the request for registration of the transfer has reached the Office, for earlier national registrations or applications it suffices that the new owner files evidence of the transfer.

#### 7.5.1.2 Transfer of earlier EUTM

#### [Article 20\(11\) and \(12\) EUTMR](#)

For earlier EUTMs or EUTM applications, [Article 20\(11\) EUTMR](#) provides that, as long as a transfer has not been entered in the Register, the successor in title may not invoke the rights arising from the registration of the EUTM (application). However, in the period between the date of receipt of the request for registration of the transfer and the date of registration of the transfer, the new owner may already make statements to the Office with a view to observing time limits.

#### Opposition based on one EUTM only

When an opposition is based on one earlier EUTM only and this EUTM is/has been transferred during the opposition proceedings, the new owner becomes the new opponent. The new owner will substitute the old owner.

To this end, either the old or the new owner will have to inform the Office that the EUTM on which the opposition is based has been transferred and submit a request for registration of the transfer. As mentioned above, as soon as the request is received by the Office, the new owner may already make statements. However, it only becomes party to the proceedings once the transfer is registered.

In practice, once the Office is informed that a request for registration is received, the proceedings can continue with the new owner. Nevertheless, the transfer has to be registered before a decision on the opposition is taken. If the opposition is ready for decision but the transfer has not been registered, the opposition must be suspended.

If the new owner informs the Office that it does not want to continue the proceedings, the opposition is considered withdrawn.

#### Partial transfer of the only EUTM on which the opposition is based

In cases of a partial transfer, one part of the earlier EUTM remains with the original owner and another part is transferred to a new owner. The same principles apply to partial transfers as to the transfer of only one of a number of EUTM registrations on which the opposition is based, as described in the paragraph immediately below.

#### Opposition based on more than one earlier EUTM

When an opposition is based on more than one earlier EUTM and all these marks are/ have been transferred to the same new owner during the opposition proceedings, the situation is the same as for an opposition based on a single EUTM, as described above.

The situation is, however, different when only one of the earlier EUTMs is/has been transferred. In this case, the new owner may also become an opponent, with the result that there are two opponents. The new opponents will be treated as 'joint opponents', meaning that the Office will continue dealing with the case in exactly the same way as before, that is to say, as **one** opposition, albeit with more than one opponent. Moreover, the Office will consider the original representative as the 'common' representative for both opponents and will not invite the new opponent to appoint a new representative. However, the new opponent always has the option of appointing a representative of its choice.

Common representation does not mean that opponents may not act independently, to the extent that their earlier rights remain independent: if, for instance, one of the opponents enters into a friendly settlement with the applicant, the opposition will be treated as partially withdrawn in respect of the earlier rights owned by this opponent.

If one of the joint opponents wants to withdraw, this will be accepted independently of whether the other wants to continue. Should the proceedings be continued, they will only be based on the rights of the opponent that did not withdraw. No separate decision on costs will be taken.

### 7.5.1.3 Transfer of earlier national registration

#### Opposition based on one national registration only

When an opposition is based on one earlier national registration only and this registration is/has been transferred during the opposition proceedings, the new owner also becomes the new opponent. The new owner will substitute the old owner.

To this end, either the old or the new owner will have to inform the Office that the earlier national registration on which the opposition is based has been transferred and must file evidence thereof, that is, the deed of transfer or any other evidence showing the agreement of the parties to the transfer/change of ownership.

The Office does not require the new owner to confirm that it wishes to continue the proceedings. As long as the evidence of the transfer is in order, the new owner is accepted as the new opponent. If it informs the Office of the transfer, but does not submit (sufficient) evidence thereof, the opposition proceedings have to be suspended while the new owner is given a time limit within which to submit evidence of the transfer.

As there are different national practices, it is not always obligatory to submit a copy of the request to register the transfer with the national office. Nevertheless, in those Member States where a transfer must be registered in order to have effect against third parties, the transfer must have been registered before a decision on the opposition is taken. If the opposition is ready for decision but the transfer has not been registered, the opposition must be suspended and the opponent required to submit evidence of registration of the transfer.

If the new owner does not submit the required evidence, the proceedings must be continued with the old owner. If the old owner maintains that it is not the owner any more, the opposition has become unfounded, as the opponent is no longer the owner of the earlier right. The old owner must be informed that the opposition will be rejected as such unless it withdraws the opposition.

If the new owner submits the required evidence and informs the Office that it does not want to continue the proceedings, the opposition is considered withdrawn.

#### Partial transfer of the only national registration on which the opposition is based

In cases of a partial transfer, one part of the earlier national registration remains with the original owner and another part with a new owner. The same principles apply to partial transfers as to transfers of only one of a number of national registrations on which the opposition is based, as described in the paragraph immediately below.

#### Opposition based on more than one earlier national registration

When an opposition is based on more than one earlier national registration and these are/have been transferred to the same new owner during the opposition proceedings, the situation is the same as for the transfer of a single mark upon which an opposition is based, as described above.

The situation is, however, different when only one of the earlier national rights is/has been transferred. In this case the new owner may also become an opponent, with the result that there are two opponents. The new opponents will be treated as 'joint opponents', meaning that the Office will continue dealing with the case in exactly the same way as before, that is to say, as **one** opposition, albeit with more than one opponent. Moreover, the Office will consider the original representative as the 'common' representative for both opponents and will not invite the new opponent to appoint a new representative. However, the new opponent always has the option of appointing a representative of its choice.

If one of the joint opponents wants to withdraw, this is to be accepted independently of whether the other wants to continue. Of course, if the proceedings are continued it will be based only on the rights of the opponent that did not withdraw. No separate decision on costs will be taken.

#### 7.5.1.4 Opposition based on a combination of EUTM registrations and national registrations

When an opposition is based on one or more EUTM registrations **and** one or more national registrations at the same time and one of these marks is/has been transferred to the same new owner during the opposition proceedings, the principles set out above apply *mutatis mutandis*.

In all of these situations, once the Office becomes aware of the transfer of ownership, it will update the official database to include the new opponent/both opponents and will inform the parties for information purposes only. However, the mere fact that the earlier registrations have been transferred will never justify the granting of a new time limit for submitting observations or any other documents once the original time limit has expired.

#### 7.5.1.5 Transfer of the contested EUTM application

When during opposition proceedings the contested EUTM application is/has been transferred, the opposition follows the application, that is to say, the opponent is informed of the transfer and the proceedings continue between the new owner of the EUTM application and the opponent.

#### 7.5.1.6 Partial transfer of a contested EUTM application

### [Article 14\(2\) EUTMIR](#)

When there has been a partial transfer of a (contested) EUTM application, the Office must create a separate file for the new registration (application) with a new registration (application) number.

In this case, when the transfer is recorded in the Register and a new EUTM application is created, the opposition examiner also has to create a new opposition file against the

new EUTM application, since it is not possible to deal with one opposition against two separate EUTM applications.

However, this is only the case when some of the originally contested goods and services are maintained in the 'old' EUTM application and some in the newly created EUTM application. For example: Opponent X opposes all the goods of EUTM application Y, applied for in Class 12 for *apparatus for locomotion by land and air*, and for *clothing and footwear* in Class 25. EUTM application Y is partially transferred, and split into old EUTM application Y for *apparatus for locomotion by land and clothing*, and new EUTM application Y for *apparatus for locomotion by air*, and *footwear*.

Articles [20](#) and [27](#) EUTMR

Since there was only one opposition fee to be paid when the opponent filed its opposition, a second fee for the new opposition created after the split of the EUTM application is not required because, at the time of filing, the opposition was only directed against one EUTM application.

Regarding the apportionment of costs, the opposition examiner will take into account the fact that only one opposition fee was paid.

Moreover, depending on the circumstances of the case, it could be possible to join the proceedings (e.g. when the representative of the 'old' and 'new' applications is the same).

#### 7.5.2 Parties are the same after transfer

In the event that, as a result of a transfer, the opponent and applicant become the same person or entity, the opposition becomes devoid of any purpose and will accordingly be closed *ex officio* by the Office.

#### 7.5.3 Change of names

As mentioned above, a change of name does not imply a change of ownership.

#### 7.5.4 Change of representatives

[Article 119 EUTMR](#)

When there is a change of representative during opposition proceedings, the other party will have to be informed by sending it a copy of the letter and of any authorisation submitted.

For detailed information please refer to the Guidelines, [Part A, General Rules, Section 5, Parties to the Proceedings and Professional Representation](#).

### 7.5.5 Interruption of the proceedings due to death or legal incapacity of the applicant or its representative

[Article 106 EUTMR](#)

[Article 72 EUTMDR](#)

[Article 106 EUTMR](#) deals with interruption of proceedings. Paragraph 1 distinguishes three situations:

Opposition proceedings before the Office will be interrupted:

1. when the EUTM **applicant** has died or is under legal guardianship;
2. when the EUTM applicant is subject to bankruptcy or any similar proceedings;
3. when the representative of an applicant has died or is otherwise prevented from representing the applicant. For further information see the Guidelines, [Part A, General Rules, Section 5, Parties to the Proceedings and Professional Representation](#).

[Article 106 EUTMR](#) only refers to the applicant and its representative and does not mention anything about other parties, such as opponents. In the absence of relevant provisions, the Office will apply this provision only to cases where the applicant (or its representative) is not able to continue the proceedings. Therefore, if, for example, the opponent is declared bankrupt, the proceedings will not be interrupted (even where the opponent is the applicant/proprietor of an earlier EUTM application/EUTM). The uncertainty of the legal status of an opponent or its representative will not be to the detriment of the applicant. In such a case, when the notification is returned to the Office as undeliverable, the normal rules for public notification apply.

#### 7.5.5.1 Death or legal incapacity of the applicant

In the event of the death of the applicant or of the person authorised by national law to act on their behalf because of the legal incapacity of the applicant, the proceedings are only interrupted when this is requested by the representative of the applicant/ authorised person or when the representative resigns.

#### 7.5.5.2 Applicant prevented from continuing the proceedings before the Office owing to legal reasons (e.g. bankruptcy)

[Article 106\(1\)\(b\) EUTMR](#)

[Article 72\(3\) EUTMDR](#)

[Article 106\(1\)\(b\) EUTMR](#) applies from the point in time from which the party to the proceedings is no longer entitled to dispose of the procedure, i.e. to dispose of its assets, until the point in time a liquidator or trustee is appointed who will then continue to represent the party under the law.

When the applicant is represented by a professional representative who has not resigned, there is no need to interrupt the proceedings. The Office considers the applicant's representative to be entitled to represent the applicant until the Office is informed otherwise by the representative itself, by the designated trustee or the court dealing with the legal action in question.

If the representative informs the Office that it is resigning, how the Office proceeds will depend on whether the representative also indicates who will act as trustee or liquidator in the bankruptcy.

- If the representative does indicate a trustee or liquidator, the Office will continue to correspond with that trustee or liquidator. If there were time limits affecting the applicant that had not yet expired when it went bankrupt, the Office will re-start these time limits. Therefore, in this case, the proceedings are interrupted and immediately resumed. For example, if the applicant still had ten days to file observations when it went bankrupt, the new letter of the Office to the trustee will give a fresh time limit of 2 months to file those observations.
- If the representative does not give any information regarding a liquidator or trustee, the Office has no choice but to declare an interruption of the proceedings. A communication to that effect will be sent to the bankrupt applicant directly and to the opponent. Although it is not up to the Office to investigate who the liquidator is, the Office will keep on trying to communicate with the bankrupt applicant with the aim of resuming the proceedings. This is because, although the bankrupt applicant is not allowed to undertake binding legal acts, generally it still receives correspondence, or, if not, the correspondence is delivered automatically to the trustee as long as there is one. The Office might also consider information on the identity of the trustee provided by the opponent.

When the notification is returned to the Office as undeliverable, the normal rules for public notification apply.

Evidence submitted about the appointment of the liquidator or trustee need not be translated into the language of the proceedings.

Once the Office has been informed of who the liquidator or trustee is, the proceedings are resumed from a date to be fixed by the Office. The other party must be informed. In the absence of this information, the proceedings will remain interrupted.

Time limits that had not yet expired when the proceedings were interrupted start running again when the proceedings are resumed. For example, if the proceedings were interrupted ten days before the applicant had to submit observations, a new time limit will start — of 2 months rather than the ten days left at the time of the interruption. For clarification, the letter sent by the Office informing the parties about the resumption will fix a new time limit.



### 7.5.5.3 Death or legal incapacity of the applicant's representative

[Article 106\(1\)\(c\)](#) and [Article 119\(2\) EUTMR](#)

In the case referred to in [Article 106\(1\)\(c\) EUTMR](#), the proceedings must be interrupted and will be resumed when the Office is informed of the appointment of a new representative of the EUTM applicant.

This interruption will last a maximum of 3 months and, if no representative is appointed before the end of this period, the proceedings will be resumed by the Office. When resuming the proceedings, the Office will proceed as follows.

- If the appointment of a representative is compulsory under [Article 119\(2\) EUTMR](#) because the applicant has neither its domicile nor its seat in the EEA, the Office will contact the applicant and inform it that the EUTM application will be refused if it does not appoint a representative within a specified time limit.
- If appointment of a representative is **not** compulsory under [Article 119\(2\) EUTMR](#), the Office will resume the proceedings and will send all the communications to the applicant directly.

In both cases, resuming the proceedings will mean that any time limits pending for the applicant when the proceedings were interrupted start running again once the proceedings are resumed.

## **Annex — Calculation of the grace period for non-use in the case of national marks**

The following table sets out the **national provisions** defining the date of commencement of the 5-year grace period for non-use for **national marks** (last general update on 15/09/2020). The abbreviations 'TMA' or 'IPL' have been used as a generic reference to the relevant legislative act (Trade Mark Act or IP Law). The table also provides the **headings** of the national database extracts where the relevant date can be found.

Member State	Relevant legal provisions	Relevant heading in the official database extract	Comments
Austria	Article 33a(1a) AT-TMA '5 years after <b>the end of the opposition period</b> or after <b>the final decision on opposition</b> or after <b>the closure of opposition procedure ...</b> '	The beginning of the use period (Fristbeginn für Benutzung)	
Benelux	Article 2.23bis(1) BX-TMA '... 5 years following <b>the date of completion of the registration procedure ...</b> '  Article 2.23bis(2) BX-TMA '... the 5-year period ... shall be calculated from the date when the mark can no longer be subject of a refusal on absolute grounds or an opposition or, in the event that a refusal has been issued or an opposition has been lodged, from the date when a decision lifting the Office's objections on absolute grounds or terminating the opposition proceedings became final or the opposition was withdrawn.'	<b>Regular registration proceedings:</b> Registration date (Inschrijvingsdatum / Date de l'enregistrement)  <b>Accelerated registration proceedings:</b> Status accelerated registration (Status van spoedinschrijving / Phase d'enregistrement accéléré)	In <b>accelerated registration</b> , Benelux applies a post-registration opposition procedure and, therefore, the date of completion of the registration procedure is the date appearing under a separate heading 'status accelerated registration'.
Bulgaria	Article 21(1) BG-TMA '... within a period of 5 years as from <b>the date of registration ...</b> '	Registration date (Дата на регистрация)	

Member State	Relevant legal provisions	Relevant heading in the official database extract	Comments
Croatia	<p>Article 20 HR-TMA</p> <p>‘... 5 years from <b>the date of completion of the registration procedure ...</b>’</p> <p>Article 47(1) HR-TMA</p> <p>‘... during the 5-year period preceding the date of filing the application or the date of claiming the priority right of the trade mark, the earlier trade mark has been in genuine use ..., the earlier trade mark has <b>been registered</b> for not less than 5 years.’</p>	<p>Registration Date</p> <p>(Datum priznanja) (INID code 151)</p>	
Cyprus	<p>Article 39(1)(a) CY-TMA</p> <p>‘... within a period of five consecutive years from <b>the registration ...</b>’</p> <p>Article 33(3) CY-TMA</p> <p>‘A mark ... is considered to have been registered on <b>the date of completion of the registration procedure.</b>’</p>	<p>Date of registration (Ημερομηνία Εγγραφής)</p>	<p>In <b>TMview</b>, the relevant date is <b>not</b> the ‘Registration date’ (which, according to a previous legal definition, coincided with the ‘Application date’). The relevant date can often be found in the ‘Recordals’ section, under ‘Event description: Trade mark registered on ...’.</p>

Member State	Relevant legal provisions	Relevant heading in the official database extract	Comments
Czech Republic	<p>Article 13(1) CZ-TMA  ‘... 5 years following the registration ...’</p> <p>Article 28(1), (3) CZ-TMA  ‘(1) ... The Office will register the trade mark in the Register together with stating the registration date therein ...’</p> <p>(3) The registration of the trade mark in the Register takes effect as of the registration date.’</p>	<p>Registration date (Datum zápisu)  (INID code 151)</p>	
Denmark	<p>Article 10c(1) DK-TMA  ‘... for a continuous period of 5 years from the date of completion of the registration procedure ...’</p> <p>Article 10c(2)(i) DK-TMA  ‘The registration procedure shall be deemed completed when a trade mark is registered ...’</p>	<p>Registration procedure terminated (Reg. procedure slut)</p>	<p><b>Trade marks registered as of 01/01/2019:</b>  Date of registration</p> <p><b>Trade marks registered before 01/01/2019:</b>  <b>Where no opposition has been filed:</b>  First day after the end of the opposition period.</p> <p><b>Where an opposition has been filed:</b>  (a) date when the decision terminating the opposition proceedings became final, or  (b) date of withdrawal of the opposition.</p>
Estonia	<p>Article 17(3) EE-TMA  ‘... 5 years have passed since the registration of the earlier trade mark.’</p>	<p>Registration date (Registreerimise kuupäev)</p>	

Member State	Relevant legal provisions	Relevant heading in the official database extract	Comments
Finland	<p>Article 46 FI-TMA</p> <p>‘... 5-year period shall be calculated from <b>the date on which the mark can no longer be opposed</b> ... if an opposition has been lodged, from <b>the date when a decision terminating the opposition proceedings became final</b> or the <b>opposition was withdrawn.</b>’</p>	<p><b>Trade marks filed as of, or pending completion of the registration procedure on, 01/05/2019:</b></p> <p>Date of commencement of 5-year use period (5 vuoden käyttämisaian alkamisaika)</p> <p><b>Trade marks whose registration procedure was completed before 01/05/2019:</b></p> <p>(a) <u>where no opposition was filed:</u> First day after the date under ‘Opposition end date’ (‘Väiteajan päättämispäivä’)</p> <p>(b) <u>where an opposition was filed:</u> See section ‘Applications, appeals and oppositions relating to the trade mark’ / ‘Event: Opposition’ / ‘Status: Closed’ / ‘Status date’ (‘Tavaramerkkiin liittyvät hakemukset, valitukset, väitteet’ / Tapahtuma’: ‘Väite’ / ‘Tila’: Loppuunkäsittely’ / Tapahtumapäivä)</p>	
France	<p>Article R 712-23 FR-IPL</p> <p>‘The date on which a mark is deemed to be registered, in particular for the purposes of applying Articles ... L. 714-5, is, for French marks, <b>the date of the ‘Bulletin officiel de la propriété industrielle’ in which the registration has been published.</b>’</p>	<p>History / Registration without modification (Historique / Enregistrement sans modification)</p>	

Member State	Relevant legal provisions	Relevant heading in the official database extract	Comments
Germany	<p>Article 26(5) DE-TMA</p> <p><b>Where no opposition has been filed:</b></p> <p>‘... 5 years from the date when the mark can no longer be opposed.’</p> <p><b>Where opposition has been filed:</b></p> <p>‘... 5 years from the date when the decision terminating the opposition proceedings became final or the opposition was withdrawn.’</p>	<p><b>Trade marks filed as of 14/01/2019:</b></p> <p>Start of grace period for use (Beginn der Benutzungsschonfrist)</p> <p><b>Trade marks filed before 14/01/2019:</b></p> <p>(a) <u>where no opposition against the earlier mark was filed and the <b>opposition against the EUTM based on that earlier mark was filed before 14/01/2019:</b></u></p> <p>Date of entry into register (Tag der Eintragung im Register) (INID code 151)</p> <p>(b) <u>where no opposition against the earlier mark was filed and the <b>opposition against the EUTM based on that earlier mark was filed on or after 14/01/2019:</b></u></p> <p>First day after the date of the ‘End of opposition period’ (EWT) (‘Ablauf der Widerspruchsfrist’)</p> <p>(c) <u>where an opposition against the earlier mark was filed:</u></p> <p>‘Date of conclusion’ (‘Abschlussdatum’) in details for the section ‘Opposition proceedings’* (‘Widerspruchsverfahren’)</p>	<p>* See section ‘Kind of procedure’ / ‘Opposition proceedings’ – ‘Display details’ (‘Verfahrensart’ / ‘Widerspruchsverfahren’ – ‘Details anzeigen’) (line with the entry related to the closure of the opposition proceedings, e.g. ‘Opposition proceedings’ – ‘Trade mark cancelled in part’ (‘Widerspruchsverfahren’ – ‘Marke teilweise gelöscht’)) / ‘Date of conclusion’ (‘Datum des Abschlusses’)</p> <p>Article 158 DE-TMA</p> <p>Transitional provisions</p> <p>‘...’</p> <p>(5) If use of a trade mark on which an opposition is based is contested in opposition proceedings lodged prior to 14/01/2019, Article 26 and Article 43(1) in the version in force until 13/01/2019 shall apply.’</p> <p>Article 26(5) DE-TMA (in the version in force until 13/01/2019):</p> <p>‘Insofar as use within 5 years from the point in time of the registration is necessary, in cases in which an opposition has been lodged against the registration, the time of the registration shall be substituted by the point in time of the conclusion of the opposition proceedings.’</p>

Member State	Relevant legal provisions	Relevant heading in the official database extract	Comments
Greece	<p>Article 28(1) GR-TMA:            ‘... provided that the earlier trade mark <b>has been registered</b> for at least 5 years ...’</p>	N/A	No official public online trade mark database exists in Greece. Official information on trade marks protected in Greece is accessible online only through TMview. The relevant information may be found in TMview under the heading ‘Registration date’.
Hungary	<p>Article 18(1) HU-TMA            ‘... within a period of 5 years following <b>the date of registration</b> ...’</p> <p>Article 64(1) HU-TMA            ‘ <b>The date of the decision on registration</b> shall be the date of registration of the trade mark.’</p> <p>Article 18(2) HU-TMA            ‘... in the case of a trade mark registered in ‘special expedited procedure’ [Article 64/A(7)], the date of registration shall be the date:</p> <p>a) following <b>the expiry of the</b> period pursuant to Article 61/B(1) [<b>3-month opposition period</b>]; or</p> <p>b) in the case of an opposition, when <b>the decision on the opposition becomes final.</b>’</p>	Starting date of the 5-year period within which the trade mark must be put to use (Védjegyhasználat megkezdésére nyitva álló ötéves időszak kezdő időpontja)	

Member State	Relevant legal provisions	Relevant heading in the official database extract	Comments
Ireland	<p>Article 16A(1) IE-TMA  ‘... within the period of 5 years following <b>the date of completion of the registration procedure</b> ...’</p> <p>Article 45(5) IE-TMA  ‘The registration procedure shall be regarded as completed <b>on the date of publication</b> under subsection (4); and that date shall be entered in the register.’</p>	Date of publication of registration	The relevant date can be found in TMview under the headings ‘Publication’ / ‘Publication section: Registration’ / ‘Publication date’ (i.e. <u>not</u> under ‘Registration date’).
Italy	<p>Article 24(1) IT-IPL  ‘... within 5 years from <b>the registration</b>.’</p>	Registration date (Data registrazione)	The relevant date of registration is that of the <b>original</b> registration of the mark.
Latvia	<p>Article 26 LV-TMA  ‘(1) ... within 5 years from the completion of the registration procedure ...’</p> <p>(2) The period of 5 years ... shall run <b>from the date on which the opposition to the trade mark in question is no longer available or, if an opposition has been received, of the decision closing the opposition proceedings or withdrawn</b>.’</p>	<p><b>Trade marks filed as of 06/03/2020 and those filed before that date and registered as of 20/09/2020:</b></p> <p>First day after the date under ‘Registration finish date’ (Reģ. procedūras pabeigšanas datums) (INID code 451)</p> <p><b>Trade marks filed before 06/03/2020 and registered before 20/09/2020:</b></p> <p>Registration date (Reģistrācijas datums) (INID code 151)</p>	
Lithuania	<p>Article 20 LT-TMA  ‘... within a period of 5 years following <b>registration</b> ...’</p>	Registration date (Registrācijas data) (INID code 151)	



Member State	Relevant legal provisions	Relevant heading in the official database extract	Comments
Malta	<p>Article 26(1) MT-TMA  ‘... within a period of 5 years following <b>the date of completion of the registration procedure ...</b>’</p> <p>Article 56(4) MT-TMA  ‘On the registration of a trademark the Comptroller shall publish the registration in the prescribed manner and issue to the applicant a certificate of registration.’</p>	<p>Registration date (Data tar-Registrazzjoni)  (INID code 151)</p>	
Poland	<p>Article 169(1)(i) PL-IPL  ‘... for a period of five consecutive years after <b>the decision on the grant of a right of protection has been taken ...</b>’</p>	<p>Date of grant (Data udzielenia prawa)</p>	
Portugal	<p>Article 268(1) PT-IPL  ‘... the registration shall lapse if the trade mark is not put to genuine use over a period of five consecutive years.’</p> <p>Article 268(5) PT-IPL  ‘The 5-year period starts running as from <b>the date of registration.</b>’</p>	<p>Date of the decision (Data do Despacho)</p>	

Member State	Relevant legal provisions	Relevant heading in the official database extract	Comments
Romania	<p>Article 55(1)(a) RO-TMA</p> <p>'... within a continuous 5-year period calculated from <b>the date of completion of the registration procedure ...</b>'</p> <p>Article 32 RO-TMA</p> <p>'(1) OSIM shall enter in the trade marks register those marks admitted for registration for which the registration procedure has been completed ... The date of completion of the registration procedure shall be entered in the register.</p> <p>(2) The procedure for registration of a trade mark shall be deemed to be completed <b>on the date on which the trade mark application admitted to registration may no longer be the subject of an opposition or, in the case where an opposition has been filed, on the date on which the opposition decision became final or opposition has been withdrawn.</b>'</p>	<p><b>For marks filed as of 13/07/2020:</b></p> <p>Date of completion of the registration procedure (Data inchidere procedura)</p> <p><b>For marks filed before 13/07/2020:</b></p> <p>Granting date (Data acordare)</p>	<p>The implementation of the new heading 'Date of completion of the registration procedure' still pending at the time of the last general update of this table.</p>
Slovakia	<p>Article 7c(1) SK-TMA</p> <p>'... <i>within a period of 5 years from <b>the date of registration of the trade mark...</b></i>'</p>	<p>Registration date (Dátum zápisu)</p> <p>(INID code 151)</p>	

<b>Member State</b>	<b>Relevant legal provisions</b>	<b>Relevant heading in the official database extract</b>	<b>Comments</b>
<b>Slovenia</b>	Article 52.b(1) SI-IPL '... within 5 years from <b>the date of entry of the mark in the register ...</b> '	Registration date (Datum registracije) (INID code 151)	

Member State	Relevant legal provisions	Relevant heading in the official database extract	Comments
Spain	<p>Article 39(1) ES-TMA  ‘... within a period of 5 years from <b>the date of registration ...</b>’</p> <p>Article 39(2) ES-TMA  ‘The 5-year date referred to in the previous paragraph shall begin on <b>the day on which the registration of the trade mark becomes final</b>. This date shall be entered in the Register of Marks.’</p>	<p><b>If the opposition against the EUTM application was filed on or after 14/01/2019:</b></p> <p>(a) <u>Where <b>no appeal</b> against the first instance decision concerning the registration of the earlier mark was filed:</u></p> <p><b>1 month after</b> the date indicated in the <b>left-column</b> ‘Date’ (‘Fecha’) in section ‘Acts of processing’ (‘Actos de tramitación’) / ‘Act performed’ (‘Acto de tramitación’) / ‘PUBLIC. CONCESION DE F. RESOL. [DATE]’.</p> <p>(b) <u>Where an <b>appeal</b> was filed against the first instance decision concerning the registration of the earlier mark, as a result of which the mark is granted:</u></p> <p>2 months after the date indicated in the <b>left-column</b> ‘Date’ (‘Fecha’) in section ‘Acts of processing’ (‘Actos de tramitación’) / ‘Act performed’ (‘Acto de tramitación’) / ‘PUBL. ESTIMAC. RECURSO DE FECHA [DATE]’ or ‘PUBL. DESESTIM. RECURSO DE FECHA [DATE]’ or ‘PUBL. INADMIS. RECURSO DE FECHA [DATE]’.</p> <p>(c) <u>Where an <b>appeal</b> was filed before the Court against the second instance decision of the Spanish national office (OEPM) concerning the registration of the earlier mark, as a result of which the mark is granted:</u></p> <p>Unless the opponent proves a later date, <b>30 business days after</b> the date indicated in section ‘Acts of processing’ (‘Actos de tramitación’), in the <b>right-column</b> ‘Act performed’ (‘Acto de tramitación’) / ‘PUBL. CONCE. RESPON. FECHA [DATE]’.</p>	<p>Further scenarios are possible. The respective party may claim and prove a different relevant date, provided that it affects the obligation to prove genuine use.</p>
FINAL			<p>Page 861</p> <p>31/03/2023</p>

Member State	Relevant legal provisions	Relevant heading in the official database extract	Comments
Sweden	Chapter 3, Article 2 SE-TMA ‘... within a period of 5 years following <b>the date of the completion of the registration procedure.</b> ’	Legal effect date (Dag för laga kraft)	<p><b>Where no opposition has been filed:</b></p> <p>First day after the 3-month opposition period lapsed (the information on the lapse of the opposition period may be found in TMview under the heading ‘Opposition period end date’).</p> <p><b>Where an opposition has been filed:</b></p> <p>The date when the decision on the opposition has become final.</p>

***GUIDELINES FOR EXAMINATION OF  
EUROPEAN UNION TRADE MARKS***

***EUROPEAN UNION  
INTELLECTUAL PROPERTY OFFICE  
(EUIPO)***

***Part C***

***Opposition***

***Section 2***

***Double identity and likelihood of confusion***

## Table of Contents

<b>Chapter 1 General principles.....</b>	<b>865</b>
<b>Chapter 2 Comparison of goods and services.....</b>	<b>879</b>
<b>Chapter 3 Relevant public and degree of attention.....</b>	<b>944</b>
<b>Chapter 4 Comparison of signs.....</b>	<b>955</b>
<b>Chapter 5 Distinctiveness of the earlier mark.....</b>	<b>1100</b>
<b>Chapter 6 Other factors.....</b>	<b>1115</b>
<b>Chapter 7 Global assessment.....</b>	<b>1128</b>

***GUIDELINES FOR EXAMINATION OF  
EUROPEAN UNION TRADE MARKS***

***EUROPEAN UNION  
INTELLECTUAL PROPERTY OFFICE  
(EUIPO)***

***Part C***

***Opposition***

***Section 2***

***Double identity and likelihood of confusion***

***Chapter 1***

***General principles***



## Table of Contents

<b>1 Introduction.....</b>	<b>867</b>
<b>2 Article 8(1) EUTMR.....</b>	<b>868</b>
2.1 Article 8(1)(a) EUTMR — double identity.....	868
2.2 Article 8(1)(b) EUTMR — likelihood of confusion.....	868
2.3 Interrelation of Article 8(1)(a) and (b) EUTMR.....	869
<b>3 The Notion of Likelihood of Confusion.....</b>	<b>869</b>
3.1 Introduction.....	869
3.2 Likelihood of confusion and likelihood of association.....	870
3.3 Likelihood of confusion and distinctiveness of the earlier mark.....	871
3.4 Likelihood of confusion: questions of fact and questions of law.....	872
3.4.1 Fact and law — similarity of goods/services and of signs.....	872
3.4.2 Fact and law — evidence.....	873
<b>4 Evaluation of the Relevant Factors for Establishing a Likelihood of Confusion.....</b>	<b>874</b>
4.1 Relevant point in time.....	874
4.2 List of factors for assessing the likelihood of confusion.....	874
<b>Annex.....</b>	<b>875</b>

## 1 Introduction

This chapter provides an introduction to and overview of the concepts of (i) double identity and (ii) likelihood of confusion that are applied in situations of conflict between trade marks in opposition proceedings under [Article 8\(1\) EUTMR](#).

The paragraphs below set out the nature of these concepts and their legal underpinning as determined by the relevant laws and as interpreted by the Court of Justice of the European Union (the ‘Court’)<sup>(44)</sup>.

The legal concepts of double identity and likelihood of confusion are used to protect trade marks and, at the same time, to define their scope of protection. It is thus important to bear in mind what aspects or functions of trade marks merit protection. Trade marks have various functions. The most fundamental one is to act as ‘indicators of origin’ of the commercial provenance of goods/services. This is their ‘essential function’. In the *Canon* judgment the Court held that:

... according to the settled case-law of the Court, the **essential function of the trade mark is to guarantee the identity of the origin of the marked product** to the consumer or end user by enabling him, without any possibility of confusion, to distinguish the product or service from others that have another origin (emphasis added).

(29/09/1998, [C-39/97](#), *Canon*, EU:C:1998:442, § 28).

The essential function of trade marks as indicating origin has been emphasised repeatedly and has become a precept of European Union trade mark law (18/06/2002, [C-299/99](#), *Remington*, EU:C:2002:377, § 30; 06/10/2005, [C-120/04](#), *Thomson Life*, EU:C:2005:594, § 23).

Whilst indicating origin is the essential function of trade marks, it is not the only one. Indeed, the term, ‘essential function’ implies other functions. The Court alluded to the other functions of trade marks several times (16/11/2004, [C-245/02](#), *Budweiser*, EU:C:2004:717, § 59; 25/01/2007, [C-48/05](#), *Opel*, EU:C:2007:55, § 21) but addressed them directly in the *L’Oréal* judgment, where it stated that the functions of trade marks include:

... **not only the essential function** of the trade mark, which is to guarantee to consumers the origin of the goods or services, **but also its other functions, in particular that of guaranteeing the quality of the goods or services in question and those of communication, investment or advertising** (emphasis added).

(18/06/2009, [C-487/07](#), *L’Oréal*, EU:C:2009:378, § 58-59; 23/03/2010, [C-236/08](#) – [C-238/08](#), *Google-Louis Vuitton*, EU:C:2010:159).

In examining the concepts of double identity and likelihood of confusion, this chapter touches upon several themes that are explained comprehensively in the chapters of

---

<sup>44</sup> The Court was, in fact, often interpreting Articles 4 and 5 of [Directive 2008/95/EC of the European Parliament and of the Council](#) of 22 October 2008 to approximate the laws of the Member States relating to trade marks, which for the purposes of interpretation are broadly comparable to Articles 8 and 9 EUTMR.

the Guidelines that follow. A summary of the key cases from the Court dealing with the core principles and concepts of likelihood of confusion is added in the Annex.

## 2 Article 8(1) EUTMR

[Article 8 EUTMR](#) enables the proprietor of an **earlier right** to oppose the registration of later EUTM applications in a range of situations. The present chapter will concentrate on the interpretation of double identity and likelihood of confusion within the meaning of [Article 8\(1\) EUTMR](#).

An opposition pursuant to [Article 8\(1\) EUTMR](#) can be based on earlier trade mark registrations or applications ([Article 8\(2\)\(a\) and \(b\) EUTMR](#)) and earlier well-known marks ([Article 8\(2\)\(c\) EUTMR](#)) <sup>(45)</sup>.

### 2.1 Article 8(1)(a) EUTMR — double identity

[Article 8\(1\)\(a\) EUTMR](#) provides for oppositions based on identity. It provides that, upon opposition by the proprietor of an earlier trade mark within the meaning of [Article 8\(2\) EUTMR](#), an EUTM application will not be registered ‘if it is identical with the earlier trade mark and the goods or services for which registration is applied for are identical with the goods or services for which the earlier trade mark is protected.’

The wording of [Article 8\(1\)\(a\) EUTMR](#) clearly requires identity between **both** the signs concerned **and** the goods/services in question. This situation is referred to as ‘double identity’. Whether there is double identity is a **legal finding** to be established from a direct comparison of the two conflicting signs and the goods/services in question <sup>(46)</sup>. Where double identity is established, the opponent is not required to demonstrate a likelihood of confusion in order to prevail; the protection conferred by [Article 8\(1\)\(a\) EUTMR](#) is absolute. Consequently, where there is double identity, there is no need to carry out an evaluation of the likelihood of confusion, and the opposition will automatically be upheld.

### 2.2 Article 8(1)(b) EUTMR — likelihood of confusion

[Article 8\(1\)\(b\) EUTMR](#) states that, upon opposition, an EUTM application will not be registered:

... if, because of its identity with, or similarity to, the earlier trade mark and the identity or similarity of the goods or services covered by the trade marks **there exists a likelihood of confusion** on the part of the public in the territory in which the earlier

---

<sup>45</sup> Further guidance on earlier well-known trade marks is found in the Guidelines, [Part C, Opposition, Section 5, Trade Marks with Reputation \(Article 8\(5\) EUTMR\)](#).

<sup>46</sup> Comprehensive guidance on the criteria to find identity between goods and services and between signs can be found in the respective paragraphs of the Guidelines, [Part C, Opposition, Section 2, Double Identity and Likelihood of Confusion, Chapter 2, Comparison of Goods and Services](#), and [Chapter 4, Comparison of Signs](#).

trade mark is protected; the **likelihood of confusion includes the likelihood of association** with the earlier trade mark (emphasis added).

Hence, in contrast to situations of double identity as seen above, in cases of mere similarity between the signs and the goods/services, or identity of only one of these two factors, an earlier trade mark may successfully oppose an EUTM application under [Article 8\(1\)\(b\) EUTMR](#) **only if** there is a likelihood of confusion.

## 2.3 Interrelation of Article 8(1)(a) and (b) EUTMR

Although the specific conditions under [Article 8\(1\)\(a\) and \(b\) EUTMR](#) differ, they are related. Consequently, in oppositions dealing with [Article 8\(1\) EUTMR](#), if [Article 8\(1\)\(a\) EUTMR](#) is the only ground claimed but identity between the signs and/or the goods/services cannot be established, the Office will still examine the case under [Article 8\(1\)\(b\) EUTMR](#), which requires at least similarity between signs and goods/services and a likelihood of confusion. Similarity covers situations where both marks and goods/services are similar and also situations where the marks are identical and the goods/services are similar or vice versa.

Likewise, an opposition based only on [Article 8\(1\)\(b\) EUTMR](#) that meets the requirements of [Article 8\(1\)\(a\) EUTMR](#) will be dealt with under the latter provision without any examination under [Article 8\(1\)\(b\) EUTMR](#).

## 3 The Notion of Likelihood of Confusion

### 3.1 Introduction

The assessment of the likelihood of confusion is a calculus applied in situations of conflict between trade marks in proceedings before the Office, the General Court and the Court of Justice as well as in infringement proceedings before the courts of the Member States. However, neither the EUTMR nor [Directive 2015/2436](#) <sup>(47)</sup> contains a definition of likelihood of confusion or a statement as to precisely what ‘confusion’ refers to.

As shown below, it has been settled case-law for some time now that, fundamentally, the concept of likelihood of confusion refers to situations where:

1. the public directly confuses the conflicting trade marks, that is to say, mistakes one for the other;
2. the public makes a connection between the conflicting trade marks and assumes that the goods/services in question are from the same or economically linked undertakings (likelihood of association).

---

<sup>47</sup> [Directive \(EU\) 2015/2436](#) of the European Parliament and of the Council of 16 December 2015 to approximate the laws of the Member States relating to trade marks.

These two situations are further discussed below (see [paragraph 3.2 below](#)). The mere fact that the perception of a later trade mark brings to mind an earlier trade mark does not constitute a likelihood of confusion.

The Court has also established the principle that ‘marks with a highly distinctive character enjoy broader protection than marks with a less distinctive character’ (see [paragraph 3.3 below](#)).

Finally, the concept of likelihood of confusion as developed by the Court must be regarded as a legal concept rather than purely an empirical or factual assessment despite the fact that its analysis requires taking into account certain aspects of consumer cognitive behaviour and purchasing habits (see [paragraph 3.4 below](#)).

## 3.2 Likelihood of confusion and likelihood of association

The Court considered likelihood of confusion comprehensively in *Sabèl* (11/11/1997, [C-251/95](#), *Sabèl*, EU:C:1997:528). The Directives’ equivalents<sup>(48)</sup> of [Article 8\(1\)\(b\) EUTMR](#) and the recitals of the EUTMR clearly indicated that likelihood of confusion relates to confusion about the origin of goods/services, but the Court was required to consider what precisely this meant because there were opposing views on the meaning of, and the relationship between, ‘likelihood of confusion’ and ‘likelihood of association’, both of which are referred to in [Article 8\(1\)\(b\) EUTMR](#).

This issue needed to be resolved because it was argued that likelihood of association was broader than likelihood of confusion as it could cover instances where a later trade mark brought an earlier trade mark to mind but the consumer did not consider that the goods/services had the same commercial origin<sup>(49)</sup>. Ultimately, the issue in *Sabèl* was whether the wording ‘the likelihood of confusion includes the likelihood of association’ meant that ‘likelihood of confusion’ could cover a situation of association between trade marks that did not give rise to confusion as to origin.

The Court found that likelihood of association **is not an alternative** to likelihood of confusion, but that it merely serves to define its scope. Therefore, a finding of likelihood of confusion requires that there be confusion as to origin.

In *Canon* (paras 29-30), the Court clarified the scope of confusion as to origin when it held that:

... the risk that the public might believe that the goods and services in question come from the **same undertaking or, as the case may be, from economically linked undertakings**, constitutes a likelihood of confusion ... there can be no such likelihood where it does not appear that the public could believe that the goods or services come from the same undertaking or, as the case may be, from economically linked undertakings (emphasis added).

As seen above, likelihood of confusion relates to confusion as to commercial origin including economically linked undertakings. What matters is that the public believes

---

<sup>48</sup> Articles 4 and 5 of [Directive 2008/95/EC](#) and Articles 5 and 10 of [Directive 2015/2436](#).

<sup>49</sup> The concept came from Benelux case-law and applied, inter alia, to non-reputed marks.

that the **control** of the goods or services in question is in the hands of a single undertaking. The Court has not interpreted **economically linked undertakings** in the context of likelihood of confusion, but it has done so with respect to the free movement of goods/services. In *Ideal Standard* the Court held:

... A number of situations are covered: products put into circulation by the same undertaking, by a licensee, by a parent company, by a subsidiary of the same group, or by an exclusive distributor.

... In all the cases mentioned, control [is] in the hands of a single body: the group of companies in the case of products put into circulation by a subsidiary; the manufacturer in the case of products marketed by the distributor; the licensor in the case of products marketed by a licensee. In the case of a licence, the licensor can control the quality of the licensee's products by including in the contract clauses requiring the licensee to comply with his instructions and giving him the possibility of verifying such compliance. The origin that the trade mark is intended to guarantee is the same: it is not defined by reference to the manufacturer but by reference to the point of control of manufacture.

(22/06/1994, [C-9/93](#), *Ideal Standard*, EU:C:1994:261, § 34, 37).

Consequently, economic links will be presumed where the consumer assumes that the respective goods or services are marketed under the control of the trade mark proprietor. Such control can be assumed to exist in the case of enterprises belonging to the same group of companies and in the case of licensing, merchandising or distribution arrangements as well as in any other situation where the consumer assumes that the use of the trade mark is normally possible only with the agreement of the trade mark proprietor.

Therefore, the likelihood of confusion covers situations where:

1. the consumer directly confuses the trade marks themselves; or where
2. the consumer makes a connection between the conflicting signs and assumes that the goods/services covered are from the same or economically linked undertakings.

Hence, if the perception of a later trade mark merely brings to mind an earlier trade mark, but the consumer does not assume the same commercial origin, then this link does not constitute a likelihood of confusion despite the existence of a similarity between the signs <sup>(50)</sup>.

### **3.3 Likelihood of confusion and distinctiveness of the earlier mark**

The distinctiveness of the earlier trade mark has been held by the Court to be an important consideration when assessing the likelihood of confusion, since:

- the more distinctive the earlier trade mark, the greater will be the likelihood of confusion (11/11/1997, [C-251/95](#), *Sabèl*, EU:C:1997:528, § 24);

---

<sup>50</sup> Although such a situation could take unfair advantage of, or be detrimental to, the distinctive character or the reputation of an earlier mark under [Article 8\(5\) EUTMR](#), see the Guidelines [Part C, Opposition, Section 5, Trade Marks with Reputation \(Article 8\(5\) EUTMR\)](#).

- trade marks with a highly distinctive character enjoy broader protection than trade marks with a less distinctive character (29/09/1998, [C-39/97](#), Canon, EU:C:1998:442, § 18);
- however, the scope of protection of trade marks with low distinctive character will be narrower.

One consequence of these findings is that the enhanced distinctiveness of the earlier mark may be a decisive factor towards establishing a likelihood of confusion when the similarity between the signs and/or the goods and services is low (11/11/1997, [C-251/95](#), Sabèl, EU:C:1997:528, § 22). When the distinctiveness of the earlier trade mark is low, this may be a factor weighing against the likelihood of confusion.

### 3.4 Likelihood of confusion: questions of fact and questions of law

The concept of likelihood of confusion is a legal concept rather than a mere factual evaluation of the rational judgments and emotional preferences that inform the consumer's cognitive behaviour and purchasing habits. Therefore, assessment of the likelihood of confusion depends on both legal questions **and** facts.

#### 3.4.1 Fact and law — similarity of goods/services and of signs

Determining the relevant factors for establishing a likelihood of confusion and whether they exist is a question of law, that is to say, these factors are established by the relevant legislation, namely, the EUTMR and case-law.

For instance, [Article 8\(1\) EUTMR](#) establishes that the identity/similarity of goods/services is a condition for a likelihood of confusion. The identification of the relevant factors for evaluating whether this condition is met is also a question of law.

The Court has identified the following factors for determining whether goods/services are similar:

- their nature,
- their intended purpose,
- their method of use,
- whether they are complementary or not,
- whether they are in competition or interchangeable,
- their distribution channels/points of sale,
- their relevant public,
- their usual origin.

(29/09/1998, [C-39/97](#), Canon, EU:C:1998:442).

All these factors are legal concepts and determining the criteria to evaluate them is also a **question of law**. However, it is a **question of fact** whether, and to what degree, the legal criteria for determining, for instance, 'nature', are fulfilled in a particular case.



By way of example, *cooking fat* does not have the same nature as *petroleum lubricating oils and greases* even though both contain a fat base. *Cooking fat* is used in preparing food for human consumption, whereas *oils and greases* are used for lubricating machines. Considering ‘nature’ to be a relevant factor in the analysis of similarity of goods/services is a matter of **law**. However, it is a matter of **fact** to state that cooking fat is used in preparing food for human consumption and that oils and greases are used for machines.

Similarly, when it comes to the comparison of signs, [Article 8\(1\) EUTMR](#) establishes that the identity/similarity of signs is a condition for a likelihood of confusion. It is a **question of law** that a conceptual coincidence between signs may render them similar for the purposes of the EUTMR, but it is a **question of fact**, for instance, that the word ‘fghryz’ does not have any meaning for the Spanish public.

### 3.4.2 Fact and law — evidence

In opposition proceedings, the parties must allege and, where necessary, prove the facts in support of their arguments. This follows from [Article 95\(1\) EUTMR](#), according to which, in opposition proceedings, the Office is restricted in its examination to the facts, evidence and arguments provided by the parties and the relief sought.

Therefore, it is up to the opponent to state the facts on which the claim of similarity is based and to submit supporting evidence. For instance, where *wear-resistant cast iron* is to be compared with *medical implants*, it is not up to the Office to answer the question of whether *wear-resistant cast iron* is actually used for *medical implants*. This must be demonstrated by the opponent as it seems improbable (14/05/2002, [R 684/2000-4](#), Tinnox / TINOX).

An admission by the applicant of legal concepts is irrelevant. It does not discharge the Office from analysing and deciding on these concepts. This is not contrary to [Article 95\(1\) EUTMR](#), which is binding on the Office **only** as regards the facts, evidence and arguments and does not extend to the legal evaluation of the same. Therefore, the parties may agree as to which facts have been proven or not, but they may not determine whether or not these facts are sufficient to establish the respective legal concepts, such as similarity of goods/services, similarity of the signs, and likelihood of confusion.

[Article 95\(1\) EUTMR](#) does not prevent the Office from taking into consideration, on its own initiative, facts that are already notorious or well known or that may be learnt from generally accessible sources, for example, that PICASSO will be recognised by EU consumers as a famous Spanish painter (22/06/2004, [T-185/02](#), Picaro, EU:T:2004:189; 12/01/2006, [C-361/04 P](#), Picaro, EU:C:2006:25). However, the Office cannot quote *ex officio* new facts or arguments (e.g. reputation or degree of knowledge of the earlier mark).

Moreover, even though certain trade marks are sometimes used in daily life as generic terms for the goods and services that they cover, this should never be taken as fact by the Office. In other words, trade marks should never be referred to (or interpreted) as if they were a generic term or a category of goods or services. For instance, the fact that



in daily life part of the public refers to 'X' when talking about *yoghurts* ('X' being a trade mark for *yoghurts*) should not lead to using 'X' as a generic term for *yoghurts*.

## **4 Evaluation of the Relevant Factors for Establishing a Likelihood of Confusion**

### **4.1 Relevant point in time**

The relevant point in time for assessing the likelihood of confusion is the date the opposition decision is taken.

Where the opponent relies on **enhanced distinctiveness** of an earlier trade mark, the conditions for this must have been met on or before the filing date of the EUTM application (or any priority date) and must still be fulfilled at the point in time the decision is taken. Office practice is to assume that this is the case, unless there are indications to the contrary.

Where the EUTM applicant relies on a reduced scope of protection (weakness) of the earlier trade mark, only the date of the decision is relevant.

### **4.2 List of factors for assessing the likelihood of confusion**

The likelihood of confusion is assessed in the following steps, taking into account multiple factors:

- comparison of goods and services;
- relevant public and degree of attention;
- comparison of signs;
- distinctiveness of the earlier mark;
- any other factors;
- global assessment of the likelihood of confusion.

A separate chapter of the Guidelines is dedicated to each of the above factors and its specifics.

## Annex

General principles coming from case-law (these are not direct citations).

**11/11/1997, [C-251/95](#), Sabèl, EU:C:1997:528**

- The likelihood of confusion must be appreciated globally, taking into account all factors relevant to the circumstances of the case (para. 22).
- The appreciation of the likelihood of confusion depends on numerous elements and, in particular, on the recognition of the trade mark on the market, on the association that the public might make between the two marks and on the degree of similarity between the signs and the goods (para. 22).
- The global appreciation of the visual, aural or conceptual similarity of the marks in question must be based on the overall impression given by the marks, bearing in mind their distinctive and dominant components (para. 23).
- The average consumer normally perceives a mark as a whole and does not proceed to analyse its various details (para. 23).
- The more distinctive the earlier mark, the greater will be the likelihood of confusion (para. 24).
- It is not impossible that the conceptual similarity resulting from the fact that two marks use images with analogous semantic content may give rise to a likelihood of confusion where the earlier mark has a particularly distinctive character (para. 24).
- However, where the earlier mark is not especially well known to the public and consists of an image with little imaginative content, the mere fact that the two marks are conceptually similar is not sufficient to give rise to a likelihood of confusion (para. 25).
- The concept of likelihood of association is not an alternative to likelihood of confusion, but serves to define its scope (para. 18).
- The mere association that the public might make between two marks as a result of their analogous semantic content is not in itself a sufficient ground for concluding that there is a likelihood of confusion (para. 26).

**29/09/1998, [C-39/97](#), Canon, EU:C:1998:442**

- The risk that the public might believe that the goods or services in question come from the same undertaking or, as the case may be, from economically linked undertakings, constitutes a likelihood of confusion (para. 29).
- By contrast, there can be no such likelihood where the public does not think that the goods come from the same undertaking (or from economically linked undertakings) (para. 30).
- In assessing the similarity of the goods and services, all the relevant factors relating to those goods or services themselves should be taken into account (para. 23).
- Those factors include, inter alia, their nature, the purpose for which they are used (the translation 'end users' in the official English language version is not correct) and their method of use, and whether they are in competition with each other or are complementary (para. 23).
- A global assessment of the likelihood of confusion implies some interdependence between the relevant factors and in particular a similarity between the marks and between these goods or services. A lesser degree of similarity between the goods may be offset by a greater degree of similarities between the marks and vice versa (para. 17).
- Marks with a highly distinctive character, either per se or because of the reputation they possess on the market, enjoy broader protection than marks with a less distinctive character (para. 18).
- Registration of a trade mark may have to be refused, despite a lesser degree of similarity between the goods or services covered, where the marks are very similar and the earlier mark, in particular its reputation, is highly distinctive (para. 19).
- The distinctive character of the earlier mark and in particular its reputation must be taken into account when determining whether the similarity between the goods and services is enough to give rise to the likelihood of confusion (para. 24).
- There may be a likelihood of confusion, even if the public thinks that these goods have different places of production (para. 30).

22/06/1999, [C-342/97](#), Lloyd Schuhfabrik, EU:C:1999:323

- The level of attention of the average consumer, who is deemed to be reasonably well informed and reasonably observant and circumspect, varies according to the category of the goods and services in question (para. 26).
- However, account should be taken of the fact that average consumers rarely have the chance to make a direct comparison between different marks and must trust in their imperfect recollection of them (para. 26).
- When evaluating the importance attached to the degree of visual, aural and conceptual similarity between the signs, it is appropriate to take into account the category of goods or services in question and the way they are marketed (para. 27).
- It is possible that mere aural similarity could lead to a likelihood of confusion (para. 28).
- In determining the distinctive character of a mark and, accordingly, in assessing whether it is highly distinctive, an overall assessment needs to be made of the greater or lesser capacity of the mark to identify the goods and services for which it has been registered as coming from a particular undertaking (para. 22).
- In making that assessment, account should be taken, in particular, of the inherent characteristics of the mark, including the fact that it does or does not contain an element descriptive of the goods or services for which it has been registered; the market share held by the mark; how intensive, geographically widespread and long-standing use of the mark has been; the amount invested by the undertaking in promoting the mark; the proportion of the relevant section of the public who, because of the mark, identifies the goods and services as originating from a particular undertaking; and statements from chambers of commerce and industry or other trade and professional associations (para. 23).
- It is not possible to state in general terms, for example by referring to given percentages relating to the degree of recognition attained by the mark within the relevant section of the public, when a mark has a strong distinctive character (para. 24).

**22/06/2000, [C-425/98](#), *Marca*, EU:C:2000:339**

- The reputation of a mark does not give grounds for presuming the existence of a likelihood of confusion simply because of the existence of a likelihood of association in the strict sense (para. 41).
- [Article 5\(1\)\(b\)](#) of [Directive 2008/95/EC](#) cannot be interpreted as meaning that where:
  - a trade mark has a particularly distinctive character, either per se or because of the reputation it enjoys with the public, and
  - a third party, without the consent of the proprietor of the mark, uses, in the course of trade in goods or services that are identical with, or similar to, those for which the trade mark is registered, a sign that so closely corresponds to the mark as to give the possibility of its being associated with that mark,

the exclusive right enjoyed by the proprietor entitles him to prevent the use of the sign by that third party if the distinctive character of the mark is such that the possibility of such association giving rise to confusion cannot be ruled out (emphasis added) (para. 42).

**06/10/2005, [C-120/04](#), *Thomson Life*, EU:C:2005:594**

- Where the goods or services are identical there may be a likelihood of confusion on the part of the public where the contested sign is composed by juxtaposing the company name of another party and a registered mark that has normal distinctiveness and which, without alone determining the overall impression conveyed by the composite sign, still has an independent distinctive role therein (para. 37).

***GUIDELINES FOR EXAMINATION OF  
EUROPEAN UNION TRADE MARKS***

***EUROPEAN UNION  
INTELLECTUAL PROPERTY OFFICE  
(EUIPO)***

***Part C***

***Opposition***

***Section 2***

***Double identity and likelihood of confusion***

***Chapter 2***

***Comparison of goods and services***

## Table of Contents

<b>1 Introduction.....</b>	<b>883</b>
1.1 Relevance.....	883
1.2 Nice Classification: a starting point.....	884
1.2.1 Its nature as a classification tool.....	884
1.2.2 Its structure and methodology.....	884
1.2.3 Conclusions to be drawn from the structure of the Nice Classification.....	885
1.2.4 Changes in the classification of goods/services.....	886
1.3 The Similarity Tool for the comparison of goods/services.....	886
1.4 Definition of goods and services (terminology).....	887
1.4.1 Goods.....	887
1.4.2 Services.....	887
1.4.3 Products.....	888
1.5 Determining the goods/services.....	888
1.5.1 Correct wording.....	888
1.5.2 Scope of goods/services in comparison.....	890
1.6 Objective approach.....	895
1.7 Statement of reasons.....	896
<b>2 Identity.....</b>	<b>896</b>
2.1 General principles.....	896
2.2 Identical terms or synonyms.....	897
2.3 Terms included in the general indication or broad category.....	898
2.3.1 The earlier mark includes the goods/services of the contested mark.....	898
2.3.2 The contested mark includes the goods/services of the earlier mark.....	899
2.4 Overlap.....	900
2.5 Practice on the use of general indications of the class headings.....	901
<b>3 Similarity of Goods and Services.....</b>	<b>904</b>
3.1 General principles.....	904
3.1.1 Similarity factors.....	904
3.1.2 Defining relevant factors.....	905
3.2 The specific similarity factors.....	906
3.2.1 Nature.....	906
3.2.2 Intended purpose.....	908
3.2.3 Method of use.....	909
3.2.4 Complementarity.....	909
3.2.5 In competition.....	916

3.2.6 Distribution channel.....	916
3.2.7 Relevant public.....	917
3.2.8 Usual origin (producer/provider).....	918
3.3 Relation between different factors.....	920
3.3.1 Interrelation of factors.....	921
3.3.2 Importance of each factor.....	921
3.3.3 Different types of comparisons: goods versus goods, services versus services and goods versus services.....	922
3.3.4 Degree of similarity.....	922
<b>4 Annex I: Specific Questions on the Similarity of Goods and Services.....</b>	<b>924</b>
4.1 Parts, Components and Fittings.....	924
4.2 Raw Materials and Semi-Processed Goods.....	924
4.3 Accessories.....	925
4.4 Installation, Maintenance and Repair Services.....	926
4.5 Advisory, Consultancy and Information Services.....	926
4.6 Rental and Leasing.....	927
4.6.1 Rental/leasing versus related services.....	928
4.6.2 Rental/leasing versus goods.....	928
4.7 Examples of unclear and imprecise terms.....	928
<b>5 Annex II: Specific Industries.....</b>	<b>930</b>
5.1 Chemicals, Pharmaceuticals and Cosmetics.....	930
5.1.1 Chemicals (Class 1) versus chemical products (Classes 3 and 5).....	930
5.1.2 Pharmaceuticals versus pharmaceuticals.....	930
5.1.3 Pharmaceuticals versus cosmetics.....	931
5.2 Automobile Industry.....	931
5.3 Fashion and Textile Industries.....	932
5.3.1 Raw or semi-processed materials versus finished goods.....	932
5.3.2 Textile goods (Class 24) versus clothing (Class 25).....	932
5.3.3 Fashion accessories.....	933
5.4 Food, Beverages and Restaurant Services.....	933
5.4.1 Foodstuffs.....	933
5.4.2 Ingredients of prepared food.....	934
5.4.3 Non-alcoholic beverages (Class 32) versus alcoholic beverages (except beers) (Class 33).....	934
5.4.4 Provision of food and drinks versus food and drinks.....	935
5.5 Services to Support Other Businesses.....	936
5.6 Retail Services.....	939
5.6.1 Retail services versus any good.....	939



5.6.2 Retail services of goods versus goods.....	939
5.6.3 Retail services versus retail services or retail services of specific goods.....	941
5.6.4 Retail services of specific goods versus retail services of other specific goods.....	941
5.6.5 Services to which the same principles apply.....	941
5.6.6 Services to which the same principles do not apply.....	941
5.7 Transport, Packaging and Storage.....	942
5.8 Information Technology.....	942
5.8.1 Software versus apparatus/services that use software.....	942
5.8.2 Specific software versus specific software.....	942
5.8.3 Communications equipment, computers and software (Class 9) versus telecommunication services (Class 38).....	943

## 1 Introduction

### 1.1 Relevance

The comparison of goods and services is primarily of relevance for the assessment of identity according to [Article 8\(1\)\(a\) EUTMR](#) and likelihood of confusion according to [Article 8\(1\)\(b\) EUTMR](#). One of the main conditions for [Article 8\(1\)\(a\) EUTMR](#) is the identity of goods/services, while [Article 8\(1\)\(b\) EUTMR](#) requires the identity or similarity of goods/services. Consequently, if all goods/services are found to be dissimilar, one of the conditions contained in [Article 8\(1\) EUTMR](#) is not fulfilled and the opposition must be rejected without addressing the remaining sections of the decision <sup>(51)</sup>.

The criteria for the assessment of identity or similarity might also play a role when proof of use has been requested and the evidence has to be assessed in order to conclude whether the opponent has proven use for the goods/services as registered. In particular, it is important to determine whether the goods and services for which the mark has been used belong to the category of goods and services for which the trade mark was registered. This is because, under [Article 47\(2\) EUTMR](#), proof of use for a product or service that is merely similar to the one registered does not prove use for the registered product or service (see the Guidelines, [Part C, Opposition, Section 7, Proof of Use](#)).

Likewise, evidence of use of goods/services might also be relevant when examining a claim to enhanced distinctiveness. In such cases it is often necessary to examine whether the enhanced distinctiveness covers goods/services for which the earlier trade mark enjoys protection and that are relevant for the specific case, that is to say, that have been considered to be identical or similar to the goods/services of the contested EUTM (see the Guidelines, [Part C, Opposition, Section 2, Double Identity and Likelihood of Confusion, Chapter 5, Distinctiveness of the Earlier Mark](#)).

Furthermore, the outcome of the comparison of goods/services plays an important role in defining the part of the public for whom likelihood of confusion is analysed because the relevant public is that of the goods/services found to be identical or similar (see the Guidelines, [Part C, Opposition, Section 2, Double Identity and Likelihood of Confusion, Chapter 3, Relevant Public and Degree of Attention](#)).

The comparison of goods/services may also be relevant under [Article 8\(3\) EUTMR](#), which requires the identity or close relation or equivalence in commercial terms of goods/services (see the Guidelines, [Part C, Opposition, Section 3, Unauthorised Filing by Agents of the TM Proprietor \(Article 8\(3\) EUTMR\)](#)), and under the applicable provisions of national law under [Article 8\(4\) EUTMR](#), since identity or similarity of the goods/services is often a condition under which the use of a subsequent trade mark may be prohibited (see the Guidelines, [Part C, Opposition, Section 4, Non-registered](#)

---

<sup>51</sup> Equally, the comparison of goods and services is of relevance in invalidity proceedings, since pursuant to [Article 60\(1\)\(a\) EUTMR](#), a registered European Union trade mark is declared invalid where the conditions set out in [Article 8\(1\) EUTMR](#) are fulfilled.

[trade marks and other signs used in the course of trade \(Article 8\(4\) EUTMR\)](#). Furthermore, under [Article 8\(5\) EUTMR](#), the degree of similarity or dissimilarity between the goods/services is a factor that must be taken into account when establishing whether or not the consumer will perceive a link between the marks. For example, the goods/services may be so manifestly dissimilar that use of the later mark on the contested goods/services is unlikely to bring the earlier mark to the mind of the relevant public (see the Guidelines, [Part C, Opposition, Section 5, Trade Marks with Reputation \(Article 8\(5\) EUTMR\)](#)).

## 1.2 Nice Classification: a starting point

[Article 33\(1\) EUTMR](#) requires that the goods/services to be compared are classified according to the Nice Classification. Currently the Nice Classification consists of 34 classes (1-34) for categorising goods and 11 classes (35-45) for categorising services.

### 1.2.1 Its nature as a classification tool

The Nice Classification was set up with the aim of harmonising national classification practices. Its first edition entered into force in 1961. Although it has undergone several revisions, it sometimes lags behind the rapid changes in product developments in the markets. Furthermore, the wording of the headings is at times unclear and imprecise.

The Nice Classification serves purely administrative purposes and, as such, does not in itself provide a basis for drawing conclusions as to the similarity of goods and services.

According to [Article 33\(7\) EUTMR](#), the fact that goods/services are listed in the same class of the Nice Classification is not, in itself, an indication of similarity.

#### Examples

- *Live animals* are dissimilar to *flowers* (Class 31).
- *Advertising* is dissimilar to *office functions* (Class 35).

The fact that two specific goods/services fall under the same general indication of a class heading does not per se make them similar, let alone identical: *cars* and *bicycles* — although both fall under *vehicles* in Class 12 — are considered dissimilar.

Furthermore, goods/services listed in different classes are not necessarily considered dissimilar (16/12/2008, [T-259/06](#), Manso de Velasco, EU:T:2008:575, § 30-31).

#### Examples

- *Meat extracts* (Class 29) are similar to *spices* (Class 30).
- *Travel arrangement* (Class 39) is similar to *providing temporary accommodation* (Class 43).

### 1.2.2 Its structure and methodology

Classification may serve as a tool to identify the common characteristics of certain goods/services.

Many classes of the Nice Classification are structured according to factors such as function, composition and/or purpose of use, which may be relevant in the comparison of goods/services. For example:

- Class 1 comprises chemical goods based primarily on their chemical properties (nature), rather than on their specific application. By contrast, Class 3 covers all items that are either cleaning preparations or for personal hygiene or beautification. Although they can by their nature also be classified as chemical products, it is their specific purpose that allows a distinction and thus a different classification.
- Equally, it is because of their nature that most items made of leather are classified in Class 18, whereas clothing made of leather falls under Class 25 since it serves a very specific purpose, namely that of being worn by people and as protection from the elements.

### 1.2.3 Conclusions to be drawn from the structure of the Nice Classification

The structure of the class headings is not uniform and does not follow the same logic. Some classes consist of only one general indication that by definition already covers nearly all the goods/services included in this class (Class 15 *musical instruments*; Class 38 *telecommunications*). Others include many general indications – some very broad and others very specific. For example, the heading of Class 9 includes more than 30 terms, ranging from *scientific apparatus and instruments* to *fire-extinguishing apparatus*.

Exceptionally, there are class headings containing general indications that include another general indication and are thus identical.

Example: *materials for dressings* in Class 5 include *plasters* in Class 5.

Other specific indications in a class heading are only mentioned to clarify that they do not belong to another class.

Example: *adhesives used in industry* are included in *chemicals used in industry* in Class 1. Its mention is mainly thought to distinguish them from *adhesives* classified in Class 16, which are for stationery or household purposes.

To conclude, the Nice Classification gives indications that can be used in the assessment of identity or similarity of goods/services. However, its structure and content is not consistent. Therefore, each heading or specific term has to be analysed according to the specific class under which it is classified. As stated before, the Nice Classification mainly serves to categorise goods/services for administrative purposes and is not decisive for their comparison.

However, it is apparent from case-law that, even though the Nice Classification was adopted for exclusively administrative purposes, the explanatory notes on the different classes of that classification are relevant in determining the nature and purpose of the goods and services in question. In particular, where the description of the goods or services for which a mark is registered is so general that it may cover very different goods or services, it is possible to take into account, for the purposes of interpretation or as a precise indication of the designation of the goods or services, the classes in the

classification that the trade mark applicant has chosen (06/10/2021, [T-397/20](#), Juvederm, EU:T:2021:653, § 35).

Nevertheless, where the specification for which a mark is registered already clearly designates specific goods/services, that wording must be taken into account and is decisive when determining the scope of protection. This is so even if the specification designates goods/services that would correctly belong to a class that is different from the class in which they were registered (see, to this effect, 06/10/2021, [T-397/20](#), Juvederm, EU:T:2021:653, § 45).

For example, if the general term *tea* has been registered in Class 5, the class number chosen must be taken into account to determine its precise scope of protection – *tea* in this class can only be considered to be *tea for medicinal purposes* since ordinary tea belongs to Class 30. However, if the specific term *medicinal tea* has been registered in Class 30, the scope of protection of that term will still be precisely that of its usual meaning, namely *tea for medicinal purposes*, even though such goods correctly belong to Class 5.

#### 1.2.4 Changes in the classification of goods/services

Normally, each revision of the Nice Classification brings changes in the classification of goods/services (in particular transfers of goods/services between various classes) or in the wording of headings. In such cases the list of goods/services of both the earlier and the contested mark must be interpreted according to the edition of the Nice Classification in force at the time of filing.

##### Example

- *Legal services* were transferred from Class 42 to Class 45 with the 8th edition of the Nice Classification. The nature of these services has not changed.
- *Vending machines* were transferred from Class 9 to Class 7 in the 10th edition of the Nice Classification, since a vending machine is basically a powered machine and as such was considered more appropriately classified in Class 7 with other machinery. However, since the nature of these goods has not changed, *vending machines* classified in different classes due to the different filing dates of the respective applications are regarded as identical.

### 1.3 The Similarity Tool for the comparison of goods/services

The [Similarity Tool](#) for the comparison of goods and services is a search tool to help and support examiners and EUIPO users in assessing the similarity of goods and services. The Similarity Tool serves to harmonise practice on the assessment of similarity of goods and services and to guarantee the coherence of decisions. The Similarity Tool must be followed by examiners.

The Similarity Tool is based on comparing specific pairs of goods and services. A 'pair' compares two 'terms'. A 'term' consists of a class number from the Nice Classification (1-45) and a textual element, that is to say, a specific product or service (including

general categories of goods and services, such as *clothing* or *education*). There are five possible results of the search: identity, high degree of similarity, similarity, low degree of similarity and dissimilarity. For each of the degrees of similarity, the tool indicates which criteria lead to each result.

The Similarity Tool is constantly updated and revised as necessary in order to create a comprehensive and reliable source of reference.

Since the tool gives answers to specific comparisons, the Guidelines concentrate on defining the general principles and their application in practice.

## 1.4 Definition of goods and services (terminology)

The EUTMR does not define goods and services. Although the Nice Classification gives some general explanations to this effect in its introductory remarks, it does not clearly set any criteria for distinguishing between goods and services.

### 1.4.1 Goods

In principle, the word 'goods' refers to any kind of item that may be traded. Goods comprise raw materials (unprocessed plastics in Class 1), semi-finished products (plastics in extruded form for use in manufacture in Class 17) and finished products (plastic household containers in Class 21). They include natural and manufactured goods, such as agricultural products in Class 31 and machines and machine tools in Class 7.

However, sometimes it is not clear whether goods comprise only tangible physical products as opposed to services, which are intangible. The definition and thus the scope of protection are particularly relevant when it comes to 'goods', such as *electricity*, that are intangible. This question is already answered during the examination on classification and will not usually cause any problems in the comparison of goods and services.

### 1.4.2 Services

A service is any activity or benefit that one party can offer to another that is intangible and does not result in the transfer of ownership of any physical object. In contrast to goods, a service is **always** intangible.

Importantly, services comprise economic activities provided to **third parties**.

- Advertising one's own goods is not a service but running an advertising agency (designing advertising campaigns for third parties) is. Similarly *shop window dressing* is only a service when provided for third parties, not when done in one's own shop.
- Selling, storing or distributing one's own goods is not a service. Retail services are meant to cover the services around the actual sale of goods, such as providing the

customer with an opportunity to conveniently see, compare or test the goods. For more detailed information, see Annex II, [paragraph 5.6, Retail Services](#).

One indication for an activity to be considered a service under trade mark law is its independent economic value, that is to say, it is usually provided in exchange for some form of (monetary) compensation. Otherwise, it could be a mere ancillary activity provided together with or after the purchase of a specific product.

#### Example

- Delivery, including the transport of furniture that has previously been purchased (either in a physical establishment or online), is not an independent service falling under *transport services* in Class 39.

However, the intention to make profit is not necessarily a criterion for defining whether an activity can qualify as a 'service' (09/12/2008, [C-442/07](#), Radetzky, EU:C:2008:696, § 16-18). It is more a question of whether the service has an independent market area and targeted public rather than the way or form in which compensation is made for it.

### 1.4.3 Products

In common parlance the term 'products' is used for both goods and services, for example, 'financial products' instead of financial services. Whether terms in common parlance are described as 'products' is immaterial to them being classified as goods/services.

## 1.5 Determining the goods/services

### 1.5.1 Correct wording

As a preliminary, the correct wording of the lists of goods/services under consideration must be identified.

#### 1.5.1.1 European Union trade marks

An application for an EUTM will be published in all the official languages of the European Union ([Article 147\(1\) EUTMR](#)). Likewise, all entries in the Register of European Union trade marks (the Register) will be in all these languages ([Article 147\(2\) EUTMR](#)). Both applications and entries in the Register are published in the EUTM Bulletin ([Article 116\(1\)\(a\)](#) and [Article 116\(2\) EUTMR](#)).

In practice, occasional discrepancies may be found between:

- the translation of the wording of the list of goods/services of an EUTM (application or registration) published in the EUTM Bulletin, and
- the original wording as filed.

In cases of such discrepancy, the definitive version of the list of goods and services is:

- the text in the first language, if the first language is one of the five languages of the Office.
- the text in the second language indicated by the applicant ([Article 147\(3\) EUTMR](#)), if the first language of the application is not one of the five languages of the Office.

This applies regardless of whether the EUTM (or EUTM application) is the earlier right or the contested application.

Where an incorrect translation of the list of goods and services is detected in an EUTM application that prevents the Office from carrying out a comparison of the goods and services, the list will either be sent for translation again or, in clear-cut cases, changed directly in the Register. The Office will take its decisions on the basis of the correct translation. Where an incorrect translation is detected in a registered EUTM, the Office will explain which language version of the goods and services is the definitive version for the purposes of the comparison. See also in this respect the Guidelines, [Part C, Opposition, Section 1, Opposition proceedings, paragraph 7.1.2, Correction of mistakes and errors in publications](#).

#### 1.5.1.2 Earlier national marks and international registrations

The list of goods and services of the earlier marks on which the opposition is based must be submitted in the language of the opposition proceedings ([Article 7\(4\) EUTMDR](#)). The Office does not require any certified translation; it accepts simple translations, drawn up by the opponent or its representative. The Office normally does not exercise the option available under [Article 26 EUTMR](#) of requiring the translation to be certified by a sworn or official translator. Where the representative adds a declaration that the translation is true to the original, the Office will in principle not question this. The other party may, however, question the correctness of the translation during the adversarial part of the proceedings. (See the Guidelines, [Part C, Opposition, Section 1, Opposition proceedings](#).)

For international registrations the language in which the international registration was registered is definitive (English, French or Spanish). However, where the language of the opposition procedure is not the language of the international registration, a translation must be supplied, as for earlier national marks.

Where a clearly incorrect translation is detected in the list of goods and services covered by the earlier national or international mark that prevents the Office from carrying out a comparison of goods and services, the opponent may be required under [Article 26 EUTMR](#) to submit a certificate from a sworn or official translator confirming that the translation corresponds to the original. Alternatively, in clear-cut cases, the Office may, for the purposes of the decision, replace a clearly incorrect translation of a certain term by a correct translation, adding an explanation to that effect. For example, where the term ‘bars’ in Class 43 is translated as *barras de cereales* (cereal bars), it is a clearly incorrect translation as this term could never fall within Class 43.



### 1.5.2 Scope of goods/services in comparison

Comparison of the goods and services must be based on the wording indicated in the respective lists of goods/services. Any actual or intended use not stipulated in the list of goods/services is not relevant for this comparison since it is part of the assessment of likelihood of confusion in relation to the goods/services on which the opposition is based and against which it is directed; it is not an assessment of actual confusion or infringement (16/06/2010, [T-487/08](#), Kremezin, EU:T:2010:237, § 71).

However, if proof of use of the earlier mark is validly requested and the submitted evidence is sufficient for only part of the goods/services listed, the earlier mark is deemed to be registered for only those goods/services ([Article 47\(2\) EUTMR](#)); consequently, the examination is restricted to those goods/services (see the Guidelines, [Part C, Opposition, Section 7, Proof of Use](#)).

Moreover, in the case of the earlier mark, only the goods and services on which the opposition is validly based are pertinent. Hence, no account will be taken of goods/services:

- that cannot be taken into account for reasons of admissibility;
- that have not been properly substantiated (e.g. only a partial translation of the list of goods/services was filed); or
- on which the opposition is not, or is no longer, based.

Similarly, only those goods and services of the contested application against which the opposition is directed are taken into consideration. Consequently, restrictions applied during the proceedings to either the list of goods/services of the application or the goods/services on which the opposition is based, or both, will limit the goods and services to be compared.

Furthermore, an analysis of the wording of the list of goods/services might be required to determine the scope of protection of those goods and services. This is especially true where terms such as **in particular**, **namely**, or equivalents are used in order to show the relationship of an individual product with a broader category.

The term **in particular** (or **for example**, **such as**, **including** or other equivalent) indicates that the specific goods/services are only examples of items included in the category, and that protection is not restricted to them. In other words, it introduces a non-exhaustive list of examples (on the use of **in particular**, see the reference in 09/04/2003, [T-224/01](#), Nu-Tride, EU:T:2003:107).

However, the term **namely** (or **exclusively** or other equivalent) is exclusive and restricts the scope of the application/registration to only the specifically listed goods/services.

For example, in the case of *chemicals used in industry*, **namely raw materials for plastics** only the *raw materials for plastics* need to be compared with the goods of the other mark.

On the contrary, in the case of *chemicals used in industry*, **in particular raw materials for plastics**, only the broad category of *chemicals used in industry* need be compared with the goods of the other mark.

The use of commas in the list of goods/services serves to separate items within the same or a similar category. The use of a semicolon means a separation between terms. The separation of terms by different punctuation can lead to changes in their meaning and may lead to a different assessment when comparing the goods/services. For more information on punctuation in lists of goods and services, see the Guidelines, [Part B, Examination, Section 3, Classification](#).

For example, in *computer software for use with industrial machines; fire extinguishers* in Class 9, the inclusion of a semicolon means that the term *fire extinguishers* must be considered as an independent category of goods, regardless of whether the intention was to protect computer software to be used in the field of industrial machines and fire extinguishers.

#### 1.5.2.1 Meaning of terms in list of goods/services

Once the wording of the goods/services to be considered has been identified, its meaning must be determined.

In some cases, the exact meaning is immediately obvious from the list of goods/services, where a more or less detailed description of the goods/services is generally given. For example, the wording *belts, being articles of clothing* excludes by definition safety and industrial belts.

In case of doubt about the exact meaning of the terms used in the list of goods/services, the scope of protection of those terms has to be determined according to their natural and usual meaning and interpreted both in the light of the Nice Classification and from a commercial perspective. Therefore, *belts* in Class 25 are, owing to their classification, *articles of clothing*.

*Clothing*, for instance, refers to 'clothes collectively' (*Oxford Dictionaries* online edition). Therefore, it refers to items worn to cover the body, such as shirts, dresses and trousers. Although the definition of clothing found in standard dictionaries does not explicitly exclude *footwear*, the latter appears in the Nice Classification as a separate item in the same class (Class 25). This leads to the conclusion that *clothing* and *footwear* are not identical but similar (13/07/2004, [T-115/02](#), 'a' in a black ellipse, EU:T:2004:234, § 26).

However, this does not mean that two general indications in one class heading can never be considered identical. As mentioned above, the structure of the class headings is not uniform. Some general indications included in the class headings may encompass others.

#### Example

- *Meat and poultry* (Class 29) are identical.

### 1.5.2.2 Unclear and imprecise terms

An analysis of the wording of the list of goods/services is also required where the wording or term used is **not sufficiently clear and precise** to enable the competent authorities and economic operators to determine, on that sole basis, the scope of protection given to the mark. This is the case where the wording or term used is too general and covers goods/services that are too variable to be compatible with the trade mark's function as an indication of origin (19/06/2012, [C-307/10](#), IP Translator, EU:C:2012:361, § 54). This means that it is not possible to infer with a reasonable degree of certainty which specific goods/services are actually covered, as the wording or general term does not, in itself, sufficiently reveal the commercial nature and attributes of the goods/services to be covered, such as their intended purpose, method of use, the relevant public targeted, the distribution channels, relevant market sector or usual commercial origin.

In such cases the Office will first verify whether goods/services are considered to be unclear or imprecise due to an incorrect translation of the original list. If so, the Office will take different steps depending on whether the unclear or imprecise term is contained in the specification of the EUTM (regardless of whether the EUTM (or EUTM application) is the earlier right or the contested application) or of the national or international mark on which the opposition is based. The provisions contained in paragraphs [1.5.1.1](#) and [1.5.1.2](#) apply.

If the lack of clarity and precision is not the result of an incorrect translation but the term is unclear or imprecise in itself and does not sufficiently reveal the commercial nature and attributes of the goods/services to be covered, and if there is no limitation (or partial surrender) enabling the Office to clearly determine the exact scope of protection, different steps must be taken, depending on whether the unclear or imprecise term is contained in the earlier mark or the contested mark (see paragraphs [1.5.2.2.1](#) and [1.5.2.2.2](#) respectively).

The general indications from the Nice Class Headings and other examples of terms and expressions lacking clarity and precision can be found in [Annex I: Specific Questions on the Similarity of Goods and Services, paragraph 4.7](#). General indications considered to lack the necessary clarity and precision have been identified by the Office in conjunction with the national offices of the European Union (see [Common Communication on the Acceptability of Classification Terms and the General Indications of the Nice Class Headings \(CP1\)](#)). Furthermore, the requirement of clarity and precision of the specification of goods and services has been clarified in case-law interpreting the Harmonisation Directive (07/07/2005, [C-418/02](#), Praktiker, EU:C:2005:425, § 49, 51; 19/06/2012; [C-307/10](#), IP Translator, EU:C:2012:361, § 38-49). Consequently, even if the earlier mark is a national (or Benelux or international) registration, it is within the Office's competence to interpret its scope of protection in relative grounds proceedings before the Office. As such, when the Office concludes that a particular term covered by an earlier national mark does not meet the requirement of clarity and precision, it will apply the necessary consequences accordingly, as set out in paragraph [1.5.2.2.1](#).

In any event, it is in the interests of trade mark holders (applicants or owners) to clarify unclear or imprecise terms and thus precisely determine the scope of protection; they can do this through explicit restriction or partial surrender. See also the Guidelines, [Part B, Examination, Section 3, Classification, paragraphs 5.3.1 – 5.3.3](#).

1.5.2.2.1 *Unclear or imprecise term(s) in list of goods/services covered by earlier mark*

Unclear or imprecise terms in the earlier mark may not be excluded from the outset in the comparison of goods and services simply by invoking a lack of clarity and precision (04/03/2020, [C-155/18 P](#) – [C-158/18 P](#), BURLINGTON / BURLINGTON ARCADE, EU:C:2020:151, § 134). However, these terms can only be taken into account in their most natural and usual sense. Unclear or imprecise terms may not be construed as constituting a claim to goods/services that cannot be covered by this meaning without further specification. As a result, unless the same (or a synonymous) unclear and imprecise term is used in the specification of both marks (see [paragraph 2.1](#)), lack of clarity and precision of wording is not a sufficient basis in itself for arguing in support of identity or similarity where the Office is unable to clearly determine the exact scope of protection of unclear or imprecise terms. Nor may an unclear or imprecise term be interpreted in relation or by reference to other goods/services within the same class or different classes.

Consequently, while unclear or imprecise terms in the earlier mark will be compared with the contested goods/services, taking into account the similarity factors (as specified in detail in paragraphs [3.1](#) to [3.3](#)), no similarity can be found when the natural and literal meaning of an unclear or imprecise term cannot be understood to lead to a coincidence in relevant similarity factors with the contested goods/services.

For example, while the unclear and imprecise term *machines* can be understood in its natural meaning as ‘equipment which uses electricity or an engine in order to do a particular kind of work’ (*Collins English Dictionary*), this abstract meaning does not sufficiently reveal its specific commercial nature, that is to say what machines or types of machines are meant to be covered. Machines can have different characteristics or different purposes, may require very different levels of technical capabilities and know-how to be produced and/or used, could target different consumers and be sold through different sales channels, and therefore relate to different market sectors.

As a result, when comparing the unclear and imprecise term *machines* with, for example, *dual combustion machines for use in agriculture*, the lack of clarity and precision of the first term cannot be used on its own for arguing identity or similarity; nor can the term be construed as relating to ‘dual combustion’ machines or to machines ‘for use in agriculture’ when such qualities or methods of use have not been expressly identified in the specification and cannot be understood from its natural and literal meaning. It follows that, while the terms may be compared and be considered to have the same abstract nature insofar as they are machines, they cannot, on the basis of the insufficient information and facts provided by the imprecise specification of the earlier mark, be considered to have the same purpose or methods of use, or to be

complementary to each other or in competition. Furthermore, they cannot be considered to target the same relevant public, share the same distribution channels or be usually produced by the same undertakings. Consequently, unless the unclear and imprecise term *machines* is further specified, the goods cannot be considered either identical or similar.

However, if an unclear or imprecise term is followed by another term that expressly identifies goods/services by way of an example (e.g. *machines, in particular agricultural machines* or *repair services, in particular vehicle repair*), a comparison may also be made between that specific term (*agricultural machines* or *vehicle repair*) and the goods/services of the contested mark (25/06/2020, [T-114/19](#), B (fig.) / b (fig.), EU:T:2020:286, § 51, 53). This could lead to coincidence in relevant similarity factors between that specific term and the contested goods/services.

Unclear or imprecise terms in the earlier mark can also be clarified by means of a partial surrender by the trade mark proprietor, which would facilitate comparison with the goods/services of the contested mark, and might lead to identity or similarity being found between the goods/services under comparison, based on the relevant criteria as specified in paragraphs [3.1](#) to [3.3](#). If the earlier mark is a European Union trade mark registration, (partial) surrender is governed by the rules set out in [Article 57 EUTMR](#). For national marks, a partial surrender should be filed with the corresponding authority, which will be responsible for determining whether it can be accepted.

Furthermore, if an earlier mark that contains an unclear or imprecise term is subject to proof of use, and proof of use is requested in accordance with [Article 47\(2\) – and \(3\) – EUTMR](#), the evidence submitted establishing genuine use of the mark in relation to specific goods/services may also clarify the scope of goods/services covered by an otherwise unclear and imprecise term (29/01/2020, [C-371/18](#), SKY, EU:C:2020:45, § 70). In such circumstances, a comparison will be made on the basis of the specified scope of goods/services for which genuine use has been proven. See also the Guidelines, [Part C, Opposition, Section 7, Proof of Use, paragraph 6.3.4.1](#).

#### 1.5.2.2.2 *Unclear or imprecise term(s) in list of goods/services covered by contested mark*

As set out in [Article 33\(2\) EUTMR](#), the EUTM applicant must identify the goods and services for which trade mark protection is sought with sufficient clarity and precision. According to [Article 193\(1\) EUTMR](#), this applies equally to the holder of an international registration designating the European Union.

Therefore, unless the same (or a synonymous) unclear and imprecise term is used in the specification of both marks (see [paragraph 2.1](#)), the Office will, where the contested mark contains an unclear or imprecise term, reopen examination of the classification of the mark under [Article 33 EUTMR](#) (or where applicable under [Article 193 EUTMR](#) and if possible) and suspend the opposition proceedings accordingly (27/02/2014, [T-229/12](#), Vogue, EU:T:2014:95, § 55). See also the Guidelines, [Part B, Examination, Section 3, Classification, paragraph 5.5](#).

The applicant may at any time clarify an unclear or imprecise term by restricting the list of goods/services contained in the application, as long as the ensuing specification is sufficiently clear and precise and does not extend the scope of protection ([Article 49 EUTMR](#)). The holder of an international registration designating the European Union may also restrict the list of goods/ services in accordance with Article 9*bis*(iii) of the Madrid Protocol; the restricted list will then be examined in the same way as one for an EUTM application. See also the Guidelines, [Part C, Opposition, Section 1, Opposition Proceedings, paragraph 6.2](#) and the Guidelines, [Part M, International Marks, paragraph 3.8](#).

## 1.6 Objective approach

The comparison of the goods/services in question must be made **without** taking into account the degree of similarity of the conflicting signs or the distinctiveness of the earlier mark. It is only in the overall assessment of a decision that the examiners will take into account all the relevant factors.

The classification of the goods/services is not conclusive, because similar goods/services may be classified in different classes, whereas dissimilar goods/services may fall within the same class.

Identity or similarity of the goods/services in question must be determined on an objective basis.

It is necessary to base the findings on the realities of the marketplace, such as established customs in the relevant field of industry or commerce. These customs, especially trade practices, are dynamic and constantly changing. For instance, mobile phones nowadays combine many functions, such as being communication tools as well as photographic apparatus.

The degree of similarity of the goods and services is a matter of law, which must be assessed *ex officio* by the Office even if the parties do not comment on it (16/01/2007, [T-53/05](#), Calvo, EU:T:2007:7, § 59). However, the Office's *ex officio* examination is restricted to well-known facts, that is to say, 'facts which are likely to be known by anyone or which may be learned from generally accessible sources', which excludes facts of a highly technical nature (03/07/2013, [T-106/12](#), Alpharen, EU:T:2013:340, § 51). Consequently, what does not follow from the evidence/arguments submitted by the parties or is not commonly known should not be speculated on or extensively investigated *ex officio* (09/02/2011, [T-222/09](#), Alpharen, EU:T:2011:36, § 31-32). This follows from [Article 95\(1\) EUTMR](#), according to which, in opposition proceedings, the Office is restricted in its examination to the facts, evidence and arguments provided by the parties and the relief sought. (See the Guidelines, [Part C, Opposition, Section 2, Double Identity and Likelihood of Confusion, Chapter 1, General Principles](#)).



## 1.7 Statement of reasons

The examiner is required to state reasons for the outcome of the comparison (identity, similarity or dissimilarity) for each of the individual goods and services specified in the application for registration. However, the examiner may use only general reasoning for groups of the goods/services concerned as long as the goods/services present analogous characteristics (see, by analogy, 18/03/2010, [C-282/09 P](#), P@yweb card / Payweb card, EU:C:2010:153, § 37-38; 12/04/2011, [T-28/10](#), Euro automatic Payment, EU:T:2011:158, § 54; 17/10/2013, [C-597/12 P](#), Zebexir, EU:C:2013:672, § 26-27).

## 2 Identity

### 2.1 General principles

Identity is generally defined as ‘the quality or condition of being the same in substance, composition, nature, properties, or in particular qualities under consideration’ (*Oxford Dictionaries* online edition).

Identity exists not only when the goods and services completely coincide (the same terms or synonyms are used), but also when and insofar as the contested mark’s goods/services fall within a broader category covered by the earlier mark, or when and insofar as – conversely – a broader term of the contested mark includes the more specific goods/services of the earlier mark. In this respect, the notion of a broad category of goods and services is not necessarily limited to a single term (e.g. clothing in Class 25), but may also encompass several terms. For example, *building and construction materials and elements, not of metal* in Class 19 and *software development, programming and implementation* in Class 42 can be considered to be broad categories of goods and services respectively.

There might also be identity when two broad categories under comparison coincide partially (‘overlap’) (see examples in [paragraph 2.4](#)). Hence a distinction can be made between cases of ‘full identity’ and ‘partial identity’.

Identity should not be established on the basis of similarity factors (see [paragraph 3.1.1](#)) or on the basis of an unclear and imprecise term in an earlier mark, as it is not possible to infer with a reasonable degree of certainty what specific goods/services, that is to say what kind of goods/services, are actually covered by those terms (see [paragraph 1.5.2.2.1](#) and the list of examples of unclear and imprecise terms in [Annex I: Specific questions on the similarity of goods and services, paragraph 4.7](#)). However, where the same (or a synonymous) unclear and imprecise term is used in both marks, such as *machines*, the terms coincide completely and therefore must be considered identical.

## 2.2 Identical terms or synonyms

Identity between the goods/services in dispute must be established on the basis of the wording of the relevant parts of the lists of goods/services of the two marks that have been identified in accordance with the general principles set out in [paragraph 2.1](#). Identity is obvious where the goods/services to be compared are listed in exactly the same terms.

### Example

- *Vehicles* are identical to *vehicles*.

Where this is not the case, the terms of the respective lists of goods/services must be interpreted in order to show that they are in fact synonyms, that is to say, that their meaning is the same. The interpretation can be made based on dictionary definitions, expressions from the Nice Classification and, in particular, by taking into account the commercial perspective.

### Examples

- *Bicycle* is a synonym for *bike*. The goods are identical.
- The meaning of the words *smokers' articles* in Class 34 refers to individual objects that are used in close connection with tobacco or tobacco products. In former editions of the Nice Classification these products were called *smokers' requisites*. Therefore, despite a different term used in the class heading, these goods are identical.
- From a commercial perspective, *health spa services* and *beauty spa services* are the same and are therefore identical.

However, if identical wording is used but the goods are classified in different classes, this generally means that these goods are not identical.

### Examples

- *Drills* (machine tools) in Class 7 are not identical to *drills* (hand tools) in Class 8.
- *Lasers* (not for medical treatment) in Class 9 are not identical to *lasers* (for curative purposes) in Class 10.

Even though they might be similar, the classification in different classes indicates that they have different characteristics, such as different nature, purpose or method of use, etc.

The same reasoning does not apply if the different classification is only due to a revision of the Nice Classification or where it is clear that the goods/services are wrongly 'classified' due to an obvious mistake.

### Examples

- *Playing cards* (Class 16 — 7th edition) are identical to *playing cards* (Class 28 — 10th edition).



- *Pharmaceutical preparations* (Class 15) — an obvious typing error — are identical to *pharmaceutical preparations* (Class 5).

## 2.3 Terms included in the general indication or broad category

### 2.3.1 The earlier mark includes the goods/services of the contested mark

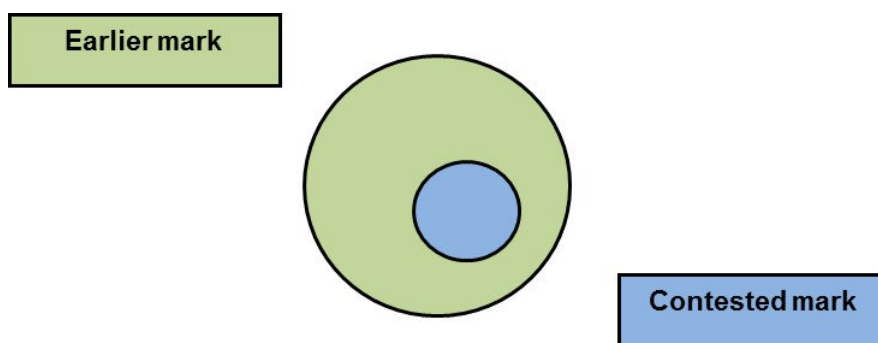

Where the list of goods/services of the earlier right includes a general indication or a broad category that covers the goods/services of the contested mark in their entirety, the goods/services will be identical (17/01/2012, [T-522/10](#), Hell, EU:T:2012:9, § 36).

#### Examples

- *Temporary accommodation* (earlier right, Class 43) includes *youth hostel services* (contested mark, Class 43). Therefore, the services are identical.
- *Pasta* (earlier right, Class 30) includes *spaghetti* (contested mark, Class 30). The conflicting goods are considered identical.

However, the same reasoning cannot apply where the earlier mark contains a general indication or other general term considered to lack the necessary clarity and precision (see the list of examples in [Annex I: Specific Questions on the Similarity of Goods and Services, paragraph 4.7](#)). It is not possible, on the basis of an unclear and imprecise term, to infer with a reasonable degree of certainty what specific goods/services, that is to say what kind of goods/services, are actually covered by the term since the latter does not, in itself, sufficiently reveal the specific commercial nature and attributes of the goods/services that are meant to be covered, such as their intended purpose, method of use, the relevant public targeted, the distribution channels, relevant market sector or usual commercial origin. Therefore, where the earlier mark contains an unclear and imprecise term, it should be interpreted accordingly (see [paragraph 1.5.2.2.1](#)).

## 2.3.2 The contested mark includes the goods/services of the earlier mark

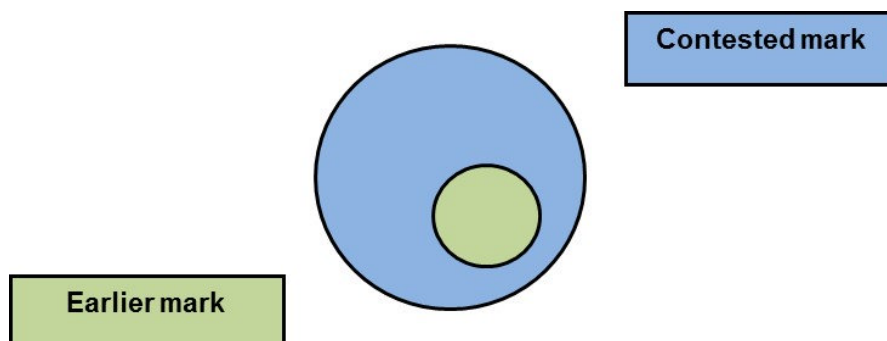

If the goods/services designated in the earlier mark are covered by a general indication or broad category used in the contested mark, these goods/services must be considered identical since the Office cannot dissect *ex officio* the broad category of the applicant's/holder's goods/services (07/09/2006, [T-133/05](#), Pam-Pim's Baby-Prop, EU:T:2006:247, § 29).

Examples

- The earlier mark's *jeans* (Class 25) are included in *articles of clothing* (contested mark, Class 25). The goods are considered identical.
- The earlier mark's *bicycles* (Class 12) are included in *vehicles* (contested mark, Class 12). The goods are considered identical.

The applicant/holder may, however, restrict the list of goods/services in a way that excludes identity, but could still lead to similarity (24/05/2011, [T-161/10](#), E-Plex, EU:T:2011:244, § 22).

- The earlier mark's *jeans* (Class 25) are included in *articles of clothing* (Class 25). The applicant/holder restricts the specification to *articles of clothing, excluding jeans*. The goods are no longer identical but remain similar.
- The earlier mark's *bicycles* (Class 12) are included in *vehicles* (contested mark, Class 12). The applicant/holder restricts the specification to *vehicles, namely automobiles*. The goods are no longer identical or similar.

If the applicant/holder does not restrict the list of goods/services, or does not do so sufficiently, the Office will treat the contested mark's general indication or broad term/category as a single unit and find identity.

If the contested mark covers a general indication or a broad term/category as well as specific items that fall under that general indication or broad term/category, all of these will need to be compared with the specific earlier goods/services. The result of identity found with the general indication or broad term/category does not automatically extend to the specific items.

Example

- The contested mark covers *vehicles* (general indication) as well as *bicycles, aircraft, trains* (included in vehicles). Where the earlier mark is protected for *bicycles*, identity will be found with respect to *vehicles* and to *bicycles* but not for *aircraft or trains*.

However, if the contested mark covers a general indication or broad term/category and specific terms that are not listed independently but only as examples of goods/services included in that general indication or broad term/category, the comparison differs insofar as it is not necessary to compare the specific examples of goods/services listed, but only the general indication or broad term/category for which protection was sought or for which it was registered (03/07/2013, [T-205/12](#), LIBERTE american blend, EU:T:2013:341, § 27).

Example

- The contested mark covers *vehicles, in particular bicycles, aircraft, trains*. The earlier mark is protected for *bicycles*. The goods in conflict are considered identical, since the broad category of *vehicles* includes *bicycles* and the specific examples of goods listed after that broad category do not need to be compared.

The applicant/holder can avoid this result by deleting the general indication *vehicles*, the expression *in particular*, and the specific category *bicycles*.

Where the list of goods/services of the contested mark reads: *vehicles, namely bicycles, aircraft, trains*, the comparison differs insofar as only the specific items have to be compared. In this case only the contested *bicycles* are identical to the earlier goods.

## 2.4 Overlap

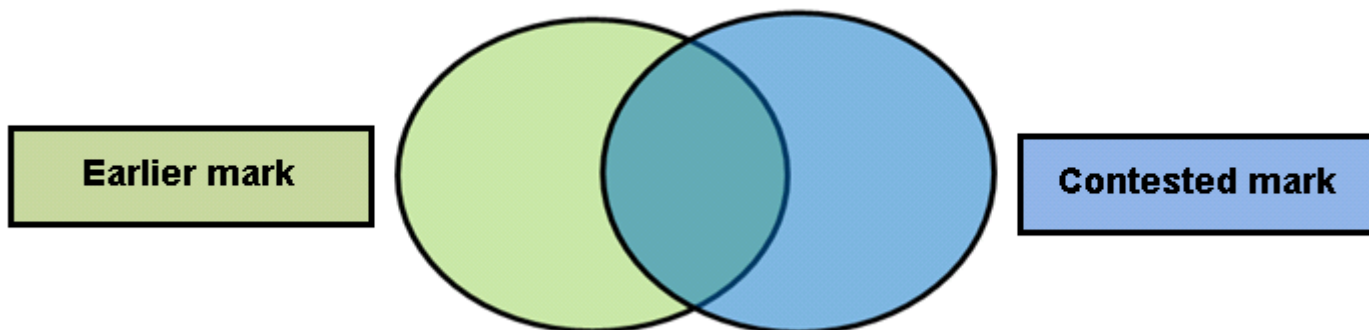

If two categories of goods/services coincide partially ('overlap') there might be identity if:

1. they are classified in the same class; and
2. it is impossible to clearly separate the two goods/services.

Examples

Earlier goods	Contested goods	Coinciding part
<i>Outdoor clothing for women</i> (Class 25)	<i>Clothing made of leather</i> (Class 25)	Outdoor clothing made of leather for women

<i>Components and spare parts for land vehicles</i> (Class 12)	<i>Vehicle seats</i> (*) (Class 12)	Seats for land vehicles
<i>Bread</i> (Class 30)	<i>Long-life bakery products</i> (Class 30)	Long-life bread
<i>Soap</i> (Class 3)	<i>Cleaning preparations, other than for personal use</i> (Class 3)	Soaps for household cleaning purposes
<i>Scientific instruments</i> (Class 9)	<i>Optical instruments</i> (Class 9)	Scientific optical instruments, e.g. microscopes
<i>Online banking services</i> (Class 36)	<i>Commercial banking services</i> (Class 36)	Online commercial banking services
(*) 09/09/2008, <a href="#">T-363/06</a> , Magic seat, EU:T:2008:319, § 22.		

In such cases, it is impossible for the Office to filter these goods from the abovementioned categories. Since the Office cannot dissect *ex officio* the broad category of the applicant's/holder's goods, they are considered to be identical.

In the fourth example given above, the outcome changes, of course, if *soap* is limited to *soaps for personal use*. In this case the goods are no longer included in the category of *cleaning preparations, other than for personal use* in Class 3 since the latter are only for household use.

Furthermore, where the earlier mark contains a general indication or other general term considered to lack the necessary clarity and precision, no overlap can be found on the basis of that term (see the list of examples in [Annex I: Specific questions on the similarity of goods and services, paragraph 4.7](#)). It is not possible to infer with a reasonable degree of certainty what specific goods/services, that is to say what kind of goods/services, are actually covered by an unclear and imprecise term, as the latter does not, in itself, sufficiently reveal the specific commercial nature and attributes of the goods/services that are meant to be covered, such as their intended purpose, method of use, the relevant public targeted, the distribution channels, relevant market sector or usual commercial origin. Therefore, where the earlier mark contains an unclear and imprecise term, it should be interpreted accordingly (see [paragraph 1.5.2.2.1](#)).

## 2.5 Practice on the use of general indications of the class headings

According to Article 33(3) EUTMR, the Office does not object to the use of any of the general indications of the class headings provided that these identifications are sufficiently clear and precise <sup>(52)</sup>.

<sup>52</sup> See the Common Communication on the Acceptability of Classification Terms and the General Indications of the Nice Class Headings ([CP1](#)).

According to [Article 33\(5\) EUTMR](#), the use of general terms or general indications of the class headings will be interpreted as including all the goods/services clearly covered by the literal meaning of the indication or term. The use of such terms will not be interpreted as comprising a claim to goods/services that cannot be understood as such.

In this respect, as regards the general indications of the class headings considered to lack the necessary clarity and precision (see [Annex I: Specific questions on the similarity of goods and services, paragraph 4.7](#)), it is not possible to infer with a reasonable degree of certainty what specific goods/services, that is to say what kind of goods/services, are actually covered by those general indications since the latter do not, in themselves, sufficiently reveal the specific commercial nature and attributes of the goods/services that are meant to be covered, such as their intended purpose, method of use, the relevant public targeted, the distribution channels, relevant market sector or usual commercial origin. These specific general indications of the class headings should therefore be interpreted accordingly (see [paragraph 1.5.2.2](#)).

Under [Article 33\(8\) EUTMR](#), during the 6-month period ending on 24/09/2016, proprietors of European Union trade marks filed before 22/06/2012 and registered for the entire heading of a Nice class had the opportunity to declare that their intention at the time of filing had been to cover goods/services going beyond the literal meaning of that class heading, provided that the goods/services declared were included in the alphabetical list for the class of the edition of the Nice Classification in force on the date of filing.

During that 6-month period, Communication of the President No 2/12 of 20/06/2012 remained in force and therefore trade marks filed before 22/06/2012 and registered for an entire class heading were considered to cover the literal meaning of the general indications, as well as the goods and services of the alphabetical list of that class, in the edition of the Nice Classification in force at the time of filing.

According to [Article 33\(8\) EUTMR](#), last sentence, from the expiry of the 6-month period following the entry into force of the Amending Regulation, all European Union trade marks registered in respect of the entire heading of a Nice class for which no declaration has been filed, will be deemed to extend only to goods/services clearly covered by the literal meaning of the indications included in the heading of the relevant class.

Declarations for European Union trade marks filed within the relevant period will take effect from the moment of their entry in the Register.

Where the declaration is accepted and the Register is amended, [Article 33\(9\) EUTMR](#) will apply.

According to [Article 33\(9\) EUTMR](#), the amendment of a list of goods/services recorded in the Register following a declaration under [Article 33\(8\) EUTMR](#) made during the 6-month period after the entry into force of the Regulation cannot give the proprietor of a European Union trade mark the right to oppose or to apply for a declaration of invalidity in respect of a later mark where and to the extent that (i) the later trade mark was in use for, or an application had been made to register the later trade mark for, goods/

services before the Register was amended for the earlier mark and (ii) the use in relation to those goods/services did not infringe, or would not have infringed, the proprietor's rights based on the literal meaning of the record of the goods/services in the Register at that time.

In practice, this means that, where the earlier mark is a European Union trade mark and the contested mark was filed, or was in use, before the Register was amended under [Article 33\(8\) EUTMR](#) for the earlier European Union trade mark, the goods and services identified as going beyond the literal meaning of the class heading will not be taken into account in oppositions or declarations of invalidity filed after the entry into force of the Amending Regulation.

As regards the scope of protection of national marks, the Office and all national trade mark offices of the European Union issued a Common Communication on the Interpretation of Scope of Protection of Nice Class Headings (formerly *Implementation of 'IP Translator'*) ([CP2](#)). According to that Communication, the Office interprets the scope of protection of national marks containing class headings as follows:

- **Earlier national trade marks filed before the *IP Translator* judgment:** in principle, the Office accepts the filing practice of all national trade mark offices in the European Union. National trade marks filed before the *IP Translator* judgment have the scope of protection awarded by the national office(s) concerned. The majority of the national offices interpret the class headings of their marks literally. For those marks, the Office also interprets the class headings on the basis of the natural and usual meaning of each general indication.
- Only five <sup>(53)</sup> national trade mark offices do not interpret the class headings of their own marks filed before the *IP Translator* judgment on the basis of their natural and usual meaning: Bulgaria, Greece, Italy, Lithuania and Hungary (see Table 3.1 of the Common Communication). The Office interprets the scope of protection of those national trade marks as including the goods and services covered by the literal meaning of the general indications and those included in the alphabetical list for those classes of the Nice edition at the time of filing (even though some of the national offices interpret the class heading as covering all goods and services in the class).
- **Earlier national marks filed after the *IP Translator* judgment:** the Office interprets all goods and services covered by the national marks on the basis of their

---

<sup>53</sup> Although the scope of protection of Finnish trade marks filed before the *IP Translator* judgment is ultimately to be interpreted only on the basis of the literal meaning of the general indications, owners of such trade marks filed before 1 October 2012 can specify the scope of protection intended at the date of filing. This further specification must be made no later than on the date on which the application for the renewal of the mark is filed for the first time after the transposition of the Trade Marks Directive (TMD) (i.e. as of 1 May 2019). Effectively, such declarations can be filed until 31 October 2029. Consequently, it is only after any such renewal that the goods/services covered by the mark are to be interpreted only on the basis of their literal meaning. Prior to the expiry of this renewal date, the Office will interpret the scope of protection of the relevant national trade marks in Finland as including the goods/services covered by the literal meaning of the general indications and those included in the alphabetical list of the relevant classes.

For example, unless the scope of protection has already been further specified by the owner, a trade mark filed in 2008 and renewed on 1 February 2018 (i.e. before the transposition of the TMD) will be interpreted as including the goods/services covered by the literal meaning of the general indications and those included in the alphabetical list of the relevant classes until the first renewal date subsequent to 1 May 2019 has expired. Therefore, in this case it is only after 1 February 2028 that the scope of protection of such a trade mark will be interpreted only on the basis of the literal meaning of the general indications of the relevant classes.

natural and usual meaning (see Table 3.3 of the Common Communication). However, for some earlier national marks, declarations made by the applicant claiming protection for the full alphabetical list may also have to be taken into account if recorded in their respective registers (<sup>54</sup>).

The abovementioned principles have to be applied to determine the scope of protection. Only those goods/services deemed to be covered following these principles will be considered when comparing the goods/services.

## 3 Similarity of Goods and Services

### 3.1 General principles

#### 3.1.1 Similarity factors

Generally speaking, two items are defined as being similar when they have some characteristics in common. The similarity of goods and services does not depend on any specific number of criteria that could be determined in advance and applied in all cases.

The similarity of goods and services has been addressed in the case-law of the Court of Justice in *Canon* (29/09/1998, [C-39/97](#), Canon, EU:C:1998:442). The Court of Justice held that in assessing the similarity of goods **all** the relevant factors relating to those goods themselves should be taken into account. Those factors include, *inter alia*, their nature, their intended purpose, their method of use and whether they are in competition with each other or are complementary (para. 23).

The term **inter alia** shows that the enumeration of the above factors by the Court is only indicative. There may be other factors in addition to or instead of those mentioned by the Court that may be pertinent, depending on the particular case.

This leads to the conclusion that the following factors should be taken into account:

#### Canon factors

- nature
- intended purpose
- method of use
- complementarity
- competition.

#### Additional factors

- distribution channels

---

<sup>54</sup> In Bulgaria, Benelux, Finland (until 31 December 2013), Greece, Hungary, Italy, Lithuania and Romania applicants could obtain protection for the full alphabetical list by completing a declaration without the terms being listed individually (see Table 6 of the [previous version](#) of the Common Communication on the Interpretation of Scope of Protection of Nice Class headings (formerly Implementation of 'IP Translator') published on 20 February 2014 (version 1.2).



- relevant public
- the usual origin of the goods/services.

These factors will be further explained in [paragraph 3.2](#); they are also used in the [Similarity tool](#) for the comparison of goods and services. It should be noted, however, that even though the database is restricted to these eight factors, there might be specific cases where other criteria are relevant.

### 3.1.2 Defining relevant factors

The comparison should focus on identifying the relevant factors that specifically characterise the goods/services to be compared. Therefore, the relevance of a particular factor depends on the respective goods/services to be compared.

#### Example

- When comparing *skis* and *ski-boots*, it is evident that they do not coincide in their nature or method of use and are not in competition. Therefore, the comparison should focus on their purpose, their complementary character, their distribution channels, their usual origin and/or the relevant public.

Therefore, the relevant factors and features characterising a product or a service may be different depending on the goods and services with which they have to be compared.

It is not necessary to list all possible factors. What does matter, however, is whether the connections between the relevant factors are sufficiently close to find similarity.

The following questions could be asked:

- How will the goods/services be used?
- What is their purpose?
- How likely is it that they coincide in producers/providers?
- Are they usually found in the same outlet or department store, or in the same section of a supermarket?

If the factors cannot already be defined from the wording of the goods/services, information may be derived from dictionary entries. However, dictionary entries have to be analysed against commercial realities and in particular taking into account the Nice Classification.

#### Example

- According to the dictionary, 'ice' means, inter alia, 'frozen water' [uncountable] or '...an ice cream' [countable] (*Collins English Dictionary*). Therefore, if the comparison of *ice* and *ices* in Class 30 were made on the basis of dictionary definitions alone, it would lead to the conclusion that *ices* are identical to *ice* to the extent that the former is included in the latter. However, both *ices* and *ice* have always been separate general indications in different parts of the heading of Class 30 where *ices* clearly refer to 'edible ices' whereas *ice* has always been meant to denote 'cooling ice'. Indeed, to clarify this, *ice* in the class heading has subsequently been amended to 'ice [frozen water]'. As a result, the literal meaning



of the term *ice* within the context of the Nice Classification must be understood as referring only to 'cooling ice'<sup>55</sup>.

Once the relevant factors have been identified, the examiner must determine the relationship between and the weight attributed to the relevant factors (see [paragraph 3.3](#)).

## 3.2 The specific similarity factors

The following paragraphs define and illustrate the various factors for similarity of goods and services.

### 3.2.1 Nature

The nature of a product/service can be defined as the essential qualities or characteristics by which this product/service is recognised. Nature often corresponds to the particular type or sort of product/service or the specific category to which this product/service belongs and which is usually used to define it. In other words, it is the answer to the question 'What is it?'

#### Examples

- *Yoghurt* is a milk product;
- *Car* is a vehicle;
- *Body lotion* is a cosmetic product.

#### 3.2.1.1 Indicative value of class headings and categories

The fact that goods/services to be compared fall under the same general indication of a class heading or broad category does not automatically mean that they are of the same nature. An example of such a broad category is *foodstuffs for human consumption*.

#### Examples

- *Fresh fruit* (Class 31) on the one hand and *coffee, flour, and bread* (Class 30) on the other hand are of a different nature despite being foodstuffs.
- *Meat, fish, poultry and game* (Class 29) are foodstuffs of animal origin. *Fruits and vegetables* (Class 31) are foodstuffs of plant origin. This slight connection, namely all being foodstuffs, does not preclude that their nature is different.

The fact that goods/services to be compared fall under a sufficiently narrow general indication of a class heading favours an identical or similar nature.

#### Example

---

<sup>55</sup> This distinction between 'ices' and 'ice' is clear from the different terms used in the original French version in the 1st edition of the Nice Classification, namely 'glaces comestibles' and 'glace' respectively. This understanding is also confirmed by the 4th edition in which the term 'glace' was amended to 'glace à rafraîchir' for further clarification.

- *Condensed milk* and *cheese* (both in Class 29) share the same nature because they belong to the same product category, namely milk products, which are a subcategory of foodstuffs (4/11/2003, [T-85/02](#), Castillo, EU:T:2003:288, § 33).

### 3.2.1.2 Features of the goods defining their nature

A variety of features of the goods in question may be useful for defining their nature. These include the following:

**Composition:** for example, ingredients, materials of which the goods are made.

#### Example

- *Yoghurt* (Class 29) is a milk product (the nature of yoghurt may be defined by its basic ingredient).

Composition may be the most relevant criterion for defining nature. However, an identical or similar composition of the goods is not per se an indicator of the same nature.

#### Example

- A *chair* (Class 20) and a *doll* (Class 28) can both be made of plastic, but they are not of the same nature since one is a piece of furniture and the other is a toy. They belong to different categories.

**Functioning principle:** for example, mechanical functioning, with or without engine/motor; optical, electrical, biological, or chemical functioning.

#### Example

- *Telescope* (Class 9) is an optical device (the nature of a telescope may be defined by its functioning principle, which is optical).

Although the functioning principle may help to define the nature of some goods, it is not always conclusive. There are cases where goods, in particular technology-related ones, with the same functioning principle are of a different nature.

#### Example

- A *blender* and an *electric toothbrush* have the same functioning principle of rotation, but they are not of the same nature.

In contrast, there are goods with different functioning principles but the same nature.

#### Example

- The functioning principle of *washing machines using washing powder* is chemical, which is not the same as the functioning principle of *washing machines using magnetic waves*. However, these goods are of the same nature as they are both washing machines.

**Physical condition:** for example, liquid/solid, hard/soft, flexible/rigid.

The physical condition is another feature of the goods that may be used to define nature but, like the functioning principle, it is not conclusive.

### Examples

- All drinks are liquid. Their nature is different from the nature of solid foodstuffs. However, when comparing two different drinks, their physical condition should not be conclusive: *milk* (Class 29) is not of the same nature as an *alcoholic beverage* (Class 33).
- *Yoghurt* is marketed both in solid and liquid form. However, the nature of this good is not defined by its physical condition, but — as mentioned above — by its basic ingredient (milk). In both cases, the nature of a solid yogurt and of a liquid yogurt is the same (a milk product).

#### 3.2.1.3 Nature of services

When defining the nature of services, the composition of features, functioning principle and physical condition cannot be used since services are intangible.

The nature of services can be defined, in particular, by the kind of activity provided to third parties. In most cases, it is the category under which the service falls that defines its nature.

#### Example

- *Taxi services* (Class 39) have the same nature as *bus services* (Class 39) as they are both transport services.

#### 3.2.1.4 Nature of goods versus nature of services

By their **nature**, goods are generally dissimilar to services. This is because goods are articles of trade, wares or merchandise. Their sale usually entails the transfer in title of something physical. Services, however, consist of the provision of intangible activities.

#### 3.2.2 Intended purpose

‘Purpose’ is generally defined as ‘the reason for which something is done or made, or for which it exists’ (*Oxford Dictionaries* online edition).

As a Canon factor, purpose means the intended use of the goods/services and not any other possible use.

#### Example

- A *plastic bag* can be used as protection against the rain. However, its intended purpose is to carry items.

The purpose is defined by the function of the goods/services. In other words, it answers the questions: What need do these goods/services satisfy? What problem do they solve?

It is sometimes difficult to determine the proper level of abstraction in order to determine the purpose. As in the case of defining the nature, the purpose must be defined in a sufficiently narrow way.

### Example

- In the case of *vinegar*, the intended purpose should not be defined as ‘human consumption’, which is the general purpose that all foodstuffs share, but as ‘everyday seasoning’.

### 3.2.3 Method of use

The method of use determines the way in which the goods/services are used to achieve their purpose.

The question to be asked is: How are these goods/services used?

Method of use often follows directly from the nature and/or intended purpose of the goods/services and therefore has little or no significance of its own in the similarity analysis.

### Example

- The method of use of newspapers and books is the same in the sense that they are both read. However, similarity can already be concluded from the facts that they are both printed matter (same nature) and that they both serve to entertain or to inform (same purpose).

Notwithstanding the explanation above, the method of use may be important, independent of nature and purpose, where it characterises the goods.

### Example

- *Pharmaceutical preparations for treating skin diseases* in Class 5 can take the form of creams. They have the same method of use as *cosmetic creams* in Class 3.

However, even where the method of use characterises the goods under comparison and where it is identical for both goods, this fact alone will not be sufficient to establish similarity.

### Example

- *Chewing gum* (Class 30) and *chewing tobacco* (Class 34) have an identical method of use. However, this fact alone does not make them similar.

### 3.2.4 Complementarity

Goods (or services) are complementary if there is a close connection between them, in the sense that one is indispensable (essential) or important (significant) for the use of the other in such a way that consumers may think that responsibility for the production of those goods or provision of those services lies with the same undertaking (11/05/2011, [T-74/10](#), Flaco, EU:T:2011:207, § 40; 21/11/2012, [T-558/11](#), Artis, EU:T:2012:615, § 25; 04/02/2013, [T-504/11](#), Dignitude, EU:T:2013:57, § 44).

## 3.2.4.1 Connection (link) between goods/services

The connection between the goods/services must be established with sufficient certainty. When the connection between the goods/services is not close enough for each to be indispensable (essential) or important (significant) for the use of the other, no complementarity can be found.

When assessing whether or not the consumer would usually expect there to be a link between the goods/services, it is appropriate to take into account the economic reality on the market as it currently exists (16/01/2018, [T-273/16](#), METAPORN / META4 et al., EU:T:2018:2, § 41-42).

A **functional link** between goods/services will usually be a strong indication of complementarity: for instance when one product or service is required for the proper functioning of the other, one enables the use of the other, or one cannot be used without the other.

In the following cases there is complementarity between the goods under comparison.

Examples

- *Software, in particular for casino and amusement arcade games* in Class 9 is essential for the functioning of *games* (such as electronic or online games of chance) in Class 28 and there is complementarity between the goods (19/04/2016, [T-326/14](#), HOT JOKER / JOKER et al., EU:T:2016:221, § 54).
- The sole purpose of *cord and cable management devices* (such as holders and clips for containing and organising audio and video cables) in Class 9 is for them to be used with *electric wires and cables* (such as AV cables) in Class 9, as the former are used for holding and organising the latter. It follows that there is an undeniable link of complementarity between them (24/04/2018, [T-831/16](#), ZOOM / ZOOM et al., EU:T:2018:218, § 81-82).
- *Applicators for hair lotions* (Class 21) complement *hair lotions* (Class 3) and are used for applying the latter properly (16/12/2015, [T-356/14](#), Kerashot / K KERASOL, EU:T:2015:978, § 37).

There may also be a link between a certain product on the one hand, and its parts, components and fittings on the other. There is therefore complementarity when the respective part/component/fitting is sold independently and is required for proper use of the final product and/or when the part/component/fitting cannot serve its intended purpose if it is not included in the final product. In the following examples the goods are considered complementary.

Examples

- *electric toothbrushes* (Class 21) and *replacement brush heads* (Class 21);
- *power saws* (Class 7) and *saw blades* (Class 7);
- *lighting apparatus* (Class 11) and *lighting fittings* (Class 11).

Principles applicable to the comparison of various kinds of goods/services among themselves also apply to the comparison between goods on the one hand and services

on the other. Moreover, there may be similarity based on complementarity between goods on the one hand and services that cover identical goods on the other (24/09/2008, [T-116/06](#), O Store, EU:T:2008:399, § 54-56, 07/09/2016, [T-204/14](#), VICTOR / VICTORIA et al., EU:T:2016:448, § 108-111).

In the following cases there is complementarity between the goods and services under comparison.

#### Examples

- *Installation, repair and maintenance of water based heating systems* in Class 37 ensure the proper functioning of *heating installations* in Class 11 (such as water-based heating installations); there is complementarity between them (06/06/2018, [T-264/17](#), SMATRIX / AsyMatrix (fig.), EU:T:2018:329, § 49-50).
- *Design and development of computer hardware and software* in Class 42 are important for the functioning of *computers; portable communication devices* in Class 9; there is complementarity between them (27/09/2016, [T-450/15](#), luvoworld / luvu, EU:T:2016:543, § 42, 46, 48-49).
- There is complementarity between, on the one hand, *soaps, perfumery, essential oils, cosmetics, hair lotions* in Class 3 and, on the other, *spas, Turkish baths, sauna services, health spa services* in Class 44. Treatments in spas, Turkish baths and health spas are usually followed by the application of body lotions and moisturising creams, and the public may expect to be treated with these products in such establishments (26/02/2015, [T-388/13](#), SAMSARA, EU:T:2015:118, § 30). In that case, the goods in Class 3 are important for proper use of the services in Class 44.
- In the comparison of *retail services in stores of all kinds of foodstuffs, especially patisserie and confectionery* contained in Class 35, with various kinds of foodstuffs falling within Classes 29, 30 and 31, the retail services relate to a relatively broad category of goods that includes the goods covered by the other mark. Consequently, the retail services and the goods covered by the other mark were found to be complementary (05/05/2015, [T-715/13](#), Castello (fig.) / Castelló y Juan S.A. (fig.) et al., EU:T:2015:256, § 29-31). In this case the services in Class 35 are important for providing consumers with the goods in Classes 29, 30 and 31.
- *Medical services* in Class 44 are important, even indispensable, for the use of *pharmaceutical products* in Class 5. Similarly, administering pharmaceutical products is important, even indispensable, in providing the services in question. There is a complementarity between these goods and services (14/06/2018, [T-165/17](#), EMCURE / Emcur et al., EU:T:2018:346, § 60-61).

#### 3.2.4.2 Additional factors for establishing a link between goods and services

There is complementarity between goods and services only when the consumers of the goods and services concerned may think that the same undertaking is responsible for producing those goods or providing those services. In that sense, the relevant public and usual commercial origin of the goods and services are important factors for establishing complementarity.

### The relevant public

By definition, complementary goods or services must be capable of being used together, so that goods and services directed at different publics cannot be complementary (22/01/2009, [T-316/07](#), easyHotel, EU:T:2009:14, § 57-58; 22/06/2011, [T-76/09](#), Farma Mundi Farmaceuticos Mundi, EU:T:2011:298, § 30; 12/07/2012, [T-361/11](#), Dolphin, EU:T:2012:377, § 48; 26/04/2016, [T-21/15](#), DINO (fig.) / DEVICE OF A DINOSAUR (fig.), EU:T:2016:241, § 22; 15/06/2017, [T-457/15](#), climaVera (fig.) / CLIMAVER DECO, EU:T:2017:391, § 36), even if they are considered mutually indispensable (25/01/2017, [T-325/15](#), Choco Love (fig.) / CHOCOLATE, EU:T:2017:29, § 40, 43, 46).

### Examples

- *Textile products* in Class 24 (aimed at the public at large) and *treatment services relating to textile products* in Class 40 (aimed at professionals) cannot be complementary (16/05/2013, [T-80/11](#), Ridge Wood, EU:T:2013:251, § 28-32). These goods and services are not similar.
- The relevant public of plastic or synthetic products used as raw or semi-finished material (e.g. *synthetic resin plastics* in Class 1 and *plastics in extruded form* in Class 17) consists of moulders and converters, whereas the finished products (e.g. *vehicles* made in Class 12) are directed at the general public. The goods at issue are not complementary (09/04/2014, [T-288/12](#), Zytel, EU:T:2014:196, § 28, 41). There is no similarity between them.

There will be no complementarity between a certain product on the one hand, and its parts, components or fittings on the other, when the goods in comparison do not target the same public (e.g. the component is meant for the manufacturer, but not for the consumer of the final product) and when the parts, components or fittings are not usually sold independently as replacement parts of the final product. Therefore, in the following examples, even though the parts or components are indispensable or important for the proper functioning of the final product, there is no complementarity between the goods in comparison.

### Examples

- *fan blades* (Class 7) and *hair dryer* (Class 11);
- *electric cable* (Class 9) and *lamp* (Class 11);
- *balls for ball-point pens* (Class 16) and *ball-point pens* (Class 16).

### The origin of the goods/services

Goods/services that are complementary usually share the same commercial origin, or give consumers some cause to believe that the same undertaking is responsible for both producing the goods and providing the services.

### Examples

- *Skis* (Class 28) and *ski boots* (Class 25) are complementary because the use of one is indispensable for the use of the other. The relevant public may think that the production of these goods lies with the same undertaking. In addition, they share the



same public and distribution channels. These goods are consequently considered similar.

- *Teaching materials* in Class 9 (e.g. *downloadable electronic publications, audio and video files, pre-recorded data carriers and audio/video cassettes*) and Class 16 (e.g. *printed matter*) are essential and thus complementary to *educational services* in Class 41. Generally the materials are provided by the same undertaking, and share the same public and distribution channels. These goods are similar to the services in question (23/10/2002, [T-388/00](#), ELS, EU:T:2002:260; 22/04/2008, [T-233/06](#), El tiempo, EU:T:2008:121, § 36-37).
- *Services of an architect (designing of buildings)* (Class 42) are indispensable for *building construction* (Class 37). These services are often offered together through the same distribution channels, by the same providers and to the same public. Consequently, these services are complementary and similar (09/04/2014, [T-144/12](#), Comsa / COMSA S.A., EU:T:2014:197, § 65-67).

Conversely, there is no complementarity between goods/services that are not expected to share the same commercial origin.

#### Example

- There is no complementarity between financial and banking services (Class 36) on the one hand and real estate services (Class 36) on the other. Banking services may play a significant role in the purchase of a property, but it cannot be inferred from that alone that consumers would be led to believe that the same undertaking was responsible for real estate services. To conclude otherwise would imply that any non-financial procedure that depends on the provision of financing is complementary to a financial service. Furthermore, the services do not have the same nature, the same intended purpose or the same method of use, and they are not provided on the same premises. Consequently, these services are not similar. (17/09/2015, [T-323/14](#), Bankia / BANKY, EU:T:2015:642, § 35, 37-38).

#### 3.2.4.3 Types of interrelation between goods/services where complementarity is usually not found

In the following cases there is not usually any complementarity between the goods/services, as neither is indispensable or important for the use of the other, and any joint use of them is a question of convenience or of consumer habits or preferences.

#### Use in combination

Complementarity has to be clearly distinguished from **use in combination** where goods/services are merely used together, whether by choice or convenience, but can be used also without the other or with different goods (e.g. bread and butter). Where their use together is merely optional and not indispensable or important, the necessary close link is missing (28/10/2015, [T-736/14](#), MoMo Monsters / MONSTER et al., EU:T:2015:809, § 29). In such cases similarity can be found on the basis only of other factors, not complementarity.

#### Example



- Although *confectionery, candy, biscuits, wafer rolls, pastries, crisps* or *bread* in Class 30 may be accompanied by beverages in Classes 29, 30 or 32, their use is neither indispensable nor important for the consumption of *dairy-based, coffee, coffee-based beverages* or *beer* or vice versa, even if the relevant public would be likely to consume them together. Consequently, there is no close connection between those goods and they cannot be considered complementary (28/10/2015, [T-736/14](#), MoMo Monsters/ MONSTER et al., EU:T:2015:809, § 28-29; 24/10/2019, [T-498/18](#), Happy Moreno choco (fig.) / MORENO (fig), EU:T:2019:763, § 63; 12/12/2019, [T-648/18](#), Crystal / CRISTAL, EU:T:2019:857, § 42).
- Even if the functioning of *transmission belts* in Class 12 can be measured with the help of a *device for motor-vehicle testing* in Class 9, this does not mean that the goods are complementary. It can be convenient in certain cases to measure the performance of one or the other parameter but simple convenience is not sufficient to conclude that one product is indispensable for the other (03/10/2013, [R 1011/2012-4](#), SUN (fig.) / SUN (fig.) et al., § 39).

#### Aesthetic complementarity

It cannot be excluded that in some sectors, such as the fashion and body and facial care sectors, goods whose nature, purpose and/or method of use are different, apart from being functionally complementary, may be considered ‘aesthetically complementary’ in the eyes of the relevant public (11/07/2007, [T-150/04](#), Tosca Blu, EU:T:2007:214, § 35). The General Court defines ‘aesthetic complementarity’ as a connection between the products that ‘must involve a true aesthetic necessity, in the sense that one product is indispensable or important for the use of the other and consumers consider it ordinary and natural to use those products together’ (11/07/2007, [T-150/04](#), Tosca Blu, EU:T:2007:214, § 36; 20/10/2011, [T-214/09](#), Cor II, EU:T:2011:612, § 32; 25/09/2018, [T-435/17](#), HIPANEMA (fig.) / Ipanema (fig.) et al., EU:T:2018:596, § 53). Therefore, the following elements have to be considered.

- The connection between the goods is subjective. Their aesthetically complementary nature is determined by the habits and preferences of consumers, to which producers’ marketing strategies or even simple fashion trends may give rise (27/09/2012, [T-357/09](#), Emidio Tucci, EU:T:2012:499, § 51; 12/02/2015, [T-505/12](#), B, EU:T:2015:95, § 59; 25/09/2018, [T-435/17](#), HIPANEMA (fig.) / Ipanema (fig.) et al., EU:T:2018:596, § 53).
- Aesthetic complementarity may apply when the goods in question have a common aesthetic function by jointly contributing to, for example, the external image of the consumer concerned, and the relevant public considers it ordinary and natural to use the goods together. Aesthetic complementarity between certain goods can be found when it is common customer behaviour to aesthetically coordinate the goods concerned, even though how the goods are combined is ruled by preferences (as the products could serve their intended purpose independently from one another).

#### Examples

- *Handbags* in Class 18, on one hand and *clothing and footwear* in Class 25, on the other hand, share a common aesthetic function by jointly contributing to the consumer’s ‘look’. Any such coordination depends on the consumer concerned, the

type of activity for which that look is put together, in particular for work, sport or leisure, or the marketing strategies of the businesses in the sector (11/07/2007, [T-443/05](#), Pirañam, EU:T:2007:219, § 49; 27/09/2012, [T-39/10](#), Pucci, EU:T:2012:502, § 76). It is, however, common customer behaviour to aesthetically combine these goods when purchasing them, and their aesthetic coordination may also be considered at the design stage.

- *Carpets* in Class 27 and *furniture* in Class 20 are used in home decoration and have a common aesthetic function that leads consumers, as a general rule, to use them together and to match them with each other, so as to create a harmonious atmosphere (20/10/2011, [T-214/09](#), Cor II, EU:T:2011:612, § 33).

Even when acknowledged, the mere existence of ‘aesthetic complementarity’ between the goods is not sufficient on its own to conclude that there is similarity between them (27/09/2012, [T-39/10](#), Pucci, EU:T:2012:502, § 75). For similarity to be found, consumers must consider it usual for the goods to be sold under the same trade mark, which normally implies that a large number of the producers or distributors of the goods are the same (01/03/2005, [T-169/03](#), Sissi Rossi, EU:T:2005:72, § 63; 11/07/2007, [T-150/04](#), Tosca Blu, EU:T:2007:214, § 37; 20/10/2011, [T-214/09](#), Cor II, EU:T:2011:612, § 34).

#### Ancillary goods

When certain goods/services only support or supplement another product or service, they are not considered to be complementary within the meaning of the case-law.

**Ancillary goods** are typically those used for packaging (e.g. bottles, boxes, cans) or for promotion (e.g. leaflets, posters, price lists). Equally, goods/services offered for free in the course of a merchandising campaign are usually not similar to the primary product or service.

#### Examples

- *Organisation and conducting of exhibitions* (Class 41) is not similar to *printed matter, including event notes* (Class 16), since the goods merely serve to promote and announce the specific event. These goods and services are not complementary.
- *Herbal nutritional supplements* in Class 5, whose main purpose is to prevent or remedy medical problems, in the broad sense of the term, or to balance nutritional deficiencies, are not indispensable or important for the use of *beers, mineral and aerated waters and other non-alcoholic drinks, fruit drinks and fruit juices, syrups and other preparations for making beverages* in Class 32, whose main purpose is to quench thirst or form part of standard human nutrition. Any combined consumption of those products is merely ancillary. Although one of the products can supplement the consumption of the other, these goods are not complementary. Furthermore, since their purpose, distribution channels and usual producers are different, and they are not in competition, these goods are not similar (23/01/2014, [T-221/12](#), Sun fresh, EU:T:2014:25, § 47, 70 and 84).

Lastly, complementarity applies only to the use of goods, not to their production process. Goods cannot be regarded as complementary on the ground that one is used to manufacture the other (09/04/2014, [T-288/12](#), Zytel, EU:T:2014:196; § 39;

25/09/2018, [T-435/17](#), HIPANEMA (fig.) / Ipanema (fig.) et al., EU:T:2018:596; § 71). Even when one product is used to manufacture another, this does not mean that the relevant public will assume they are offered by the same undertaking (06/04/2017, [T-39/16](#), NANA FINK (fig.) / NANA, EU:T:2017:263, § 89). A thorough case-by-case assessment has to be carried out (see specific examples in [Annex I, Specific Questions on the Similarity of Goods and Services, paragraph 4.2](#), and [Annex II, Specific Industries, paragraphs 5.3.1 and 5.4.2](#)).

### 3.2.5 In competition

Goods/services are in competition with each other when one can substitute the other. That means that they serve the same or a similar purpose and are offered to the same actual and potential customers. In such a case, the goods/services are also defined as ‘interchangeable’ (04/02/2013, [T-504/11](#), Dignitude, EU:T:2013:57, § 42).

#### Examples

- *Wallpaper* (Class 27) and *paints* (Class 2) are in competition because both cover or decorate walls.
- *Rental of movies* (Class 41) and *services of a cinema* (Class 41) are in competition because they both allow you to watch a film.
- *Electric shavers* and *razor blades* (both in Class 8) are in competition because they serve the same purpose.

In some cases the price of goods/services in competition may differ significantly, but this fact alone does not affect the analysis of whether they are in competition with each other or not.

#### Example

- *Jewellery made of gold* and *fashion jewellery* <sup>(56)</sup> (both in Class 14) are in competition even though their price (and value) may greatly differ.

### 3.2.6 Distribution channel

Although ‘distribution channel’ is not explicitly mentioned in the *Canon* judgment, it is widely used internationally and nationally in the assessment of whether two goods/services are similar. It has been taken into account as an additional factor in several judgments of EU courts (21/04/2005, [T-164/03](#), monBeBé, EU:T:2005:140, § 53). The reasoning for this is as follows.

If the goods/services are made available through the same distribution channels, the consumer may be more likely to assume that the goods/services are in the same market sector and are possibly manufactured by the same entity and vice versa.

The term ‘distribution channel’ does not refer so much to the way of selling or promoting a company’s product as to the place of distribution. For the analysis of the similarity of goods/services, the distribution system — whether direct or indirect — is

---

<sup>56</sup> Fashion/costume jewellery is understood to be jewellery made from inexpensive metals and imitation gems or semi-precious stones, worn for decorative purposes.

not decisive. The question to be asked is rather: do the goods/services have the same points of sale, or are they usually provided or offered at the same or similar places?

However, too much emphasis should not be placed on this factor as modern supermarkets, drugstores and department stores sell goods of all kinds. The relevant public is aware that the goods sold in these places come from a multitude of independent undertakings. Therefore, the point of sale is less decisive when deciding whether the relevant public considers that goods share a common origin merely because they are sold at the same outlet.

Only where the goods in question are offered in the same **section** of such shops, where homogeneous goods are sold together, will this favour similarity. In such cases it must be possible to identify the section by its territorial and functional separation from other sections (e.g. dairy section of a supermarket, the cosmetics section of a department store).

Similarly, this factor may apply in cases in which goods are sold exclusively or commonly in specialised shops. In that event, consumers may tend to believe the origin of the goods to be the same if they are both sold in the same specialised shops and may tend to deny that mutual origin if they are not usually sold in the same shops.

Conversely, different sales outlets may weigh against the similarity of goods.

#### Example

- *Wheelchairs versus bicycles.*

Although both fall under *vehicles* in Class 12, they will not be found at the same outlets. Bicycles are usually sold either in specialist bicycle stores or in a retail store where sporting equipment is available. By contrast, the distribution channels for *wheelchairs* are the specialised distributors of medical equipment and devices that supply hospitals, and specialised shops where devices for disabled or physically handicapped people are sold.

### 3.2.7 Relevant public

The relevant public, such as the actual and potential customers of the goods and services in dispute, constitutes another factor to be dealt with in the analysis of similarity (see the Guidelines, [Part C, Opposition, Section 2, Double Identity and Likelihood of Confusion, Chapter 3, Relevant Public and Degree of Attention](#)).

The relevant public can be composed of:

- the general public (public at large) or
- a professional public (business customers or specialised public).

The relevant public does not necessarily mean the end user; for instance, the end users of *food for animals* in Class 31 are animals, not the relevant public. The relevant public in this case would be the general consumer.

The mere fact that the potential customers coincide does not automatically constitute an indication of similarity. The same group of customers may be in need of goods/services of the most diverse origin and nature. The fact that, for example, television

sets, cars and books are bought by the same relevant public, namely the public at large, has no impact on the analysis of similarity. In many cases, either one or both lists of goods/services under comparison target the public at large, but the purpose (of covering customers' needs) is different in each case. Such circumstances weigh against similarity.

While a coincidence in the relevant public is not necessarily an indication of similarity, largely diverging publics weigh heavily against similarity.

Diverging customers can be found in the following cases, where:

1. the goods/services of both lists are directed at the public at large, who can, however, be clearly categorised by their different (personal) needs, ages, etc.  
Example: *wheelchairs* versus *bicycles* (Class 12).
2. the goods/services of both lists target business customers, who may, however, be acting in a very different market sector.  
Example: *chemicals used in forestry* versus *solvents for the lacquer industry* (Class 1).
3. one relevant public consists of general consumers and the other of business customers.  
Example: *containers for contact lenses* (in Class 9) versus *surgical apparatus and instruments* (in Class 10).

### 3.2.8 Usual origin (producer/provider)

Although the Court of Justice did not explicitly mention this factor in its *Canon* judgment, it follows from the general concept of likelihood of confusion that the usual origin of the goods and services is of particular importance for the analysis of similarity. As the Court has stated, it is 'the risk that the public might believe that the goods/services in question come from the same undertaking or, as the case may be, from economically linked undertakings, [that] constitutes a likelihood of confusion' (29/09/1998, [C-39/97](#), *Canon*, EU:C:1998:442, § 29). Hence, there is a strong indication of similarity when, in the mind of the relevant public, the goods/services have the same usual origin.

However, this should not be misinterpreted as turning the examination of likelihood of confusion and similarity of goods/services upside down: the finding of a likelihood of confusion depends on many other factors (such as the similarity of signs and the distinctiveness of the earlier mark) and is not exclusively determined by the usual origin, which as such is only one factor in the analysis of the similarity of goods/services.

A finding that consumers will not be confused about the origin of the goods/services is not an argument appropriate to the comparison of goods/services. This finding should be mentioned in the overall assessment of likelihood of confusion. Origin, in this context, relates mainly to the manufacturing sector (industry) or kind of undertaking producing the goods or offering the services in question rather than to the identity of the producer.

The 'origin' is not merely defined by the actual place of production/provision (e.g. factory, workshop, institute or laboratory) but primarily by taking into consideration who manages and/or controls the production/provision of the goods/services. In other words, the question to be asked is: who is responsible for manufacturing the product or providing the service?

The geographical origin (e.g. China) is not relevant for the finding of similarity of goods/services.

The Court has held that even goods and services can have the same origin if it is common for the same type of company to produce/provide both. *Educational textbooks* (Class 16) were considered to have the same origin as *provision of correspondence courses* (Class 41) since 'undertakings offering any kind of course often hand out those products to pupils as support learning materials' (23/10/2002, [T-388/00](#), ELS, EU:T:2002:260, § 55).

The criterion 'usual origin' has to be applied in a restrictive way in order not to dilute it. If all kinds of goods/services deriving from one large (multinational) company or holding were found to have the same origin, this factor would lose its significance.

The relevant public will perceive different goods as having a common commercial source only where a large part of the producers or distributors of the products in question are the same (11/07/2007, [T-150/04](#), Tosca Blu, EU:T:2007:214, § 37; 01/03/2005, [T-169/03](#), Sissi Rossi, EU:T:2005:72, § 63).

Different categories of goods which, as a general rule, are produced by separate, specialist undertakings cannot be considered to have a common commercial source simply because they may be offered by very well-known brands, since those cases are marginal (02/07/2015, [T-657/13](#), ALEX / ALEX et al., EU:T:2015:449, § 87). The mere fact that **some** manufacturers produce two different categories of goods is not sufficient to demonstrate that a large part of the manufacturers or distributors of those goods are the same (23/01/2014, [T-221/12](#), Sun fresh, EU:T:2014:25, § 91).

#### 3.2.8.1 Features defining a common usual origin

When determining the usual origin of a product/service the following features might be relevant.

##### Manufacturing sites

##### Example

- *Varnishes, lacquers, colorants and mordants* (Class 2) are typically produced by the same production enterprises, normally specialised chemical companies.

The place of production can be a strong indicator that the goods/services in question come from the same source. However, while the same manufacturing sites suggest a common usual origin, different manufacturing sites do not exclude that the goods come from the same or economically linked undertakings. For instance, *books* (Class 16) and *electronic media* (Class 9) (goods in competition, with e-media substituting books) are both goods of a publishing house.



### Methods of manufacture

#### Example

- *Leather belts* (Class 25) and *leather handbags* (Class 18) are not only manufactured in the same sites, for example, leather workshops, but are also manufactured using the same tools and machines for the treatment of leather.

### (Technical) know-how

#### Example

- *Computer virus protection services* (Class 42) and *software design* (Class 42) involve similar technical know-how in the field of information technology.

### Established trade custom known to the public

An established trade custom, such as when manufacturers expand their businesses to adjacent markets, is of particular importance for concluding whether goods/services of different nature have the same origin. In such situations, it is necessary to determine whether such expansion is common in the industry or, conversely, whether it may occur in exceptional cases only.

### Example where extension has become customary

- *Shoes* (Class 25) and *handbags* (Class 18): it is customary in the market for the producers of shoes also to be involved in the manufacture of handbags.

### Example where extension is not (yet) common

- *Clothing* (Class 25) and *perfumes* (Class 3): even though some designers that make fashion clothes nowadays also sell perfumes under their marks, this is not the rule in the clothing industry, and rather applies only to (economically) successful designers.
- *Clothing* and *footwear* (Class 25) and *watches* and *jewellery* (Class 14) may be manufactured by certain commercially successful fashion designers, but this is, to date, marginal in the overall assessment of the market sector under consideration. There are significant differences in the nature of these goods, their manufacturing processes and the know-how required for the creation of a quality product in each of the branches in question. Even if successful fashion designers attempt to exploit their success by affixing their trade marks to a wide range of goods, that will not influence the expectations of consumers outside of the luxury sector who will not normally expect that the same undertaking would be responsible for the manufacture of the different goods at issue, which are not at first sight related and do not, in addition, fall within the same family of goods. Hence, those consumers will not deduce that these goods constitute an extended range of goods which come from the same source (12/02/2015, [T-505/12](#), B, EU:T:2015:95, § 71-74).

## **3.3 Relation between different factors**

The Canon criteria were enumerated in the corresponding judgment without any indication of relationship or hierarchy (weight) among them. They were considered one by one. However, they cannot be considered independently since some criteria are

interrelated and some criteria are more important than others, regardless of whether goods are being compared with goods, services with services or goods with services. As a result of weighing all these factors in accordance with their respective importance in relation to the goods/services at issue, similarity may be found to various degrees: low, average or high (see [paragraph 3.3.4](#)).

### 3.3.1 Interrelation of factors

In many cases there will be relationships between the factors in the sense that where one is shared, another one might coincide as well.

#### Examples

- Based on the purpose, it is also possible to determine who the actual and potential customers (i.e. the relevant public) are.
- The purpose, together with the relevant public, may also reveal whether goods/services are in competition.
- The same distribution channel goes hand in hand with the same public. In other words, where the distribution channels are different, the public may be different as well.
- Goods/services intended for different publics cannot be complementary (11/05/2011, [T-74/10](#), Flaco, EU:T:2011:207, § 40, 22/06/2011; [T-76/09](#), Farma Mundi Farmaceuticos Mundi, EU:T:2011:298, § 30).
- The method of use usually depends on the nature and purpose of the goods.

There are cases in which it is difficult to make a distinction between various factors. This is particularly true as far as 'nature', 'purpose' and 'method of use' are concerned. Where the examiner encounters such difficulties, it is sufficient to treat these factors jointly.

#### Example

- An *engine* is a machine for converting any of various forms of energy into mechanical force and motion. In such a case, it is difficult to distinguish the nature from the purpose of the product. Therefore, in this case, no distinction between what is nature and what is purpose is necessary.

### 3.3.2 Importance of each factor

In assessing the similarity of goods and services, **all** relevant factors characterising the relationship between them should be taken into account. However, depending on the kind of goods and services, a particular criterion may be more or less important. In other words, the various criteria do not have a standard value; rather, their specific importance should be determined in the context of each individual case.

In general, the weight of each factor will depend on the impact it has on possible confusion regarding origin. Criteria clearly suggesting that the goods/services come or do not come from the same undertaking or economically linked undertakings should take precedence.



### Generally strong factors

- Usual origin (because it has a strong impact on likelihood of confusion, which relates to common commercial origin).
- Purpose (because it is decisive for the choice made by the customer buying or selecting goods/services).
- Nature (because it defines the essential qualities and characteristics of the goods/services).
- Complementarity (because the close connection between the use of the goods/services makes the public believe that they share the same source).
- In competition (usually goods/services that are in competition have the same purpose and target the same public).

### Less important factors

- Method of use (even dissimilar goods can be used in the same manner, e.g. *baby carriages* and *shopping trolleys*).
- Distribution channels (even dissimilar goods can be sold in the same section of stores depending on different display practices, e.g. *chewing gum* (Class 30) and *cigarettes* (Class 34)).
- Relevant public.

#### 3.3.3 Different types of comparisons: goods versus goods, services versus services and goods versus services

In principle, the same factors for comparing goods with goods are relevant for the comparison of services with services. However, in applying these factors, the basic difference between goods and services (tangible versus intangible) must be considered.

Furthermore, the same principles that apply for the comparison between goods and goods and between services and services also apply in cases where goods are compared with services.

By their nature, goods are generally dissimilar to services. They can, however, be complementary. Services can also have the same purpose and thus be in competition with goods. It follows that under certain circumstances similarity between goods and services can be found.

#### 3.3.4 Degree of similarity

Goods/services can be found similar to different degrees (low, average or high), depending on how many factors they share and the weight given to each of them. The degree of similarity found between the goods and services is of relevance when making a final decision on the likelihood of confusion.

Generally, one factor on its own is not sufficient for finding similarity between the goods/services, even if it is a strong factor.

### Examples of dissimilarity

- *Cars* and *bicycles* (both in Class 12) share the same purpose (taking oneself from A to B), but this does not make them similar.
- Although *window glass* (Class 19) and *glasses for spectacles* (Class 9) have the same nature, they are not similar, since they do not coincide in other relevant factors, such as purpose, producers, distribution channels and relevant public.

It is the combination of various factors and their weight that allows the final conclusion on similarity. The combination of two strong factors, such as nature and producer, or the combination of one strong and two weak factors will often lead to similarity. In contrast, the combination of two weak factors, such as distribution channel and relevant public are, in principle, not conclusive for a finding of similarity between the goods and services.

#### Examples of similarity

- *Milk* and *cheese* (both in Class 29) have a different purpose and method of use; they are not in competition or complementary. However, the fact that they share the same nature (dairy goods) and usual origin (dairy company) is decisive for a finding of similarity.
- Although *pharmaceuticals* and *plasters* (both in Class 5) have a different nature, they share a similar purpose: treating diseases, disabilities or injuries. Furthermore, they have the same distribution channels and relevant public. Therefore, they are similar.

The number of coinciding factors found, together with their importance/weight, establishes the degree of similarity. Generally speaking, the higher the number of common factors, the higher the degree of similarity. A similarity found on the basis of only two factors would normally not be high, unlike in cases where the goods/services coincide in four or more relevant factors.

However, no mathematical analysis is possible since it always depends on the specific circumstances of each case.

## 4 Annex I: Specific Questions on the Similarity of Goods and Services

This part does not establish any new criteria for finding similarity between goods and services. It merely helps to clarify how to compare specific groups of goods and services for which, apart from the Canon criteria, some general rules and exceptions apply.

### 4.1 Parts, Components and Fittings

The mere fact that a certain product can be composed of several components does not automatically establish similarity between the finished product and its parts (27/10/2005, [T-336/03](#), Mobilix, EU:T:2005:379, § 61).

#### Examples of dissimilarity

- *Fan blades* (Class 7) and *hair dryer* (Class 11)
- *Electric cable* (Class 9) and *lamp* (Class 11)
- *Balls for ball-point pens* (Class 16) and *ball-point pens* (Class 16)
- *Buttons* (Class 26) and *clothing* (Class 25).

Similarity will be found where at least some of the main factors for finding similarity (such as producer, public and/or complementarity) are present, taking into account the relationship between the factors and the importance of each factor for assessing similarity (see [paragraph 3.3](#)).

Such similarity is based on the fact that parts and fittings are often produced and/or sold by the same undertaking that manufactures the end product and target the same purchasing public, as in the case of spare or replacement parts which are also sold independently of the final product. Furthermore, there is complementarity between the goods in question when the respective part/component/fitting is required for proper use of the final product and/or when the part/component/fitting cannot serve its intended purpose if it is not included in the final product. In that case, the public may also expect part/component/fitting to be produced by, or under the control of, the 'original' manufacturer, which would also suggest that the goods were similar.

#### Examples of similarity

- *Electric toothbrush* (Class 21) and *replacement brush heads* (Class 21)
- *Printer* (Class 9) and *ink jet cartridges* (Class 2)
- *Sewing machines* (Class 7) and *walking feet for sewing machines* (Class 7).

### 4.2 Raw Materials and Semi-Processed Goods

In most cases, the mere fact that one product is used for the manufacture of another will not be sufficient in itself to show that the goods are similar, as their nature, purpose, relevant public and distribution channels may be quite distinct (13/04/2011, [T-98/09](#), T

Tumesa Tubos del Mediterráneo S.A., EU:T:2011:167, § 49-51). According to case-law, the raw materials subjected to a transformation process are essentially different from the finished products that incorporate, or are covered by, those raw materials, in terms of nature, aim and intended purpose (03/05/2012, [T-270/10](#), Karra, EU:T:2012:212, § 53).

Furthermore, they are not complementary on the ground that one is manufactured with the other, and raw material is in general intended for use in industry rather than for direct purchase by the final consumer. In that regard, *plastic or synthetic products used as raw or semi-finished material* (in Classes 1 and 17) cannot be regarded as complementary to *finished products* (made from these materials in Classes 9 and 12) on the ground that the raw materials are intended to be turned into finished products (09/04/2014, [T-288/12](#), Zytel, EU:T:2014:196, § 39-43).

#### Examples of dissimilarity

- *Leather, animal skins* (Class 18) and *clothing* (Class 25)
- *Precious metals* (Class 14) and *jewellery* (Class 14).

However, the final conclusion may depend on the specific circumstances of the case, such as the degree of transformation of the raw material and whether it can be obtained separately from the end product through the same distribution channels.

#### Example of similarity

- *Precious stones* (Class 14) and *jewellery* (Class 14). Contrary to *precious metals*, *precious stones* can be obtained in jewellery shops independently of the end product.

See also [Annex II, paragraph 5.4.2, 'Ingredients of prepared food'](#).

### **4.3 Accessories**

'Accessories' with no further qualification is an unclear or imprecise term as described in [paragraph 1.5.2 'The relevant scope'](#), and should be treated accordingly.

An accessory is something extra that improves or completes the main product it is added to, and usually fulfils a decorative purpose. Unlike parts, components and fittings, an accessory, while usually used in close connection with the main product, does not constitute an integral part of it.

The mere fact that a certain product is used in combination with another is not necessarily conclusive for a finding of similarity (see, for example, 'aesthetic complementarity', [paragraph 3.2.4](#)).

#### Examples of dissimilarity

- *Clothing* (Class 25) and *hair ornaments* (Class 26)

However, it is common for some accessories also to be produced by the manufacturer of the main product. Consequently the consumer may expect the main product and accessories to be produced under the control of the same entity, especially when they

are distributed through the same channels of trade. In such cases, there is a strong indication of similarity.

#### Examples of similarity

- *Bicycles* (Class 12) and *panniers for bicycles* (Class 12)
- *Glasses* (Class 9) and *cases for glasses* (Class 9).

## 4.4 Installation, Maintenance and Repair Services

These services belong to the category of goods-related services.

Since, by nature, goods and services are dissimilar, similarity between goods and their installation, maintenance and repair can only be established when:

- it is common in the relevant market sector for the manufacturer of the goods to also provide such services; **and**
- the relevant public coincides; **and**
- installation, maintenance and repair of these goods are provided independently of the purchase of the goods (not aftersales services).

The installation of virtually all goods is classified in Class 37, such as *installation of air conditioning apparatus, consumer electric appliances, elevators or lifts, fire alarms, freezing machines, kitchen appliances*. The *installation and repair of computer hardware* is also in Class 37, as it is a physical repair and installation activity. However, *installation and repair of computer software* is classified in Class 42 because it involves computer programming without any physical installation or repair.

#### Examples of similarity

- *Data processing equipment and computers* (Class 9) and *installation and repair of computer hardware* (Class 37)
- *Air conditioning apparatus* (Class 11) and *installation, maintenance and repair of air conditioning apparatus* (Class 37)
- *Machinery for working metal* (Class 7) and *maintenance of machinery* (Class 37).

#### Examples of dissimilarity

- *Building materials* (Class 19) and *installation of building insulation* (Class 37)
- *Shoes* (Class 25) and *repair of shoes* (Class 37)
- *Vehicles* (Class 12) and *dent removal for motor vehicles* (Class 37) (15/12/2010, [T-451/09](#), Wind, EU:T:2010:522, § 28-30).

## 4.5 Advisory, Consultancy and Information Services

*Advisory services* refer to providing advice that is tailored to the circumstances or needs of a particular user and that recommends specific courses of action for the user. *Provision of information*, however, refers to providing a user with materials (general or specific) about a matter or service but not advising the user on specific courses of action. With the 8th edition of the Nice Classification, *professional consultation services*

in Class 42 were eliminated. Since then consultation services — as well as *advisory and information services* — have been classified in the class of the service that corresponds to the subject matter of the consultation. For instance, *transportation consultancy* belongs to Class 39, *business management consultancy* falls under Class 35, *financial consultancy* is classified in Class 36 and *beauty consultancy* in Class 44. The rendering of the advice, information or consultancy by electronic means (e.g. telephone, computer) does not affect the classification of these services.

Advisory, consultancy and information services are covered by the services to which they relate, insofar as they are an inherent part thereof.

However, if the advisory, consultancy or information services are not provided by the same undertaking, they may only be similar if they are complementary and target the same public through the same channels of distribution, and may even be dissimilar if they do not share any relevant factors.

#### Examples

- Financial information services (Class 36) are included in *financial affairs* (Class 36) and are thus identical (27/02/2008, [T-325/04](#), Worldlink, EU:T:2008:51, § 58).
- Computer software advisory services (Class 42) are similar to the installation and maintenance of software (Class 42) because, although they may not necessarily be included in installation and maintenance of software, they are often complementary.

When it comes to comparing advisory, consultancy and information services with goods, similarity can be found under conditions akin to those concerning maintenance, installation and repair (see [paragraph 4.4](#)).

#### Examples of similarity

- *Advisory services in computer technologies (hardware and software)* (Class 42) and *computer software* (Class 9)
- *Beauty consultancy* (Class 44) and *cosmetics* (Class 3).

#### Examples of dissimilarity

- *Information services concerning the purchase of fashion articles (shoppers guide information)* (Class 35) and *clothing, footwear and headgear* (Class 25), as it is not common in the market for the manufacturer of articles in Class 25 to provide such information services to consumers.
- *Providing information in the field of entertainment* (Class 41) and *toys* (Class 28), as it is not common in the market for the manufacturer of toys in Class 28 to provide such information services to consumers.

## 4.6 Rental and Leasing

**Rental services** are classified in the same classes as the service provided by means of the rented objects:

- *rental of telephones* is in Class 38 because *telecommunication services* are in Class 38;

- *rental of cars* is in Class 39 because *transport services* are in this class.

**Leasing services** are analogous to rental services and therefore are classified in the same way. However, hire- or lease-purchase financing is classified in Class 36 as a financial service.

Based on the understanding that *leasing* in English means rental, these services must be clearly distinguished from any financial services. The comparison of rental and leasing services leads to the outcomes shown in the following paragraphs.

#### 4.6.1 Rental/leasing versus related services

Even though rental services are classified in the same classes as the service provided by means of the rented objects, they are not automatically identical to this service. The comparison between these services has to be made applying normal criteria for identity and similarity.

##### Examples

- There is identity between *rental of flats* (Class 36) and *real estate affairs* (Class 36) because *rental of flats* is included in *real estate affairs*.
- The same reasoning cannot apply to *rental of bulldozers* (Class 37) and the related services of *building construction* (Class 37). *Rental of bulldozers* is not included in *building construction* and therefore these services are not considered to be identical.

#### 4.6.2 Rental/leasing versus goods

Rental/leasing services are in principle always dissimilar to the goods rented/leased.

##### Examples

- *Vehicle rental* (Class 39) and *vehicles* (Class 12)
- *Rental of films* (Class 41) and *DVDs* (Class 9).

Exceptions exist where it is common for the manufacturer of the goods to provide rental services.

- *Rental and leasing of computer software* (Class 42) and *computer software* (Class 9) are considered to be similar.
- *Rental of automatic vending machines* (Class 35) and *automatic vending machines* (Class 7) are considered to be similar.

### 4.7 Examples of unclear and imprecise terms

General indications of class headings, from current and previous editions of the Nice Classification (the part shown in bold is the part which is seen as unclear and imprecise):

Class 6: **Goods of common metal not included in other classes**

Class 7: **Machines** and machine tools

Class 14: *Precious metals and their alloys and **goods in precious metals or coated therewith**, not included in other classes*

Class 16: *Paper, cardboard and **goods made from these materials [paper and cardboard]**, not included in other classes*

Class 17: *Rubber, gutta-percha, gum, asbestos, mica and **goods made from these materials [rubber, gutta-percha, gum, asbestos and mica]** and not included in other classes*

Class 18: *Leather and imitations of leather, and **goods made of these materials [leather and imitations of leather]** and not included in other classes*

Class 20: **Goods (not included in other classes) of wood, cork, reed, cane, wicker, horn, bone, ivory, whalebone, shell, amber, mother-of-pearl, meerschaum and substitutes for all these materials, or of plastics**

Class 37: **Repair**

Class 37: **Installation services**

Class 40: **Treatment of materials**

Class 45: **Personal and social services rendered by others to meet the needs of individuals.**

For other terms lacking clarity and precision, see also The Guidelines, [Part B, Examination, Section 3, Classification, paragraphs 4.3.1](#) and [4.3.2](#).



## 5 Annex II: Specific Industries

### 5.1 Chemicals, Pharmaceuticals and Cosmetics

#### 5.1.1 Chemicals (Class 1) versus chemical products (Classes 3 and 5)

Although major chemical companies are usually involved in the production of all kinds of basic chemicals, speciality chemicals and life science products, including pharmaceuticals and pesticides, as well as consumer products, such as cleaning preparations and cosmetics, the mere fact that their nature coincides — as all of them can be broadly classified as chemical products — is not sufficient to find them similar. Special attention must be drawn to the specific purpose of these chemicals, as well as to their public and distribution channel. What has been said in [paragraph 4.2](#) as to the relation between raw materials, semi-processed and finished products particularly applies to these products.

Consequently, although goods in Class 3 and Class 5 are usually combinations of various chemicals, they are in principle not considered similar to goods included in Class 1. Their purpose as a finished product usually differs from goods in Class 1, which are mainly in their raw, unfinished state and not yet mixed with other chemicals and inert carriers into a final product. The finished products in Class 3 and Class 5 usually also target a different public and do not share the same distribution channels.

However, it cannot be excluded that some chemicals (e.g. *chemicals used in agriculture, horticulture and forestry*) require few processing steps to be considered finished products (e.g. *fungicides*). Such chemicals may be considered to already share the inherent purpose of the finished goods. Furthermore, the same chemical companies may produce both semi-processed goods and the final product. Therefore, in such cases a degree of similarity may be found.

Furthermore, there are also goods in Class 1 that are not mere chemicals but are semi-finished or even finished products with a specific purpose of use, which is an important factor that must be taken into account when comparing goods in Class 1 with goods in other classes.

#### 5.1.2 Pharmaceuticals versus pharmaceuticals

Specific pharmaceuticals are considered to be similar to other specific pharmaceuticals. This is because several, if not all, criteria for similarity are usually met: they share the same nature because they are specific chemical products; their purpose is, broadly speaking, healing and/or curing; they are sold in the same places, namely, pharmacies; and they come from the same source, which is the pharmaceutical industry. This industry manufactures a wide variety of drugs with various therapeutic indications, something the general public is aware of. Furthermore, their method of use can be the same and they can be in competition with one another

(17/11/2005, [T-154/03](#), Alrex, EU:T:2005:401, § 48). However, the degree of similarity found between specific pharmaceuticals may vary depending on their specific therapeutic indications.

Whether a specific pharmaceutical is sold under prescription is not particularly relevant when comparing the goods. Therefore, a prescription medicine is generally to be considered similar to an over-the-counter drug for the reasons stated above.

### 5.1.3 Pharmaceuticals versus cosmetics

The general categories *pharmaceuticals* and *cosmetics* are considered to be similar. Cosmetics include preparations used to enhance or protect the appearance or odour of the human body and they are also often fragranced to add a pleasant smell. Pharmaceuticals, however, comprise products, such as skin or haircare preparations with medical properties. They may coincide in purpose with cosmetics. Moreover, they share the same distribution channels since they can be found in pharmacies or other specialised shops. They target the same public and are often manufactured by the same companies.

However, when comparing specific pharmaceuticals with cosmetics, they might only have a low degree of similarity or they might even be entirely dissimilar, depending on the specific drug or specific cosmetic product, their specific purpose (medical indication/cosmetic application) or their method of use.

## 5.2 Automobile Industry

The automobile industry is a complex industry involving various kinds of companies, including car manufacturing companies as well as any suppliers that provide the car manufacturer with their raw materials (metal, aluminium, plastics, paints, etc.), parts, modules or complete systems. Several areas of production can be distinguished: drive engineering, chassis, electronics, interior and exterior.

The complexity of the industry and the fact that the final product incorporates some component parts and accessories complicate the examination of similarity between the end product (e.g. a car) and the various parts or materials used for its production. Furthermore, when purchasing a car, the general public knows that a car incorporates many items from many sources and that the car manufacturer might assemble components that have been manufactured by others. However, as far as the consumer of a car is concerned, the goods are normally offered under only one sign, which makes it almost impossible for the general public to identify other manufacturers or to differentiate their source of production. Exceptions include car batteries or tyres, where other signs are usually visible.

As with other industries, the Canon criteria accordingly apply and in particular the general principles set out for the comparison of parts, components, and fittings have to be taken into consideration.

In particular, it should be kept in mind that there are goods that will only be purchased by the automobile industry without any possibility of them ever reaching or being purchased by the general public (end consumer). One example is the common metal (Class 6) used to form the chassis. Such goods are clearly dissimilar to the car and probably dissimilar to all other parts, components and fittings. However, there are spare parts that might also be purchased by the general public for repair or maintenance purposes. Assessment of the similarity of these goods will mainly depend on whether the specific spare part is commonly produced by the car manufacturer.

### 5.3 Fashion and Textile Industries

Goods classified in Classes 22, 23, 24 and 25 are textile related. There is a certain progression through these classes: *raw fibrous textile materials*, such as *fibres* (Class 22), are further made into *yarns and threads* (Class 23), then into *textiles*, such as *fabrics* (Class 24), and end up as *finished goods made of textile* (Class 24) or *clothing* (Class 25).

Moreover, Class 18 goods that are made of leather and/or imitations of leather may be related to the fashion and textile industries.

#### 5.3.1 Raw or semi-processed materials versus finished goods

Since the relationship between Classes 22, 23, 24 and 25 is often based on the fact that one product is used for the manufacture of another (e.g. *textiles* in Class 24 are used for the manufacture of *clothing* in Class 25), in comparisons of this kind, general rules concerning raw materials apply (see [Annex I, paragraph 4.2](#)).

However, a degree of similarity may be found between *textiles* and specific *textile goods*, such as *bed sheets* and *table covers*, in Class 24. In such cases, the degree of transformation required from material to end product is insignificant – the fabric is merely cut into shape and/or sewn to obtain the finished product. Furthermore, many establishments allow customers to purchase the base material or ready-made products made from such material. Therefore, the relevant public may expect these goods to come from the same undertakings.

#### 5.3.2 Textile goods (Class 24) versus clothing (Class 25)

When comparing *textile goods* in Class 24 with *clothing* in Class 25 it has to be considered that most items covered by *textile goods* in Class 24 are dissimilar to most items of *clothing* in Class 25 (for example *bed linen* in Class 24 and *skirts* in Class 25). The main commonality between them is that they are all made of textile, however they serve, in principle, completely different purposes: items of clothing are meant to be worn by people, or serve as fashion articles, whereas diverse textile goods are mainly for household purposes and interior decoration. Therefore, their method of use is different. Moreover, the distribution channels and sales outlets are different, and the relevant public will not think that they originate from the same undertaking.

However, some specific textile goods may be found similar to specific items of clothing. For example, *bath towels* in Class 24 and *bathrobes* in Class 25 are similar because these both sets of goods aim to absorb moisture from wet skin, they have a similar nature, purpose and are in competition. Additionally, the producers, distribution channels and end users may be the same (12/07/2019, [T-54/18](#), 1st AMERICAN (fig.) / DEVICE OF A BIRD (fig.), EU:T:2019:518, § 72 and 73; 09/09/2020, [T-50/19](#), Dayaday (fig.) / DAYADAY (fig.) et al, ECLI:EU:T:2020:407, § 128).

In view of the fact that *bathrobes* are included in the broad category of *clothing* (09/09/2020, [T-50/19](#), Dayaday (fig.) / DAYADAY (fig.) et al, ECLI:EU:T:2020:407, § 128) and *bath towels* are included in the broad category of *textile goods*, similarity must also be found between the broad categories of *textile goods* in Class 24 and *clothing* in Class 25.

Other specific textile goods may also be found similar to specific items of clothing if the same or similar circumstances apply to those specific goods; this needs to be assessed on a case-by-case basis.

### 5.3.3 Fashion accessories

As explained in the paragraph on ‘Accessories’ (see [Annex I, paragraph 4.3](#)), the mere fact that a certain product is used in combination with another is not necessarily conclusive for a finding of similarity.

However, in the fashion industry, the fact that some fashion accessories may be aesthetically coordinated with some articles of clothing, footwear and headgear should be taken into account (see [paragraph 3.2.4.3](#) on the impact of aesthetic complementarity). Moreover, where it is common for the manufacturer of the main product to produce some accessories, so that consumers might expect them to come from the same entity, and they are distributed through the same trade channels, there is a strong indication for similarity.

## 5.4 Food, Beverages and Restaurant Services

### 5.4.1 Foodstuffs

The fact that goods can be categorised as foodstuffs is insufficient, in itself, to render them similar. The foodstuff industry encompasses goods having very different natures (e.g. foodstuffs of animal origin, foodstuffs of plant origin) that are conceived to be eaten on different occasions and for different purposes (e.g. as seasonings, as sweeteners or as ready meals). Furthermore, specific foodstuff products might be manufactured by different undertakings specialised in a certain field of the foodstuff industry requiring specific production facilities and know-how. Moreover, the fact that foodstuff products are sold in supermarkets, or in the foodstuff sections of department stores, is not conclusive, per se. This is because the relevant public is aware that the goods sold in these places can come from a multitude of independent undertakings.

A case-by-case assessment is therefore required as to whether relevant similarity factors apply when comparing specific foodstuffs.

#### 5.4.2 Ingredients of prepared food

Ingredients used for preparing foodstuffs are a subcategory of raw materials and treated in the same way as raw materials in general (see [Annex I, paragraph 4.2](#)). Consequently, the mere fact that one ingredient is needed for preparing a foodstuff will generally not be sufficient in itself to show that the goods are similar, even though they all fall under the general category of foodstuffs (26/10/2011, [T-72/10](#), Naty's, EU:T:2011:635, § 35-36).

When the ingredient can be considered as the main ingredient of a prepared dish, a similarity will exist only if the goods share some other relevant criterion or criteria, in particular the usual origin, nature, purpose or method of use. For instance, in the *Apetito* judgment (04/05/2011, [T-129/09](#), *Apetito*, EU:T:2011:193), the Court confirms the finding of similarity between a particular foodstuff and prepared meals **mainly** consisting of the same particular foodstuff.

However, there is no complementarity simply because one ingredient is needed for producing/preparing another foodstuff. Complementarity applies only to the use of goods and not to their production process (see [paragraph 3.2.4](#) and 11/05/2011, [T-74/10](#), *Flaco*, EU:T:2011:207, § 40; 11/12/2012, [R 2571/2011-2](#), *Fruitini*, § 18).

#### 5.4.3 Non-alcoholic beverages (Class 32) versus alcoholic beverages (except beers) (Class 33)

The Court found that a very large number of alcoholic and non-alcoholic drinks are generally mixed, consumed, or indeed marketed together, either in the same establishments or as premixed alcoholic drinks (04/10/2018, [T-150/17](#), *FLÜGEL / ... VERLEIHT FLÜGEL et al.*, EU:T:2018:641, § 77-84). To consider that those goods should, for that reason alone, be described as similar, when they are not intended to be consumed in either the same circumstances, or in the same state of mind, or, as the case may be, by the same consumers, would put a large number of goods that can be described as 'drinks' into one and the same category for the purposes of the application of [Article 8\(1\) EUTMR](#).

Thus, it cannot be considered that an alcoholic drink and an energy drink are similar merely because they can be mixed, consumed or marketed together, given that the nature, intended purpose and use of these goods differ based on the presence of, or absence of alcohol in their composition. Furthermore, it must be held that the undertakings that market alcoholic drinks premixed with a non-alcoholic ingredient do not sell that ingredient separately and under the same or a similar mark as the premixed alcoholic drink at issue.

Therefore, most non-alcoholic drinks in Class 32 are considered to be dissimilar to most alcoholic drinks in Class 33 (22/09/2021, [T-195/20](#), *chic ÁGUA ALCALINA 9,5 PH (fig.) / Chic Barcelona et al.*, EU:T:2021:601, in which *bottled drinking water; mineral*

*water (non-medicated); mineral water (beverages)* were found dissimilar to *alcoholic beverages (except beers); wine; sparkling wines; liqueurs; spirits (beverages); brandies*; 21/01/2019, [R 1720/2017-G](#), ICEBERG (fig.) / ICEBERG et al., in which, for example, *mineral water, soft drinks and fruit juices* were found to be dissimilar to *vodka*).

However, some specific non-alcoholic drinks may be similar to some specific alcoholic drinks. For example, *alcohol free wine* and *de-alcoholised wine* in Class 32 and *wine* in Class 33. There is a growing trend in the drinks market sector for winemaking companies to also produce and offer non-alcoholic wine as an alternative to alcoholic wine. Indeed, non-alcoholic wine often goes through the same fermentation and ageing process as alcoholic wine, only to have the alcohol removed at the last stages (either through distillation or filtration). Furthermore, non-alcoholic wine is intended to be consumed in the same circumstances as alcoholic wine by consumers who cannot, or choose not to, consume alcohol. Since consumers will perceive them as alternative products they must also be considered to be in competition. In addition, it is not uncommon for non-alcoholic wine to be sold in wine shops or specialised wine sections in supermarkets. It follows that *non-alcoholic wine* is similar to *wine*. As a result, similarity must also be found between the broader categories of *non-alcoholic beverages* in Class 32 and *alcoholic beverages (except beers)* in Class 33, which include those specific goods respectively. The same conclusion was reached in Grand Board of Appeal decision of 13/04/2022, [R 964/2020-G](#), Zoraya / Viña zoraya - similarity was found between *non-alcoholic beverages* and *wine* because of the similarity between *non-alcoholic wine* and *wine* and considering that *non-alcoholic beverages* include *non-alcoholic wine*.

Other specific non-alcoholic drinks may be found similar to specific alcoholic drinks if the same or similar circumstances apply to those specific goods. Indeed, the trend in the beverages industry indicates that consumers are increasingly offered the choice between beverages that contain alcohol or not, but otherwise have the same characteristics, especially taste, e.g. *spirits* and *non-alcoholic spirits* (13/04/2022, [R 964/2020-G](#), Zoraya / Viña zoraya, § 70-71, 82-84). Similarity between specific alcoholic beverages and non-alcoholic beverages must be assessed on a case-by-case basis.

#### 5.4.4 Provision of food and drinks versus food and drinks

The provision of food and drinks in Class 43 mainly covers services of a restaurant or similar services, such as catering, cafeterias and snack bars. These services are intended for serving food and drinks directly for consumption.

The Court has consistently found that foodstuffs and drinks, on the one hand, and services for providing food and drink, on the other hand, are, in general, at least similar to a low degree. (For Class 29: 08/12/2021, T-556/19, GRILLOUMI / XΑΛΛΟΥΜΙ HALLOUMI, EU:T:2021:864, § 42-45; 08/12/2021, [T-593/19](#), Grilloumi Burger / Halloumi et al., EU:T:2021:865, § 56-59; 21/04/2021, [T-555/19](#), Grilloumi / Halloumi, EU:T:2021:204, § 45; 12/12/2014, [T-405/13](#), da rosa, EU:T:2014:1072, § 96-97;



13/04/2011, [T-345/09](#), Puerta de Labastida, EU:T:2011:173, § 52. For Classes 30 and 32: 04/06/2015, [T-562/14](#), YOO / YO, EU:T:2015:363, § 25- 28. For Classes 29, 30, 32 and 33: 18/02/2016, [T-711/13](#) & [T-716/13](#), HARRY'S BAR / PUB CASINO Harrys RESTAURANG (fig.) et al., EU:T:2016:82, § 58-60, 65, 69-71, 74-75. For Class 32: 01/03/2018, [T-438/16](#), CIPRIANI / HOTEL CIPRIANI et al., EU:T:2018:110, § 50, 52, 60-61; 17/03/2015, [T-611/11](#), Manea Spa, EU:T:2015:152, § 47, 50-52; 04/11/2008, [T-161/07](#), Coyote ugly, EU:T:2008:473, § 30-33. For Class 30: 01/12/2021, [T-467/20](#), ZARA / ZARA (fig.) et al., EU:T:2021:842, § 127-128, 131-132; 26/04/2018, [T-288/16](#), M'Cooky / MR. COOK (fig.), EU:T:2018:231, § 48).

In a series of cases over a significant period of time, the Court generally acknowledges a complementarity between different foodstuffs and drinks and services for providing food and drink because those foodstuffs and drinks are necessary for the provision of the respective services. Taking into account market practices, it also considers that different foodstuffs and drinks may be sold in the same establishments where the services of providing food and drink are provided, or vice versa. Moreover, certain foodstuffs and drinks may be produced by the same or economically-linked undertakings that also provide services for providing food and drink, or vice versa. Therefore, the relevant public may believe that the same or economically linked undertakings are responsible for them. The Office's practice, therefore, is that a low degree of similarity can generally be found between different foodstuffs and drinks, on the one hand, and services for providing food and drinks, on the other hand. However, in principle, such similarity is unlikely to be established when the provision of food and drinks is compared to mere basic cooking ingredients which are not consumed as such, for example, *baking powder* and *thickening agents for use in cooking*.

## 5.5 Services to Support Other Businesses

The services to support other businesses contained in Class 35 encompass a variety of different services. To establish whether there are relevant common points between them, it is important to establish a common understanding of what those services are and what purpose they serve.

All services listed in the class heading of Class 35 are aimed at supporting or helping other businesses to do or improve business. They are therefore in principle directed at the professional public.

**Advertising services** consist of providing others with assistance in the sale of their goods and services by promoting their launch and/or sale, or of reinforcing the client's position in the market and enabling them to acquire a competitive advantage through publicity. In order to fulfil this target, many different means and products might be used. These services are provided by advertising companies, which study their client's needs, provide all the necessary information and advice for the marketing of their products and services, and create a personalised strategy regarding the advertising of their goods and services through newspapers, websites, videos, the internet, etc.

Examples of advertising services are *rental of advertising time on communication media, telemarketing services, marketing, public relations* and *demonstration of goods*, since they are all intended to promote other companies' goods/services, albeit via different means.

The nature and purpose of advertising services are fundamentally different from the manufacture of goods or from the provision of many other services. Therefore, advertising is generally dissimilar to the goods/services being advertised. The same applies to the comparison of advertising services with goods that can be used as a medium for disseminating advertising, such as DVDs, software, printed matter, flyers and catalogues.

**Management services** are in Class 35 when they relate to the business aspects of an entity. As there are management services in other classes, a management service in Class 35 is taken to relate to business purposes.

**Business management services** are intended to help companies manage their business by setting out the strategy and/or direction of the company. They involve activities associated with running a company, such as controlling, leading, monitoring, organising, and planning. They are usually rendered by companies specialised in this specific field such as business consultants. They gather information and provide tools and expertise to enable their customers to carry out their business or to provide businesses with the necessary support to acquire, develop and expand their market share.

Examples of business management are business research and appraisals, cost-price analyses and organisation consultancy, since they are all intended to help with the strategy of a commercial undertaking. These services also include any 'consultancy', 'advisory' and 'assistance' activity that may be useful in the management of a business, such as how to efficiently allocate financial and human resources, improve productivity, increase market share, deal with competitors, reduce tax bills, develop new products, communicate with the public, carry out marketing, research consumer trends, and launch new products; how to create a corporate identity, etc.

#### Examples

*Business research* is the analysis and interpretation of economic information, such as income, employment, taxes, and demographics. This research information is used by entrepreneurs for making business decisions such as establishing marketing strategies.

*Business appraisals* involve an investigation into the nature and potential of a business and an assessment of its performance in relation to its competitors.

A *cost-price analysis* is a combination of both an evaluation of the proposed total price of a project and the cost of the separate elements of that project (e.g. labour, materials) to determine if they are permissible, related to the project requirements and reasonable. It is used to determine whether going ahead with a project is a sound business decision. It is therefore considered as a service that helps with the management of the business affairs or commercial functions of an industrial or commercial enterprise. Using the information gained from a cost-price analysis, a



business may then go on to make the financial decisions associated with engaging in the project.

When comparing *business management* with *advertising* it should be noted that advertising is an essential tool in business management because it makes the business itself known in the market. As stated above, the purpose of advertising services is 'to reinforce the [business] position in the market' and the purpose of business management services is to help a business in 'acquiring, developing and expanding market share'. There is not a clear-cut difference between 'reinforcing a business position in the market' and 'helping a business to develop and expand market share'. A professional who offers advice about how to efficiently run a business may reasonably include advertising strategies in that advice because there is little doubt that advertising plays an essential role in business management. Furthermore, business consultants may offer advertising (and marketing) consultancy as a part of their services, and therefore the relevant public may believe that these two services have the same professional origin. Therefore, there is a degree of similarity between them.

**Business administration** services are intended to help companies with the performance of business operations and, therefore, the interpretation and implementation of the policy set by an organisation's board of directors. These services consist of organising people and resources efficiently so as to direct activities toward common goals and objectives. They include activities such as personnel recruitment, payroll preparation, drawing up account statements and tax preparation, since these enable a business to perform its business functions and are usually carried out by an entity that is separate from the business in question. They are rendered by, inter alia, employment agencies, auditors and outsourcing companies.

Example

*Business auditing* involves the evaluation of a variety of business activities. It encompasses a review of organisational structures, management, processes, etc.

When comparing *business administration* to *advertising* it should be noted that these services are usually dissimilar, since a professional who helps with the execution of business decisions or the performance of business operations will not offer advertising strategies.

The line between *business management* and *business administration* is blurred, and it is sometimes very difficult to clearly distinguish between them. They both fall under the broader category of business services. As a general rule, it can be said that business administration services are performed in order to organise and run a business, whereas business management follows a higher approach aimed at setting the common goals and the strategic plan for a commercial enterprise.

**Office functions** are the internal day-to-day operations of an organisation, including the administration and support services in the 'back office'. They mainly cover activities that assist in the operation of a commercial enterprise. They include activities typical of secretarial services, such as shorthand and typing, compilation of information in computer databases, invoicing, and administrative processing of purchase orders, as well as support services, such as the rental of office machines and equipment.

## Example

*Book-keeping* is the act of recording financial transactions.

## 5.6 Retail Services

Retail is commonly defined as the action or business of selling goods or commodities in relatively small quantities for use or consumption rather than for resale (as opposed to wholesale, which is the sale of commodities in quantity, usually for resale).

However, it should be noted that the sale of goods is not a service within the meaning of the Nice Classification. Therefore, the activity of retail in goods as a service for which protection of an EUTM can be obtained does not consist of the mere act of selling the goods, but in the services rendered around the actual sale of the goods, which are defined in the explanatory note to Class 35 of the Nice Classification by the terms ‘the bringing together, for the benefit of others, of a variety of goods (excluding the transport thereof), enabling customers to conveniently view and purchase those goods’.

Moreover, the Court has held that the objective of retail trade is the sale of goods to consumers, which includes, in addition to the legal sales transaction, all activity carried out by the trader for the purpose of encouraging the conclusion of such a transaction. That activity consists, inter alia, in selecting an assortment of goods offered for sale and in offering a variety of services aimed at inducing the consumer to conclude the abovementioned transaction with the trader in question rather than with a competitor (07/07/2005, [C-418/02](#), Praktiker, EU:C:2005:425, § 34).

Retail services allow consumers to satisfy different shopping needs in one place and are usually directed at the general consumer. They can take place in a fixed location, such as a department store, supermarket, boutique or kiosk, or in the form of non-shop retailing, such as through the internet, by catalogue or mail order.

The following principles apply as regards the similarity of the goods/services at issue.

### 5.6.1 Retail services versus any good

Retail services in general <sup>(57)</sup> (i.e. where the specification is not limited to the sale of particular goods) is an unclear or imprecise term, as described in [paragraph 1.5.2.2](#), and should be treated accordingly.

### 5.6.2 Retail services of goods versus goods

In relation to retail services of specific goods, the similarity, or the lack thereof, between the goods to which the retail services relate and the goods themselves constitute an essential factor which needs to be taken into account. Retail services of specific goods can be similar to varying degrees, or dissimilar to specific goods depending on the

---

<sup>57</sup> ‘Retail services’ as such are not acceptable for classification purposes by the Office, unless further specified (see the Guidelines, [Part B, Examination, Section 3, Classification](#)).

degree of similarity between the goods themselves, but also taking into account other relevant factors.

#### 5.6.2.1 Retail services of specific goods versus the same specific goods

Retail services concerning the sale of specific goods are similar to an average degree to these specific goods (20/03/2018, [T-390/16](#), DONTORO dog friendship (fig.)/TORO et al., EU:T:2018:156, § 33; 07/10/2015, [T-365/14](#), TRECOLORE / FRECCIE TRICOLORI et al., EU:T:2015:763, § 34). Although the nature, purpose and method of use of these goods and services are not the same, it should be noted that they display similarities, having regard to the fact that they are complementary and that the services are generally offered in the same places as those where the goods are offered for sale. Furthermore, they are directed at the same public.

The goods covered by the retail services and the specific goods covered by the other mark have to be identical in order to find an average degree of similarity between the retail services of those goods and the goods themselves, that is to say, they must either be exactly the same goods or fall under the natural and usual meaning of the category.

#### 5.6.2.2 Retail services of specific goods versus similar specific goods

There is a low degree of similarity between the retail services concerning specific goods and other specific similar or highly similar goods, because of the close connection between them on the market from the perspective of the consumer. Consumers are accustomed to the practice that a variety of similar or highly similar goods are brought together and offered for sale in the same specialised shops or in the same sections of department stores or supermarkets. Furthermore, they are of interest to the same consumer.

A low degree of similarity between the goods sold at retail and the goods themselves may also be sufficient to lead to a finding of a low degree of similarity with the retail services provided that the goods involved are commonly offered for sale in the same specialised shops or in the same sections of department stores or supermarkets, belong to the same market sector and, therefore, are of interest to the same consumer.

Such goods and services are dissimilar, when the goods at issue are not offered in the same places, do not belong to the same market sector and target a different consumer.

#### 5.6.2.3 Retail services of specific goods versus dissimilar specific goods

When goods sold at retail are dissimilar to the actual goods themselves, no similarity can be found between them.

### 5.6.3 Retail services versus retail services or retail services of specific goods

Retail services in general (i.e. where the specification is not limited to the sale of particular goods) is an unclear or imprecise term, as described in [paragraph 1.5.2](#), and should be treated accordingly.

### 5.6.4 Retail services of specific goods versus retail services of other specific goods

Retail services of specific goods and retail services of other specific goods have the same nature as both are retail services, have the same purpose of allowing consumers to conveniently satisfy different shopping needs, and have the same method of use.

Similarity is found between the retail services of specific goods where the goods are commonly retailed together in the same outlets and they are directed at the same public. However, the degree of similarity between retail of specific goods on the one hand and retail of other specific goods on the other hand may vary depending on the proximity of the retailed goods and the particularities of the respective market sectors.

Similarity is, in principle, excluded where the goods concerned are not commonly retailed together and target different publics, or are dissimilar. Nevertheless, a degree of similarity may still be found if, because of the particularities of the market, such dissimilar goods are retailed together in the same outlets and target the same public.

### 5.6.5 Services to which the same principles apply

The principles set out above in relation to retail services apply to the various services rendered that revolve exclusively around the actual sale of goods, such as **retail store services**, **wholesale services**, **internet shopping**, **catalogue or mail order services**, etc. (to the extent that these fall into Class 35).

### 5.6.6 Services to which the same principles do not apply

In contrast, the principles set out above in relation to retail services do not apply to other services that do not revolve exclusively around the sales of goods, or that do not fall into Class 35, such as **auctioneering services** (Class 35), **import and export services** (Class 35), **distribution and transport services** (Class 39) or **repair services** (Class 37), etc.

Example

#### **Import and export services**

Import and export services are not considered to be a sales service and thus cannot be subject to the same arguments as the comparison of goods with retail or wholesale services.

Import and export services relate to the movement of goods and normally require the involvement of customs authorities in both the country of import and the country of export. These services are often subject to import quotas, tariffs and trade agreements. While these services are aimed at supporting or helping other businesses to do business and are preparatory or ancillary to the commercialisation of goods, they do not relate to the actual retail or wholesale of the goods. For these reasons, goods are to be considered dissimilar to import and export services for those goods. The fact that the subject matter of the import/export services and the goods in question are the same is not a relevant factor for finding similarity.

## 5.7 Transport, Packaging and Storage

*Transport services* are not considered to be similar to goods. These services are provided by specialist transport companies whose business is not the manufacture and sale of the goods concerned. As regards the nature of the goods and services, *transport services* refer to a fleet of trucks or ships used to move goods from A to B.

Equally, *packaging and storage services* merely refer to the service whereby a company's or any other person's goods are packed and kept in a particular place for a fee. Those services are not similar to any kind of goods, including any of the goods that may be packaged and stored (07/02/2006, [T-202/03](#), Comp USA, EU:T:2006:44, § 43-49; 22/06/2011, [T-76/09](#), Farma Mundi Farmaceuticos Mundi, EU:T:2011:298, § 32; 07/01/2014, [R 1006/2012-G](#), Pionono (fig.), § 38)

## 5.8 Information Technology

### 5.8.1 Software versus apparatus/services that use software

In today's high-tech society, almost all *electronic or digital apparatus* function using integrated *software*. Also, many services in the financial or business sectors in the IT and telecommunication industries clearly depend on software or computer-aided software in order to be rendered. This does not, however, lead to the automatic conclusion that software is similar to goods/services that use software to function successfully.

When the software is not an integral part of an apparatus/service, can be purchased independently from it and serves, for example, to give more or different functionalities, a degree of similarity can be established, if other relevant factors apply.

### 5.8.2 Specific software versus specific software

There are many types of software, and although software by nature (a set of instructions that enables a computer to perform a task) is the same, this does not mean that the specific purpose of one type of software is the same as that of another. This implies that very specific software could be dissimilar to another type of software,

depending, for instance, on the particular field of their application, the expertise needed to develop the types of software, whether they target the same users and whether they are marketed through the same distribution channels.

### 5.8.3 Communications equipment, computers and software (Class 9) versus telecommunication services (Class 38)

Communications equipment includes means, such as computer networking-, broadcasting-, data- and point-to-point communications equipment, antennas and aerials to enable remote communication.

Owing to rapid developments in the field of information technology, in particular the growing importance of the internet, the markets for communications equipment, IT hardware and software on the one hand, and telecommunications services on the other, have clearly become interlinked.

Goods such as modems, telephones, smartphones, computers, network routers and/or servers are used in close connection with telecommunication services because they are, or can be, absolutely necessary for performing these services and, from the viewpoint of the consumer, they are indispensable for accessing them. They are, moreover, regularly marketed together.

Nowadays, computers are generally networked and their autonomous use is actually the exception to the rule; the rule being that communications equipment, computers and software, insofar as they enable access to those services or provide the ability to perform them, renders them complementary. See decision of 25/04/2017, [R 1569/2016-1](#), § 22-23; judgment of 15/10/2018, [T-444/17](#), *life coins / LIFE et al.*, EU:T:2018:681, § 37.

Therefore, these goods and services are similar, given their complementary character; although their nature is different, their purpose, consumers and distribution channels are the same.

By analogy, peripherals adapted for use with computers and other smart devices are to be found similar to telecommunication services insofar as they comply with the above rule that they enable access to telecommunication services, such as visual display screens would but, for example, mouse pads would not.

***GUIDELINES FOR EXAMINATION OF  
EUROPEAN UNION TRADE MARKS***

***EUROPEAN UNION  
INTELLECTUAL PROPERTY OFFICE  
(EUIPO)***

***Part C***

***Opposition***

***Section 2***

***Double identity and likelihood of confusion***

***Chapter 3***

***Relevant public and degree of attention***

## Table of Contents

<b>1 Introduction.....</b>	<b>946</b>
1.1 Comparison of the goods and services.....	946
1.2 Comparison of the signs.....	946
1.3 Distinctive elements of the signs/distinctiveness of the earlier mark.....	947
<b>2 Defining the Relevant Public.....</b>	<b>947</b>
<b>3 Defining the Degree of Attention.....</b>	<b>951</b>
3.1 Higher degree of attention.....	952
3.1.1 Expensive purchases.....	952
3.1.2 Potentially hazardous purchases.....	953
3.1.3 Brand loyalty.....	953
3.1.4 Pharmaceuticals.....	953
3.2 Lower degree of attention.....	954



## 1 Introduction

With regard to the relevant public, the Court of Justice has held that a likelihood of confusion (including a likelihood of association) exists if there is a risk that the public might believe that the goods or services in question come from the same undertaking or, as the case may be, from economically linked undertakings (29/09/1998, [C-39/97](#), Canon, EU:C:1998:442, § 29). The Court has also held that it is the **perception of marks in the mind of the relevant public of the goods or services in question** that plays a decisive role in the global assessment of the likelihood of confusion (11/11/1997, [C-251/95](#), Sabèl, EU:C:1997:528, § 23; 22/06/1999, [C-342/97](#), Lloyd Schufabrik, EU:C:1999:323, § 25).

Accordingly, the first task is to define the consumer circles that are relevant for the purposes of the case. The method for identifying the relevant public is discussed in [paragraph 2](#) below. Thereafter, the relevant public's degree of attention and sophistication must be established. The impact of the relevant public's attention and sophistication on the assessment of the likelihood of confusion is discussed in [paragraph 3](#).

In addition, the relevant public plays an important role in establishing a number of other factors that are relevant for the assessment of the likelihood of confusion.

### 1.1 Comparison of the goods and services

The actual and potential customers of the goods and services in dispute constitute one of the factors to be dealt with in the analysis of their similarity. While a coincidence in the relevant public is not necessarily an indication of similarity of the goods or services, largely diverging publics weigh heavily against similarity (see the Guidelines, [Part C, Opposition, Section 2, Double Identity and Likelihood of Confusion, Chapter 2, Comparison of Goods and Services](#)).

#### Example

*Leather, animal skins and hides* are raw materials that go to industry for further processing, whereas *goods made of leather* are final products targeted at the general public. The relevant public is different, which is a fundamental factor in the assessment of similarity and which leads to the conclusion that the goods in question are dissimilar. Similar reasoning applies to *precious metals* and *jewellery*.

### 1.2 Comparison of the signs

The question of the relevant public also plays a role in the comparison of the signs. The same word may be pronounced differently depending on the relevant public. Conceptually, the public in one part of the European Union may understand the meaning of the sign, while consumers in other parts may not understand it (see the

Guidelines, [Part C, Opposition, Section 2, Double Identity and Likelihood of Confusion, Chapter 4, Comparison of Signs](#)).

#### Example

The Court has already confirmed that the general public in the Scandinavian countries, the Netherlands and Finland has a basic understanding of English (26/11/2008, [T-435/07](#), New Look, EU:T:2008:534, § 23).

### **1.3 Distinctive elements of the signs/distinctiveness of the earlier mark**

The inherent distinctiveness of a sign or one of its elements also depends on the relevant public for the goods and services. For example, depending on the relevant public's knowledge, background and language, an element contained in a trade mark may be non-distinctive or have a low degree of distinctiveness, or it may be distinctive because, inter alia, it is perceived as a fanciful term without any meaning claimed (see the Guidelines, [Part C, Opposition, Section 2, Double Identity and Likelihood of Confusion, Chapter 5, Distinctiveness of the Earlier Mark](#)).

#### Example

The French word 'cuisine' will not be understood as a descriptive indication for goods in Classes 29 and 30 in some Member States (23/06/2010, [R 1201/2009-1](#), GREEN CUISINE / Cuisine (fig.), § 29-33).

#### Example

Professionals in the IT and scientific fields are in general more familiar with the use of technical and basic English words than the general public. In *Gateway v Activy Media Gateway*, the Court held that the common word 'gateway' directly evokes, in the mind of the relevant consumer, the concept of a gateway, which is commonly used in the computing sector (27/11/2007, [T-434/05](#), Activy Media Gateway, EU:T:2007:359, § 38, 48; confirmed 11/12/2008, [C-57/08 P](#), Activy Media Gateway, EU:C:2008:718).

## **2 Defining the Relevant Public**

In accordance with [Article 8\(1\)\(b\) EUTMR](#), it must be determined whether a likelihood of confusion exists 'on the part of the public in the territory where the earlier mark is protected'.

The term '**average consumer**' is a legal concept that is used in the sense of the '**relevant consumer**' or '**relevant public**'. It should not be confused with the 'general public' or 'public at large', although the Courts sometimes use it in this sense. However, in the context of relative grounds, the term 'average consumer' must not be used as a synonym of 'general public' as it can refer to both **professional** and **general public**. In this respect, in cases concerning the likelihood of confusion, the Court normally distinguishes between the **general public** (or **public at large**), and a **professional or**

**specialised public** (or **business customers**), based on the goods and services in question.

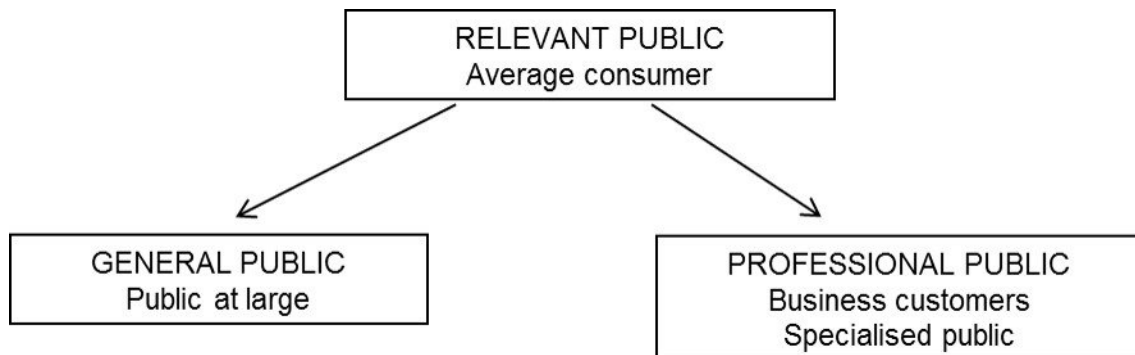

In order to properly define the relevant public in the context of relative grounds, two factors have to be taken into account:

- **the territory defined by the earlier mark:** the relevant public is always the public in the territory(ies) where the earlier right(s) is/are protected. Consequently, in the case of an earlier national right, the relevant public concerned is the one of that particular EU Member State (or Member States in the case of Benelux trade marks). For an earlier European Union trade mark, the public in the whole European Union has to be taken into account. For an international registration, it is the public in each of the Member States where the mark is protected.
- **the goods and services that have been found identical or similar:** likelihood of confusion is always assessed against the perception of the consumers of the goods and services that have been found identical or similar. Depending on the goods or services, the relevant public is the general public or a professional/specialised public.

The relevant public always includes both the **actual** and the **potential** consumers, that is, the consumers who are currently purchasing the goods/services or who may do so in the future.

If a **significant part of the relevant public** for the goods or services at issue may be confused as to the origin of the goods, this will be sufficient to establish a likelihood of confusion. It is not necessary to establish that all actual or potential consumers of the relevant goods or services are likely to be confused.

As stated by the Court, the relevant public for the assessment of the likelihood of confusion is composed of **users likely to use both the goods and services covered by the earlier mark and the product covered by the mark applied for that were found to be identical or similar** (01/07/2008, [T-328/05](#), Quartz, EU:T:2008:238, § 23; appeal 10/07/2009, [C-416/08 P](#), Quartz, EU:C:2009:450, dismissed).

When defining the part of the public **by reference to which a likelihood of confusion is assessed** the following applies:

- if the goods or services of both marks target the general public, the relevant public by reference to which a likelihood of confusion will be assessed is the general public.

### Example

In a case in which both the earlier and the contested mark concerned articles of clothing, the Court held that ‘clothing for men and women are everyday consumer items and the trade mark on which the opposition is based is registered as a European Union trade mark. It follows that the relevant public by reference to which the likelihood of confusion must be assessed is composed of the general public in the European Union’ (06/10/2004, [T-117/03](#) – [T-119/03](#) & [T-171/03](#), NL, EU:T:2004:293, § 25).

- If the goods and services of **both marks** are directed at the same or a similar **professional public**, the likelihood of confusion will be assessed from the perspective of those specialists.

### Example

The relevant goods of both the earlier and the contested mark were raw plastic materials, chemical products, resins and the like. These are goods for industrial use. The targeted consumers are, therefore, engineers and/or chemists, that is to say, highly skilled professionals who will process these products and use them in manufacturing activities. The relevant public was considered to be professional (15/02/2012, [R 2077/2010-1](#), PEBAFLEX / PEBAX, § 18; 16/09/2010, [R 1370/2009-1](#), CALCIMATT / CALCIPLAST et al., § 20, confirmed 29/03/2012, [T-547/10](#), EU:T:2012:178).

- If the goods or services of **both marks** target **both the general public and specialists**, the likelihood of confusion will be assessed against the perception of the part of the public displaying the lower degree of attentiveness as it will be more prone to being confused. If this part of the public is not likely to be confused, it is even more unlikely that the part of the public with a higher degree of attention will be.

### Example

In a case in which both the earlier and the contested mark concerned goods in Classes 3 and 5 that targeted both the general public and professionals (e.g. doctors for pharmaceuticals in Class 5), the Court assessed the likelihood of confusion for the general public only, because it is the one displaying the lower degree of attention (15/07/2011, [T-220/09](#), ERGO, EU:T:2011:392, § 21).

- If the goods and services of the earlier mark target the **general and professional public** and the contested goods and services target a **professional public** exclusively (or vice versa), the relevant public for assessing likelihood of confusion will be the professional public only.

### Example

The goods of the earlier mark are *polish for metals*, while the goods of the application are *preparations for cleaning waste pipes for the metal-working industry*. As stated in the relevant GC judgment: ‘Although “polish for metals” can consist equally well of everyday consumer goods as of goods intended for a professional or specialised public, it is not disputed that the goods to which the trade mark application relates must be regarded as directed solely at persons operating in the metal-working industry.’

Therefore, the only public likely to confuse the trade marks in question is formed of such operators' (14/07/2005, [T-126/03](#), Aladin, EU:T:2005:288, § 81).

#### Example

*Paints in general* are sold both to professional painters (i.e. for business purposes) and to the public at large for 'do-it-yourself purposes'. By contrast, *paints for industry* do not target the general public. Therefore, when the specifications of the two marks cover paints in general and paints for industry respectively, only professionals constitute the relevant public since they are likely to be the only consumers who encounter both marks.

#### Example

The services of the earlier mark are *telecommunications*. The contested services are *telecommunication services, namely collocation, telehousing and interconnection services* addressed at professionals only. The definition of the relevant public must be adjusted to the more specific list, and likelihood of confusion should be assessed for professionals only (24/05/2011, [T-408/09](#), ancotel, EU:T:2011:241, § 38-50).

- If the relevant goods are pharmaceuticals the following applies:  
The relevant public of **non-prescription** pharmaceuticals (sold over the counter) is the general public, and the likelihood of confusion will be assessed in relation to that public.

According to the case-law, the general public cannot be excluded from the relevant public, also in the case of pharmaceuticals that require a **doctor's prescription** prior to their sale to end-users in pharmacies. Thus, the relevant public comprises both general public and health professionals, such as doctors and pharmacists. Consequently, even though the choice of those products is influenced or determined by intermediaries, a likelihood of confusion can also exist for the general public, since they are likely to be faced with those products, even if that takes place during separate purchasing transactions for each of those individual products at various times (09/02/2011, [T-222/09](#), Alpharen, EU:T:2011:36, § 42-45; 26/04/2007, [C-412/05 P](#), Travatan, EU:C:2007:252, § 56-63). In practice, this means that the likelihood of confusion will be assessed against the perception of the general public, which is more prone to confusion.

In the case of pharmaceutical goods **targeted only at specialists** for professional use (e.g. *sterile solutions for ophthalmic surgery*), the likelihood of confusion must be assessed from the point of view of that specialist public only (26/04/2007, [C-412/05 P](#), Travatan, EU:C:2007:252, § 66).

In cases where the pharmaceutical goods of the EUTM application are **sold over the counter**, while the pharmaceutical goods covered by the earlier registration would **only be available on prescription, or vice versa**, the Office must assume that the relevant public consists of both qualified professionals and the general public, without any specific medical and pharmaceutical knowledge. The likelihood of confusion will be assessed in relation to the general public, which is more prone to confusion.

### Example

The goods covered by the earlier mark were pharmaceutical preparations with *digoxin for human use for cardiovascular illnesses*, while the contested goods were *pharmaceutical preparations for the treatment of metabolic disorders adapted for administration only by intravenous, intra-muscular or subcutaneous injection*.

Although both the goods of the earlier mark and the goods of the contested mark are prescribed by and administered under the supervision of healthcare professionals, the GC held that the relevant public comprises both healthcare professionals and the general public.

(23/09/2009, [T-493/07](#), [T-26/08](#) & [T-27/08](#), Famoxin, EU:T:2009:355, § 50-54; 09/07/2010, [C-461/09 P](#), Famoxin, EU:C:2010:421).

## 3 Defining the Degree of Attention

The Court has indicated that for the purposes of the global assessment, the average consumer of the products concerned is deemed to be **reasonably well informed** and **reasonably observant and circumspect**, and that the relevant public's degree of attention is likely to vary according to the category of goods or services in question (22/06/1999, [C-342/97](#), Lloyd Schuhfabrik, EU:C:1999:323, § 26).

Whether its degree of attention will be **higher or lower will depend, inter alia, on the nature of the relevant goods and services and the knowledge, experience and purchase involvement of the relevant public**.

The fact that the relevant public consists of the **general public** does not necessarily mean that the degree of attention cannot be high (for instance, when expensive, potentially hazardous or technically sophisticated goods are purchased). Likewise, the fact that the goods at issue target **specialists** does not necessarily mean that the degree of attention is always high. It is true that, in principle, the professional public has a high degree of attention when purchasing a specific product. This is when these professional consumers are considered to have special background knowledge or experience in relation to the specific goods and services. Moreover, purchases made by professional consumers are often more systematic than the purchases made by the general public. However, this is not always the case. However, in some cases, for example, such as when the relevant goods or services are used by a given professional on a daily basis, the degree of attention paid may be average or even low even in relation to those professional consumers.

**Properly defining the degree of attention of the relevant public is necessary, as this factor can weigh for or against a finding of a likelihood of confusion.** Whilst the relevant consumer only rarely has the chance to make a direct comparison between the different signs and must rely on an imperfect recollection of them, a high degree of attention of the relevant consumer may lead to conclude that the relevant consumer will not confuse the marks, despite the lack of direct comparison between



the trade marks (22/03/2011, [T-486/07](#), CA, EU:T:2011:104, § 95). Therefore, the degree of attention will be established in the decision.

However, **a high degree of attention does not automatically lead to a finding of no likelihood of confusion**. All the other factors have to be taken into account (**interdependence principle**) (see the Guidelines, [Part C, Opposition, Section 2, Double Identity and Likelihood of Confusion, Chapter 7, Global Assessment](#)). For example, in view of the specialised nature of the relevant goods and/or services and the high degree of attention of the relevant public, likelihood of confusion may be ruled out (26/06/2008, [T-79/07](#), Polaris, EU:T:2008:230, § 50-51). However, a likelihood of confusion can exist despite a high degree of attention. For example, when there is a strong likelihood of confusion created by other factors, such as identity or close overall similarity of the marks and the identity of the goods, the attention of the relevant public alone cannot be relied upon to prevent confusion (21/11/2013, [T-443/12](#), ancotel, EU:T:2013:605, § 53-56; 06/09/2010, [R 1419/2009-4](#), Hasi (fig.) / Hasen IMMOBILIEN).

### 3.1 Higher degree of attention

A higher degree of attention is usually connected with the following types of purchases: expensive purchases, the purchase of potentially hazardous or technically sophisticated goods. The average consumer often seeks professional assistance or advice when choosing or buying certain types of goods and services (e.g. cars, pharmaceutical products).

A higher degree of attention can also apply to goods when brand loyalty is important for the consumer.

#### 3.1.1 Expensive purchases

When purchasing expensive goods, the consumer will generally exercise a higher degree of care and will buy the goods only after careful consideration. Non-specialised or non-professional consumers often seek professional assistance or advice when choosing or buying certain types of goods and services. The attention may be enhanced in cases of luxury goods and where the specific product is regarded as reflecting the social status of its owner.

#### Examples

**Cars.** Taking into consideration their price, consumers are likely to pay a higher degree of attention than for less expensive purchases. It is to be expected that these consumers will not buy a car, either new or second-hand, in the same way as they would buy articles purchased on a daily basis. The consumer will be an informed one, taking all relevant factors into consideration, for example, price, consumption, insurance costs, personal needs or even prestige (22/03/2011, [T-486/07](#), CA, EU:T:2011:104, § 27-38; 21/03/2012, [T-63/09](#), Swift GTi, EU:T:2012:137, § 39-42).

**Diamonds, precious and semi-precious stones.** In its decision of 09/12/2010, [R 900/2010-1](#), Leo Marco (fig.) / LEO, § 22, the Board held that consumers generally

put a certain amount of thought into the selection of these goods. In many cases the goods will be luxury items or will be intended as gifts. A relatively high degree of attention on the part of the consumer may be assumed.

**Financial services.** These services target the general public, which is reasonably well informed and reasonably observant and circumspect. However, since such services are specialised services that may have important financial consequences for their users, the consumers' degree of attention would be rather high when choosing them ([T-220/11](#), F@ir Credit, EU:T:2012:444; 14/11/2013, [C-524/12 P](#), F@ir Credit, EU:C:2013:874, appeal dismissed; 22/06/2010, [T-563/08](#), Carbon Capital Markets, EU:T:2010:251, § 33).

**Real estate services.** The purchase and sale of property are business transactions that involve both risk and the transfer of large sums of money. For these reasons, the relevant consumer is deemed to possess a higher-than-average degree of attention, since the consequences of making a poor choice through lack of attentiveness might be highly damaging (17/02/2011, [R 817/2010-2](#), FIRST THE REAL ESTATE (fig.) / FIRST MALLORCA (fig.) et al., § 21).

### 3.1.2 Potentially hazardous purchases

The impact on safety of goods covered by a trade mark (e.g. lights for vehicles, saws, electric accumulators, electric circuit breakers, electric relays) may result in an increase in the relevant consumer's degree of attention (22/03/2011, [T-486/07](#), CA, EU:T:2011:104, § 41).

### 3.1.3 Brand loyalty

Furthermore, a higher degree of attention can be the consequence of brand loyalty.

#### Example

Although tobacco products are relatively cheap articles for mass consumption, smokers are considered particularly careful and selective about the brand of cigarettes they smoke, so a higher degree of brand loyalty and attention is assumed when tobacco products are involved. Therefore, in the case of tobacco products a higher degree of similarity of signs may be required for confusion to occur. This has been confirmed by several Board decisions: 26/02/2010, [R 1562/2008-2](#), victory slims (fig.) / VICTORIA et al., where it was stated that the consumers of Class 34 goods are generally very attentive and brand loyal, and 25/04/2006, [R 61/2005-2](#), Granducato / DUCADOS et al.

### 3.1.4 Pharmaceuticals

It is apparent from the case-law that, insofar as pharmaceutical preparations are concerned, the relevant public's degree of attention is relatively high, whether or not issued on prescription (15/12/2010, [T-331/09](#), Tolposan, EU:T:2010:520, § 26; 15/03/2012, [T-288/08](#), Zydus, EU:T:2012:124, § 36 and quoted case-law).



In particular, *medical professionals* have a high degree of attentiveness when prescribing medicines. With regard to *non-professionals*, they also show a higher degree of attention, regardless of whether the pharmaceuticals are sold without prescription, as these goods affect their state of health.

### 3.2 Lower degree of attention

A **lower degree of attention** can be associated, in particular, with habitual buying behaviour. Purchase decisions in this area relate to, for example, inexpensive goods purchased on a daily basis (15/06/2010, [T-547/08](#), Strumpf, EU:T:2010:235, § 43).

The mere fact that the relevant public makes an impulse purchase of some goods (e.g. sweets) does not mean that the degree of that public's attention is lower than average (09/04/2014, [T-623/11](#), Milanówek cream fudge, EU:T:2014:199, § 34).

***GUIDELINES FOR EXAMINATION OF  
EUROPEAN UNION TRADE MARKS***

***EUROPEAN UNION  
INTELLECTUAL PROPERTY OFFICE  
(EUIPO)***

***Part C***

***Opposition***

***Section 2***

***Double identity and likelihood of confusion***

***Chapter 4***

***Comparison of signs***

## Table of Contents

<b>1 Introduction.....</b>	<b>958</b>
1.1 General Principles of Trade Mark Comparison.....	958
1.2 Signs to be compared and negligible elements.....	959
1.3 Relevant territory and relevant public.....	961
<b>2 Identity between the Signs.....</b>	<b>962</b>
2.1 The concept of identity.....	962
2.2 Threshold for a finding of identity.....	963
2.3 Identity between word marks.....	964
2.4 Word marks and figurative marks.....	966
2.5 Identity between figurative marks.....	966
2.6 Identity of an earlier black and white or greyscale mark with a colour mark application.....	967
<b>3 Similarity between the Signs.....</b>	<b>969</b>
3.1 Introduction.....	969
3.2 Distinctive elements of the marks.....	969
3.2.1 What is a component of a sign?.....	970
3.2.2 Examination of distinctiveness.....	971
3.2.3 Specific cases.....	977
3.3 Dominant elements of the marks.....	981
3.4 Comparison of signs.....	985
3.4.1 Visual comparison.....	985
3.4.2 Phonetic comparison.....	1004
3.4.3 The semantic content of marks.....	1031
3.4.4 Conceptual comparison.....	1048
3.4.5 Impact of the distinctive and dominant character of the components on the similarity of signs.....	1068
3.4.6 Other principles to be taken into account in the comparison of signs.....	1075
3.5 Conclusion on similarity.....	1087
<b>4 Dissimilarity of Signs.....</b>	<b>1092</b>
4.1 Introduction.....	1092
4.2 Scenarios for dissimilarity.....	1092
4.2.1 No element in common.....	1092
4.2.2 Overlap in a negligible element.....	1093
4.2.3 Overlap in a verbal element not noticeable due to high stylisation.....	1093
4.2.4 Overlap in other irrelevant aspects.....	1094

4.2.5 Overlap in a non-distinctive element..... 1096

# 1 Introduction

Whether a likelihood of confusion exists depends on several interdependent factors, including (i) the similarity between the goods and services, (ii) the relevant public, (iii) the **similarity between the signs**, taking into account their distinctive and dominant elements, and (iv) the distinctiveness of the earlier mark.

This chapter deals with the comparison of signs. The purpose of comparing signs is to determine if the signs are identical (see [paragraph 2 below](#)), similar (see [paragraph 3 below](#)), or dissimilar (see [paragraph 4 below](#)).

**Identity** between the signs is a prerequisite for applying [Article 8\(1\)\(a\) EUTMR](#) if the goods or services are also identical ('double identity').

**Similarity** (or identity) between the signs is a prerequisite for applying [Article 8\(1\)\(b\) EUTMR](#) (likelihood of confusion).

**Dissimilarity** between the signs excludes the likelihood of confusion. There is no need to examine further prerequisites of [Article 8\(1\)\(b\) EUTMR](#).

## 1.1 General Principles of Trade Mark Comparison

If the signs are not identical, it must be determined whether they are similar or dissimilar. A global appreciation of the visual, aural or conceptual similarity of the marks in question must be based on the overall impression given by them, bearing in mind their distinctive and dominant components (11/11/1997, [C-251/95](#), Sabèl, EU:C:1997:528, § 23).

It follows that signs are compared **visually** (see [paragraph 3.4.1](#) below), **aurally** (see [paragraph 3.4.2](#) below) and **conceptually** (see [paragraphs 3.4.3](#) and [3.4.4](#) below). If it is not possible to compare the marks in any of these aspects, this will be stated in the decision.

Furthermore, when signs are compared, an assessment must be made of the distinctive character and dominance of their elements, if any, and the impact of these elements on the overall impression.

In light of the above, where the signs are not identical, they are, in principle, compared by assessing the distinctive and dominant character of the coinciding and differing elements, assessing the common features of and differences between the signs, and reaching a conclusion on similarity or dissimilarity.

The Court has stated that if there is **some similarity, even faint**, between the marks, a global assessment must be carried out in order to ascertain whether, notwithstanding the low degree of similarity, there is, on account of the presence of other relevant factors such as the reputation or recognition enjoyed by the earlier mark, a likelihood of confusion between the marks (24/03/2011, [C-552/09 P](#), TiMiKinderjoghurt, EU:C:2011:177, § 66).

In principle, the comparison has to lead to a finding on the **degree of similarity** in every aspect.

The degree of similarity between the signs may be decisive for the outcome of the decision. Even for identical goods and/or services, ‘any similarity’ may not be sufficient in itself to lead to a likelihood of confusion (interdependence principle, see Guidelines, [Part C, Opposition, Section 2, Double Identity and Likelihood of Confusion, Chapter 7, Global Assessment, paragraph 2](#)). The degree of similarity must be established in particular for the **visual** and **aural** aspects as these may be decisive for assessing the likelihood of confusion, depending on the circumstances in which the goods and services at issue are normally marketed (see the Guidelines, [Part C, Opposition, Section 2, Double Identity and Likelihood of Confusion, Chapter 7, Global Assessment, paragraph 4](#)).

In determining the degree of similarity, it is important to specify whether it is high (above average) or low (below average). However, even if it is average, the decision should say so, to avoid misunderstandings. A mere statement that ‘the signs are similar’ is not clear as it can be interpreted in two ways — either in the sense that they are similar to an average degree, or just in the general sense that there is (some) similarity allowing for further examination.

Accordingly, the degree of similarity must be specified as low, average or high. Synonyms can be used insofar as they are clear (e.g. average = medium). However, the term ‘enhanced’ is not a synonym for ‘high’. Further degrees of similarity may be specified, for example, expressions like ‘only very low’ or ‘nearly identical’, if this is supported by the facts of the case and is conducive of the outcome. The wording, however, must be as clear as possible. This is not the case for expressions like ‘not particularly high’, which can be understood either as average’ or just ‘low’.

However, it is not always necessary to specify the degree of **conceptual** similarity. Depending on the particular circumstances, it may be sufficient to acknowledge similarity resulting from a semantic overlap or a similarity in a concept. If similarity arises from concepts of low distinctive character, this must be clearly indicated so that its relevance can be considered in the global assessment of the likelihood of confusion.

## 1.2 Signs to be compared and negligible elements

The signs have to be compared in the form in which they are protected, that is, in the form in which they are registered/applied for. The actual or possible use of the registered marks in another form is irrelevant when comparing signs (09/04/2014, [T-623/11](#), Milanówek cream fudge, EU:T:2014:199, § 38).



The comparison should **cover signs in their entirety**. Consequently, it is wrong to discard comparing elements of signs just because they are, for example, smaller than other elements in the signs (unless they are negligible as explained below) or because they are non-distinctive (12/06/2007, [C-334/05 P](#), Limoncello, EU:C:2007:333, § 41-42; 13/12/2011, [T-61/09](#), Schinken King, EU:T:2011:733, § 46).

Exceptionally, in the event of **negligible elements**, the Office may decide not to take such elements into consideration for the purposes of the actual comparison, after **having duly reasoned** why they are considered negligible (12/06/2007, [C-334/05 P](#), Limoncello, EU:C:2007:333, § 42). This is especially important where the negligible element is the common element in the signs. The notion of negligible elements should be interpreted strictly and, in the event of any doubt, the decision should cover the signs in their entirety.

The Office considers that a negligible element refers to an element that, due to its size and/or position, is not noticeable at first sight or is part of a complex sign with numerous other elements (e.g. beverage labels, packaging) and, therefore, very likely to be disregarded by the relevant public.

### Examples

Earlier sign	Contested sign	Case No
	 <p>(GREEN BY MISSAKO)</p>	<p>11/11/2009, <a href="#">T-162/08</a>, EU:T:2009:432</p> <p>The words 'by missako' are almost illegible: the size and script make them difficult to decipher.</p>
	<p>LUNA</p>	<p>12/12/2011, <a href="#">R 2347/2010-2</a></p> <p>The element 'Rótulos Luna S.A.' was considered negligible.</p>
<p>MATHEUS MÜLLER</p>		<p>09/09/2010, <a href="#">R 396/2010-1</a></p> <p>The Board did not assess the elements '50 cl', '50 % vol.' 'ANNO' or '1857' phonetically or conceptually.</p>
<p>MAGNA</p>		<p>17/05/2006, <a href="#">R 1328/2005-2</a></p> <p>The Board described the contested sign in full, but negligible elements such as '70 cl' were not included in the comparison.</p>

Earlier sign	Contested sign	Case No
		<p>03/09/2010, <a href="#">T-472/08</a>, EU:T:2010:347</p> <p>The elements other than ‘cachaça’/‘pirassununga’ and ‘51’, the latter written in white within a circle that is itself partially within a broad band running from one side of the sign to the other, are negligible in the overall impression created by those marks (para. 65).</p>

It should also be noted that informative indications that the mark is registered (such as the symbols ‘™’ and ‘®’) are not considered part of the mark (see the Guidelines, [Part B, Examination, Section 2, Formalities](#)). Consequently, such symbols will not be taken into account in the comparison of the signs.

### 1.3 Relevant territory and relevant public

Similarity must be assessed for the territory in which the earlier mark is protected. The relevant territory must be indicated. Moreover, the perception of the relevant public plays an important role when comparing signs (see the Guidelines, [Part C, Opposition, Section 2, Double Identity and Likelihood of Confusion, Chapter 3, Relevant Public and Degree of Attention](#)).

Where the earlier mark is a national mark, the relevant criteria must be analysed for the relevant public in that particular EU Member State (or Member States in the case of Benelux trade marks). The perception of similarity may differ from one Member State to another because of differences in pronunciation and/or meaning/understanding.

When the earlier mark is an EUTM registration, the analysis must in principle extend to the **whole** EU. However, in situations where there is likelihood of confusion in a part of the EU **and** when justifiable for reasons of economy of procedure (such as to avoid examining specific pronunciations or meanings of marks in several languages), the Office’s analysis need not extend to the whole EU but may instead focus on only one **part or parts** where there is a likelihood of confusion.

The unitary character of the EUTM means that an earlier EUTM can be relied on in opposition proceedings against any application for registration of an EUTM that would adversely affect the protection of the first mark, even if only in the perception of consumers in part of the European Union (18/09/2008, [C-514/06 P](#), Armafoam, EU:C:2008:511, § 56-57 and subsequent case-law; 18/09/2012, [T-460/11](#), Bürger, EU:T:2012:432, § 52 and the case-law quoted).



If the opposition is based on an international registration, the territory for which the basic mark is protected is not to be considered as the relevant territory of the earlier international registration designating or subsequently designating other relevant territories (except if the owner has protection in the whole EU — IR designating or subsequently designating the EU where the same country of the basic registration is covered).

Where the relevant public consists of both general and professional consumers, the finding of a likelihood of confusion in relation to just one part of the public is sufficient to uphold the opposition. Usually it is the general public that is more prone to confusion. Consequently, if the likelihood of confusion is to be confirmed on the part of the general public, there is no need to examine it based on the perception of professionals (see the Guidelines, [Part C, Opposition, Section 0, Introduction, paragraph 4](#)).

## 2 Identity between the Signs

### 2.1 The concept of identity

As indicated above, a finding of identity between signs will lead to the success of the opposition pursuant to [Article 8\(1\)\(a\) EUTMR](#) if the goods and services are also identical.

The differences between [Article 8\(1\)\(a\) EUTMR](#) and protection in the event of likelihood of confusion, pursuant to [Article 8\(1\)\(b\) EUTMR](#), must be borne in mind in order to understand the concept of identity and its attached requirements.

Protection pursuant to [Article 8\(1\)\(a\) EUTMR](#) is absolute, because registration of a later identical sign for identical goods or services would compromise the function of the earlier mark as a means of identifying commercial origin. Where identical signs or marks are registered for identical goods or services, it is impossible to conceive of circumstances in which all likelihood of confusion could be ruled out. There is no need to consider any other factors, such as the degree of attention of the public or the distinctiveness of the earlier trade mark.

However, pursuant to [Article 8\(1\)\(b\) EUTMR](#), the earlier trade mark is protected against the likelihood of confusion: even if the trade marks differ in some elements, their similarity — in combination with further elements that have to be assessed globally — may lead to the assumption that the relevant goods and services originate from the same or an economically linked undertaking.

Due to the absolute protection conferred by [Article 8\(1\)\(a\) EUTMR](#), the concept of identity between trade marks must be interpreted strictly. The absolute protection in the case of an EUTM application ‘which is identical with the [earlier] trade mark in relation to goods or services which are identical with those for which the trade mark is registered [pursuant to [Article 8\(1\)\(a\) EUTMR](#)] cannot be extended beyond the situations for which it was envisaged, in particular, to those situations which are more specifically protected by [[Article 8\(1\)\(b\) EUTMR](#)]’ (20/03/2003, [C-291/00](#), Arthur et

Félicie, EU:C:2003:169, § 50-54 in relation to the corresponding provisions of the Directive).

## 2.2 Threshold for a finding of identity

The very definition of identity implies that the two signs should be the same in all respects. There is, therefore, identity between the signs where the EUTM application reproduces, without any modification or addition, all the elements constituting the earlier trade mark.

However, since the perception of identity between the two signs is not always the result of a direct comparison of all the characteristics of the elements compared, insignificant differences between trade marks may go unnoticed by the average consumer.

Therefore, **the EUTM application should be considered identical to the earlier trade mark ‘where it reproduces, without any modification or addition, all the elements constituting the trade mark or where, viewed as a whole, it contains differences so insignificant that they may go unnoticed by an average consumer’** (20/03/2003, [C-291/00](#), Arthur et Félicie, EU:C:2003:169, § 50-54).

An insignificant difference between two marks is a difference that a reasonably observant consumer will perceive only upon examining the marks side by side. ‘Insignificant’ is not an objective term, and its interpretation depends on the level of complexity of the trade marks being compared. Insignificant differences are those that, because they concern elements that are very small or are lost within a complex mark, cannot be readily detected by the human eye upon observing the trade mark concerned, bearing in mind that the average consumer does not normally indulge in an analytical examination of a trade mark but perceives it in its entirety.

The finding that an element is ‘insignificant’ must be accompanied by sufficient reasoning for its lack of impact on the global perception of the trade mark.

It follows from the definition of identity above that the following conditions have to be met in order for trade marks to be considered identical in accordance with [Article 8\(1\)\(a\) EUTMR](#).

- **Complete identity between the signs.** Partial identity is not sufficient under [Article 8\(1\)\(a\) EUTMR](#), but may lead to similarity between the signs and should be addressed when carrying out the examination of [Article 8\(1\)\(b\) EUTMR](#). Any additional element is sufficient for concluding that the marks are not identical; it is immaterial whether the added element is a word, a figurative device or a combination of the two.

Consequently, two word marks will not be considered identical if one is contained within the other but is accompanied by further characters (see [paragraph 2.4](#) below) or by words — irrespective of distinctiveness or possible descriptive character.

Earlier sign	Contested sign and comments	Case No
Millenium	MILLENIUIM INSURANCE COMPANY LIMITED  It was found that 'the signs at stake were obviously not identical', even if 'Insurance company limited' was descriptive in English for the related services.	24/11/2011, <a href="#">R 696/2011-1</a>
INDIVIDUAL		18/12/2008, <a href="#">R 807/2008-4</a>

- **Identity in all aspects of comparison.** There must be identity between the signs in all relevant aspects of trade mark comparison, that is, visual, phonetic and conceptual. If the trade marks are identical in some aspects but not in others, they are not identical overall. In the latter case, they may be similar and, therefore, likelihood of confusion must be examined.

### 2.3 Identity between word marks

Word marks are marks consisting of letters, numbers and other standard typographic characters (e.g. '+', '@', '!') reproduced in standard typeface. This means that they do not claim any particular figurative element or appearance. Where both marks are registered as word marks, the typeface actually used by the office concerned in the official publication is immaterial. Differences in the use of lower- or upper-case letters are, in general, immaterial. **Word marks** are identical if they coincide exactly in the string of letters, numbers or other typographic characters.

The following word marks are identical.

Earlier sign	Contested sign	Case No
BLUE MOON	Blue Moon	27/01/2011, <a href="#">R 835/2010-1</a>
GLOBAL CAMPUS	Global Campus	23/01/2009, <a href="#">R 719/2008-2</a>
DOMINO	Domino	18/03/2009, <a href="#">R 523/2008-2</a>
Apetito	APETITO	04/05/2011, <a href="#">T-129/09</a> , EU:T:2011:193

In general, it should be checked whether the sign has been registered as a word mark. For example, examining only the graphic representation of the trade mark (e.g. in the

Madrid System) can be misleading because, depending on the graphic representation of the signs used in the certificates, bulletins, etc., a mark **claimed as** a word mark may include figurative or stylised elements or fonts. In these cases, the claim will prevail over the exact reproduction in the certificate, bulletins, etc.

**Marks in non-Roman characters** must be considered as word marks in the designated jurisdictions where those characters are officially used (e.g. Cyrillic in the case of an EUTM or an IR designating Bulgaria or the EU, in accordance with the indication of category No 28.05 'inscriptions in Cyrillic characters' of the Vienna Classification of figurative elements). The following Cyrillic word marks are identical.

Earlier sign	Contested sign	Case No
ВАСИЛЪКИ	Васильки	31/01/2012, <a href="#">B 1 827 537</a>

A difference of just one letter is sufficient for a finding of non-identity.

Earlier sign	Contested sign	Case No
NOVALLOY	NOVALOY	17/12/1999, <a href="#">B 29 290</a>
HERBO FARMA	HERBOFARM	14/07/2011, <a href="#">R 1752/2010-1</a>

Whether or not a space, a punctuation mark (e.g. hyphen, full stop) or an accent, or the use of a combination of upper- and lower-case letters that departs from the usual way of writing, introduces a difference so insignificant that it may go unnoticed by the consumer in accordance with the 'Arthur et Félicie' judgment (20/03/2003, [C-291/00](#), Arthur et Félicie, EU:C:2003:169, § 50-54) is assessed on a case-by-case basis, taking into consideration the relevant language. In some languages, a term can be written either together or with a space or hyphen (e.g. weekend versus week-end) so the public will not notice the difference. However, the use of a space, hyphen or accent, or the use of a combination of upper- and lower-case letters that departs from the usual way of writing, may change the meaning of the word element and therefore influence how the sign is perceived. The following word marks **are not** identical.

Earlier sign	Contested sign	Case No
She, SHE	S-HE	23/09/2009, <a href="#">T-391/06</a> , EU:T:2009:348



## 2.4 Word marks and figurative marks

A **word mark and a figurative mark**, even when both consist of the same word, will not be identical unless the differences are so insignificant that they may go unnoticed by the relevant public.

In the following examples the signs are clearly **not identical**.

Earlier sign	Contested sign	Case No
	iHotel	13/06/2012, <a href="#">T-277/11</a> , EU:T:2012:295
	ELCO	13/03/2009, <a href="#">R 803/2008-1</a>
eClear		09/02/2012, <a href="#">R 1807/2010-1</a>
BIG BROTHER		10/05/2011, <a href="#">R 932/2010-4</a>





However, the finding that trade marks are not identical can be more difficult if the figurative trade mark is written in normal typeface. Nevertheless, in the following examples the trade marks were found **not** to be **identical**.

Earlier sign	Contested sign	Case No
	THOMSON	22/04/2009, <a href="#">R 252/2008-1</a>
	Klepper	24/02/2010, <a href="#">R 964/2009-1</a>

## 2.5 Identity between figurative marks

Two figurative marks are identical when both signs match in all their elements (shape, colours, contrast, shadowing, etc.).

It goes without saying that use of the same word will not suffice for a finding of identity when the figurative element is not the same. The following marks **are not** identical.

Earlier sign	Contested sign	Case No
		09/02/2012, <a href="#">R 558/2011-1</a>
		31/03/2011, <a href="#">R 1440/2010-1</a>
		12/04/2013, <a href="#">7078 C</a>

However, since in the following case the difference in the presentation of the letters 'TEP' in italics would go unnoticed by the public, the marks were considered **identical**.

Earlier sign	Contested sign	Case No
		28/02/2013, <a href="#">B 2 031 741</a>

## 2.6 Identity of an earlier black and white or greyscale mark with a colour mark application





Endeavouring to converge trade mark practices, the European Trade Mark and Design Network (now European Intellectual Property Network) published a Common Communication on the Common Practice of the Scope of Protection of Black and White ('B&W') Marks on 15 April 2014 ([CP4](#))<sup>(58)</sup>.

According to [CP4](#), the average consumer **will normally** notice the **differences** between an earlier black and white or greyscale mark and a version in colour of the same sign. Consequently, the marks are not considered identical. It is only under **exceptional circumstances** that the signs will be considered identical, namely where the differences in the colours or in the contrast of shades are so **insignificant** that a reasonably observant consumer will only notice them when examining the marks side



<sup>58</sup> Available at <https://www.tmdn.org/network/converging-practices>

by side. In other words, for the finding of identity the differences in the colour of the signs in question must be hardly noticeable to the average consumer.

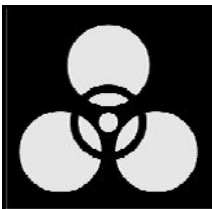

Invented examples of **significant** differences leading to a finding that the marks are not identical:

Earlier sign	Contested sign
	
	

Invented examples of **insignificant** differences leading to a finding that the marks are identical:

Earlier sign	Contested sign
	
	

The argument that the scope of protection of a black and white or greyscale mark would extend to all possible colours leading to identity with a conflicting mark in colour cannot be upheld. A mark that does not claim any specific colour cannot be considered to cover all colour combinations (09/04/2014, [T-623/11](#), Milanówek cream fudge, EU:T:2014:199, § 39; 26/03/2021, [R 551/2018-G](#), Device (fig.) / Device (fig.), § 58).

Earlier sign	Contested sign	Case No
		09/04/2014, <a href="#">T-623/11</a> , EU:T:2014:199
<p>The registration of a mark which does not designate any specific colour cannot cover all colour combinations. The yellow colour of the background in the contested mark is one of the differences between the marks (paras 39-40).</p>		

### 3 Similarity between the Signs

#### 3.1 Introduction

The similarity of signs depends on the distinctiveness (see [paragraph 3.2](#) below) and dominant character (see [paragraph 3.3](#) below) of their components, and on other possible relevant factors. When comparing signs, their visual, phonetic and conceptual similarity must be assessed by weighing up the coinciding and the differing elements, and by taking into consideration their distinctiveness and dominance (see [paragraph 3.4](#) below) as well as whether and to what extent these elements determine the overall impression conveyed by the marks.

#### 3.2 Distinctive elements of the marks

In the *Sabèl* judgment (11/11/1997, [C-251/95](#), *Sabèl*, EU:C:1997:528, § 23), the Court held that ‘... (the) global appreciation of the visual, aural or conceptual similarity of the marks in question, must be based on the overall impression given by the marks, bearing in mind, in particular, their distinctive and dominant components’. Therefore, the degree of distinctiveness of the various components of composite marks is an important criterion that must be considered within the trade mark comparison.

When assessing the similarity of signs, the degree of distinctiveness of their coinciding and differing components should be established because distinctiveness is one of the factors that determine the importance of those elements in each sign and, accordingly, their impact in the overall impression of the signs. A coincidence in a distinctive element and/or a difference in an element with no or little distinctiveness tend to increase the degree of similarity. A difference in a distinctive element tends to decrease the degree of similarity. The same applies where the coincidence found concerns an element with no or reduced distinctiveness.



Consequently, although trade mark proprietors commonly use non-distinctive or weak elements as part of a trade mark to inform consumers about certain characteristics of the relevant goods or services, it may be more difficult to establish that the public may be confused as to origin due to similarities that solely pertain to non-distinctive or weak elements.

Therefore, in principle, the distinctiveness of all components of both the earlier **and** of the contested mark should be examined.

It is important to distinguish between the analysis of the distinctive character of (i) the component of a mark and (ii) the earlier mark as a whole. Analysing the components determines whether the signs in conflict coincide in a component that is distinctive (and therefore important), non-distinctive or weak (therefore being of less importance in the trade mark comparison). The analysis of the earlier mark as a whole determines the scope of protection afforded to that mark, which is a separate consideration within the likelihood of confusion, independent from the comparison of the trade marks (see the [Guidelines, Part C, Opposition, Section 2, Double Identity and Likelihood of Confusion, Chapter 5, Distinctiveness of the Earlier Mark](#)).

However, if either mark consists of one element only, the decision in the part dealing with the comparison of signs will establish whether the distinctiveness of that element is normal or lower than normal. In this case, it cannot be found that the element lacks distinctiveness. Regarding the earlier mark, this would amount to denying its distinctive character (for details, see [paragraph 3.2.3.4](#) below). As regards the contested sign, this would mean that a new examination of absolute grounds would have to be carried out.

### 3.2.1 What is a component of a sign?

The Court has not defined what is to be regarded as a ‘component’ or ‘element’ of a sign. It is easy to identify components when a sign is visually divided into different parts (e.g. separate figurative and verbal components). However, the term ‘component’ encompasses more than these visual distinctions. Ultimately, the perception of the sign by the relevant public is decisive and a component exists wherever the relevant public perceives one. For example, the relevant public will often regard one-word signs as being composed of different components, in particular, where one part has a clear and evident meaning while the rest is meaningless or has a different meaning (e.g. in the mark EUROFIRT, ‘Euro’ will be widely understood as referring to Europe whereas ‘Firt’ is meaningless, giving this word mark two components: ‘Euro’ and ‘Firt’). In such cases, the elements of one-word signs could be regarded as ‘components’ in the terminology of the Court.

However, **words should not be artificially dissected**. Dissection is not appropriate unless the relevant public will clearly perceive the components in question as separate elements. A case-by-case assessment is required as to whether the division of a sign into components is artificial (e.g. whether splitting the word ‘LIMEON’ for fruit into the components ‘LIME’ and ‘ON’ would be artificial or not) (see also [paragraphs 3.4.3.2](#) and [3.4.5.1](#) below).

### 3.2.2 Examination of distinctiveness

#### 3.2.2.1 What is distinctiveness?

The Court has defined distinctiveness in the following manner:

In determining the distinctive character of a mark and, accordingly, in assessing whether it is highly distinctive, the national court must make an overall assessment of the **greater or lesser capacity of the mark to identify the goods or services for which it has been registered as coming from a particular undertaking, and thus to distinguish those goods or services from those of other undertakings** (emphasis added).

(22/06/1999, [C-342/97](#), Lloyd Schuhfabrik, EU:C:1999:323, § 22).

Importantly, distinctive character is a matter of degree and, when analysing distinctiveness, a sliding scale applies whereby a component of a sign can lack distinctiveness entirely, be fully distinctive (to a normal degree) or be at any point in-between.

At this point, it must be noted that it is not, in principle, the Office's practice to recognise a higher than average degree of inherent distinctiveness for individual components of signs. Any higher degree of distinctiveness (enhanced distinctiveness, reputation) is related to actual recognition of the mark by the relevant public, and is eventually examined only with respect to the earlier mark (see the Guidelines, [Part C, Opposition, Section 2, Double Identity and Likelihood of Confusion, Chapter 5, Distinctiveness of the Earlier Mark](#)). A mark or, by analogy, its components will not have a higher degree of distinctive character just because there is no conceptual link to the relevant goods and services (16/05/2013, [C-379/12 P](#), H / Eich, EU:C:2013:317, § 71).

An element of a sign is **not distinctive** if it is exclusively descriptive of the goods and services themselves or of the characteristics of those goods and services (such as their quality, value, purpose, provenance, etc.) and/or if its use in trade is common for those goods and services. Similarly, an element of a sign that is generic (such as a common shape of a container or a common colour) will also lack distinctiveness.

An element of a sign may be **distinctive to a low degree (weak) if it refers to** (but it is not exclusively descriptive of) characteristics of the goods and services. If the allusion to the goods and services is sufficiently imaginative or clever, the mere fact that there is an allusion to characteristics of the goods might not materially affect distinctiveness, as in the following examples.

- 'Billionaire' for *gaming services* is allusive in a manner that would affect distinctiveness, because it implies, for instance, that you may become a billionaire.
- 'Billy O'Naire', which sounds identical to 'billionaire' in English, would be allusive for *gaming services* as a clever word-play on Irish names, in a manner that would not affect distinctiveness in a material way; it would be considered to have a 'normal' degree of distinctiveness.

An element of a sign that is neither non-distinctive nor weakly distinctive possesses a **‘normal’ degree of inherent distinctiveness**. This means that the element of a sign in question is fully distinctive, in the sense that its capacity to identify the goods and services covered by the mark as coming from a particular undertaking is not in any way diminished or impaired.

One of the most frequent arguments brought by applicants is that the earlier trade mark or one of its components has a low distinctive character given that there are many trade marks that consist of, or include, the element in question. Where this argument is supported only by the applicant referring to trade mark registrations, the Office takes the view that the existence of several trade mark registrations is not per se particularly conclusive, as it does not necessarily reflect the situation in the market. In other words, on the basis of registered data only, it cannot be assumed that all the trade marks have been effectively used.

It follows that the evidence submitted must demonstrate that consumers have been exposed to widespread use of, and become accustomed to, trade marks that include the element in question in order to prove that the element in question has a low degree of distinctive character (13/04/2011, [T-358/09](#), Toro de Piedra, EU:T:2011:174, § 35; 08/03/2013, [T-498/10](#), David Mayer, EU:T:2013:117, § 77-79).

#### 3.2.2.2 Relevant point in time

The inherent distinctiveness of the components should be assessed at the time of the decision.

Establishing the precise point in time for evaluating distinctiveness is important because the degree of distinctiveness of the marks is not constant, but varies depending on the perception of the public. This perception may change not only due to the nature of the use of the specific mark, but also due to other factors (all these elements can only be considered from the evidence submitted by the parties). For instance, the public’s perception may change where a mark or some component thereof has been used in the meantime in a similar way by various businesses/traders in the relevant market sector. This common use of a sign can erode the uniqueness of a sign and, consequently, its ability to indicate the origin of the goods and services. In this context, it is important to assess carefully whether the situation described exists in all the relevant geographical areas and with regard to all the relevant goods and services.

As an example, due to technological changes in the field of IT, there has been an increased number of instances where components such as ‘I’ (internet), ‘E’ (electronic) and ‘M’ (mobile) are used adjoined to a meaningful word. In the context of electronic communications, they are currently found to be descriptive (19/04/2004, [R 758/2002-2](#), ITUNES, § 11), whereas previously they were considered distinctive.

## 3.2.2.3 Relevant goods and services

The assessment of the **inherent distinctiveness** of the components is carried out only for the goods or services that are identical or similar, that is:

- the earlier mark is assessed with respect to the registered goods and services that are identical or similar to the contested goods and services;
- the contested trade mark is assessed with respect to the contested goods or services that are identical or similar to those of the earlier mark.

## 3.2.2.4 General principles of examination of distinctiveness

The examination of inherent distinctiveness is carried out in two phases: first, it should be determined whether the relevant public recognises semantic content of the element at issue and, second, whether or not the semantic content perceived is related to and/or commonly used in trade for the identical or similar goods and services.

As regards the **first phase**, that is to say, whether the relevant public recognises a semantic content, the inherent distinctiveness of the components of the marks has to be evaluated by taking into account (each of) the relevant geographical area(s) and their different linguistic and cultural backgrounds. As such, the public in some parts of the relevant territory might not understand the descriptive content that a mark may have in other parts. In these cases, the distinctiveness of the mark in one area is not affected by the fact that it may be perceived differently in other areas.

Below is an example of a case where linguistic considerations were vital to the issue of distinctiveness.

Earlier sign	Contested sign	Case No
FRUTISOL	Solfrutta	27/01/2010, <a href="#">T-331/08</a> , EU:T:2010:23
<p>G&amp;S: Classes 29, 30 and 32</p> <p><i>Territory:</i> EU</p> <p><i>Assessment of the components 'frut' and 'sol':</i> '... it is necessary to distinguish between the perception by the public in those Member States, such as Italy and Spain, where the elements "sol" and "frut" are generally recognisable and can be understood as alluding to "sun" and "fruit" respectively, and the perception by the public in those Member States, such as Hungary, Finland and Lithuania, where those elements have no such close equivalent in their national languages'. In the first category of Member States, consumers are liable to associate both marks with the notions of 'fruit' and 'sunshine'. There will consequently be a certain level of conceptual similarity between them. In Member States of the second category, consumers will not perceive any conceptual similarity between the signs since they will not attach any particular meaning to the constituent parts of either sign (paras 21-24).</p>		

The **second phase** consists of correlating any meaning that the public perceives in the components with the identical or similar goods and services in dispute. If the relevant public perceives this meaning as descriptive, laudatory or allusive (in a manner that materially affects distinctiveness), etc. for these goods and services, then its distinctiveness will be diminished accordingly. It may be necessary to distinguish between the various goods and services involved because the finding of no or limited distinctiveness might relate to only part of those goods and services. In the event that no meaning can be attributed to a verbal element, it cannot be descriptive, laudatory or allusive in any way and as such is considered distinctive.

The criteria applied to examining the inherent distinctiveness of a component of a sign are the same as the relevant principles applied when examining marks on absolute grounds (see the Guidelines, [Part B, Examination](#)) <sup>(59)</sup>. However, in relative grounds disputes, the question is not merely whether a component is distinctive or not (i.e. whether it reaches the minimum distinctiveness threshold for registration), but also to what degree it is distinctive within the sliding scale previously mentioned. Therefore, for instance, a term that is not descriptive but merely allusive for the goods or services in question might be distinctive enough to pass the absolute grounds test, but still have less than normal distinctiveness for the purposes of relative grounds.

The outcome of the examination of inherent distinctiveness will be one of the following.







- The component has **no distinctiveness** or has **less than normal distinctiveness**. See the examples below.
- The component has normal distinctiveness because it is neither non-distinctive nor weak for identical or similar goods or services.

As noted in [paragraph 2.1](#) above, word marks consisting of a single word may still contain various components, some of which may be more distinctive than others (27/01/2010, [T-331/08](#), Solfrutta, EU:T:2010:23).

### 3.2.2.5 Examples of descriptive components

Earlier sign	Contested sign	Case No
BYLY		14/04/2010, <a href="#">T-514/08</a> , EU:T:2010:143
<p>G&amp;S: Class 3</p> <p>Territory: EU</p> <p><i>Assessment of the element 'products':</i> '... the term "products" is not distinctive enough to be taken into consideration by the consumers' (para. 39).</p>		

<sup>59</sup> See also Objective 2 of the Common Practice on the Impact of Non-Distinctive/Weak Components on Likelihood of Confusion agreed in the framework of the European Trade Mark and Design Network.

Earlier sign	Contested sign	Case No
		22/06/2010, <a href="#">T-490/08</a> , EU:T:2010:250
<p>G&amp;S: Class 36</p> <p>Territory: EU</p> <p>Assessment of 'CAPITAL MARKETS': 'the relevant public, consisting of consumers who are very attentive, well-informed and familiar with basic English financial terminology, will attach little significance to the meaning of the words "capital" and "markets", which are descriptive of those services and which do not enable the commercial origin of the trade marks at issue to be identified' (para. 59).</p>		
Earlier sign	Contested sign	Case No
		11/01/2010, <a href="#">R 834/2009-1</a>
<p>G&amp;S: Classes 3 and 5</p> <p>Territory: EU</p> <p>Assessment of the earlier right: even though the signs have some similarities, the expression 'NATURAL BRONZE' is descriptive of the purpose of the goods (tanning) for the goods in Class 3 (para. 31).</p>		
Earlier sign	Contested sign	Case No
 (CINEDAY <i>et al.</i> )	CINETAIN	16/11/2010, <a href="#">R 1306/2009-4</a>
<p>G&amp;S: Classes 38 and 41</p> <p>Territory: Spain</p> <p>Assessment of the element 'CINE': the word 'cine' has a descriptive meaning in the sense of 'cinema (film)'. Therefore, this component has only limited relevance in the perception of the signs (para. 36).</p>		
Earlier sign	Contested sign	Case No
	NATURAL BEAUTY FROM WITHIN	19/11/2010, <a href="#">R 991/2010-2</a>

Earlier sign	Contested sign	Case No
<p>G&amp;S: Classes 3 and 5</p> <p><i>Territory:</i> Germany</p> <p><i>Assessment of the element 'NATURAL BEAUTY':</i> the element 'NATURAL BEAUTY' is a plain and essential indication of the kind and quality of the goods. The German public understands the meaning of these two basic words as well as the combination thereof (paras 31-35).</p>		
Earlier sign	Contested sign	Case No
FORCE-X	FSA K-FORCE	04/03/2015, <a href="#">T-558/13</a> , EU:T:2015:135
<p>G&amp;S: Classes 9 and 12</p> <p><i>Territory:</i> EU</p> <p><i>Assessment:</i> the word 'force', synonymous with strength and power, can describe one of the characteristics of the goods concerned. Furthermore, for some goods in Class 12, it must be held that that word can also designate one of their purposes. Furthermore, as is apparent from the evidence adduced by the applicant, the word 'force' is commonly used, on the European market, in trade marks in the domain of cycling, thus rendering it banal (paras 38-39).</p>		

### 3.2.2.6 Examples of laudatory components

Earlier sign	Contested sign	Case No
	MAGIC SEAT	09/09/2008, EU:T:2008:319 <a href="#">T-363/06</a> ,
<p>G&amp;S: Class 12</p> <p><i>Territory:</i> Spain</p> <p><i>Assessment of the element 'MAGIC':</i> the word 'magic' will be perceived by the relevant public as a simple qualifier for the word 'seat' on account of its resemblance to the Spanish word 'mágico', which is purely laudatory (para. 39).</p>		
Earlier sign	Contested sign	Case No

STAR SNACKS		11/05/2010, <a href="#">T-492/08</a> , EU:T:2010:186
<p>G&amp;S: Classes 29, 30 and 32</p> <p>Territory: EU</p> <p>Assessment of the element 'STAR': the word element 'STAR' is laudatory, as it merely constitutes (together with the remaining elements of the signs) a reference to high-quality food products (para. 52).</p>		

### 3.2.2.7 Examples of allusive components

Earlier sign	Contested sign	Case No
	WORLDBLINK	27/02/2008, <a href="#">T-325/04</a> , EU:T:2008:51
<p>G&amp;S: Class 36</p> <p>Territory: EU</p> <p>Assessment of the element 'LINK': the element 'LiNK' of the earlier mark is not immediately descriptive of inter alia 'banking services for the dispensing of cash; funds transfer and payment services; financial information services' (Class 36) covered by the earlier mark, but merely allusive in relation to them (para. 68 et seq.).</p>		

### 3.2.3 Specific cases

#### 3.2.3.1 Commonplace and banal elements

There are instances where signs are composed of one (or various) distinctive verbal element(s) and one (or various) figurative element(s) that are perceived by the relevant public as being commonplace or banal. These figurative elements frequently consist of a simple geometrical shape (e.g. frames, labels) or of colours frequently used in the market sector (e.g. red for fire extinguishers, yellow or red or orange for the postal sector depending on the Member State concerned). For this reason, these commonplace and banal elements are considered non-distinctive.



Earlier sign	Contested sign	Case No
ARCO		05/10/2011, <a href="#">R 1929/2010-2</a>
<p>G&amp;S: Class 9</p> <p>Territory: EU</p> <p><i>Assessment of figurative elements:</i> the verbal elements of the two signs coincide. Even if it is not negligible in terms of its size, the figurative element of the contested EUTM is likely to be perceived by consumers essentially as a mere decorative element, and not as an element indicating the commercial origin of the goods (para. 43).</p> <p>The marks are visually highly similar and phonetically and conceptually identical (paras 45-48).</p>		

### 3.2.3.2 Identical verbal elements accompanied by non-distinctive figurative elements

When comparing a word mark with a figurative mark containing an identical word element as its only word element, it is not necessary to assess the distinctiveness of the word if the figurative elements are not distinctive (mere colour, background or common typeface) and not dominant. In such cases, it is irrelevant that the word has only limited distinctiveness in relation to some goods and services in some languages, since this applies equally to both marks, while the figurative elements are clearly not sufficient to distinguish the marks.

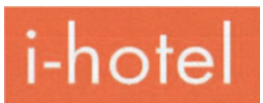
Earlier sign	Contested sign	Case No
	iHotel	13/06/2012, <a href="#">T-277/11</a> , EU:T:2012:295
<p>G&amp;S: services related to travel, accommodation and congresses in Classes 35, 39, 41, 42, 43.</p> <p>Territory: EU</p> <p><i>Assessment:</i> The Court did not go into the assessment of the inherent distinctiveness of the elements of the signs and agreed with the Board that the signs were visually highly similar and phonetically and conceptually identical (paras 83-92). The Board, therefore, correctly found the signs to be 'almost identical' (para. 93). The differentiating elements (the orange background and the particular way of writing) were considered to be insignificant.</p>		
Earlier sign	Contested sign	Case No

LEMON GOLD		21/11/2018, <a href="#">B 2 943 036</a>
<p>G&amp;S: Class 31</p> <p>Territory: Spain</p> <p><i>Assessment:</i> The earlier mark is entirely reproduced in the contested mark, where it is the only verbal component. Whether or not the identical verbal components are understood by the relevant Spanish public is immaterial since, given the present circumstances, they are on an equal footing regarding their distinctiveness. The only differences between the signs reside in the figurative elements of the contested sign, namely a lemon on a black, label-shaped, background. However, neither of these elements is distinctive given that lemons are the relevant goods and the label is a commonplace, banal shape. Consequently, the signs are aurally and conceptually identical, and visually highly similar.</p>		

### 3.2.3.3 One-letter components, numerals and short components

In its judgment of 09/09/2010, [C-265/09 P](#),  $\alpha$ , EU:C:2010:508, the Court held that the distinctiveness of single-letter trade marks must be assessed according to an examination based on the facts, focusing on the goods or services concerned and the **same criteria that apply to other word marks** (paras 33-39). Although that judgment deals with absolute grounds, the Office considers that the principle established by the Court (i.e. that the application of the criterion of distinctiveness must be the same for all marks) also applies in *inter partes* cases when it comes to determining the distinctiveness of single-letter components in trade marks.

The Court, although acknowledging that it may prove more difficult to establish distinctiveness for marks consisting of a single letter than for other word marks, held that these circumstances do not justify laying down specific criteria supplementing or derogating from application of the criterion of distinctiveness as interpreted in the case-law.

In the context of analysis of distinctiveness of components of signs, the Office considers the ruling to mean that, when establishing the distinctiveness of a single letter, being a component of a sign, it is not correct to rely on assumptions such as a priori statements that consumers are not in the habit of perceiving single letters as trade marks or on generic arguments such as that relating to the availability of signs, given the limited number of letters.

The General Court has since stated in a number of cases that a trade mark containing a **single letter** or a single numeral may indeed be inherently distinctive (08/05/2012, [T-101/11](#), G, EU:T:2012:223, § 50; 06/10/2011, [T-176/10](#), Seven for all mankind, EU:T:2011:577, § 36; 05/11/2013, [T-378/12](#), X, EU:T:2013:574, § 37-51).

In its judgment of 10/05/2011, [T-187/10](#), G, EU:T:2011:202, the General Court dismissed the applicant's argument that single letters are generally per se devoid of

distinctive character and that, therefore, only their graphic representation would be protected (paras 38-49).

The above considerations apply both to single-letter/numeral trade marks depicted in standard characters (i.e. word marks) and to stylised single-letter/numeral trade marks.

Furthermore, in accordance with the  $\alpha$  judgment, as regards these components, unless the letter combination itself is descriptive or otherwise related to the goods and services (e.g. 'S', 'M', 'XL' for goods in Class 25), these components are not necessarily limited in their distinctiveness. The same rules apply to numerals.

#### 3.2.3.4 Disclaimers

Prior to the entry into force, on 23 March 2016, of [Amending Regulation \(EU\) 2015/2424](#), it was possible to record in the Register a **disclaimer** for an element of an EUTM that was non-distinctive in a language of the European Union. International registrations having effect in the European Union or in a Member State may also include a disclaimer. Some national trade mark systems also recognise disclaimers, or did so in the past. Consequently, an opposition may be filed on the basis of a trade mark that contains a disclaimer.

When signs are being compared or a global assessment of the likelihood of confusion is being carried out, a disclaimer cannot have the effect of excluding, or attributing limited importance to, a trade mark component; both the principle of the **overall impression** conveyed by the signs and the principle of the **actual perception** of the relevant public prevail (12/06/2019, [C-705/17](#), ROSLAGSÖL, EU:C:2019:481, § 46-58, 62). Consequently, a disclaimed element cannot be disregarded when signs are compared. In general, if a disclaimed element is indeed non-distinctive, taking it into account will not produce a different outcome (12/06/2019, [C-705/17](#), ROSLAGSÖL, EU:C:2019:481, § 53 and 55). However, where the disclaimed element is non-distinctive in one language but distinctive in another which is also relevant for the comparison (as it may often happen with earlier EUTMs and international registrations designating the EU containing a disclaimer), taking the disclaimed element into account in the comparison can produce a different outcome.

Earlier sign	Contested sign	Case No
SOCK IT TO ME		26/08/2019, <a href="#">R 1880/2018-2</a>

G&S: Classes 25 and 35

Territory: EU

*Assessment:* The earlier IR designating the EU is registered for *socks and stockings* and contains a disclaimer for the word 'SOCK'. Having regard to the judgment in 12/06/2019, [C-705/17](#), ROSLAGSÖL, EU:C:2019:175, the disclaimed element must also be taken into account in the assessment of the likelihood of confusion. For the non-English-speaking part of the public, the word 'SOCK' has no meaning and is, therefore, distinctive for the goods and services at issue. There is a likelihood of confusion (paras 32, 33, 42, 56, 60-62).

### 3.2.3.5 Earlier marks, the distinctiveness of which is called into question

If the distinctiveness of the earlier mark is questioned, the Office applies the practice clarified in the *F1-Live* judgment (24/05/2012, [C-196/11 P](#), F1-Live, EU:C:2012:314), namely that in proceedings opposing the registration of an EUTM, the validity of earlier trade marks may not be called into question.

Consequently, the elements corresponding to the earlier mark cannot be considered as devoid of distinctive character in the trade mark comparison, but must be deemed to be endowed with some (low/minimal) degree of distinctiveness.

## 3.3 Dominant elements of the marks

It is the Office's practice to restrict the notion of dominant element to the visual impact of the elements of a sign, that is, to use it exclusively to mean '**visually outstanding**'.

For a finding that there is a dominant element within a sign, the sign should have at least two identifiable components <sup>(60)</sup>. The rules explained in [paragraph 3.2.1](#) above apply accordingly.

The decision should establish whether there is a dominant element or codominant elements and identify them.

Even though, according to the established case-law of the Court, aspects other than the visual one (such as a possible semantic meaning of part of a one-word sign) may come into play when defining the notion of the dominant element of a sign, it is the practice of the Office to restrict the notion of dominant element to the visual impact of the elements of a sign, that is, to use it exclusively to mean 'visually outstanding' and to leave any other considerations for the overall assessment. As a result, the Office's practice is that the dominant character of a component of a sign **is mainly determined by its position, size, dimensions and/or use of colours**, to the extent that they affect its visual impact. As stated by the Court:

<sup>60</sup> In this text the words 'component' and 'element' are used interchangeably.

With regard to the assessment of the dominant character of one or more given components of a complex trade mark, account must be taken, in particular, of the intrinsic qualities of each of those components by comparing them with those of other components. In addition and accessorially, account may be taken of the relative position of the various components within the arrangement of the complex mark.

(23/10/2002, [T-6/01](#), Matratzen + Matratzenmarkt Concord (fig.), EU:T:2002:261, § 35; confirmed 28/04/2004, [C-3/03 P](#), Matratzen + Matratzenmarkt Concord (fig.), EU:C:2004:233).

In addition, the Court has held that:

... the weak distinctive character of an element of a complex mark does not necessarily imply that that element cannot constitute a dominant element since, because, in particular, of its position in the sign or its size, it may make an impression on consumers and be remembered by them.



(13/06/2006, [T-153/03](#), Peau de vache, EU:T:2006:157, § 32).

Consequently, the fact that a component of a mark may or may not be considered non-distinctive (or as having a low degree of distinctiveness) has no bearing on the assessment of dominant character.

As a rule of thumb, the following should be considered.

- The assessment of dominant character applies to both the signs under comparison.
- For a finding that there is a dominant component, the sign should have at least two identifiable components.
- Word marks have no dominant elements because by definition they are written in standard typeface. The length of the words or the number of letters is not an issue of dominance but of overall impression (see the Guidelines, [Part C, Opposition, Section 2, Double Identity and Likelihood of Confusion, Chapter 7, Global Assessment](#)).
- Figurative elements may be dominant in signs where word elements are also present.
- Whether or not an element is visually outstanding may be determined in the visual comparison of the signs; if that is the case, it must be consistent with an evaluation of dominant character.
- Lastly, if it is difficult to decide which of the (at least) two components is dominant, this may be an indication that there is no dominant element or that no element is more dominant than the other (which includes cases of codominance). The establishment of dominant character implies that one component is visually outstanding compared to the other component(s) in the mark. If this applies to two or more components, they are codominant. If that assessment is difficult to make, it is because there is no dominant or codominant element(s).

#### Examples of cases

Sign	Dominant component and reasoning	Case No
	<p><b>RPT:</b> ‘the dominant element of the earlier marks is the acronym RPT, in which the letter “p” predominates’ (para. 33).</p>	<p>04/03/2009,  <a href="#">T-168/07</a>, EU:T:2009:51</p>
	<p><b>Free:</b> ‘the word “free” dominates the visual impression created by the mark of which it forms part, because it is considerably larger than the other components and, in addition, is much easier to remember and pronounce than the slogan in question’ (para. 39).</p>	<p>27/10/2010,  <a href="#">T-365/09</a>, EU:T:2010:455</p>
	<p><b>Xtreme:</b> ‘Visually, it must be concluded that in the mark applied for, the term “XTREME” occupies a central position. Indeed, the size of its typeface is bigger than that of the other verbal elements, and the word is highlighted with a white outline ... The other verbal components “RIGHT GUARD” and “SPORT”, are written in a much smaller type and are shifted to the right and towards the edge of the sign’ (para. 55).</p>	<p>13/04/2005,  <a href="#">T-286/03</a>, EU:T:2005:126</p>

Sign	Dominant component and reasoning	Case No
 <p>(by missako)</p>	<p><b>GREEN by missako:</b> ‘It must be noted, as a first point, that the representation of the sun has an important place within the mark applied for, in that it is positioned in the centre and covers almost two thirds of the area. Next, the position of the word element “green” is also important within the mark, as it is portrayed in large-typeface, stylised upper case letters in black and takes up about one third of the area. As observed by the Board of Appeal in para. 28 of the contested decision, those two elements thus occupy the major portion of the mark applied for and are, therefore, striking in the overall impression of the mark. Lastly, as regards the word element “by missako”, the Board of Appeal correctly held, in para. 28 of the contested decision, that those words were almost illegible because of their size and that the handwriting made them difficult to decipher. It follows, first, that the dominant nature of the word “green” and of the representation of the sun are thereby further reinforced and, secondly, that the word element “by missako” is negligible in nature’ (paras 37-39).</p>	<p>11/11/2009, <a href="#">T-162/08</a>, EU:T:2009:432</p>

Sign	Dominant component and reasoning	Case No
	<p><b>BÜRGER:</b> The dominant element of the mark applied for is undeniably the word element in upper case letters that stands out, simply because of its position and the very large size of its lettering, from all the other elements that make up the label (para. 38).</p>	<p>18/09/2012, <a href="#">T-460/11</a>, EU:T:2012:432</p>

### 3.4 Comparison of signs

In the following paragraphs the application of the principles explained above will be explained with regard to the visual (see [paragraph 3.4.1](#)), phonetic (see [paragraph 3.4.2](#)) and conceptual comparison (see paragraphs [3.4.3](#) and [3.4.4](#)). Thereafter, the impact of distinctiveness and dominant character of the common and differing elements (see [paragraph 3.4.5](#)) and other principles to be taken into account in the comparison of signs (see [paragraph 3.4.6](#)) will be presented.

Certain particularities arise when comparing non-conventional mark types (such as sound, motion or multimedia marks) owing to the particular nature of those marks. Endeavouring to converge trade mark practices, the European Intellectual Property Network published a Common Communication on New Types of Marks: Examination of Formal Requirements and Grounds for Refusal on 14 April 2021 ([CP11](#))<sup>(61)</sup>. Part C of that communication deals with ‘Examination of relative grounds for refusal and/or invalidity’. It is of particular relevance for relative grounds practice (pages 43-65 [CP11](#)). Those particularities are addressed in the relevant sections of the Guidelines on the visual ([paragraph 3.4.1](#)), phonetic ([paragraph 3.4.2](#)) and conceptual ([paragraph 3.4.4](#)) comparison.

#### 3.4.1 Visual comparison

Within the visual comparison it is important to note first that the public perceives word elements of a mark in a different way from other elements. Word elements can be read or associated with a sequence of letters. Other elements are just assessed as to their graphical or figurative characteristics. In the following, the principles of visual comparison will be presented depending on the type of trade marks involved.

<sup>61</sup> Available at <https://www.tmdn.org/network/converging-practices>.



## 3.4.1.1 Word marks versus word marks

A word mark is a mark consisting exclusively of words or letters, numerals, other standard typographic characters or a combination thereof, represented in standard script and layout, without any graphic feature or colour ([Article 3\(3\)\(a\) EUTMIR](#)).

The protection of a word mark concerns the word as such. Therefore, it is irrelevant, for the purposes of the comparison of word marks, if one of them is written in lower-case letters and the other in upper-case letters.

Earlier sign	Contested sign	Case No (degree of similarity)
BABIDU	babilu	31/01/2013, <a href="#">T-66/11</a> , EU:T:2013:48, § 57, 58 (high)
FRUTISOL	Solfrutta	27/01/2010, <a href="#">T-331/08</a> , EU:T:2010:23, § 16, 17, 24 (low)
metabiarex	METABIOMAX	11/06/2014, <a href="#">T-281/13</a> , EU:T:2014:440, § 41, 52-54 (low)

Nevertheless, where a word mark combines upper- and lower-case letters in a manner that departs from the usual way of writing ('irregular capitalisation'), this must be taken into account. Pursuant to [Article 3\(2\) EUTMIR](#), the representation of the trade mark defines the subject matter of the registration. The perception of the relevant public, who will not fail to notice the use of irregular capitalisation, also cannot be disregarded.

Irregular capitalisation may have an impact on how the public perceives the sign, and consequently, on the assessment of similarity. The impact of irregular capitalisation on the comparison of signs is assessed on a case-by-case basis. For example, it may change the meaning of the word element in the relevant language and therefore influence how the sign is perceived.

Earlier sign	Contested sign	Case No
AIDAmia	Damia	31/03/2016, <a href="#">R 3290/2014-4</a>
<p>G&amp;S: Classes 12, 18, 25, 29, 30, 32, 35</p> <p><i>Territory:</i> EU</p> <p><i>Assessment:</i> Due to its specific spelling, the earlier sign will be divided by the consumer into the words 'aida' and 'mia'. The consumer will first and foremost perceive the 'AIDA' component of the earlier mark, which has no aural or visual equivalent in the contested sign (paras 36, 38, 45).</p>		

Hence, the use of irregular capitalisation may justify breaking down a single word into components, which may result in a relevant overlap with the conflicting mark (see paragraphs [3.4.3.2](#) and [3.4.5.1](#) below).

For word marks, the visual comparison is based on an analysis of the number and sequence of the letters/characters, the position of the coinciding letters/characters, the number of words and the structure of the signs (e.g. whether word elements are separated or hyphenated).

However, the average consumer normally perceives a sign as a whole and does not proceed to analyse its various details. Therefore, small differences in the (number of) letters are often not sufficient to exclude a finding of visual similarity, particularly when the signs have a common structure.

In the following cases the marks were held to be visually similar.

Earlier sign	Contested sign	Case No (degree of similarity)
MEDINETTE	MESILETTE	13/06/2012, <a href="#">T-342/10</a> , EU:T:2012:290(average)
FORTIS	FORIS	17/03/2003, <a href="#">R 49/2002-4</a> (high)
ARTEX	ALREX	17/11/2005, <a href="#">T-154/03</a> , EU:T:2005:401 (very high)
MARILA	MARILAN	27/01/2011, <a href="#">R 799/2010-1</a> (high)
EPILEX	E-PLEX	24/05/2011, <a href="#">T-161/10</a> , EU:T:2011:244 (average)
CHALOU	CHABOU	16/11/2011, <a href="#">T-323/10</a> , EU:T:2011:678 (high)

The following word marks are visually dissimilar.

Earlier sign	Contested sign	Case No
CAPOL	ARCOL	25/03/2009, <a href="#">T-402/07</a> , EU:T:2009:85; 04/03/2010, <a href="#">C-193/09</a> P, EU:C:2010:121

Earlier sign	Contested sign	Case No
<p>The Board held that although those marks shared the letter 'a' and the ending 'ol', they 'clearly differ[ed]' visually. The General Court agreed. It held that <b>the same number of letters in two marks is not, as such, of any particular significance for the relevant public</b>, even for a specialised public. Since the alphabet is made up of a limited number of letters, which, moreover, are not all used with the same frequency, it is inevitable that many words will have the same number of letters and even share some of them, but they cannot, for that reason alone, be regarded as visually similar. In addition, the public is not, in general, aware of the exact number of letters in a word mark and, consequently, will not notice, in the majority of cases, that two conflicting marks have the same number of letters (paras 81-82). The Court held that <b>what matters in the assessment of the visual similarity of two word marks is the presence, in each of them, of several letters in the same order</b> (para. 83). The ending 'ol' of the marks at issue constituted a common element of the marks but comes at the end and is preceded by completely different groups of letters ('arc' and 'cap' respectively), so the Board of Appeal correctly concluded that that this commonality does not render the marks visually similar (para. 83). The Court of Justice upheld this assessment from a visual perspective (para. 74).</p>		

### 3.4.1.2 Word marks versus figurative marks with word elements

When figurative marks with word elements and word marks are compared visually, what matters is whether the signs share a significant number of letters in the same position and whether the word element in the figurative sign is highly stylised. Similarity may be found despite the fact that the letters are graphically portrayed in different typefaces, in italics or bold, in upper or lower case or in colour.



In principle, when the same letters are depicted in the same sequence, any variation in stylisation has to be high in order to find visual dissimilarity.

The following marks were considered visually **similar** because there was no high variation in the stylisation of the word elements in the figurative marks and the word element was easily recognisable and legible.

Earlier sign	Contested sign	Case No (degree of similarity)
VITAFIT		25/10/2012, <a href="#">T-552/10</a> , EU:T:2012:576 (average)
COTO DE IMAZ		04/02/2010, <a href="#">R 409/2009-1</a> (high)

Earlier sign	Contested sign	Case No (degree of similarity)
vendus sales & communication group		15/07/2010, <a href="#">R 994/2009-4</a> (high)

However, where the word in the figurative mark is highly stylised, the marks should be found visually **dissimilar**, as in the following examples.

Earlier sign	Contested sign	Case No
NEFF		20/09/2010, <a href="#">R 1242/2009-2</a>
	NODUS	27/07/2007, <a href="#">R 1108/2006-4</a>







The protection that results from the registration of a word mark concerns the word mentioned in the application for registration and not any specific graphic or stylistic elements that the mark might eventually adopt in the future. Therefore, the argument that a word mark may be used with a stylisation similar to that of the conflicting figurative mark, so that the signs would look more similar, cannot prosper (see, in this regard, 20/04/2005, [T-211/03](#), Faber (fig.) / NABER, EU:T:2005:135, § 37, 38; 13/02/2007, [T-353/04](#), Curon, EU:T:2007:47, § 74).

#### 3.4.1.3 Figurative marks with word elements versus figurative marks with word elements

When comparing signs in terms of their **word elements**, the Office considers signs similar insofar as they share a significant number of letters in the same position and are not highly stylised or are stylised in the same or a similar manner. Similarity may be found despite the fact that the letters are graphically portrayed in different typefaces, in italics or bold, in upper or lower case or in colour (18/06/2009, [T-418/07](#), LIBRO, EU:T:2009:208; 15/11/2011, [T-434/10](#), Alpine Pro Sportswear & Equipment, EU:T:2011:663; 29/11/2012, [C-42/12 P](#), Alpine Pro Sportswear & Equipment, EU:C:2012:765, appeal dismissed). In the following examples, the marks were considered visually **similar** because they shared some words or sequences of letters and the typeface was deemed not to be highly stylised.

Earlier sign	Contested sign	Case No (degree of similarity)
		03/09/2007, <a href="#">R 1454/2005-4</a> ; confirmed 18/06/2009, <a href="#">T-418/07</a> , EU:T:2009:208 (average)
		19/04/2016, <a href="#">T-198/14</a> , EU:T:2016:222 (high); confirmed 10/11/2016, <a href="#">C-351/16 P</a> , EU:C:2016:866
		16/01/2014, <a href="#">T-383/12</a> , EU:T:2014:12 (high)





In the following examples, however, the marks were considered visually **dissimilar** in spite of the fact that they shared some words and/or letters and/or figurative devices, because the shared letters were highly stylised and/or placed differently and/or there were additional figurative devices.

Earlier sign	Contested sign	Case No
		11/05/2005, <a href="#">T-390/03</a> , EU:T:2005:170
		23/01/2008, <a href="#">T-106/06</a> , EU:T:2008:14
		05/03/2009, <a href="#">R 1109/2008-1</a>

Earlier sign	Contested sign	Case No
	<b>HANNIBAL LAGUNA C O U T U R E</b>	02/08/2010, <a href="#">R 111/2010-4</a>

When comparing figurative signs with word elements visually, it is still possible to find visual similarity when the figurative elements are different (i.e. neither match nor have the same or similar contours) and the word elements are different. Similarity will be found when the overall stylisation, structure and colour combination render the signs visually similar overall.





The following example illustrates how similar structure, stylisation and colour combination render signs visually similar.

Earlier sign	Contested sign	Case No (degree of similarity)
		29/09/2008, <a href="#">B 1 220 724</a> (high)
		26/03/2018, <a href="#">R 1563/2017-2</a> (high)



#### 3.4.1.4 Purely figurative marks versus purely figurative marks

When comparing signs in conflict in terms of their **purely figurative elements**, the Office considers the latter as images: if they match in one, separately recognisable, element or have the same or a similar contour, it is likely that some visual similarity will be found.

The following purely figurative signs were found to be visually **similar**.

Earlier sign	Contested sign	Case No (degree of similarity)
		15/03/2012, <a href="#">T-379/08</a> , EU:T:2012:125 (average)
		11/03/2009, <a href="#">B 1 157 769</a> (medium)





The following purely figurative signs were deemed to be visually **dissimilar**.

Earlier sign	Contested sign	Case No
		11/10/2010, <a href="#">B 1 572 059</a>

#### 3.4.1.5 Figurative marks with word elements versus purely figurative marks

A coincidence in a figurative element that is visually perceived in an identical or similar way may lead to a visual similarity.

The following examples are cases where there are visual similarities because of matching figurative elements.

Earlier sign	Contested sign	Case No (degree of similarity)
		<p>14/12/2006,  <a href="#">T-81/03</a>, <a href="#">T-82/03</a> &amp; <a href="#">T-103/03</a>,                      EU:T:2006:397                      (significant)</p>
<p>(i)</p>  <p>(ii)</p> 		<p>17/11/2010,  <a href="#">R 144/2010-2</a>                      (low)</p>

In the following example the figurative elements were different and the signs were considered visually **dissimilar**.



Earlier sign	Contested sign	Case No
		<p>30/05/2002, <a href="#">B 134 900</a>                      The marks were considered visually dissimilar</p>

### 3.4.1.6 Figurative mark in black and white versus figurative mark in colour

The argument that the scope of protection of a black and white or greyscale mark would extend to all possible colours leading to a greater degree of visual similarity with a conflicting mark in colour cannot be upheld. A mark that does not claim any specific



colour cannot be considered to cover all colour combinations (09/04/2014, [T-623/11](#), Milanówek cream fudge, EU:T:2014:199, § 39; 26/03/2021, [R 551/2018-G](#), Device (fig.) / Device (fig.), § 58).

Earlier sign	Contested sign	Case No
		<p>09/04/2014, <a href="#">T-623/11</a>, EU:T:2014:199</p>
<p>The registration of a mark which does not designate any specific colour cannot cover all colour combinations. The yellow colour of the background in the contested mark is one of the differences between the marks (paras 39-40).</p>		

### 3.4.1.7 Signs consisting of a single letter

Where conflicting signs consist of the same single letter, the visual comparison is decisive.

The fact that the signs comprise the same single letter can lead to a finding of visual similarity between them, depending on the particular way the letters are depicted.

In the following examples, the signs were found to be visually similar **to a high or medium degree**.

Earlier sign	Contested sign	Case No
		<p>13/07/2004, <a href="#">T-115/02</a>, EU:T:2004:234</p>

Earlier sign	Contested sign	Case No
<p>G&amp;S: Classes 9, 16, 25, 35, 41</p> <p><i>Territory:</i> EU</p> <p><i>Assessment:</i> as regards the visual similarity of the conflicting signs, the Board of Appeal rightly considered that both marks in question include as a dominant element the lower-case white letter 'a', of a commonplace typeface, on a black background. That dominant element makes an immediate impression and is remembered. Conversely, the graphic differences between the trade marks in question — namely the shape of the background (oval for the trade mark applied for and square for the earlier trade mark), the position of the letter on that background (in the centre in the case of the trade mark applied for and in the lower right-hand corner in the case of the earlier trade mark), the thickness of the line used to represent that letter (the trade mark applied for uses a slightly broader line than that used in the earlier trade mark) and the calligraphic details of the letters of the respective marks — are minor and do not constitute elements that will be remembered by the relevant public as effective distinguishing features. Consequently, the conflicting signs are very similar from the visual point of view.</p>		
Earlier sign	Contested sign	Case No
A		20/05/2011, <a href="#">R 1508/2010-2</a>
<p>G&amp;S: Classes 9, 18, 24, 25, 28</p> <p><i>Territory:</i> Germany</p> <p><i>Assessment:</i> the Board found the signs visually similar to a medium degree.</p>		

In the following cases, the signs were found to be visually similar **to a low degree** (that resulted, depending on a particular case, in likelihood of confusion or no likelihood of confusion).

Earlier sign	Contested sign	Case No
		14/03/2017, <a href="#">T-276/15</a> , EU:T:2017:163

G&S: Class 25

*Territory:* EU

*Assessment:* even though the signs can both be perceived as representing the letter 'e', they differ visually in their respective colours, typefaces and the overall impressions they convey (para. 25).

The outcome of this case: likelihood of confusion for identical goods and services (this part of the BoA decision was not challenged before the General Court). No likelihood of confusion for the similar and dissimilar goods and services (inter alia, *electric energy emanating from wind power; plants for the production of renewable energy; leasing of wind power energy generating facilities*) for which the relevant public has a high degree of attention.

Earlier sign	Contested sign	Case No
A		22/09/2011, <a href="#">T-174/10</a> , EU:T:2011:519  dismissed 10/10/2012, <a href="#">C-611/11 P</a> , EU:C:2012:626

G&S: Classes 18, 25

*Territory:* Germany

*Assessment:* on the basis of the particular graphic design of the contested trade mark, the Court only found a low degree of visual and conceptual similarity (para. 31). A phonetic comparison was not possible, as it was found that the public would most likely not pronounce the contested trade mark given the particular graphic design (para. 32). Please note that the outcome of this case was that of no likelihood of confusion, although the Court found low visual similarity between the signs.





Earlier sign	Contested sign	Case No
F		12/06/2007, <a href="#">R 1418/2006-2</a>

G&S: Class 25



*Territory:* EU

*Assessment:* visually, the earlier mark is an upper case letter 'F' written in a standard typeface, whereas the contested mark is a stylised letter 'F', in which the horizontal line is embellished with a distinctive drawing that amounts to a relevant visual difference. The outcome of this case was that of no likelihood of confusion.

Finally, in the examples below the signs were found to be **visually dissimilar** due to the different stylisations or graphic elements of the single-letter signs. The final outcomes of these cases were those of no likelihood of confusion.

Earlier sign	Contested sign	Case No
		12/12/2007, <a href="#">R 1655/2006-4</a>
<p>G&amp;S: Class 25</p> <p>Territory: Spain</p> <p><i>Assessment:</i> even though the marks share the presence of the letter 'm', they cannot be considered visually similar since the overall visual impression that each mark makes on the relevant public is clearly distinct. The EUTM applied for is a complex graphic device that includes a black lowercase letter 'm' and in addition, other significant figurative elements, namely a bold curved dark line placed above a background circle in which the letter 'm' is almost included. These additional elements are of particular importance since the heavy bold line echoes the form of the background circle and the dark shade of the letter 'm', which is placed over the background. In the earlier mark, the letter 'm' appears in outline font with a characteristic inclination to the right and an uneven height so that the right-hand size of the letter is lower. Consequently, these dissimilarities between the signs are sufficient for it to be held that they do not give the consumer the same visual impression (para. 18).</p>		
Earlier sign	Contested sign	Case No
		04/10/2010, <a href="#">R 576/2010-2</a> ; confirmed 24/01/2012, <a href="#">T-593/10</a> , EU:T:2012:25
<p>G&amp;S: Classes 25, 41, 43</p> <p>Territory: Germany</p> <p><i>Assessment:</i> due to the different colours, figurative element and stylisation, the marks were found to be visually dissimilar. Visually, the earlier mark can be perceived as a boomerang, accompanied by the letter 'B', which is the first letter of 'boomerang'.</p>		

Earlier sign	Contested sign	Case No

		26/03/2021, <a href="#">R 551/2018-G</a>
<p>G&amp;S: Class 36</p> <p>Territory: France</p> <p><i>Assessment:</i> The signs have different colours, the left bars are of different sizes and have different ending points, and the contested sign contains a triangle overlapping the right bar which has no counterpart in the earlier sign. Even assuming that the signs were perceived as the stylised representation of the capital letter 'A', they are still visually dissimilar due to their different peculiar graphic stylisations (paras 54-56).</p>		

The above considerations also apply to signs consisting of single numbers.

Where 'one-letter/one-digit' signs are written out in letters, they are not considered equivalent to a sign where there is just a single element (e.g. 'ONE' is not equal to '1' or 'EM' to 'M'). Therefore, the abovementioned arguments are not directly applicable to such cases.

#### 3.4.1.8 Motion marks

The principles below have been agreed in the Common Communication on New Types of Marks: Examination of Formal Requirements and Grounds for Refusal ([CP11](#)).

A motion mark consists of, or extends to, a movement or a change in the position (and/or colour) of the verbal and/or figurative element of the mark.

When comparing two motion marks visually, the coincidence in or similarity between the elements in the signs (the verbal and/or figurative elements, and the movement or transformation of those elements) must be considered.



Motion marks can also be compared visually to other types of trade mark, with the exception of sound marks.

The verbal and/or figurative elements might appear only for a certain amount of time in the representation of the mark and then disappear or be transformed into another element. Elements that lead to similarity between the signs must appear for a sufficient amount of time to enable consumers to perceive/recognise them.



#### **Verbal elements**

A motion mark containing a distinctive **verbal element** is likely to be visually similar to another motion mark which contains the same or a similar distinctive verbal element. A distinctive verbal element in a motion mark can have a stronger impact on the

consumer than other visual elements (e.g. figurative elements, movement or transitions), although the comparison must consider the signs as a whole.

Earlier sign (motion mark)	Contested sign (motion mark)	Case No
 <a href="#">Link</a>	 <a href="#">Link</a>	Invented example (CP11)
<p>G&amp;S: Class 25</p> <p>Territory: EU</p> <p><i>Assessment:</i> The motion marks coincide in the distinctive verbal element 'Gerivan', which is clearly recognisable in both marks. The signs are visually similar.</p>		



When two marks of different types (e.g. word, figurative, shape, multimedia) coincide in the same or similar distinctive verbal elements, in principle, the signs will be considered visually similar, even though a sound might also be included (e.g. in a multimedia mark).

Earlier sign (motion mark)	Contested sign (multimedia mark)	Case No
 <a href="#">Link</a>	 <a href="#">Link</a>	Invented example (CP11)
<p>G&amp;S: Class 25</p> <p>Territory: EU</p> <p><i>Assessment:</i> The earlier motion mark and the contested multimedia mark contain a visual element that consists of the verbal element 'Gerivan' following this sequence: GE-RI-VAN Gerivan, and identical colours. Although the speed at which the letters appear is different, the marks are visually similar.</p>		

### **Figurative elements**

Coincidence or similarity in a distinctive **figurative element** can also lead to a finding of a degree of visual similarity between the signs. This will be the case especially if the coinciding or similar figurative element is separately recognisable or has the same or a similar contour.

In such a case similarity is likely to be found, in particular, when, due to its size or position within the mark and/or colour, consumers will perceive the figurative element to a sufficient extent, considering, in particular, that it moves/transforms.

Earlier sign (motion mark)	Contested sign (motion mark)	Case No
 <p><a href="#">Link</a></p>	<p>GERIVAN</p>  <p><a href="#">Link</a></p>	<p>Invented example (<a href="#">CP11</a>)</p>
<p>G&amp;S: Class 25</p> <p>Territory: EU</p> <p>Assessment: Both marks contain the same figurative element with a similar motion. Therefore, even though the contested motion mark contains a distinctive verbal element, the marks are visually similar.</p>		

The coincidence in the same distinctive figurative element in motion and other types of trade marks (e.g. figurative, shape, multimedia ) may lead to a finding of a visual similarity between the signs, depending on whether or not there are other elements in the mark to distract attention from the distinctive figurative element.

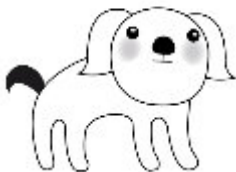
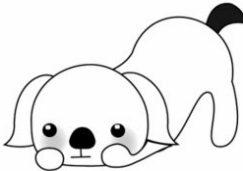
Earlier sign (figurative mark)	Contested sign (motion mark)	Case No
	 <p><a href="#">Link</a></p>	<p>Invented example (<a href="#">CP11</a>)</p>
<p>G&amp;S: Class 25</p> <p>Territory: EU</p> <p>Assessment: The signs share the same cartoon character of a dog. Therefore, they are visually similar even though the contested mark contains movement.</p>		

**The movement or transformation of elements**

A particular **movement** which is **striking and distinctive** could be sufficient to render motion marks visually similar to some extent even where they have other differing elements, such as verbal elements.

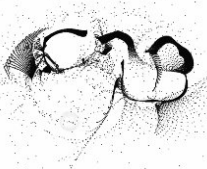
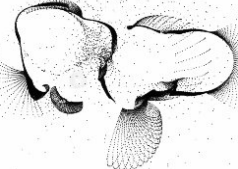
Earlier sign (motion mark)	Contested sign (motion mark)	Case No
 <p><a href="#">Link</a></p>	 <p><a href="#">Link</a></p>	<p>Invented example (<a href="#">CP11</a>)</p>
<p>G&amp;S: Class 25</p> <p>Territory: EU</p> <p>Assessment: Although the verbal elements are different in each mark, the marks are visually similar, given the coinciding striking movement and the similar graphic impression given by the cluster of pixels.</p>		

Apart from the movement of elements, motion marks may also consist of any other **transformation of elements**, such as a change in colours or a transformation of one element into another. These changes should be taken into account when assessing visual similarity of trade marks.

The mere coincidence in the change of position or change of colours in itself will usually have a lower impact on the outcome of the comparison of the marks, and will not, in principle, lead to a finding of visual similarity.

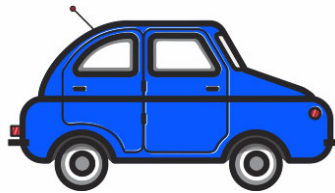
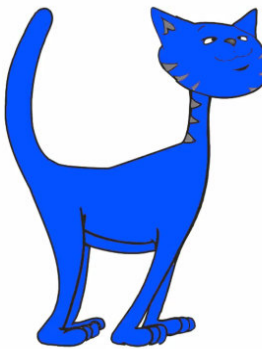
Earlier sign (motion mark)	Contested sign (motion mark)	Case No
 <p><a href="#">Link</a></p>	 <p><a href="#">Link</a></p>	<p>Invented example (<a href="#">CP11</a>)</p>



G&S: Class 25

Territory: EU

*Assessment:* The coinciding colour changing sequence does not outweigh the impact of the different figurative elements in the marks. Therefore, the marks are visually dissimilar.

### 3.4.1.9 Multimedia marks

The principles below have been agreed in the Common Communication on New Types of Marks: Examination of Formal Requirements and Grounds for Refusal ([CP11](#)).

Multimedia marks consist of, or extend to, the combination of visual elements (graphically depicted verbal elements, figurative elements and movement or transformation of the verbal and/or figurative elements) and sound elements (sung or spoken verbal elements, musical elements, true-to-life sounds and other sounds).

The interaction between the visual and sound elements and the possible impact that one has on the other may influence the comparison between the signs.

Multimedia marks can always be compared visually to other multimedia marks. The principles for the visual comparison of motion marks generally apply. Similarly, multimedia marks can be compared visually to other types of marks except sound marks.

#### **Graphically depicted verbal elements**



In principle, there is a degree of visual similarity between two multimedia marks or between a multimedia mark and a different type of mark (e.g. word, figurative, shape, hologram ) where they share the same or similar distinctive graphically depicted verbal elements (static or subject to motion).

Earlier sign (word mark)	Contested sign (multimedia mark)	Case No
BANANA	 <a href="#">Link</a>	Invented example ( <a href="#">CP11</a> )

G&S: Class 25

Territory: EU



*Assessment:* The earlier word mark contains only one distinctive verbal element 'BANANA', whereas the contested multimedia mark consists of a video showing the verbal element 'banana' in motion and a sound. The coincidence in the distinctive verbal element 'banana' leads to a finding of visual similarity.

Earlier sign (figurative mark)	Contested sign (multimedia mark)	Case No
	 <p data-bbox="616 674 660 696"><a href="#">Link</a></p>	<p data-bbox="1043 546 1310 568">21/09/2020, <a href="#">B 3 071 595</a></p>
<p data-bbox="236 819 480 842">G&amp;S: Classes 9, 28,41</p> <p data-bbox="236 875 373 898">Territory: UK</p> <p data-bbox="236 931 1359 1077"><i>Assessment:</i> The earlier figurative mark coincides with the contested multimedia mark in the distinctive elements 'THUNDER BALL', which are clearly recognisable in both signs. The additional figurative elements, including the stylisation of verbal elements have a reduced visual impact. The signs are visually similar at least to a low degree.</p>		

### **Figurative elements**

In principle, there is a degree of visual similarity between two multimedia marks or between a multimedia mark and a different type of mark (e.g. figurative, shape, hologram) where they share the same or similar distinctive figurative elements (static or subject to motion).

Earlier sign (multimedia mark)	Contested sign (multimedia mark)	Case No

 <p><a href="#">Link</a></p>	 <p><a href="#">Link</a></p>	<p>Invented example (<a href="#">CP11</a>)</p>
<p>G&amp;S: Class 25</p> <p>Territory: EU</p> <p><i>Assessment:</i> Both multimedia marks contain an identical depiction of a cow's face with an open mouth. Even though they have different (graphically depicted) verbal elements, they are visually similar.</p>		

### 3.4.2 Phonetic comparison

When the opposition is based on earlier signs that enjoy protection in different EU Member States, in principle, account must be taken of all the different pronunciations of the signs by the relevant public in all official languages of those Member States. Local accents are not taken into account. Nevertheless, as already mentioned, when the earlier mark is an EUTM registration, the analysis must in principle extend to the **whole** EU. However, where there is a likelihood of confusion for a part of the EU **and** it is justifiable for reasons of economy of procedure (such as to avoid examining specific pronunciations or meanings of marks in several languages), the Office's analysis need not extend to the whole EU but may instead focus on only a **part or parts** where there is a likelihood of confusion.



The overall phonetic impression produced by a sign is particularly influenced by the number and sequence of its syllables. The common rhythm and intonation of signs play an important role in how signs are perceived phonetically. The *Collins English Dictionary* defines 'rhythm' as 'the arrangement of words into a more or less regular sequence of stressed and unstressed or long and short syllables'. 'Intonation' is defined as 'the sound pattern of phrases and sentences produced by pitch variation in the voice'.

Therefore, the key elements for determining the overall phonetic impression of a trade mark are the syllables and their particular sequence and stress. The assessment of common syllables is particularly important when comparing marks phonetically, as a similar overall phonetic impression will be determined mostly by those common syllables and their identical or similar combination.

The following are examples of phonetically **dissimilar** marks.

Earlier sign	Contested sign	Relevant territory	Case No
CLENOSAN	ALEOSAN	ES	28/03/2011, <a href="#">R 1669/2010-2</a>
GULAS	MARGULIÑAS	ES	12/04/2011, <a href="#">R 1462/2010-2</a>

The following are examples of phonetically similar/identical marks.

Earlier sign	Contested sign	Relevant territory	Case No (degree of similarity)
CAMEA	BALEA	EU	14/01/2015, <a href="#">T-195/13</a> , EU:T:2015:6 (low)
		PT: the part of the relevant public that has some knowledge of the English language will read and pronounce the earlier mark in the same way as the mark applied for insofar as the latter uses the English word 'forever' (para. 70). The marks at issue share the same ending 'ever'; the Board of Appeal did not err in finding that those marks were phonetically similar to an average degree for the part of the relevant public with no knowledge of the English language (para. 72).	16/01/2014, <a href="#">T-528/11</a> , EU:T:2014:10 (identity/average)

Earlier sign	Contested sign	Relevant territory	Case No (degree of similarity)
FEMARA		EU	12/02/2010, <a href="#">R 722/2008-4</a> (above average)
	FOR US	BX	16/09/2010, <a href="#">R 166/2010-1</a> (identity)
		DE	09/06/2010, <a href="#">R 1071/2009-1</a> (low)





### 3.4.2.1 Signs and elements in signs that must be assessed

The Office conducts a phonetic comparison when both trade marks can be pronounced or have a sound. Accordingly, a figurative mark without word elements cannot, by definition, be pronounced. At the very most, its visual or conceptual content can be described orally. In other words, purely figurative marks (i.e. those not containing any word element) are not subject to a phonetic assessment. The ‘meaning’ that the image evokes, or its ‘description’, will be assessed visually and conceptually.



In this respect, the Office follows the case-law established by the judgments of 07/02/2012, [T-424/10](#), *Éléphants dans un rectangle*, EU:T:2012:58, § 46; 08/10/2014, [T-342/12](#), *Star*, EU:T:2014:858, § 48; 30/09/2015, [T-364/13](#), *KAJMAN / Device of a crocodile et al.*, EU:T:2015:738, § 46; 25/11/2015, [T-320/14](#), *Device of two wavy black lines (fig.) / Device of wavy black link (fig.)*, EU:T:2015:882, § 45-46. The contrary position taken by the Court in the judgment of 07/05/2015, [T-599/13](#), *GELENKGOLD / FORM EINES TIGERS et al.*, EU:T:2015:262, § 65 cannot be considered as a prevailing trend until clarification is given by the Court of Justice.

The Office does not undertake an indirect phonetic comparison, based on the description or a meaning attributed to the image by the public, given that in most cases, it is difficult to define which description the public will attribute to a figurative element and that the comparison based on such a description would lead to a subjective and arbitrary outcome. Furthermore, if the phonetic comparison is based on a description of a figurative element or on its meaning, it will only repeat the outcome of the visual or conceptual comparison respectively, where these elements have already been assessed.

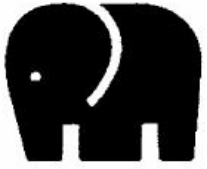
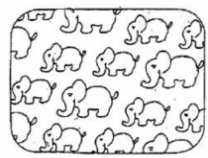
The following are examples of where no phonetic comparison could be made because the marks are purely figurative.

Earlier sign	Contested sign	Case No
		25/11/2015, EU:T:2015:882 <a href="#">T-320/14</a> ,
		08/10/2014, EU:T:2014:858 <a href="#">T-342/12</a> ,
		07/02/2012, EU:T:2012:58 <a href="#">T-424/10</a> ,

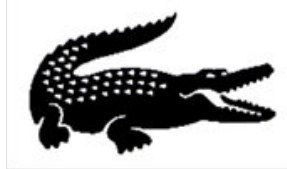
Furthermore, when one of the signs has elements that can be read and the other has only figurative elements, the two signs cannot be phonetically compared directly, as in the following examples.

Earlier sign	Contested sign	Case No
		30/09/2015, EU:T:2015:738 <a href="#">T-364/13</a> ,

Earlier sign	Contested sign	Case No
	 (KUNGFU)	17/11/2010, <a href="#">R 144/2010-2</a>

With regard to the pronunciation of figurative elements reminiscent of a letter, it should be noted that the relevant public will tend to read these figurative elements only when

they are linked to or form part of a word known to the relevant public, such as in the following examples.

Earlier sign	Contested sign	Case No
OLI SONE		16/04/2010, <a href="#">B 1 269 549</a>
ROCK		13/10/2009, <a href="#">T-146/08</a> , EU:T:2009:398

In the following case, however, the figurative element will not be recognised and read as 'X' and the contested sign read as 'be light'.

Earlier sign	Contested sign	Case No
BECKs		30/05/2013, <a href="#">T-172/12</a> , EU:T:2013:286

As a general rule, all word elements (including letters and numbers) are subject to the phonetic comparison. It may be the case, however, that the relevant public refers aurally to a sign by some elements and omits some words/letters.

For example, the relevant public may omit verbal elements that are clearly less prominent than ones that stand out visually, or are otherwise secondary in the overall impression given by the mark.

Furthermore, in its judgment of 03/07/2013, [T-206/12](#), LIBERTE american blend, EU:T:2013:342, the Court found that the public will not pronounce the words 'american blend' due to their **descriptive character**. In its judgment of 03/06/2015, in joined cases [T-544/12](#), PENSA PHARMA, EU:T:2015:355 and [T-546/12](#), pensa, EU:T:2015:355, the Court stated that consumers would not pronounce the word 'pharma', inasmuch as that word was superfluous because of the nature of the goods and services at issue.

Economy of language might be another reason for assuming that some elements will be pronounced while others will be omitted, particularly in case of very long marks (11/01/2013, [T-568/11](#), interdit de me gronder IDMG, EU:T:2013:5, § 44).

Finally, while words, letters and numbers should in principle be assessed phonetically, some symbols and abbreviations give rise to uncertainty.

For example, the logogram ‘&’ (ampersand) will generally be read and pronounced and therefore should be included in the phonetic comparison. However, the pronunciation of a given symbol may differ where different languages are concerned.

Earlier sign	Contested sign	Case No
	DNG	15/09/2010, <a href="#">R 160/2010-2</a>  The ampersand ‘&’ will be pronounced in most European Union languages and is recognised as the corresponding translation of the conjunction ‘and’.

The same goes for the typographic character @, which in principle will be pronounced. Obviously, the pronunciation of a given symbol may differ where different languages are concerned.

Earlier sign	Contested sign	Case No
	VODAFONE AT HOME	30/08/2010, <a href="#">R 138/2010-2</a>  @ will be pronounced as ‘at’ or ‘arobase’ in the Benelux (para. 21).

In the above case, it cannot be denied that a part of the relevant public — in particular English speakers — would read the ‘at’ symbol and thus pronounce the trade mark as ‘at home’. This possibility must, therefore, be taken into consideration, together with other possibilities such as ‘a home’ or simply ‘home’. Naturally, the symbol may be read in a different way in other languages (e.g. ‘arroba’ in Spanish and Portuguese).



However, compare this with the following examples.







Earlier sign	Contested sign	Case No
		03/02/2011, <a href="#">R 719/2010-1</a> ; dismissed 19/09/2012, <a href="#">T-220/11</a> , EU:T:2012:444;  dismissed 14/11/2013, <a href="#">C-524/12 P</a> , EU:C:2013:874  The @ will be perceived as the letter 'a' by (at least) the EN public (para. 25).
		20/07/2016, <a href="#">T-745/14</a> , EU:T:2016:423  The symbol '@' will easily be understood by the consumer as replacing the letter 'a' (para. 26).



The plus (+) and minus/hyphen (-) symbols may or may not be pronounced by the relevant public, depending on the circumstances. The minus symbol may be pronounced when used in combination with a number, for example, '-1', but it will not be pronounced if used as a hyphen (as in 'G-Star').

In the following examples, the symbol '+' in the contested EUTM application would be pronounced as 'plus'.

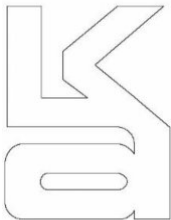
Earlier sign	Contested sign	Case No
AirPlus International		03/03/2010, <a href="#">T-321/07</a> , EU:T:2010:64;  dismissed 25/11/2010, <a href="#">C-216/10 P</a> , EU:C:2010:719
		16/09/2009, <a href="#">T-400/06</a> , EU:T:2009:331

However, sometimes the way in which symbols — or letters — are used makes it unrealistic to assume that they will be read and pronounced in a particular way, for example, when in a figurative mark a symbol is repeated in order to create a pattern or is highly distorted or when the letters/numbers are otherwise not clearly legible/identifiable. This is illustrated by the following examples.

Sign	Explanation
	<p>24/01/2012, <a href="#">T-593/10</a>, EU:T:2012:25</p> <p>In this figurative mark, the letter 'B' can be read. The mark must, therefore, be assessed phonetically.</p>
	<p>24/01/2012, <a href="#">T-593/10</a>, EU:T:2012:25</p> <p>In this figurative mark, the letter 'B' is so highly distorted that the Court found that for part of the public it is difficult to clearly identify if it is indeed the letter 'b' or the figure '8'.</p>
	<p>22/06/2011, <a href="#">R 1779/2010-4</a></p> <p>It is very difficult to determine the pronunciation of the sign. An aural comparison may, therefore, lead to very different results, ranging from identity to dissimilarity.</p>
	<p>28/01/2009, <a href="#">B 1 127 416</a></p> <p>In this figurative mark the letter 'H' can be read and, therefore, must be assessed phonetically.</p>
	<p>28/01/2009, <a href="#">B 1 127 416</a></p> <p>In this sign, the pattern makes it unlikely that consumers will read an 'H' (or rather several 'H's). This mark cannot be assessed phonetically.</p>



Sign	Explanation
	<p>16/10/2013, <a href="#">T-282/12</a>, EU:T:2013:533</p> <p>The Court held that, although hardly legible at first sight, the words 'FREE' and 'STYLE' in both of the signs are pronounced identically regardless of the language of the public.</p>
	<p>30/11/2017, <a href="#">T-475/16</a>, EU:T:2017:856</p> <p>The General Court held that it was not likely that the public would detect the letter 'y' in the figurative element of the mark. First, there is a great difference between the letter 'y' and the heart symbol. Second, the heart symbol is not usually used to replace the letter 'y'.</p>

In summary, whether or not a given symbol/letter is pronounceable depends on the type of character in question, how it is depicted, and how it is combined with other elements of the sign.

#### 3.4.2.2 Identical/similar sounds in different order

Where the opposing trade marks are formed of syllables or words that are identical or highly similar but in a different order, so that if just one of the syllables or words were rearranged the signs would be identical or highly similar phonetically, the conclusion should be that the signs are phonetically similar.

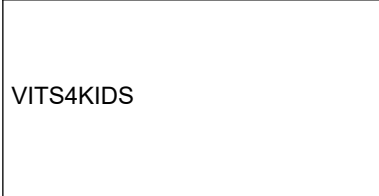
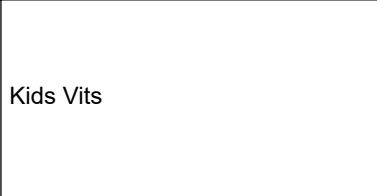
#### Examples

Earlier sign	Contested sign	Case No (degree of similarity)
		<p>09/12/2009, <a href="#">T-484/08</a>, EU:T:2009:486; § 33 dismissed 22/10/2010, <a href="#">C-84/10 P</a>, EU:C:2010:628</p>
		<p>11/06/2009, <a href="#">T-67/08</a>, EU:T:2009:198, § 39</p>

## 3.4.2.3 Signs consisting of or including foreign or invented words

When a sign contains foreign words, it should be assumed in principle that the relevant public is unfamiliar with how foreign native speakers pronounce their own language. Accordingly, the public will tend to pronounce a foreign word in accordance with the phonetic rules of their own language.

Earlier sign	Contested sign	Case No
LIDL	LIFEL	19/10/2010, <a href="#">R 410/2010-1</a>  The first two letters and the last one are the same in both marks. Aurally, the similarity is even stronger because LIDL will often be pronounced as if spelt LIDEL. For phonological reasons, 'D' and 'L' are nearly impossible to pronounce in most languages without inserting a vowel between them. Therefore, the marks would be pronounced LIFEL and LIDEL in languages like French, German, Italian and Spanish.
KAN-OPHTAL PAN-OPHTAL	BAÑOFTAL	12/07/2012, <a href="#">T-346/09</a> , EU:T:2012:368  The relevant territory is Germany. The Court found a phonetic similarity. The German consumer will probably pronounce the letters 'N' and 'Ñ' in the same way. Moreover, the letters 'P' and 'B' are pronounced with both lips and their sound can be confused if they are accompanied by the same vowel; the signs PAN-OPHTAL and BAÑOFTAL are aurally very similar.

GLANZ	GLÄNSA	13/07/2011, <a href="#">T-88/10</a> , EU:T:2011:368  The GC concluded that the umlaut would not alter the overall phonetic impression for EN, ES and FR speakers, since the languages in question do not have the letter 'ä' (para. 40).
-------	--------	---

However, this will not be the case when the relevant public is familiar with a word, for example in the following scenarios.

- When it is an established fact that a foreign language is known by the relevant public. For example, the Court has already confirmed that there is at least a basic understanding of the English language by the general public in the Scandinavian countries, the Netherlands and Finland (26/11/2008, [T-435/07](#), New Look, EU:T:2008:534, § 23).
- When certain terminology is clearly known by the relevant public for certain classes of goods and/or services. For example, IT professionals and scientists are generally considered to be more familiar with the use of technical and basic English vocabulary than the average consumer, irrespective of territory (27/11/2007, [T-434/05](#), Activy Media Gateway, EU:T:2007:359, § 38, 48 for the IT field (11/12/2008, [C-57/08 P](#), EU:C:2008:718, dismissed); 09/03/2012, [T-207/11](#), Isense, EU:T:2012:121, § 21-22 for German professionals in the medical field).
- When very basic words will be understood in all Member States, such as the English words 'baby', 'love', 'one', 'surf', the Italian word 'pizza', etc.

Earlier sign	Contested sign	Case No
Babylove Baby Love		08/07/2011, <a href="#">R 883/2010-2</a>

- Finally, when any one of the parties provides compelling evidence that a word is known by a significant portion of the relevant public.

Where a significant part of the relevant public pronounces the foreign word correctly, but another significant part applies the rules of their mother tongue, any assessment of phonetic similarity should mention both pronunciations and provide reasoning.



Earlier sign	Contested sign	Case No
WRITE	RIGHT	(example only) English: highly similar aurally Spanish: dissimilar aurally
	ZIRH	03/03/2004, <a href="#">T-355/02</a> , EU:T:2004:62; dismissed 23/03/2006, <a href="#">C-206/04 P</a> , EU:C:2006:194 Similar in English-speaking countries and Spain.

As regards **invented or fanciful words** (words that do not correspond to any existing word in the EU), the relevant consumer might pronounce them not only as they would sound according to the rules of pronunciation of their mother tongue but also as they are written.



Earlier sign	Contested sign	Case No
BAMIX	KMIX	21/02/2013, <a href="#">T-444/10</a> , EU:T:2013:89  The GC noted that the word element 'kmix' does not correspond to any existing word in the European Union and that it may be pronounced by part of the relevant public as it is written, as a single syllable. However, it also considered it possible that the mark applied for would be pronounced as a two-syllable word, namely 'ka' and 'mix'. In certain languages of the European Union (in particular French and German), the letter 'k' is pronounced as 'ka' and the pronunciation 'km' is not usual (para. 32).

## 3.4.2.4 Single letter signs

Non-stylised or minimally stylised single letters will allow the relevant public to identify the letter instantly and refer to it without any effort, thus, resulting in a **phonetic identity** for the same letters of the alphabet.

Earlier sign	Contested sign	Case No
		13/07/2004, <a href="#">T-115/02</a> , EU:T:2004:234, § 22

However, where the graphic stylisation of signs perceived as single letters is such that it makes it unrealistic to believe that the relevant public would refer to them orally (e.g. because the stylisation is too complex or conveys a distinct meaning that is difficult to describe orally), then the signs **cannot be compared phonetically**. The same outcome applies if only one of the marks will not be referred to aurally.

Earlier sign	Contested sign	Case No
		26/03/2021, <a href="#">R 551/2018-G</a> , § 60-61

## 3.4.2.5 Sound Marks

The principles below have been agreed in the Common Communication on New Types of Marks: Examination of Formal Requirements and Grounds for Refusal ([CP11](#)).



Sound marks consist exclusively of a sound or combination of sounds. These sounds encompass different elements that can be classified as follows: **sounds consisting of musical elements** (such as melody, harmony, rhythm); **true-to-life sounds**, such as the sound of a dog barking, thunder, ice cubes clinking; **sung or spoken verbal elements**; **other sounds** contained in a sound mark that are not covered by any of the above. Moreover, sound marks may encompass combinations of any of the above.



Aural comparison is decisive for sound marks. Sound marks can always be aurally compared to other sound marks and to multimedia marks. Sound marks can be aurally compared to other types of marks provided that those marks consist of or contain a verbal element (e.g. word, figurative or shape marks).

**Musical elements**

The presence of a distinctive melody in a sound mark has a considerable impact on the way the relevant public perceives the mark, and therefore substantially influences the aural comparison.



As a general rule, a different instrument, tempo or rhythm will not prevent two marks from being found similar, provided that the melody itself, being a rhythmic succession of notes, is identical or can be identified as being the same melody.

Earlier sign (sound mark)	Contested sign (sound mark)	Case No
 <a href="#">Link</a>	 <a href="#">Link</a>	Invented example (CP11)
<p>G&amp;S: Class 25</p> <p>Territory: EU</p> <p>Assessment: Both marks consist of the same distinctive melody. Therefore, they are aurally similar even though they are played on two different instruments.</p>		



Earlier sign (sound mark)	Contested sign (sound mark)	Case No
 <a href="#">Link</a>	 <a href="#">Link</a>	Invented example (CP11)
<p>G&amp;S: Class 25</p> <p>Territory: EU</p> <p>Assessment: Both sound marks consist of the same distinctive melody. Therefore, they are aurally similar even though they are played in two different tempos.</p>		

With reference to the above example, two melodies are similar when they contain variations which are not capable of significantly modifying the overall phonetic impression.



Earlier sign (sound mark)	Contested sign (sound mark)	Case No
 <a href="#">Link</a>	 <a href="#">Link</a>	Invented example (CP11)
G&S: Class 25 Territory: EU Assessment: Despite the variation in the melody in the contested mark, both marks are aurally similar.		

Nevertheless, two marks containing different melodies performed on the same instrument are normally not aurally similar.

Earlier sign (sound mark)	Contested sign (sound mark)	Case No
 <a href="#">Link</a>	 <a href="#">Link</a>	Invented example (CP11)
G&S: Class 25 Territory: EU Assessment: The distinctive melodies in the marks are different. The fact that they are played on the same instrument cannot make the marks aurally similar. The marks are aurally dissimilar.		

The coincidence or similarity in a distinctive melody usually has a considerable impact on the result of the aural comparison of the marks, even if one of the signs also contains a verbal element or both of them contain a different verbal element. Therefore, coincidence or similarity in the melody is more likely to lead to a finding of aural similarity to a certain extent, depending, inter alia, on the degree of distinctiveness of the melody and the verbal element.



Earlier sign (sound mark)	Contested sign (sound mark)	Case No
 <a href="#">Link</a>	 <a href="#">Link</a>	Invented example (CP11)

G&S: Class 25

Territory: EU

*Assessment:* Even though the verbal elements and voices of each mark are different, the coincidence in the same distinctive melody makes the marks aurally similar.

Due to the nature of the different types of trade mark, the possibility of coincidence in the melody only exists for multimedia marks, as they are the only other type of trade mark containing sound.

Earlier sign (sound mark)	Contested sign (multimedia mark)	Case No
 <p><a href="#">Link</a></p>	 <p><a href="#">Link</a></p>	<p>Invented example (<a href="#">CP11</a>)</p>

G&S: Class 25

Territory: EU



*Assessment:* Both marks contain the same distinctive melody and voice. Therefore, as there are no additional sound elements, the marks are aurally identical.



### **True-to-life sounds**

Aural similarity of true-to-life sounds is assessed by taking into account the same elements and aspects as previously discussed (tone, rhythm or other aspects).

Coincidence in or similarity of distinctive true-to-life sounds, in sound or multimedia marks, generally leads to a finding of aural similarity. The similarity will depend on, among other aspects, whether there are other distinctive elements present in one of the marks or in both marks.

Earlier sign (sound mark)	Contested sign (sound mark)	Case No
---------------------------	-----------------------------	---------



 <a href="#">Link</a>	 <a href="#">Link</a>	Invented example (CP11)
G&S: Class 25 Territory: EU Assessment: Both sound marks consist exclusively of the sound of a dog or dogs barking. Therefore, as the barking of the dogs sounds similar, the marks are aurally similar to a certain extent.		



Earlier sign (sound mark)	Contested sign (sound mark)	Case No
 <a href="#">Link</a>	 <a href="#">Link</a>	Invented example (CP11)
G&S: Class 25 Territory: EU Assessment: Both sound marks consist exclusively of the sound of birds. Nevertheless, the sounds these birds make are so different that they make the marks aurally dissimilar.		

### **Verbal elements**

In principle, both verbal and non-verbal elements in sound marks can have a considerable impact on the relevant public's perception of the sign. In particular, the presence of a distinctive verbal element in a sound mark usually significantly influences the relevant public's perception. According to case-law, where composite marks contain verbal and figurative elements, it is usually the verbal element that has a greater impact on the consumer's aural perception. This concept also applies, in principle, to sound marks containing sung or spoken words. For this reason, the coincidence or the similarity in a distinctive verbal element makes it more likely to lead to a finding of aural similarity to a certain extent.

Earlier sign (sound mark)	Contested sign (sound mark)	Case No

		Invented example ( <a href="#">CP11</a> )
<a href="#">Link</a>	<a href="#">Link</a>	
<p>G&amp;S: Class 25</p> <p><i>Territory:</i> EU</p> <p><i>Assessment:</i> The sound marks have different voices and intonations. The earlier sign is a sung word, whereas the contested sign is a spoken word. However, the coincidence in the distinctive verbal element 'Gerivan' makes the marks aurally similar.</p>		

Earlier sign (sound mark)	Contested sign (sound mark)	Case No
		Invented example ( <a href="#">CP11</a> )
<a href="#">Link</a>	<a href="#">Link</a>	
<p>G&amp;S: Class 25</p> <p><i>Territory:</i> EU</p> <p><i>Assessment:</i> The verbal elements at the beginning of both sound marks and the voices are different, and one of the marks does not feature any melody. However, the marks coincide in the distinctive verbal element 'Gerivan', which can be heard and recognised in both marks. The marks are therefore aurally similar.</p>		

However, two sound marks can still be similar if the verbal elements are different but the signs coincide in another distinctive aspect, especially in a melody.

Earlier sign (sound mark)	Contested sign (sound mark)	Case No
		Invented example ( <a href="#">CP11</a> )
<a href="#">Link</a>	<a href="#">Link</a>	

G&S: Class 25

*Territory:* EU

*Assessment:* Even though the verbal elements and voices of each mark are different, the coincidence in the same distinctive melody makes the marks aurally similar.

Furthermore, if two sound marks share a word that a significant part of the relevant public can identify as the same or a similar distinctive word, even if pronounced according to the pronunciation rules of two different languages/in two different voices/in two different accents, they may, in principle, still be aurally similar.

Earlier sign (sound mark)	Contested sign (sound mark)	Case No
 <a href="#">Link</a>	 <a href="#">Link</a>	Invented example ( <a href="#">CP11</a> )

G&S: Class 25

*Territory:* EU



*Assessment:* Although the marks are pronounced in different voices and according to pronunciation rules of two different languages, there is still an aural similarity because a significant part of the public will identify a similar distinctive word.

When comparing sound marks with verbal elements to other types of marks with verbal elements, the coincidence in or similarity between distinctive verbal elements, if identified as such by a significant part of the relevant public, will, in principle, lead to a finding of aural similarity. The way the verbal element is reproduced has to be taken into account. This means that while the pronunciation of a word mark is determined by the pronunciation rules of the relevant public, this is not so in the case of a sound mark, where the aural perception is determined by how the mark sounds.

### **Other aspects**

The mere coincidence in other aspects such as intonation and voice usually has a low impact on the aural comparison of the marks, even if those aspects contribute to a certain degree to the mark's distinctive character.

Earlier sign (sound mark)	Contested sign (sound mark)	Case No
---------------------------	-----------------------------	---------



 <a href="#">Link</a>	 <a href="#">Link</a>	Invented example (CP11)
G&S: Class 25 Territory: EU Assessment: The marks are composed of two different distinctive words (Gerivan and Banana) pronounced in the same voice and intonation. The latter factor is not enough to find the marks aurally similar.		

### 3.4.2.6 Motion marks

The principles below have been agreed in the Common Communication on New Types of Marks: Examination of Formal Requirements and Grounds for refusal (CP11).

Only motion marks containing perceptible verbal elements that can be compared aurally with the same or other types of marks provided that the other mark also contains perceptible verbal elements. The general criteria for comparing word marks or composite marks (containing both verbal and figurative elements) are applicable.

An overlap or similarity in a distinctive verbal element will usually lead to similarity in the aural comparison between motion marks or a motion mark and another type of mark.

Earlier sign (motion mark)	Contested sign (figurative mark)	Case No
 <a href="#">Link</a>		Invented example (CP11)

G&S: Class 25

Territory: EU



*Assessment:* The signs coincide in the distinctive verbal element ‘Gerivan’, which will be identically pronounced in both marks. The signs are aurally identical.

Earlier sign (sound mark)	Contested sign (motion mark)	Case No
 <a href="#">Link</a>	 <a href="#">Link</a>	Invented example (CP11)

G&S: Class 25

Territory: EU



*Assessment:* The signs coincide in the sequence: E-RI-VAN and differ only in the first letters G and B. The pronunciation is similar for the English-speaking public. Therefore, the marks are aurally similar.

Earlier sign (motion mark)	Contested sign (multimedia mark)	Case No Earlier sign (motion mark)
 <a href="#">Link</a>	 <a href="#">Link</a>	Invented example (CP11)

G&S: Class 25

Territory: EU

*Assessment:* The signs contain the distinctive verbal element ‘Gerivan’. Moreover, the sound of the contested multimedia mark consists of the same verbal element, ‘Gerivan’, being pronounced. Therefore, the marks are aurally at least highly similar.

Earlier sign (motion mark)	Contested sign (motion mark)	Case No
 <p><a href="#">Link</a></p>	 <p><a href="#">Link</a></p>	<p>Invented example (<a href="#">CP11</a>)</p>
<p>G&amp;S: Class 25</p> <p>Territory: EU</p> <p><i>Assessment:</i> Both motion marks consist of different distinctive verbal elements, namely ‘FRED’ and ‘Gerivan’. Therefore, the marks are aurally dissimilar.</p>		

### 3.4.2.7 Multimedia marks

The principles below have been agreed in the Common Communication on New Types of Marks: Examination of Formal Requirements and Grounds for Refusal ([CP11](#)).



Multimedia marks can always be compared aurally to other multimedia marks and sound marks. An aural comparison can also be made with other types of marks if they contain a verbal element.



All the different types of **sound elements** (musical elements, true-to-life sounds, sung or spoken verbal elements and other sounds) and the **graphically depicted verbal elements** must be considered in the aural comparison.

#### **Graphically depicted verbal elements**

In principle, there is a degree of aural similarity if a multimedia mark contains a distinctive graphically depicted verbal element (static or subject to motion) that coincides in, or is similar to, a verbal element of another mark (whether sung or spoken or graphically depicted).





Earlier sign (multimedia mark)	Contested sign (multimedia mark)	Case No
 <a href="#">Link</a>	 <a href="#">Link</a>	Invented example ( <a href="#">CP11</a> )
<p>G&amp;S: Class 25</p> <p>Territory: EU</p> <p><i>Assessment:</i> Both signs contain the distinctive verbal element 'Gerivan'. Therefore, although the melodies (and instruments) are different, they are aurally similar.</p>		



Earlier sign (sound mark)	Contested sign (multimedia mark)	Case No
 <a href="#">Link</a>	 <a href="#">Link</a>	Invented example ( <a href="#">CP11</a> )
<p>G&amp;S: Class 25</p> <p>Territory: EU</p> <p><i>Assessment:</i> The verbal element in the earlier sound mark is spoken and in the contested multimedia mark it is graphically depicted. Since the relevant English-speaking public will pronounce the graphically depicted element in the multimedia mark similarly to how the earlier trade mark sounds, the marks are aurally similar.</p>		

### **Sung or spoken verbal elements**

In principle, there is a degree of aural similarity if the sung or spoken verbal element of the multimedia mark coincides in, or is similar to, another verbal element perceived in another mark (whether sung or spoken or graphically depicted).

Earlier sign (multimedia mark)	Contested sign (multimedia mark)	Case No

 <p><a href="#">Link</a></p>	 <p><a href="#">Link</a></p>	<p>Invented example (<a href="#">CP11</a>)</p>
<p>G&amp;S: Class 25</p> <p>Territory: EU</p> <p><i>Assessment:</i> The signs coincide in the distinctive verbal element 'Gerivan'. Therefore, despite the difference in the pronunciation, intonation and voice of that verbal element, which is spoken in the earlier mark and sung in the contested mark, the marks are aurally similar.</p>		



Earlier sign (motion mark)	Contested sign (multimedia mark)	Case No
 <p><a href="#">Link</a></p>	 <p><a href="#">Link</a></p>	<p>Invented example (<a href="#">CP11</a>)</p>
<p>G&amp;S: Class 25</p> <p>Territory: EU</p> <p><i>Assessment:</i> In the earlier motion mark, the word 'Gerivan' is graphically depicted, in the contested multimedia mark it is only sung. The sound of the verbal elements in both signs is similar according to English pronunciation. The marks are aurally similar.</p>		

**Combination of graphically depicted and sung or spoken verbal elements**

As stated above, multimedia marks can contain both sung or spoken and graphically depicted verbal elements. In such cases, both the sung or spoken and graphically depicted verbal elements must be considered in the aural comparison.



Moreover, where a graphically depicted verbal element is accompanied by a sung or spoken verbal element, the latter could affect the pronunciation of the graphically depicted verbal element. However, depending on the particular case, it cannot be excluded that the graphically depicted verbal element in a multimedia mark would still be pronounced according to the pronunciation rules of the corresponding relevant public.



Earlier sign (word mark)	Contested sign (multimedia mark)	Case No
GERIVAN	 <a href="#">Link</a>	Invented example ( <a href="#">CP11</a> )
<p>G&amp;S: Class 25</p> <p>Territory: EU</p> <p><i>Assessment:</i> The signs coincide in the verbal element 'Gerivan'. However, in the earlier word mark it is pronounced according to English rules, whereas the contested multimedia mark is pronounced in Spanish. In this case, the possibility that the English-speaking public might pronounce the verbal element in the contested mark according to English pronunciation rules must be considered, even though the contested mark contains the sound of 'Gerivan' pronounced in Spanish. The marks are aurally similar.</p>		

Earlier sign (figurative mark)	Contested sign (multimedia mark)	Case No
	 <a href="#">Link</a>	21/09/2020, <a href="#">B 3 071 595</a>
<p>G&amp;S: Classes 9, 28,41</p> <p>Territory: UK</p> <p><i>Assessment:</i> The signs coincide in the pronunciation of the verbal elements 'THUNDER BALL' in the earlier mark and the graphically depicted verbal elements 'THUNDER BALL' combined with the sound representation of the same elements in the contested multimedia mark. The signs differ in the sound of a melody in the background, the swooshing, zapping and the thunder sounds and the additional sounds in the contested sign. The signs are aurally similar to a high degree.</p>		

**Musical elements and true-to-life sounds**

The possibility of coincidence in a melody or true-to-life sounds only exists with multimedia and sound marks, as they are the only types of trade mark that may contain such sounds.



Earlier sign (multimedia mark)	Contested sign (multimedia mark)	Case No
 <p><a href="#">Link</a></p>	 <p><a href="#">Link</a></p>	<p>Invented example (<a href="#">CP11</a>)</p>
<p>G&amp;S: Class 25 Territory: EU Assessment: Both marks coincide in the same distinctive melody. Although both multimedia marks contain different figurative elements, those elements do not affect the aural comparison. Therefore, the marks are aurally identical.</p>		

Earlier sign (sound mark)	Contested sign (multimedia mark)	Case No
 <p><a href="#">Link</a></p>	 <p><a href="#">Link</a></p>	<p>Invented example (<a href="#">CP11</a>)</p>

G&S: Class 25

*Territory:* EU

*Assessment:* Both marks coincide in the same distinctive melody. Although the contested multimedia mark also contains a graphically depicted verbal element and a figurative element, the marks are aurally similar.

Earlier sign (multimedia mark)	Contested sign (multimedia mark)	Case No
 <p><a href="#">Link</a></p>	 <p><a href="#">Link</a></p>	<p>Invented example (<a href="#">CP11</a>)</p>

G&S: Class 25

*Territory:* EU

*Assessment:* Both marks coincide in the same distinctive melody. Although the marks also contain graphically depicted verbal elements whose phonetic perception will be different, the marks are aurally similar.

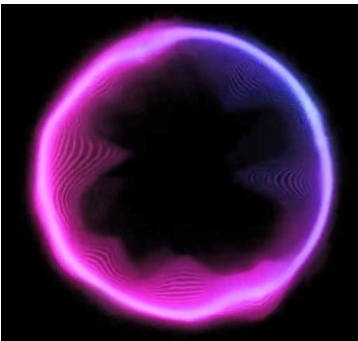
Earlier sign (sound mark)	Contested sign (multimedia mark)	Case No
 <p><a href="#">Link</a></p>	 <p><a href="#">Link</a></p>	<p>Invented example (<a href="#">CP11</a>)</p>

G&S: Class 25

Territory: EU

*Assessment:* Both marks coincide in the same true-to-life sound. Therefore, the marks are aurally identical.

### 3.4.3 The semantic content of marks

Two signs are identical or similar conceptually when they are perceived as having the same or analogous semantic content (11/11/1997, [C-251/95](#), Sabèl, EU:C:1997:528, § 24). The ‘semantic content’ of a mark is what it means, what it evokes or, when it is an image or shape, what it represents. In this text the expressions ‘semantic content’ and ‘concept’ will be used indiscriminately.

A ‘concept’ may be defined as ‘a principle or idea’ or ‘an idea, theory, etc. about a particular subject’, or as ‘an idea or a principle that is connected with something abstract’ (26/03/2021, [R 551/2018-G](#), Device (fig.) / Device (fig.), § 75).

If a mark consists of various elements (e.g. a word and a figurative element) the concept of each of the elements must be defined. However, if the mark is a meaningful expression (made up of two or more words), what matters is the meaning of the expression as a whole and not of each of the words in isolation.

Not every concept has to be defined: only those concepts likely to be known by the relevant public, as defined by the relevant territory, matter. For example, if the relevant territory is Spain, the fact that the word has a meaning in Polish is normally irrelevant.

The conceptual comparison may be influenced by the relevant goods and services. For example, if a term has many meanings, one of which is of particular significance to the relevant goods and services, the conceptual comparison may focus on this meaning. In any event, what matters is how the term is perceived by the relevant public. A link between the goods and services and what the sign means, evokes or represents must not be forced or artificially constructed. For example, if the relevant goods relate to *lighting* and the sign is or contains the element ‘LED’, ‘light-emitting diode’ is one of the various possible meanings of ‘LED’. Therefore, the conceptual comparison may focus on this meaning.

#### 3.4.3.1 The semantic content of words

When the mark consists of or contains a word, the first step for an examiner is to look up the explanation of that word in dictionaries and/or encyclopaedias in the language(s) of the relevant territory. If the word is in the dictionary/encyclopaedia, the described meaning will be its semantic content.

As a starting point, it should be noted that the relevant public in the various EU Member States mainly speak the languages predominant in their respective territories

(23/10/2002, [T-6/01](#), Matratzen + Matratzenmarkt Concord (fig.), EU:T:2002:261, § 27). These languages are normally the official languages of the relevant territory.



Earlier sign	Contested sign	Case No
HALLOUMI	HELLIM	13/06/2012, <a href="#">T-534/10</a> , EU:T:2012:292
<p>'Hellim' is the Turkish translation of 'Halloumi' (Greek) (a type of cheese). The relevant territory was Cyprus. The Court held that while Turkish is not an official language of the EU, it is one of the official languages of the Republic of Cyprus. Thus, Turkish is understood and spoken by part of the population of Cyprus (para. 38).</p> <p>Therefore, the Court found that the average consumer in Cyprus, where both Greek and Turkish are official languages, will understand that the words HALLOUMI or HELLIM both refer to the same specialty cheese from Cyprus. Consequently, there is some conceptual similarity between these words (para. 41).</p>		

However, the Court has made it equally clear that this rule only concerns the primary linguistic understanding of the public in those territories. This is not an inflexible rule. The relevant public should not automatically be considered as having as its mother tongue the language that is predominant in the Member State concerned, or to have no particular knowledge of other languages (03/06/2009, [C-394/08 P](#), Zipcar / CICAR, EU:C:2009:334, § 51).

For instance, in the following scenarios, languages other than the predominant one are to be taken into account.

- When the word in another language is very close to the equivalent word in the official language of the relevant territory. For example, the English word 'bicycle' will be understood in Spain because it is very close to the Spanish equivalent word, 'bicicleta'.
- When the word in a foreign language is commonly used in the relevant territory. For example, the Spanish word 'bravo' is commonly used as a term denoting praise, in the sense of 'well done' in Germany.
- When it is known that the relevant public is familiar with a foreign language. For example, the Court has already confirmed that the general public in the Scandinavian countries, the Netherlands and Finland, has at least a basic understanding of the English language (26/11/2008, [T-435/07](#), New Look, EU:T:2008:534, § 23).
- When it is known that the relevant public is familiar with a language for certain classes of goods and/or services. For example, English IT terms are normally understood by the relevant public for IT goods and services, irrespective of territory.
- Very basic words, which will be understood in all Member States because they have become internationally used, such as 'baby', 'love', 'one', 'surf', the Italian word 'pizza', etc.
- Finally, when any one of the parties submits evidence that a word is known by a relevant portion of the relevant public.

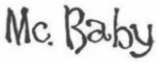
The following are **examples** of concepts behind words.

Sign	Territory	Concept	Case No
Mirto	ES	[in EN: myrtle] in Spanish describes a shrub of the family <i>Myrtaceae</i> , 2-3 m high.	19/03/2010, <a href="#">T-427/07</a> , Mirtillino, EU:T:2010:104
Storm	EN	Bad weather	08/07/2010, <a href="#">T-30/09</a> , EU:T:2010:298
 --- STAR SNACKS	EU	The terms 'star snacks' and 'star foods' will be understood as referring to quality food not only by English speakers, but also by most of the relevant public.	11/05/2010, <a href="#">T-492/08</a> (Star foods I), EU:T:2010:186 10/10/2012, <a href="#">T-333/11</a> (Star Foods II), EU:T:2012:536
 	EU	There is some degree of conceptual similarity, based on 'Mc' and the words 'baby' and 'kids' that both refer to children (para. 42).	05/07/2012, <a href="#">T-466/09</a> , EU:T:2012:346

As shown in some of the examples above, it is not always necessary to give a complete dictionary definition of what a word means. It is sufficient to use a synonym.

Additionally, when part of the public will perceive the concept while another part either will not or will perceive a different meaning, a distinction should be made accordingly.

When the mark conveys a **meaningful expression**, the meaning of the expression as a whole, as long as it is understood as such by the relevant public, and not that of the individual words, is the one that is relevant for the conceptual comparison (however, note the exception below concerning expressions in foreign languages). Therefore, individual assessment of each element of the mark should be avoided.

Fictional example: 'KING'S DOMAIN' v 'KING SIZE'.

**Incorrect assessment:** 'KING' means 'a male sovereign', 'DOMAIN' means 'a territory over which rule or control is exercised' and 'SIZE' means 'the physical dimensions, proportions, magnitude, or extent of an object'. The marks are conceptually similar insofar as they share the notion of 'king'.

**Correct assessment:** 'KING'S DOMAIN' means 'a territory under the control of a king'; 'KING SIZE' means 'larger or longer than the usual or standard size'. The marks are conceptually dissimilar even though they share the word 'KING'.



This is further illustrated by the following example from case-law:

Earlier sign	Contested sign	Case No
BLACK TRACK		06/03/2015, <a href="#">T-257/14</a> , EU:T:2015:141
<p>G&amp;S: Class 28</p> <p><i>Territory:</i> EU</p> <p><i>Assessment:</i> The English-speaking public will perceive the expression 'black jack' as a whole designating a card game and will not perceive the word 'black' independently within that expression. The expression constituting the earlier mark, 'black track', will also be perceived with its distinct meaning. Therefore, it cannot be held that the signs are conceptually similar just because they both contain the word 'black'. The signs are conceptually dissimilar (paras 38-42).</p>		

Furthermore, when the mark is composed of a noun and a qualifying adjective, in general it will be perceived as a conceptual unit and will not be broken down into its constituent elements.

Earlier sign	Contested sign	Case No
EAU PRECIEUSE	NUIT PRECIEUSE	12/09/2018, <a href="#">T-905/16</a> , EU:T:2018:527 (02/05/2019, <a href="#">C-739/18 P</a> , EU:C:2019:356, appeal dismissed)
<p>G&amp;S: Class 3</p> <p><i>Territory:</i> France</p> <p><i>Assessment:</i> The relevant public will clearly perceive the meaning of each of the signs at issue as a complete phrase containing a noun, 'nuit' and 'eau' respectively, with an identical qualifying adjective, namely 'précieuse'. While the first sign refers to the concept of water that is precious, the second refers to the idea of a cherished or esteemed night. Those are different concepts and, regard being had to their obvious meaning, the relevant public will not dissect those signs in order to distinguish each element of them (paras 62-64).</p>		

The abovementioned rule on meaningful expression has the following **exception**: when signs are in a foreign language, a significant part of the relevant public may have only a limited command of the relevant foreign language and, therefore, might not be able to distinguish the difference in meaning between two expressions. In these instances it may be that the meaning of an expression as such is not perceived; only the meanings of the individual elements. This may, therefore, lead to a finding of similarity insofar as the public understands only the common part. In the example above, if it is found that (part of the) public will only understand KING, the finding should be that the signs are conceptually similar.

Earlier sign	Contested sign	Case No
ICEBERG	ICEBREAKER	08/09/2010, <a href="#">T-112/09</a> , EU:T:2010:361
<p>The GC considered that 'icebreaker' would be understood only by that part of the Italian public with a command of the English language. However, 'iceberg' is a common word with an immediately obvious meaning to the relevant public. Therefore, the earlier mark ICEBERG will have a clear meaning for the Italian public, whereas the mark applied for ICEBREAKER would be devoid of any clear meaning for that public.</p> <p>The GC further indicated that the marks at issue have the prefix 'ice' in common. The GC considered that this is a basic English word, understandable for most of the relevant public. It concluded that since the prefix 'ice' had a certain evocative force, it must be regarded as limiting the conceptual difference between the marks at issue, acting as a 'semantic bridge' (paras 41-42).</p>		

Similar considerations apply to expressions that include a combination of technical words understood by only part of the relevant public (e.g. Latin words, words belonging to highly specialised language) and commonly used words. In these cases, it may be that only the meaning of the commonly used words is perceived, and not the meaning of the expression as such.

#### 3.4.3.2 The semantic content of parts of words



In this regard, the Court has held that, although the average consumer normally perceives a mark as a whole and does not proceed to analyse its various details, the fact remains that, when perceiving a word sign, they will break it down into elements which, for them, suggest a specific meaning or which resemble words known to them (13/02/2007, [T-256/04](#), *Respicur*, EU:T:2007:46, § 57).

Consequently, while the rule is that marks are perceived as a whole, the exception to the rule is that, under certain circumstances, consumers could break them down into smaller parts. Since this is an exception, it has to be applied restrictively.

It will be applied in the following cases.

- when a **visual separation** assists in identifying parts with a concept (e.g. through the use of lower- and upper-case letters, the stylisation of letters or the use of a special character separating the elements, such as a symbol, numeral, hyphen or other punctuation mark);
- when, without a visual separation, **all** the parts of the word suggest a concrete meaning known to the relevant public; or
- when, without a visual separation, **one** part of the word has a clear meaning.

i) Examples of signs where a visual separation assists in identifying parts.

Sign	Territory	Concept	Case No
	EU	The use of capital letters allows the sign to be separated immediately into two distinct words, namely 'invest' and 'hedge'.	11/06/2009, <a href="#">T-67/08</a> , EU:T:2009:198, § 35
VITS4KIDS	EU	The mark contains VITS (allusive of 'vitamins') and KIDS.	09/12/2009, <a href="#">T-484/08</a> , EU:T:2009:486
 	EU	AGRO: reference to agriculture HUN: reference to Hungary UNI: reference to universal or union.	24/03/2010, <a href="#">T-423/08</a> , EU:T:2010:116

ii) Examples of signs where, despite the absence of a visual separation, the single word can be broken down into parts, **all** of which suggest a concrete meaning known to the relevant public.

Sign	Territory	Concept	Case
Ecoblue	EU	The word element 'eco' is a common prefix or abbreviation in many languages spoken in the European Union, while the word 'blue' is English for the colour blue and part of the basic English vocabulary known to the relevant public.	12/11/2008, <a href="#">T-281/07</a> , EU:T:2008:489; dismissed 22/01/2010, <a href="#">C-23/09</a> <a href="#">P</a> , EU:C:2010:35
Solfrutta / FRUTISOL	EU	The elements 'sol' and 'fruit' are generally recognisable and can be understood as alluding to 'sun' and 'fruit' respectively.	27/01/2010, <a href="#">T-331/08</a> , EU:T:2010:23

Sign	Territory	Concept	Case
RIOJAVINA	EU	The term 'riojavina' in the mark applied for refers directly, so far as the relevant public is concerned, to grapevine products and, more particularly, Rioja wine.	09/06/2010, <a href="#">T-138/09</a> , EU:T:2010:226; Dismissed 24/03/2011, <a href="#">C-388/10</a> P, EU:C:2011:185

iii) Examples of signs where **one** part of the single word has a clear meaning. These are usually signs that include a common prefix or suffix.

Sign	Territory	Concept	Case No
	DE	'DERMA' may be perceived as referring to goods of a dermatological nature.	03/04/2009, <a href="#">B 1 249 467</a>
RNAiFect	EU	The relevant public, particularly the specialist public, will perceive the first three letters as a reference to the English abbreviation for ribonucleic acid.	28/10/2009, <a href="#">T-80/08</a> , EU:T:2009:416
nfon	EU	The relevant public will isolate the syllable 'fon' in the sign 'nfon', and perceive this term as relating equally to the words 'telephone' or 'phone.' (para. 60).	29/01/2013, <a href="#">T-283/11</a> , EU:T:2013:41; dismissed 16/01/2014, <a href="#">C-193/13 P</a> , EU:C:2014:35

As explained above, all three exceptions have to be construed narrowly; therefore, where it is not obvious that a part or parts suggest(s) a concrete meaning known to the relevant public, a sign should not be artificially dissected. In the examples below, no concept was found in the signs.



Sign	Territory	Concept	Case No
ATOZ	DE, ES, FR, IT, AT	The TM will not be perceived as 'from A to Z'. The letters 'to' (corresponding to an English preposition) do not stand out in any way from the letters 'a' and 'z'.	26/11/2008, <a href="#">T-100/06</a> , EU:T:2008:527; dismissed 16/09/2010, <a href="#">C-559/08</a> <a href="#">P</a> , EU:C:2010:529
SpagO	BX	The word 'SpagO' is an invented word that has no meaning in any of the official languages of Benelux countries. It should not be perceived as a combination formed by SPA + GO.	12/11/2009, <a href="#">T-438/07</a> , EU:T:2009:434
CITRACAL --- CICATRAL	ES	The word elements 'cica' and 'citra' do not have any concrete meaning, any more than the endings 'tral' and 'cal'. The signs at issue are, therefore, not likely to be broken down by the public into word elements that have a concrete meaning or resemble words known to it and that, together, would form a coherent whole giving a meaning to each of the signs at issue or to any one of them.	11/11/2009, <a href="#">T-277/08</a> , EU:T:2009:433

### 3.4.3.3 The semantic content of misspelt words

It is not necessary for a word to be written properly for its semantic content to be perceived by the relevant public. For example, while the written word 'XTRA' is visually not the same as the 'correct' word 'EXTRA', because it is aurally identical to it, the

concept of the ‘correct’ word (extra) will normally be transferred to the misspelt word (xtra).

The following examples illustrate this point.

Sign	Territory	Concept	Case
	EU	Part of the relevant public will regard it as a reference to the English word ‘store’, meaning ‘shop, storage’.	21/01/2010, <a href="#">T-309/08</a> , EU:T:2010:22
CMORE	EN	CMORE will, in view of the common practice of sending text messages, probably be associated by a significant part of the general public in Denmark and Finland with an abbreviation or misspelling of the verb ‘to see’ in English, with the concept being perceived as ‘see more’.	23/09/2011, <a href="#">T-501/08</a> , EU:T:2011:527,
	EN	The word ‘ugli’ in the earlier mark is likely to be associated with the English word ‘ugly’ by the relevant public.	15/04/2010, <a href="#">T-488/07</a> , EU:T:2010:145
	EU	The term contained in the mark will bring to consumers’ minds the idea of ‘yogurt’, i.e. ‘a semi-solid, slightly sour, food prepared from milk fermented by added bacteria’.	14/07/2009, <a href="#">B 1 142 688</a>

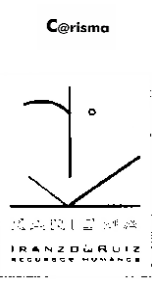
Sign	Territory	Concept	Case
	ES	The words 'KARISMA' and 'C@RISMA' refer to 'charisma' or 'charism', i.e. a special personal quality or power of an individual, making him or her capable of influencing or inspiring large numbers of people.	28/10/2008, <a href="#">B 1 012 857</a>

Examiners should take care when attaching meaning to a misspelt word: the meaning is not likely to be transferable when the words are not (aurally) identical and/or when the misspelt element cannot be perceived independently.

Sign	Territory	Concept	Case No
Bebimil	EU	The mark applied for does not contain the word 'baby' but a fanciful word, which is further removed and without any clear and specific meaning, i.e. 'bebi'.	16/09/2006, <a href="#">T-221/06</a> , EU:T:2009:330

#### 3.4.3.4 The semantic content of personal names

In line with the broad definition of a 'concept' ([paragraph 3.4.3](#)), a sign perceived as a **personal name has the concept** of a person (male or female) bearing that particular name, even if the name does not designate any well-known personality. A conceptual comparison between marks containing personal names that do not designate well-known personalities is therefore possible. This, however, is only relevant for the conceptual comparison in a situation where both signs share the **same** particular first name or surname (e.g. John / John Smith or Smith / John Smith) or contain mere **variants of the same** first name or surname (e.g. Ann / Anne Cooper, Mike / Michael Taylor or Schmidt / Hans Schmitt).

Signs	Territory	Comment	Case No
-------	-----------	---------	---------

CHIARA FERRAGNI (fig.) / Chiara	BX	The earlier mark will be recognised as a female first name while the contested mark as the combination of a female first name and a surname. It is not correct to consider the conceptual aspect to be 'neutral' for the assessment of the similarity of the signs (paras 67, 74).	08/02/2019, <a href="#">T-647/17</a> , EU:T:2019:73
------------------------------------	----	--	--

Just because a first name or a surname is not in use in a particular country does not prevent it from being perceived as a foreign first or surname provided that there are sufficient indications to support that finding. This is particularly the case with first names or surnames recognised after internationally known personalities or where a close equivalent exists in the country.

Signs	Territory	Comment	Case No
Ana de Altun (fig.) / Anna (fig.)	ES	The marks evoke the names 'Anna' and 'Ana', the same female first name in different ways of writing (para. 55).	18/09/2017, <a href="#">T-86/16</a> , EU:T:2017:627

Signs	Territory	Comment	Case No
CHIARA FERRAGNI (fig.) / Chiara	BX	'Chiara' will be perceived as a common Italian name by the relevant public as that name is known in the various local language versions, such as the French (Claire) or German version (Klara) (para. 70).	08/02/2019, <a href="#">T-647/17</a> , EU:T:2019:73



In addition, if the sign is perceived to be the name of a well-known personality or has a distinct (current) meaning, that specific concept is also relevant and must be taken into account.

Sign	Territory	Concept	Case No
PICASSO	EU	The word PICASSO has a clear and specific semantic content for the relevant public. The reputation of the painter Pablo Picasso is such that it is not plausible to consider, in the absence of specific evidence to the contrary, that the sign PICASSO as a mark for motor vehicles would, in the perception of the average consumer, override the name of the painter (para. 57).	22/06/2004, <a href="#">T-185/02</a> , EU:T:2004:189; dismissed 12/01/2006, <a href="#">C-361/04 P</a> , EU:C:2006:25
MESSI	EU	The fame of Lionel Andrés Messi Cuccittini is a relevant factor to be taken into account in the conceptual comparison (paras 47-48).	17/09/2020, <a href="#">C-449/18 P</a> & <a href="#">C-474/18 P</a> , MESSI (fig.) / MASSI et al., EU:C:2020:722



However, the fact that the signs at issue are perceived, for example, as mere ‘names’, ‘male / female first names’ or ‘Italian surnames’, does not confer any relevant concept on the signs for the purposes of the conceptual comparison. As such, just because ‘Thomas’ and ‘Michael’ are both ‘male first names’, this does not contribute any relevant concept for the purposes of comparison.

Signs	Territory	Concept	Case No
-------	-----------	---------	---------



ANTONIO RUBINI / RUTINI (fig.)	EU	The fact that the relevant public may notice that the marks have Italian surnames in common has no relevance for the purposes of conceptual comparison (para. 64).	11/07/2018, <a href="#">T-707/16</a> , EU:T:2018:424
-----------------------------------	----	--	---

### 3.4.3.5 The semantic content of figurative, shape and colour marks

The concepts of marks consisting of or containing figurative elements and marks consisting of shapes (three-dimensional marks) will be what those figurative elements or shapes represent, such as in the following examples.

Sign	Territory	Concept	Case No
	BX, DE, ES, FR, IT, AT, PT	The representation of a red mug on a bed of coffee beans.	25/03/2010, <a href="#">T-5/08</a> & <a href="#">T-7/08</a> , EU:T:2010:123
	DE	Part of the relevant public may recognise a peacock.	21/04/2010, <a href="#">T-361/08</a> , EU:T:2010:152
	BX	The contested trade mark will be described as a businessman playing football.	02/12/2009, <a href="#">R 403/2009-2</a>

Consequently, when a mark has both words and images, all concepts have to be assessed.

Sign	Territory	Concepts	Case No
	EN	<p>The word 'ugli' in the earlier mark is likely to be associated with the English word 'ugly' by the relevant public.</p> <p>A bulldog with a citrus fruit in front of it.</p>	15/04/2010, <a href="#">T-488/07</a> , EU:T:2010:145
	EU	<p>The term 'Rioja' in the earlier mark, which is itself conceptually strengthened by the representation of a bunch of grapes and a vine leaf, refers directly to grapevine products and, more particularly, to Rioja wine.</p>	09/06/2010, <a href="#">T-138/09</a> , EU:T:2010:226; dismissed 24/03/2011, <a href="#">C-388/10</a> <a href="#">P</a> , EU:C:2011:185
	BL, BX, CY, DE, ES, FR, HU, RO, SK, IT	<p>The mark depicts a type of fish (a shark).</p> <p>The majority of the relevant language speakers will understand the term SPAIN in the contested mark as referring to that country.</p> <p>The word 'Tiburón' means 'shark' in Spanish but will not be understood by the rest of the relevant public.</p> <p>The remaining term, SHARK, will probably be understood by English-speaking consumers in the relevant territories.</p>	29/09/2008, <a href="#">B 1 220 724</a>

Finally, the semantic content (concept) of colour marks per se is that of the colour they reproduce.

## 3.4.3.6 The semantic content of numbers and letters

The concept of a word representing a number is the figure it identifies, such as in the examples below.

Sign	Territory	Meaning	Case No
	DE	The word zero evokes the cardinal number 0.	16/09/2009, <a href="#">T-400/06</a> , zerorh+, EU:T:2009:331
TV2000 (fig.) / TV1000 et al.	LT	The signs are conceptually similar to the extent that they both share the idea of 'television' combined with a round four-digit number, that furthermore correlate in the order of thousands (para. 47).	19/10/2012, <a href="#">R 2407/2011-2</a>
7 (fig.) / 7 (fig.)	EU	The BoA found that '7' had a meaning (para. 25).	14/02/2012, <a href="#">R 782/2011-2</a>

The concept of a figure is the number it identifies, unless it suggests another concept such as a specific year.

Signs consisting of single letters are often expressed in a stylised or highly stylised form. Therefore, as a first step, it has to be assessed if at least a non-negligible part of the relevant public (20/07/2017, [T-521/15](#), D (fig.) / D (fig.) et al., EU:T:2017:536, § 69) will indeed recognise the signs as comprising a single letter (20/09/2019, [T-67/19](#), Dokkio / <IO (fig.), EU:T:2019:648, § 30).

The Grand Board of Appeal clarified that signs consisting of single letters have the ability to evoke and represent a particular idea, namely that of a specific letter. This is based on the same process of evocation as signs which represent any other ideas, such as the concept of a particular fruit, or of a tree. Therefore, in principle, signs perceived as a letter of the alphabet are only capable of conveying the '**generic concept**' of the specific letter (26/03/2021, [R 551/2018-G](#), Device (fig.) / Device (fig.), § 78, 85). The mere fact that there is a generic term which includes the terms used to describe the semantic content of the signs at issue is **not a relevant factor** in the context of the conceptual comparison (31/01/2019, [T-215/17](#), PEAR (fig.) / APPLE BITE (fig.) et al., EU:T:2019:45, § 69).

If the signs coincide **only in the 'generic concept' of the specific letter of the alphabet**, and there are no other (relevant) concepts to be taken into account, the mere fact that the same letter could serve to describe the signs under comparison is

not, in itself, sufficient to establish a conceptual identity or even similarity between those signs (26/03/2021, [R 551/2018-G](#), Device (fig.) / Device (fig.), § 79, 85). In such a case, the conceptual aspect will not influence the similarity of the signs. It logically follows that where the signs comprise different single letters, that alone will not have any impact on the similarity of the signs.



If, however, it can be established that the relevant public would perceive a particular letter, when represented within a sign, as evoking or representing some **specific meaning in relation to the goods and services** beyond the portrayal of that letter (e.g. the letters ‘S’, ‘M’ or ‘L’ indicating the size of *clothing*), such a concept must be taken into account in the conceptual comparison between the signs (26/03/2021, [R 551/2018-G](#), Device (fig.) / Device (fig.), § 80, 85).

The **graphic elements** of figurative signs may have an impact on the concepts each sign conveys. Depending on the concepts those graphic elements may evoke, that impact may be significant and even decisive for the conceptual comparison (26/03/2021, [R 551/2018-G](#), Device (fig.) / Device (fig.), § 82) and it may lead to conceptual similarity, identity or, indeed, conceptual dissimilarity. It follows that where the **graphical representation** of the single letter conveys a concept, this has to be taken into account in the conceptual comparison. However, a similar stylisation of the same letter does not affect the conceptual assessment unless the particular stylisation conveys a concept.

#### 3.4.3.7 The semantic content of geographical names

The names of cities, villages, regions and other geographic areas evoke a concept that may be relevant for conceptual comparison if it is likely that the relevant public will recognise them as such. Usually, the general public in the European Union is familiar with the names of capitals and bigger cities as well as holiday or travel destinations. If the perception of the public in a particular Member State is relevant, knowledge of the names of small cities and towns in that country can also be assumed.

A lack of evidence or indication that the relevant public recognises the geographical name does not influence the conceptual comparison, as in the following example.

Sign	Territory	Concept	Case No
v  	DE	The result of conceptual comparison is neutral. It is not possible to infer from the appellant's argument that the name 'Chtoura' designates an agricultural area in Lebanon renowned for its agricultural products that this meaning will also be familiar to trade circles in Germany.	08/05/2010, <a href="#">R 1213/2008-4</a>

#### 3.4.3.8 The semantic content of onomatopoeias and sounds

The analysis of the semantic content of onomatopoeias follows the general rules for conceptual comparison: their concept will be that depicted by the onomatopoeia in question, provided it can be established that it will be recognised as such by the relevant public. For instance, 'WOOF WOOF' represents the bark of a dog for English speakers; 'MUUU' represents the mooing of a cow for Spanish speakers.

Sign	Territory	Concept	Case No
CLICK	DE	Conceptually, the contested mark 'CLICK' is an English onomatopoeia that expresses a short, sharp sound. This word will be readily understood in Germany given its close equivalent in German, 'Klick' (para. 45).	28/01/2008, <a href="#">R 1394/2006-2</a>

In some cases, the context in which the onomatopoeia will be used can be decisive for establishing whether the relevant public will recognise its meaning. For instance, in the following case, the Board considered that the relevant public would not interpret the sign 'PSS' as onomatopoeia in the context of information technology services.

Sign	Territory	Concept	Case No
PSS	ES	The applicant's argument that the earlier mark could also be pronounced as an onomatopoeia [prompting another to be quiet] is far-fetched in view of the relevant information technology services at issue and the relevant public, who is accustomed, as noted by the applicant itself, to acronyms in this field (para. 42).	15/09/2008, <a href="#">R 1433/2007-2</a>

The sound element in a sound or multimedia mark may convey a concept. This is particularly the case for true-to-life sounds, such as the sound of a dog barking, thunder, ice cubes clinking.

Sign	Territory	Concept	Case No
 <a href="#">Link</a>	EU	The mark conveys the concept of a cow mooing.	Invented example <a href="#">(CP11)</a>

A sound mark that merely contains a melody is unlikely to have a concept.

#### 3.4.4 Conceptual comparison

In essence, when making a conceptual comparison, first it has to be determined if the signs have a concept in accordance with the principles described in the previous paragraph.

- If both signs have a concept, the conceptual comparison can lead to three possible outcomes.
  - If the signs, each as a whole, refer to the same concept, they are conceptually identical.
  - If the signs refer to similar concepts, they are conceptually **similar**.

- If both signs have a meaning and each refers to different concepts, they are conceptually **dissimilar/not similar**.
- If only one of the signs evokes a concept, the signs are **conceptually dissimilar/not similar**.

On this point, the Office follows the judgment of 12/01/2006, [C-361/04 P](#), Picaro, EU:C:2006:25. Although there is some case-law, such as the judgment of 22/10/2015, [T-309/13](#), ELMA / ELMEX, EU:T:2015:792, which came to the conclusion that 'it was not possible to make a conceptual comparison', even though only one of the signs evoked a concept, these cases cannot be considered as a prevailing trend.

- If neither sign has any concept, a conceptual **comparison is not possible** (13/05/2015, [T-169/14](#), Koragel / CHORAGON, EU:T:2015:280, § 68-69). The conceptual aspect does not influence the assessment of the similarity of the signs.

As also explained in [paragraph 3.4.5.2](#), the fact that **the signs have a descriptive or otherwise non-distinctive element in common** does not suffice to deny all conceptual similarity between them. This fact does not alter the conceptual content of the signs (16/12/2015, [T-491/13](#), TRIDENT PURE / PURE et al., EU:T:2015:979, § 93 and case-law cited; 15/10/2018, [T-164/17](#), WILD PINK / PINK LADY et al., EU:T:2018:678, § 88-89). Nevertheless, depending on the circumstances of the particular case, for example where the only non-distinctive element in common is accompanied by a meaningful distinctive element, the marks may, exceptionally, be found conceptually dissimilar.

The signs cannot be considered conceptually similar on the sole ground that a generic term covering both of them exists and/or they fall under the same general category of signs. If the semantic meanings are too different, the signs may share a general concept, but one so broad that the conceptual relationship is not relevant, as in the following cases.

- The mere fact that two words or symbols can be **grouped under a common generic term** by no means makes them conceptually similar. For example, the General Court held that, although an apple and a pear had features in common, both being fruits that are closely related in a biological sense and are of similar size, colour and texture, such common features had a very limited influence on the overall impression. The Court found that the relevant public would notice such common features only after a detailed analysis. Furthermore, apples and pears are not the only fruit that can be red, yellow or green, and the same applies to the comparable size and texture. Consequently, the Court found these elements insufficient to counterbalance the clear conceptual differences between the marks, which thus rendered them conceptually dissimilar (31/01/2019, [T-215/17](#), PEAR (fig.) / APPLE BITE (fig.) et al., EU:T:2019:45, § 77-79).
- The same happens when two signs belong to the **same general category or type of mark**: the fact that 'TDL' and 'LNF' are both three-letter abbreviations is conceptually irrelevant and therefore, a conceptual comparison is not possible.



- Another example of signs ‘belonging to the same category’ concerns **names** and surnames that have a similar semantic content (see [paragraph 3.4.3.4](#)). If FRANK and MIKE are compared, the fact that they are both names is conceptually irrelevant (since they are on completely different levels).

In particular, the marks will be conceptually identical or similar in the following situations.





#### 3.4.4.1 Both marks share a word and/or expression

When the two marks share the same word or expression, the marks will be conceptually similar, as in the following examples.

Earlier sign	Contested sign	Opposition No
		17/06/2009, <a href="#">B 1 209 618</a> (ES)
Similar: the marks share the concept of SOL (= sun: ‘the star that is the source of light and heat for the planets in the solar system’).		
Earlier sign	Contested sign	Case No
BLUE	ECOBBLUE	12/11/2008, <a href="#">T-281/07</a> , EU:T:2008:489; dismissed 22/01/2010, <a href="#">C-23/09 P</a> , EU:C:2010:35 (EU)
The marks at issue are conceptually similar because they both refer to the colour blue.		
Earlier sign	Contested sign	Opposition No
T-MUSIC		<a href="#">B 1 081 167</a> (EU)
The marks above are conceptually similar because both refer to the concept of MUSIC (= ‘the art of arranging sounds in time so as to produce a continuous, unified, and evocative composition, as through melody, harmony, rhythm, and timbre’).		
Earlier sign	Contested sign	Opposition No
		29/09/2008, <a href="#">B 1 220 724</a> (BL, BX, CY, CZ, DE, ES, FR, HU, RO, SK and IT)

Earlier sign	Contested sign	Opposition No
The marks above are conceptually similar because both signs have an image of the same fish (a shark) and a reference to the word SHARK (= 'any of numerous chiefly marine carnivorous fishes of the class <i>Chondrichthyes</i> (subclass <i>Elasmobranchii</i> ) ...').		
Earlier sign	Contested sign	Case No
EL CASTILLO	CASTILLO	04/11/2003, <a href="#">T-85/02</a> , EU:T:2003:288 (ES)
The Court found that the signs were almost identical conceptually.		
Earlier sign	Contested sign	Case No
Servus et al.	SERVO SUO	29/02/2012, <a href="#">T-525/10</a> , EU:T:2012:96 (EU, IT in particular)
The signs are conceptually similar from the point of view of the average Italian consumer insofar as both signs share a reference to 'servant'. The Court confirmed the BoA finding that the Italian public was likely to perceive the meaning of the Latin word 'SERVUS', given its proximity to the Italian word 'SERVO'.		

As already mentioned, misspellings may also have a semantic content and in such cases can be compared, as in the following examples.

Earlier sign	Contested sign	Case No
		14/09/2011, <a href="#">T-485/07</a> , EU:T:2011:467 (ES)
For the relevant Spanish public, both signs invoke the concept of an olive. There is no evidence that the relevant Spanish consumer will understand the English word 'live'.		
Earlier sign	Contested sign	Opposition No
		14/07/2009 <a href="#">B 1 142 688</a> (EU)
Both marks refer to the word yogurt and consequently share the concept of 'a dairy product produced by bacterial fermentation of milk'.		

Earlier sign	Contested sign	Case No
	<p><b>C@risma</b></p>	<p>28/10/2008,  <a href="#">B 1 012 857</a>            (ES)</p>
<p>The above marks are conceptually similar because they both refer to the concept of ‘charisma’ (= ‘the ability to develop or inspire in others an ideological commitment to a particular point of view’).</p>		

#### 3.4.4.2 Two words or terms have the same meaning but in different languages

It is possible for the relevant public to assign a conceptual similarity or even identity in cases of marks with elements in different languages, as long as the meanings of the words in those languages are known to that public.

In the following example, it was found that the marks were conceptually identical because a substantial part of the Portuguese public would understand the words constituting the marks at issue given (i) the close proximity of the English word ‘vitamin’ to the Portuguese equivalent term ‘vitamina’, (ii) ‘water’ is a basic English word likely to be understood by that part of the Portuguese public that has sufficient knowledge of the English language, (iii) that ‘aqua’ is a widespread Latin expression and resembles the Portuguese equivalent term ‘água’ (paras 56-60).

Earlier sign	Contested sign	Case No
<p>VITAMINWATER            (relevant territory Portugal)</p>		<p>28/11/2013,            EU:T:2013:615  <a href="#">T-410/12</a>,</p>

As it is the actual understanding of the relevant public that matters, the mere fact that one term is objectively the foreign-language equivalent of the other may not be relevant at all in the conceptual comparison.

Earlier sign	Contested sign	Case No
	LE LANCIER	26/09/2012, <a href="#">T-265/09</a> , EU:T:2012:472
The relevant territory is Spain. 'El lancero' (in Spanish) means 'le lancier' in French. Conceptually, the GC concluded that the average Spaniard only had a limited knowledge of French and that the expression 'le lancier' did not belong to the basic vocabulary of that language. Conceptually, the signs are not similar.		

#### 3.4.4.3 Two words refer to the same semantic term or variations thereof

There is conceptual identity where synonyms are involved, that is to say where two words exist for the same semantic meaning (invented examples where English is the reference language: baggage/luggage; bicycle/bike; male horse/stallion).





Conceptual similarity was found in the following cases.

Earlier sign	Contested sign	Case No
SECRET PLEASURES	PRIVATE PLEASURES	15/06/2000, <a href="#">R 616/1999-1</a>
	ORPHAN INTERNATIONAL	14/06/2010, <a href="#">R 1142/2009-2</a>

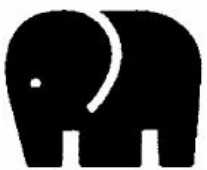
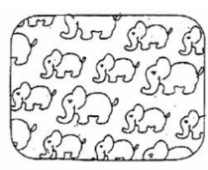
#### 3.4.4.4 Two purely figurative marks represent the same or a similar concept

When two purely figurative marks represent the same or a similar concept, the signs will be conceptually identical or similar.

Earlier sign	Contested sign	Case No
		07/02/2012, <a href="#">T-424/10</a> , EU:T:2012:58, § 52 (similarity)



Earlier sign	Contested sign	Case No
		12/04/2012, <a href="#">R 703/2011-2</a> (identity)
		17/06/2011, <a href="#">R 1107/2010-2</a> (identity)

3.4.4.5 When there is a word versus a figurative, shape or colour mark representing the concept behind the word

Conceptual identity also exists between a word and an image showing what the word represents (fictional examples: word mark 'TIGER' compared with a figurative mark depicting a tiger; or word mark 'orange' and a mark for the colour orange per se).

3.4.4.6 When both marks have figurative elements with the same or an analogous concept, one or both accompanied by verbal elements



If each of the signs has a non-negligible figurative element with an independently identifiable concept, and these concepts are the same (identical) or analogous (similar), the signs as a whole are conceptually similar. The degree of similarity depends on various factors, such as whether the concepts are identical or similar, whether the verbal elements reinforce the concept of the figurative elements or rather introduce different concepts, whether the verbal elements appear in both signs or in only one, and the distinctiveness of the common concept.



Earlier sign	Contested sign	Case No
		16/10/2018, <a href="#">T-548/17</a> , EU:T:2018:686
<p>G&amp;S: Classes 14, 18, 25</p> <p>Territory: EU</p> <p>Assessment: Notwithstanding the verbal elements that have no meaning, both marks represent a monkey that results in conceptual similarity for the signs taken as a whole (paras 46-49).</p>		



Earlier sign	Contested sign	Case No
		27/02/2002, <a href="#">R 68/2001-4</a> & <a href="#">R 285/2001-4</a>
<p>G&amp;S: Classes 18, 24, 25, 28</p> <p><i>Territory:</i> Benelux, Germany, Spain, France, Italy, Austria</p> <p><i>Assessment:</i> the wording 'La Maison de la Fausse Fourrure' is not sufficient to reduce the impression of similarity between the conflicting marks. In addition to its possibly descriptive nature, the wording, compared with the footprint device, occupies a secondary position (it is placed under the device), is of a relatively limited size (four times smaller) and is in a conventional writing style (para. 22).</p>		

### Signs with figurative elements corresponding to the meaning of the verbal elements

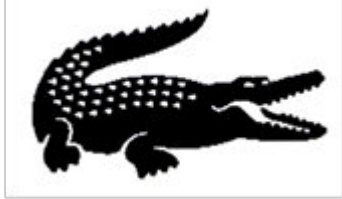

The concept inherent in the figurative element may be reinforced by the verbal part in defining a particular **concept** and may even help with the understanding of words that, in principle, might not be widely known to consumers. This strengthens the conceptual similarity.

Earlier sign	Contested sign	Case No
		17/04/2008, <a href="#">T-389/03</a> , EU:T:2008:114
<p>G&amp;S: Classes 1, 2, 17</p> <p><i>Territory:</i> EU</p> <p><i>Assessment:</i> As regards the earlier trade marks, it must be held that the word element 'Pelikan' will be understood by consumers as a direct reference to the figurative element. Each of those two elements, appearing side by side, reinforces the other, so that consumers more easily understand one because of the other. Taken together, the two elements clearly call to mind the idea of a pelican. The signs are conceptually identical (paras 90-91).</p>		

Earlier sign	Contested sign	Case No
		<p>30/09/2015, <a href="#">T-364/13</a>, EU:T:2015:738</p>
<p>G&amp;S: Classes 18, 25</p> <p><i>Territory:</i> EU</p> <p><i>Assessment:</i> The verbal element in the contested mark will be understood as a direct reference to the figurative element at least in Member States where the word 'kajman' or its close linguistic variation exists. Since the marks at issue are perceived as representing a reptile of the crocodilian order, they have analogous semantic content and are thus conceptually similar to at least an average degree (paras 47, 48, 53).</p>		

Earlier sign	Contested sign	Case No
		<p>20/10/2011, <a href="#">T-238/10</a>, EU:T:2011:613</p>
<p>G&amp;S: Class 18</p> <p><i>Territory:</i> Portugal</p> <p><i>Assessment:</i> Even assuming that some consumers might wonder for a moment whether the figurative element depicts a horse in the contested mark, any possible confusion is removed by the word element 'horse', which will be understood as such by the majority of the Portuguese public. The word and figurative elements reinforce each other, with the result that consumers will more easily understand one because of the other. As both marks will evoke the same concept of a horse, they are conceptually identical (paras 30, 39).</p>		

Earlier sign	Contested sign	Case No
--------------	----------------	---------

		<p>14/12/2006, <a href="#">T-81/03</a>, <a href="#">T-82/03</a> &amp; <a href="#">T-103/03</a>, EU:T:2006:397</p>
<p>G&amp;S: Classes 32, 33</p> <p>Territory: Spain</p> <p>Assessment: The Spanish public will perceive the term 'venado' (meaning 'deer') not independently, but as a direct reference to the figurative element in the contested marks. The marks are conceptually similar (para. 100).</p>		

3.4.4.7 When the signs have a meaningful word in common that is distinctive, and one of them contains an additional word or figurative element without any meaning

Where the signs have a meaningful word in common that is distinctive, and one or both of them contains an additional word element without any meaning (a fanciful word or one that will not be understood in the relevant language area), the signs are considered conceptually highly similar, and not identical. In such a case, even if not understood, the relevant public will note the presence of the additional term that prevents the signs from being perceived as conceptually totally identical.

Earlier sign	Contested sign	Case No
VIKING	VIKING PRUX	Invented example
VIKING DREMBL	VIKING PRUX	Invented example
<p>The relevant territory is the European Union. The goods at issue are <i>cosmetics</i> in Class 3. The word 'VIKING' is understood throughout the European Union and is distinctive for the goods at issue. The words 'PRUX' and 'DREMBL' have no meaning. The signs are conceptually highly similar.</p>		

However, where the word that the signs have in common is accompanied by additional figurative elements that lack any particular concept (such as a background, colours or a particular typeface), the signs are considered conceptually identical. In such a case, the additional figurative elements have no impact on the conceptual perception of the signs.



Earlier sign	Contested sign	Case No
		Invented example
<p>The relevant territory is the European Union. The goods at issue are <i>cosmetics</i> in Class 3. The word 'VIKING' is understood throughout the European Union and is distinctive for the goods at issue. The additional figurative elements do not introduce any concept capable of altering the conceptual perception of the signs. The signs are conceptually identical.</p>		

#### 3.4.4.8 When the signs share a personal name



In as much as signs have elements in common that are perceived as personal names (see [paragraph 3.4.3.4](#)), it is possible to compare them conceptually.

The basic premise to be followed is that less weight is generally given to the overlap in a first name than to an overlap in a surname. However, it should be highlighted from the outset that whether or not there is a likelihood of confusion is an issue that needs to be tackled in the global assessment. Indeed, this is where the intrinsic qualities of names and their particularities, such as how rare or common they are, need to be evaluated (see the Guidelines, [Part C, Opposition, Section 2, Double Identity and Likelihood of Confusion, Chapter 7, Global Assessment, paragraph 7.2.1](#))

Below are some of the most common scenarios for the conceptual comparison of signs containing personal names.

##### (i) First name versus first name and surname – overlap in the first name

If the signs share the same first name but differ in a surname, present only in one of them, they are **conceptually not similar**. This is due to the fact that the combination of a first name and surname identifies a particular person which is not the case where only a first name is given as it just refers to somebody by this name, but nobody specific.

Earlier sign	Contested sign	Case No
		18/09/2017, <a href="#">T-86/16</a> , ANA DE ALTUN (fig.) / ANNA (fig.) et al., EU:T:2017:627

G&S: Class 33

*Territory:* Spain

*Assessment:* Although both marks refer to a woman's name, the contested mark identifies a specific woman by the surname 'De Altun' or as a place whilst the earlier mark just brings to mind a first name but does not identify a specific person. The signs are conceptually dissimilar (para. 55).

### (ii) First name and surname versus first name and surname – overlap in the first name

If the signs share the same first name but differ in the surnames in each of them, they are **conceptually not similar**. While the signs may coincide in a first name, the different surname indicates that the names belong to different specific persons.

Earlier sign	Contested sign	Case No
ANNA DE CODORNÍU	ANNA FENNINGER	20/07/2016, <a href="#">R 115/2016-2</a> , ANNA FENNINGER / ANNA DE CODORNÍU et al.
<p>G&amp;S: Classes 32 and 34</p> <p><i>Territory:</i> the EU and Spain</p> <p><i>Assessment:</i> The contested mark refers to a specific person named 'Anna' who is a member of the 'FENNINGER' family. Both the Spanish public and non-Spanish speaking part of the public would perceive the earlier mark as a first name 'Anna' followed by a composite surname. To the extent they contain different surnames, the signs present conceptual differences given that they refer to two different specific individuals with an outcome of conceptual dissimilarity (paras 55, 58 and 59).</p>		

### (iii) Overlap in the surname

However, in the scenarios where the signs share the same surname but one of the signs contains an additional first name or both contain different first names, the fact that the signs overlap in a surname is relevant to find **conceptual similarity** as this is indicative of being part of the same family.

Earlier sign	Contested sign	Case No
BASILE		<p>28/06/2012, <a href="#">T-133/09</a>, B. Antonio Basile 1952, EU:T:2012:327</p> <p>appeal dismissed, 06/06/2013, <a href="#">C-381/12 P</a>, B. Antonio Basile 1952, EU:C:2013:371</p>

G&S: Class 25

*Territory:* Italy

*Assessment:* The signs are conceptually similar in that they share the same surname (para. 60).

Earlier sign	Contested sign	Case No
MARSHALL		08/11/2017, <a href="#">T-271/16</a> , Thomas Marshall Garments of Legends (fig.) / MARSHALL et al., EU:T:2017:787

G&S: Class 9

*Territory:* EU

*Assessment:* Signs composed of an identical element perceived as a surname will be understood by the relevant public as designating the names of people having the same surname. Since the word 'marshall' may be perceived by the relevant public as a surname, the addition of the word 'thomas', which would be the first name of a member of that family, does not render the signs at issue conceptually different (para. 78).

#### (iv) First name versus first name

The signs are **conceptually identical** if they are understood as variants of the same first name in use in the same country and **conceptually similar** where one is understood as a foreign equivalent of the other first name.

Earlier sign	Contested sign	Case No
ELISE		24/03/2010, <a href="#">T-130/09</a> , Eliza, EU:T:2010:120

G&S: Classes 9, 37 and 42

*Territory:* EU

*Assessment:* In Member States where the signs are considered as diminutives of the female first name Elizabeth (such as Ireland, Germany or Austria), the signs are conceptually identical. Elsewhere, where they are considered as highly similar female first names derived from the same root, the signs are conceptually highly similar (paras 36 and 40).

Earlier sign	Contested sign	Case No
José	Pepe	Invented example
<p>G&amp;S: Class 25</p> <p><i>Territory:</i> Spain</p> <p><i>Assessment:</i> The relevant Spanish public will understand the contested sign 'Pepe' as a diminutive of the Spanish first name 'José'. The signs are conceptually identical.</p>		

Earlier sign	Contested sign	Case No
Miguel	Michael	Invented example
<p>G&amp;S: Class 25</p> <p><i>Territory:</i> Spain</p> <p><i>Assessment:</i> The relevant Spanish public will understand the contested sign 'Michael' as a foreign equivalent of the Spanish first name 'Miguel'. The signs are conceptually similar.</p>		

#### (v) Surname versus surname

The signs are **conceptually identical** if they are understood as variants of the same surname in use in the same country and **conceptually similar** where one is understood as a foreign equivalent of the other surname.

Earlier sign	Contested sign	Case No
Schmidt	Schmid	Invented example
<p>G&amp;S: Class 25</p> <p><i>Territory:</i> DE</p> <p><i>Assessment:</i> The relevant German public will understand the signs as variants of the same surname in use in the same country. The signs are conceptually identical.</p>		

Earlier sign	Cotested sign	Case No
Schmidt	Smith	Invented example

G&S: Class 25

Territory: DE

*Assessment:* The relevant German public will understand the contested sign 'Smith' as a foreign equivalent of the German surname 'Schmidt'. The signs are conceptually similar.

(vi) Surname vs name of a well-known personality – overlap in the surname

If one of the signs contains the name of a well-known personality, the relevant public may associate a coinciding surname with that famous person or, at least, perceive it to be referring to the family of that famous person leading to **conceptual similarity**.

Earlier sign	Cotested sign	Case No
MARSHALL		08/11/2017, <a href="#">T-271/16</a> , Thomas Marshall Garments of legends (fig.) / MARSHALL et al., EU:T:2017:787
<p>G&amp;S: Class 9</p> <p>Territory: EU</p> <p><i>Assessment:</i> Even if the contested sign was perceived as the name of a well-known person (a politician, once Vice-President of the United States), it cannot be precluded that the relevant part of the public would perceive the earlier mark consisting of the surname 'Marshall' as itself referring to the same well-known person, or at the very least to his family, thus, leading to a conceptual similarity (para. 79).</p>		

(vii) Surname versus similar surname of a well-known personality – no overlap

Where one of the signs is recognised as the surname of a well-known personality, in the absence of an overlap in that surname, the signs are **conceptually dissimilar**.

Earlier sign	Contested sign	Case No
PICASSO	PICARO	22/06/2004, <a href="#">T-185/02</a> , Picaro, EU:T:2004:189; appeal dismissed 12/01/2006, <a href="#">C-361/04 P</a> , Picaro, EU:C:2006:25

G&S: Class 12

*Territory:* EU

*Assessment:* From the conceptual point of view, the earlier mark 'PICASSO' is particularly well known to the relevant public as being the name of the famous painter Pablo Picasso. The contested sign 'PICARO' may be understood by Spanish-speaking persons as referring inter alia to a character in Spanish literature, whereas it has no semantic content for the (majority) non-Spanish-speaking section of the relevant public. The signs are not thus similar from the conceptual point of view. The word 'PICASSO' has a clear and specific semantic content for the relevant public. The reputation of the painter Pablo Picasso is such that it is not plausible to consider, in the absence of specific evidence to the contrary, that the sign 'PICASSO' as a mark for motor vehicles would, in the perception of the average consumer, override the name of the painter (paras 55, 57).

Earlier sign	Contested sign	Case No
MASSI	MESSI	26/04/2018, <a href="#">T-554/14</a> , MESSI (fig.) / MASSI et al., EU:T:2018:230; appeal dismissed, 17/09/2020, <a href="#">C-449/18 P</a> & <a href="#">C-474/18 P</a> , MESSI (fig.) / MASSI et al., EU:C:2020:722

G&S: Classes 9, 25 and 28

*Territory:* EU

*Assessment:* The fame of Lionel Andrés Messi Cuccittini introduces a relevant conceptual difference between the signs. The signs will be perceived by the public to be conceptually dissimilar (paras 61-63).



#### 3.4.4.9 Sound marks

The principles below have been agreed in the Common Communication on New Types of Marks: Examination of Formal Requirements and Grounds for Refusal ([CP11](#)).



A conceptual comparison between two sound marks and between sound marks and other types of mark can be made if a concept can be identified.

If a mark contains a true-to-life sound, its meaning will have to be taken into account when determining the concept of the sound mark.

Earlier sign (sound mark)	Contested sign (sound mark)	Case No
---------------------------	-----------------------------	---------



		Invented example ( <a href="#">CP11</a> )
<a href="#">Link</a>	<a href="#">Link</a>	
<p>G&amp;S: Class 25</p> <p>Territory: EU</p> <p>Assessment: Both marks consist exclusively of the reproduction of a cow mooing. Although the sound is different, the concept is identical.</p>		

Bearing in mind the abovementioned principle that a sound mark can be conceptually compared with another type of mark when a concept can be identified, in the example below the signs coincide in the concept of ‘bananas’.

Earlier sign (sound mark)	Contested sign (figurative mark)	Case No
		Invented example ( <a href="#">CP11</a> )
<a href="#">Link</a>		
<p>G&amp;S: Class 25</p> <p>Territory: EU</p> <p>Assessment: The earlier mark consists of the pronunciation of the verbal element ‘bananas’, whereas the contested mark consists of an image of bananas. Therefore, the marks are conceptually identical.</p>		

If a sound mark contains verbal elements, their meaning will have to be taken into account when determining the concept of the mark. In the example below, the conceptual comparison will be made between the (distinctive) concepts of ‘banana’ and ‘potato’.

Earlier sign (sound mark)	Contested sign (sound mark)	Case No
---------------------------	-----------------------------	---------

		Invented example ( <a href="#">CP11</a> )
<a href="#">Link</a>	<a href="#">Link</a>	
<p>G&amp;S: Class 25</p> <p><i>Territory:</i> EU</p> <p><i>Assessment:</i> The verbal elements in the marks have different meanings, namely 'banana' and 'potato'. Therefore, the marks are conceptually dissimilar.</p>		

### 3.4.4.10 Motion marks

The principles below have been agreed in the Common Communication on New Types of Marks: Examination of Formal Requirements and Grounds for Refusal ([CP11](#)).

If a motion mark contains verbal and/or figurative elements that have a concept, the conceptual comparison must be done by considering those concepts in the usual way.

The movement or transformation of the elements of a motion mark, in itself, is unlikely to have a concept. It follows that if the elements making up the motion mark lack any concept, the movement or transformation of the elements itself is unlikely to convey any concept for that mark.



Earlier sign (word mark)	Contested sign (motion mark)	Case No
BANANA		Invented example ( <a href="#">CP11</a> )
	<a href="#">Link</a>	
<p>G&amp;S: Class 25</p> <p><i>Territory:</i> EU</p> <p><i>Assessment:</i> The earlier mark consists of the verbal element 'banana'. The contested motion mark consists of the verbal element 'banana' in motion. The concept of both marks is 'banana'. Therefore, the marks are conceptually identical.</p>		

However, the movement could reinforce, add to or, in some cases, alter the concept of the element in motion.

Earlier sign (figurative mark)	Contested sign (motion mark)	Case No

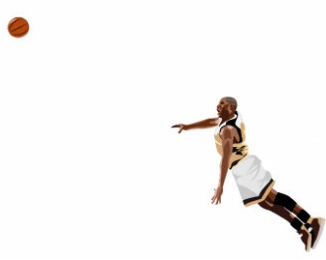

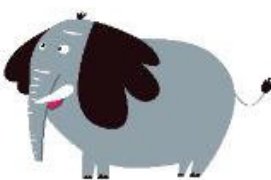

	 <p><a href="#">Link</a></p>	<p>Invented example (<a href="#">CP11</a>)</p>
<p>G&amp;S: Class 13</p> <p><i>Territory:</i> EU</p> <p><i>Assessment:</i> The figurative mark consists of a still image of a basketball player throwing a ball, whereas the motion mark consists of the same basketball player throwing the ball in motion. The combination of the element with the motion reinforces the initial concept of 'basketball player throwing a ball'. Therefore, the marks are conceptually identical.</p>		

Earlier sign (figurative sign)	Contested sign (motion mark)	Case No
	 <p><a href="#">Link</a></p>	<p>Invented example (<a href="#">CP11</a>)</p>
<p>G&amp;S: Class 25</p> <p><i>Territory:</i> EU</p> <p><i>Assessment:</i> The concept of the figurative mark is 'elephant' or 'cartoon of an elephant'. The combination of this cartoon with the dancing motion, adds a concept to the initial one, 'cartoon of a dancing elephant'. Therefore, the marks are conceptually similar.</p>		

#### 3.4.4.11 Multimedia marks

The principles below have been agreed in the Common Communication on New Types of Marks: Examination of Formal Requirements and Grounds for Refusal ([CP11](#)).

Multimedia marks can be compared conceptually as long as a concept is conveyed. When assessing the mark conceptually, attention should be paid to the interaction of the sound and visual elements as this might influence the global impression and/or meaning of the mark. When comparing a multimedia mark, in specific circumstances, the impact of an aural element could change how a sign is perceived conceptually.

Earlier sign (figurative mark)	Contested sign (multimedia mark)	Case No
	 <p><a href="#">Link</a></p>	<p>21/09/2020, <a href="#">B 3 071 595</a></p>
<p>G&amp;S: Classes 9, 28, 41</p> <p>Territory: UK</p> <p>Assessment: The signs will be associated with the same concept conveyed by the distinctive elements 'THUNDER BALL', namely 'an electric phenomenon called a fire-ball or globe lighting'. The signs are conceptually similar to a high degree.</p>		

### 3.4.4.12 Single letters



As stated in [paragraph 3.4.3.6](#), in the case of single letters, it is only where the letter itself has a meaning in relation to the goods and services at issue or where its graphical representation conveys a specific concept that such concepts are relevant for the purposes of the conceptual comparison.

Earlier sign	Contested sign	Case No
		<p>14/03/2017, <a href="#">T-276/15</a>, EU:T:2017:163</p>

G&S: Classes 4, 11, 37, 39, 40 and 42

*Territory:* EU

*Assessment:* The letter 'e', associated with the relevant goods and services, informs the relevant public that those goods and services are connected with energy or electricity, given that the letter 'e' is often used to abbreviate the terms 'energy' or 'electricity'. Consequently, the signs are conceptually identical for the relevant public who will perceive the marks at issue as referring to 'energy' or 'electricity' (para. 27).

Earlier sign	Contested sign	Case No
		<p>26/03/2021, <a href="#">R 551/2018-G</a></p>

G&S: Class 36

*Territory:* France

*Assessment:* Even if both signs could be described using generic terms such as an 'A' or as 'a stylised letter 'A', the concept evoked by the figurative signs in question would in no way be limited merely to those generic terms relating to the letter 'A'. On the contrary, due to its figurative elements, the earlier sign would be perceived conceptually at most as 'a capital letter A in the form of an open tent'. The sign applied for would be seen at most as representing 'the capital letter A in the form of a house of cards'. Therefore, the signs are not conceptually similar even though they refer to the same letter (para. 83).

### 3.4.5 Impact of the distinctive and dominant character of the components on the similarity of signs

When assessing similarity between signs, account must be taken of (i) whether the element they have in common is recognisable or rather remains unnoticed in the overall impression of both marks ([paragraph 3.4.5.1](#) below), (ii) the distinctiveness and dominant character of the common elements ([paragraph 3.4.5.2](#) below), and the (iii) impact of the remaining elements in the overall impression conveyed by each of the marks ([paragraph 3.4.5.3](#) below).

#### 3.4.5.1 Identifiable common element



Two marks are similar when, from the point of view of the relevant public, they are at least partly identical as regards one or more relevant aspects (23/10/2002, [T-6/01](#),

Matratzen + Matratzenmarkt Concord (fig.), EU:T:2002:261, § 30). Although the average consumer normally perceives a mark as a whole and does not proceed to analyse its various details, the fact remains that, when perceiving a word sign, they will break it down into elements that, for them, suggest a specific meaning or that resemble words known to them (13/02/2007, [T-256/04](#), Respicur, EU:T:2007:46, § 57). The element in common can be clearly identified when it appears **independently** in each sign.

Earlier sign	Contested sign	Reason	Case No
BEYOND VINTAGE	BEYOND RETRO	Coinciding first word.	30/04/2014, <a href="#">T-170/12</a> , EU:T:2014:238
SCHUHPARK	JELLO SCHUHPARK	The earlier trade mark is identical to the second word of the EUTM application.	08/03/2005, <a href="#">T-32/03</a> , EU:T:2005:82

The element in common may also be identified as a **part of** a single word where a **visual** separation allows it to be perceived independently (e.g. through the use of lower- and upper-case letters, the stylisation of letters or the use of a special character, such as a symbol, numeral, hyphen or other punctuation mark).

Earlier sign	Contested sign	Reason	Case No
ip_law@mbp	MBP	The earlier mark is composed of the elements 'ip-law' and 'mbp' separated by the '@' symbol, so that the marks have the element 'mbp' in common (para. 53).	16/09/2013, <a href="#">T-338/09</a> , EU:T:2013:447

Earlier sign	Contested sign	Reason	Case No
MAXX		The use of upper-case and lower-case letters and different colour shades immediately allows separate identification of the elements 'Nara' and 'Maxx', notwithstanding that neither of them has any meaning for the relevant Bulgarian public.	22/09/2017, <a href="#">T-586/15</a> , EU:T:2017:643, § 37, 46
		The letters 'FŁT' have an independent role in the EUTM application due to the colour red (para. 48).	14/05/2013, <a href="#">T-19/12</a> , EU:T:2013:242
TRONIC		The common element 'TRONIC' is separated visually in the contested mark by its white lettering (para. 38).	12/05/2016, <a href="#">T-775/14</a> , EU:T:2016:293

Furthermore, the element in common may also be identified as a **part of** a single word where a clear **conceptual meaning** allows it to be perceived independently (see also [paragraph 3.4.3.2](#) above).

Earlier sign	Contested sign	Reason	Case No
MARINE BLEU	BLUMARINE	The part 'marine' in the EUTM application will be understood as a reference to the sea and 'blu' as a misspelling of 'blue'.	14/05/2014, <a href="#">T-160/12</a> , EU:T:2014:252

Earlier sign	Contested sign	Reason	Case No
CADENACOR	COR	The Spanish-speaking public will be able to identify the element 'cor' separately within the earlier mark because the initial element 'cadena' suggests a concrete meaning (chain) to it (para. 47) — likelihood of confusion.	20/10/2011, <a href="#">T-214/09</a> , EU:T:2011:612
BLUE	ECOBUE	The relevant public will split the EUTM application into the commonly used prefix 'eco' and the word 'blue' (para. 30) — likelihood of confusion.	12/11/2008, <a href="#">T-281/07</a> , EU:T:2008:489; confirmed 22/01/2010, <a href="#">C-23/09</a> <a href="#">P</a> , EU:C:2010:35

On the contrary, if it remains unnoticed, the mere coincidence in a string of letters is not enough for a finding of similarity. The rule remains that the public compares the marks as a whole and will not artificially dissect them. In the following cases **the similarity of the marks was denied** despite an overlap in some letters (see also [paragraph 4](#) below, especially [paragraph 4.2.4](#)).

Earlier sign	Contested sign	Reason	Case No
CS	CScreen	The contested sign will probably be broken down into the elements 'C' and 'Screen', which has a meaning highly relevant for computers and their peripherals. It will not be perceived as containing the separate entity 'CS' corresponding to the earlier mark.	18/08/2010, <a href="#">R 545/2009-4</a>

## 3.4.5.2 Distinctiveness and dominant character of the common elements

For the conclusion of similarity, the **degree of distinctiveness of the common element** (or elements) must be taken into account. The more distinctive the common element is, the higher the degree of similarity. A finding that the common element has limited distinctiveness will lower the degree of similarity, with the consequence that if the only common element of both marks is non-distinctive, the degree of similarity will be low or the marks will even be dissimilar depending on the impact of the elements that differentiate the marks (see [paragraph 4.2.5](#) ).



In the following examples, the common element was considered descriptive or otherwise non-distinctive, with the consequence that the degree of similarity was considered low.

Earlier sign	Contested sign	Case No
FSA K-FORCE	FORCE-X	04/03/2015, <a href="#">T-558/13</a> , EU:T:2015:135
The element 'force' has a weak distinctive character for the goods concerned (Class 9: <i>Cycle helmets</i> ; Class 12: <i>Bicycle and bicycle parts and accessories thereof</i> ). Low degree of visual, phonetic and conceptual similarity – no likelihood of confusion.		

Earlier sign	Contested sign	Case No
PINK LADY	WILD PINK	15/10/2018, <a href="#">T-164/17</a> , EU:T:2018:678
The element 'pink' in both signs will be understood by the relevant public in the EU as denoting the colour pink. The element has a low degree of distinctive character as it indicates the colour of the relevant goods (fruits). The signs are considered to share at least a low degree of visual and aural similarity. They are deemed to have a low degree of conceptual similarity owing to the shared concept of the colour pink. Therefore, the General Court found that the Board was incorrect to take the view that the signs at issue are visually, phonetically and conceptually dissimilar (§ 79, 81, 88-89).		

Earlier sign	Contested sign	Case No
VISCOPLEX	VISCOTECH	19/11/2014, <a href="#">T-138/13</a> , EU:T:2014:973

Earlier sign	Contested sign	Case No
As regards the common initial part of the marks 'visco', it is descriptive for the German public with relation to one of the main characteristics of the relevant goods (oils, greases and fuels), namely its viscosity (para. 57). The marks are only vaguely similar visually and phonetically – no likelihood of confusion.		

Earlier sign	Contested sign	Case No
		22/05/2012, EU:T:2012:252 <a href="#">T-60/11</a> ,
The word premium is laudatory (para. 44). The coincidence leads only to a low visual and phonetic and an average conceptual similarity – no likelihood of confusion.		

The fact that the coinciding element is a non-distinctive element, does not however, suffice to deny any similarity between the marks, unless there are further factors differentiating them (see [paragraph 4.2.5](#) below). If the public will notice the overlap, it must be taken into account in the comparison. The fact that an element is descriptive or otherwise non-distinctive is not on its own sufficient to conclude that that word is negligible in the overall impression produced by that mark (08/02/2011, [T-194/09](#), Líneas aéreas del Mediterráneo, EU:T:2011:34, § 30).

(For the impact of common weak or non-distinctive components on likelihood of confusion see the Guidelines, [Part C, Opposition, Section 2, Double identity and likelihood of confusion, Chapter 7, Global assessment](#)).

The conclusion on similarity also has to take into account **whether the common element is dominant** (visually outstanding) or **at least codominant** in the overall impression of the marks. As explained previously (see [paragraph 3.3](#) above), within the assessment of the dominant character of one or more components, the intrinsic qualities (size, striking graphical representation, etc.) of each of those components have to be compared with the intrinsic qualities of the other components. In addition and accessorially, account may be taken of the relative position of the various components within the arrangement of the composite mark (08/06/2017, [T-341/13](#) RENV, So'bio etic (fig.) / SO...? et al., EU:T:2017:381, § 40 and 44-56; confirmed by 28/02/2019, [C-505/17 P](#), SO'BiO etic (fig.) / SO...? et al., EU:C:2019:157, § 39-53).

The distinctiveness and dominant character of the common element(s) are separate but related terms. According to the Court:

It should also be noted that where some elements of a trade mark are descriptive or non-distinctive, they are not generally regarded by the public as being dominant in the



overall impression conveyed by that mark, unless, particularly because of their position or their size, they appear likely to make an impression on consumers and to be remembered by them.



(31/01/2013, [T-54/12](#), Sport, EU:T:2013:50, § 24 and the case-law cited therein).

### 3.4.5.3 Importance of additional (not common) elements



Within the comparison of trade marks as a whole, the impact of the non-common elements in their overall impression also has to be taken into account in order to reach a conclusion on similarity. The more differences the remaining elements of the marks present, the lower would be the similarity resulting from the common element.

It cannot be generally assumed that the elements of difference between the marks would tend to become less marked in the consumer's memory in favour of the elements of similarity. In accordance with settled case-law, the extent of the similarity or difference between the signs at issue may depend, in particular, on the inherent qualities of the signs (13/05/2015, [T-169/14](#), Koragel / CHORAGON, EU:T:2015:280, § 84).

The distinctiveness and dominant character of the differentiating elements has to be, therefore, taken into account. If these elements are the distinctive ones and dominate the overall impression of the marks, the degree of similarity will decrease.

Earlier sign	Contested sign	Case No
		<p>18/06/2013, EU:T:2013:327</p> <p><a href="#">T-338/12</a>,</p>
<p>As regards the visual comparison, the figurative element representing a dog in the earlier mark constitutes the dominant one. Given that the respective graphic elements are different, the coincidence in the word element 'K9' leads to a visual similarity only to a low degree. The marks are phonetically similar to a high degree. As to the conceptual comparison, the contested mark does not contain any figurative element conveying the concept of a dog, the marks are not conceptually similar (paras 27-34).</p>		

On the contrary, if the element in which the marks differ is of less inherent distinctiveness than the common element, this will increase the degree of similarity.

Earlier sign	Contested sign	Case No
	 (NEGRA MODELO)	06/03/2002, <a href="#">R 536/2001-3</a> ; confirmed 15/02/2005, <a href="#">T-169/02</a> , EU:T:2005:46
<p>The earlier trade mark was a Portuguese registration. 'Negra' is descriptive for the relevant goods in Class 33, since it may be used in Portuguese to designate brown beer, i.e. the type of beer sold under the trade mark NEGRA MODELO. The attention of the average Portuguese consumer will be focused on the coinciding word 'modelo'. Low visual, average phonetic and strong conceptual similarity — likelihood of confusion.</p>		

### 3.4.6 Other principles to be taken into account in the comparison of signs

#### 3.4.6.1 The impact of the verbal element in the case of composite marks

When signs consist of both verbal and figurative components, in principle, the verbal component of the sign usually has a stronger impact on the consumer than the figurative component. This is because the public does not tend to analyse signs and will more easily refer to the signs in question by their verbal element than by describing their figurative elements (14/07/2005, [T-312/03](#), Selenium-Ace, EU:T:2005:289, § 37; 19/12/2011, [R 233/2011-4](#), BEST TONE (fig.) / BETSTONE, § 24; 13/12/2011, [R 53/2011-5](#), JUMBO (fig.) / DEVICE OF AN ELEPHANT (fig.), § 59).

However, the verbal element of a sign does not automatically have a stronger impact (31/01/2013, [T-54/12](#), Sport, EU:T:2013:50, § 40) and in certain cases, the figurative element of a composite mark may, owing to, inter alia, its shape, size, colour or position within the sign, rank equally with the word element (23/11/2010, [T-35/08](#), Artesa Napa Valley, EU:T:2010:476, § 37). Below are some examples of such a scenario:

Earlier sign	Contested sign	Case No
GIOVANNI	 <b>GIOVANNI GALLI</b>	03/06/2015, <a href="#">T-559/13</a> , EU:T:2015:353

Earlier sign	Contested sign	Case No
<p>G&amp;S: Class 3</p> <p>Territory: EU</p> <p>Assessment: The figurative element of the mark applied for <b>is as important as the word elements and has a significant impact on the overall visual impression</b> given by that mark. It is positioned above the word elements and occupies more space than both of those elements combined. Furthermore, it is distinctive for the goods at hand, as a duck has no connection with cosmetic or cleaning preparations. In addition, the drawing of the duck is quite elaborate. Even if the element 'GIOVANNI' is placed before the element 'GALLI', there is only <b>a low degree of visual similarity</b> between the marks at issue, in view of the significant impact of the figurative element of the mark applied for on the overall impression given by that mark (paras 62-64, 72, 74).</p>		
		<p>12/11/2015, EU:T:2015:839</p> <p><a href="#">T-449/13</a>,</p>

Earlier sign	Contested sign	Case No
<p>G&amp;S: Classes 32 and 33</p> <p><i>Territory:</i> Poland</p> <p><i>Assessment:</i> the figurative element of the mark applied for, consisting of the stylised representation of a bovine animal viewed in profile looking to the left and which may be perceived as a European bison, is of a similar size to that of the verbal element 'wisent' and occupies a comparable space in that mark. As a result of its shape, its size, its colour and its position, that representation of a bison [...] helps clearly to establish the image of the contested mark which the relevant public will retain in their mind, with the result that <b>it cannot be discounted in the perception of that mark</b> [...].</p> <p>As regards the earlier mark, a naturalistic representation of a bison standing on four legs in a circle against a background of trees, coloured green, brown and black, is clearly perceptible in that mark. That representation of a bison occupies a central position and is of a slightly larger size than the only perceptible verbal element, the term 'żubrówka', represented in yellow and black and placed above that representation. Therefore, <b>the figurative element</b> consisting of a naturalistic representation of a bison <b>cannot be discounted in the overall impression created by the earlier mark</b> [...]. Despite the presence of different verbal elements, as a whole the marks are <b>visually similar to a low degree</b> given the fact that they both contain a bison, the image of which will easily be retained by consumers in their memory as a result of their position within the marks at issue and their size (paras 76-77, 82, 85-86, 111, 113).</p>		

#### 3.4.6.2 Beginning of the signs in the visual and phonetic comparison

In word signs or in signs containing a verbal element, the first part is generally the one that primarily catches the consumer's attention and, therefore, will be remembered more clearly than the rest of the sign. This means that in general the beginning of a sign has a significant influence on the general impression made by the mark (15/12/2009, [T-412/08](#), Trubion, EU:T:2009:507, § 40; 25/03/2009, [T-109/07](#), Spa Therapy, EU:T:2009:81, § 30).

Nevertheless, the concept 'beginning of the sign' is undetermined, as there is no particular indication of what forms the beginning, what is the end or even if there is or is not a middle part of the sign. Again, this perception mostly depends on the circumstances of the case (length of sign, syllabic distribution, use of typeface, etc.) and not on a set rule. It could even be that a sign is perceived as having a short beginning and ending and a proportionally much larger middle or central part. Consequently, depending on the circumstances, the rule of the relevance of the beginning of the sign could have less weight to the benefit of a more relevant central part.

As it is usually the beginning of a sign that catches consumers' attention, where signs only differ in their endings, this difference is often insufficient to exclude similarity. However, this is not a fixed rule and the outcome depends on the circumstances of the case. Moreover, this rule only applies when the sign contains a verbal element (which

would explain reading from left to right) and when this verbal element is not very short (otherwise the sign will be perceived immediately in its entirety). The Office considers signs consisting of three or fewer letters/numbers as very short signs (see in more detail [paragraph 3.4.6.3](#) below).

In principle, coincidences at the beginning of signs increase their similarity more than in the middle or at the end.

Earlier sign	Contested sign	Case No
ALENTIS	ALENSYS	10/02/2011, <a href="#">R 1243/2010-1</a>
<p>G&amp;S: Class 42</p> <p><i>Territory:</i> Spain</p> <p><i>Assessment:</i> while both marks do not have any meaning and, thus, no conceptual comparison can be made, the trade marks are visually and phonetically highly similar, in particular because they coincide in their first four letters 'ALEN'. It is generally accepted that people pay more attention to the first part of a trade mark, at least when they perceive the mark visually (para. 33).</p>		
Earlier sign	Contested sign	Case No
AZURIL	AZULIB	01/06/2011, <a href="#">R 1543/2010-1</a>
<p>G&amp;S: Class 5</p> <p><i>Territory:</i> Greece</p> <p><i>Assessment:</i> the signs share five of their six letters and the first two syllables are identical. There is a certain degree of visual similarity. Aurally the signs are highly similar as the initial part, which is normally the most important, is identical. Neither sign has a meaning in Greek (paras 35-36).</p>		

However, the degree of similarity will usually be lower, despite identical beginnings, if those are the weak elements in the signs or if the remaining elements have a clearly different meaning.

Earlier sign	Contested sign	Case No
CALSURA	CALSORIN	15/12/2010, <a href="#">R 484/2010-2</a>

<p>G&amp;S: Class 5</p> <p><i>Territory:</i> EU</p> <p><i>Assessment:</i> visually, the marks share some similarity due to the coinciding letters 'C', 'A', 'L', 'S' and 'R' placed in the same order. Aurally, there is a low degree of similarity. Conceptually, the marks are similar insofar as they both contain the component 'CAL'. However, since this element clearly alludes to the kind of goods (containing 'calcium'), not much weight can be given to this conceptual similarity (paras 21-23) — no likelihood of confusion.</p>		
<b>Earlier sign</b>	<b>Contested sign</b>	<b>Case No</b>
NOBLESSE	NOBLISSIMA	22/07/2011, <a href="#">R 1257/2010-4</a>
<p>G&amp;S: Class 30</p> <p><i>Territory:</i> Denmark, Finland, Sweden</p> <p><i>Assessment:</i> the signs differ in the fifth letter and in their ending. They are visually similar to an average degree. In view of the length of the EUTM application, the signs differ in rhythm and intonation and are thus aurally similar to a low degree. The earlier signs 'NOBLESSE' do have a clear connotation in both Finland and Sweden. In these territories, the word 'NOBLISSIMA' lacks any meaning. They are, therefore, conceptually dissimilar. The earlier marks are laudatory in nature and to a certain extent descriptive of the characteristics of the goods 'chocolate', namely describing their superior character. The distinctive character is below average.</p>		
<b>Earlier sign</b>	<b>Contested sign</b>	<b>Case No</b>
ALBUMAN	ALBUNORM	01/02/2011, <a href="#">R 489/2010-2</a>
<p>G&amp;S: Class 5</p> <p><i>Territory:</i> EU</p> <p><i>Assessment:</i> visually, phonetically and conceptually the signs are similar insofar as they have the prefix 'ALBU' (abbreviation of 'albumin' or 'albumen') in common. But this similarity is of little significance because the prefix is generic and so devoid of distinctiveness. The second element of the earlier mark, 'MAN', is visually, phonetically and conceptually completely different from the second element, 'NORM', of the contested mark.</p>		

### 3.4.6.3 Short signs

The comparison of signs must be based on the **overall impression** given by the marks.

The length of signs may influence the effect of the differences between them. In principle, the shorter a sign, the more easily the public is able to perceive all its single

elements. In contrast, the public is usually less aware of differences between longer signs. **However, each case must be judged on its own merits, having regard to all the relevant factors.**

The Courts have not defined exactly what a short sign is. However, signs with three or less than three letters/numbers are considered by the Office as short signs. The paragraphs below thus analyse the impact on the overall impression, and thus, on the similarity of the respective signs for one-, two- and three-letter/number signs.

The comparison between signs consisting of a single letter or a combination of three or less than three letters not recognisable as a word, **follows the same rules** as that for word signs comprising a word, a name or an invented term (06/10/2004, [T-117/03](#) - [T-119/03](#) & [T-171/03](#), NL, EU:T:2004:293, § 47-48; 10/05/2011, [T-187/10](#), G, EU:T:2011:202, § 49).



#### Single-letter/Single-number signs

It follows from the case-law of the Court that in the assessment of likelihood of confusion between signs comprising the same single letter, the **visual comparison** (see [paragraph 3.4.1.7](#) ) is, in principle, decisive. Even where there is aural and conceptual identity, that identity may be overridden, in the assessment of likelihood of confusion, by sufficient visual differences between the signs (see the Guidelines, [Part C, Opposition, Section 2, Double Identity and Likelihood of Confusion, Chapter 7, Global Assessment, paragraph 7.1](#)).

#### Two-letter/number signs



The abovementioned rule on the importance of visual comparison applies to two-letter/number marks accordingly. The comparison of these signs depends on their stylisation and, especially, on whether the letters are recognisable as such in the sign. Consequently, the visual overall impression of the signs may be different when two conflicting signs, albeit containing or consisting of the same combination of two-letters, are stylised in a sufficiently different way or contain a sufficiently different figurative element, so that their different overall graphical representation eclipses the common verbal element.

In the following examples, the **marks were found visually similar** due to the graphic representations/visual similarities of the same two-letter combinations.

	Earlier sign	Contested sign	Case No
(i)			31/03/2000, <a href="#">B 61 046</a>
(ii)			

Earlier sign	Contested sign	Case No
<p>G&amp;S: Class 36</p> <p><i>Territory:</i> Spain</p> <p><i>Assessment:</i> the overall visual impression of the conflicting marks is that they consist of two letters in an arbitrary figurative design that conveys the same impression. The trade marks are considered similar.</p>		
Earlier sign	Contested sign	Case No
<p>GE</p>		<p>28/02/2014, <a href="#">T-520/11</a>, EU:T:2014:100</p>
<p>G&amp;S: Classes 6, 7, 9, 11, 17</p> <p><i>Territory:</i> UK</p> <p><i>Assessment:</i> it cannot be excluded that part of the relevant public will interpret the contested mark as the letter combination 'GE' (paras 33-35). The marks are phonetically identical and visually similar to a medium degree.</p>		

In the following example, **the signs were found visually and phonetically dissimilar** due to the different graphic representation and the fact that they may not be read as the same letters.

Earlier sign	Contested sign	Case No
<p>(i)</p>  <p>(ii)</p> 		<p>18/11/2011, <a href="#">R 82/2011-4</a></p>



G&S: Class 33

Territory: EU

*Assessment:* from a visual point of view, the graphic stylisation of the earlier marks is very different compared with the contested mark. The mere fact that one or both letters of the marks are identical is not enough to render the marks visually similar. There is no aural similarity if the contested mark will be pronounced as 'B' or 'PB' as in short signs differences have a higher impact on the overall impression than in longer marks. Conceptually, the contested mark and the earlier marks with no additional elements to the letter combination 'AB' do not have a meaning in any of the relevant languages: the conceptual comparison remains thus neutral (paras 17-19).

As to the difference in one of the letters see the following examples.

Earlier sign	Contested sign	Case No
(i) CX	KX	21/01/2011, <a href="#">R 864/2010-2</a>
(ii) 		

G&S: Class 7

Territory: EU

*Assessment:* visually, the initial letters 'K' and 'C' show a clearly different shape and can be considered only visually similar to a low degree. The same degree of similarity — low — applies for the phonetic comparison. Aurally, the signs will be pronounced 'K-X' and 'C-X' respectively, and not as words. Neither of the marks has a conceptual meaning (paras 25-27).

Earlier sign	Contested sign	Case No
KA		22/03/2011, <a href="#">T-486/07</a> , EU:T:2011:104

G&S: Classes 9, 11, 12

Territory: EU





*Assessment:* it must be concluded that, for each of the possible perceptions by the relevant public of the mark applied for, that public will perceive significant visual differences for each of the earlier marks (para. 65). Some degree of phonetic similarity between the marks at issue must be recognised, but it is not very high. Without making an error, the Board of Appeal, therefore, could find that the phonetic similarity between the marks at issue was not 'notable' (para. 71). As both marks have no meaning, no conceptual comparison can be made (para. 72).

Three-letter/number signs

When the signs in conflict are three-letter/number signs, a difference of one letter does not exclude similarity, especially if this letter is phonetically similar.

Earlier sign	Contested sign	Case No
	ELS	23/10/2002, EU:T:2002:260 <a href="#">T-388/00</a> ,
<p>G&amp;S: Classes 16, 35, 41</p> <p>Territory: Germany</p> <p><i>Assessment:</i> two of the three letters are identical and in the same sequence; the difference in a single letter does not constitute a significant visual and aural difference. The letters 'E' and 'I' in Germany are pronounced similarly (paras 66-71).</p>		
Earlier sign	Contested sign	Case No
Ran	R.U.N.	17/12/2009, <a href="#">T-490/07</a> , EU:T:2009:522
<p>G&amp;S: Classes 35, 38, 42</p> <p>Territory: EU, Germany</p> <p><i>Assessment:</i> the Court held that the signs in the mind of the relevant consumer, having a good command of the English language, are visually, aurally and conceptually similar (para. 55).</p>		

In contrast, when trade marks are composed of only three letters, with no meaning, the difference of one letter may be sufficient to render them not similar.

Earlier sign	Contested sign	Case No
<p>(i)</p>  <p>(ii)</p>  <p>(iii)</p> 		07/02/2001, <a href="#">R 393/1999-2</a>

Earlier sign	Contested sign	Case No
<p>G&amp;S: Class 25</p> <p><i>Territory:</i> Benelux, Germany, Spain, France, Italy, Portugal, Austria</p> <p><i>Assessment:</i> in this case the pronunciation of the first letters of the marks in dispute, i.e. 'J' and 'T', is different in all relevant languages. These letters are also visually dissimilar. Furthermore, the figurative elements of the compared marks do not resemble each other (paras 17-18).</p>		
Earlier sign	Contested sign	Case No
	COR	23/05/2007, <a href="#">T-342/05</a> , EU:T:2007:152
<p>G&amp;S: Class 3</p> <p><i>Territory:</i> Germany</p> <p><i>Assessment:</i> the GC considered that the signs were only aurally similar to a low degree (paras 47, 50). The relevant public in Germany will certainly notice the differences in the beginning of the signs.</p>		

#### 3.4.6.4 The impact of conceptual difference

Where at least one of the signs at issue has a clear and specific meaning that can be grasped immediately, the resulting conceptual difference may offset the visual and aural similarity between the signs (12/01/2006, [C-361/04](#), Picaro, EU:C:2006:25, § 20). This is the so-called principle of 'neutralisation'. That impact of conceptual difference is taken into consideration when making the overall assessment of similarity between the signs (05/10/2017, [C-437/16 P](#), CHEMPIOIL / CHAMPION et al., EU:C:2017:737, § 44; 04/03/2020, [C-328/18 P](#), BLACK LABEL BY EQUIVALENZA (fig.) / LABELL (fig.) et al., EU:C:2020:156, § 75).



Not just any conceptual dissimilarity can lead to neutralisation. Neutralisation can only be applied exceptionally, if at least one of the signs **as a whole** has a **clear and specific meaning that can be grasped immediately** by the relevant public.

Earlier sign	Contested sign	Case No
	CHEMPIOIL	05/10/2017, <a href="#">C-437/16 P</a> , EU:C:2017:737

Earlier sign	Contested sign	Case No
<p>G&amp;S: Classes 1, 3 and 4</p> <p><i>Territory:</i> European Union</p> <p><i>Assessment:</i> The word ‘champion’ has a clear and specific meaning that will be understood by the relevant public, as it is used extensively in various fields of daily life, such as the arts, literature, cinema, music or sport. Whilst the term ‘chempioil’ alludes to oil or chemicals, it does not convey any clear meaning for the sign as a whole. Despite the visual and phonetic similarities between the signs, the consumer would make a distinction between them due to the clear concept conveyed by the earlier sign. Consequently, the visual and aural similarities of the signs at issue are offset by the conceptual difference conveyed by the meaning of the term ‘champion’ (§ 31, 46-47 and 55).</p>		

Where neither of the signs as a whole has a clear and specific meaning, any conceptual difference between the signs that may result from a vague concept that the sign may evoke is insufficient to offset the visual and aural similarities.

Earlier sign	Contested sign	Case No
MUNDICOLOR	MUNDICOR	17/03/2004, <a href="#">T-183/02</a> & <a href="#">T-184/02</a> , EU:T:2004:79
<p>G&amp;S: Class 2</p> <p><i>Territory:</i> Spain</p> <p><i>Assessment:</i> Whilst ‘MUNDICOLOR’ is to a certain extent evocative of ‘colours of the world’ or ‘the world in colours’ for the Spanish public, it cannot be regarded as having any clear and specific meaning. In the mark applied for, the same prefix, ‘mundi’, is accompanied by the suffix ‘cor’, a term that has no meaning in Spanish. Therefore, notwithstanding the evocative nature of the prefix ‘mundi’ (world), the latter sign is ultimately devoid of any concept for the Spanish public. As neither of the signs has a clear and specific meaning likely to be grasped immediately by the public, any conceptual difference between them is not such as to counteract their visual and aural similarities (§ 90-99) — likelihood of confusion.</p>		

Earlier sign	Contested sign	Case No
		04/03/2020, <a href="#">C-328/18 P</a> , EU:C:2020:156
<p>G&amp;S: Class 3</p> <p><i>Territory:</i> Czech Republic, Hungary, Poland and Slovenia</p> <p><i>Assessment:</i> Conceptually, the relevant public is not familiar with the meaning of the English word 'label', so the earlier mark will be perceived as consisting of a fanciful word devoid of meaning. However, they will understand the adjective 'black', which is a basic word in English, as a description of a colour, and will also be able to understand the words 'by equivalenza' as indicating that the goods in question come from Equivalenza Manufactory. Furthermore, the signs are visually and aurally similar to an average degree. However, as neither of the signs (as a whole) has a clear and specific meaning that can be grasped immediately by the relevant public, the conceptual differences between the signs cannot offset the similarities in the other aspects, and a global assessment has to be carried out (§ 76-77, 97 and 99) — likelihood of confusion.</p>		

Furthermore, for neutralisation to apply, the meaning of the sign must be clear and specific for **the entire public** for whom the signs are visually and phonetically similar. If neither of the signs has a clear and specific meaning that could be grasped immediately by a significant part of the public, neutralisation is not appropriate, notwithstanding the fact that for another part of the public at least one of the signs had such a meaning.

Earlier sign	Contested sign	Case No
TAIGA	tigha	13/09/2018, <a href="#">T-94/17</a> , EU:T:2018:539 (confirmed 16/07/2020, <a href="#">C-714/18 P</a> , EU:C:2020:573, § 75-77)

Earlier sign	Contested sign	Case No
<p>G&amp;S: Classes 18, 25</p> <p><i>Territory:</i> European Union</p> <p><i>Assessment:</i> The contested mark 'tigha' has no meaning for the relevant public. As for the earlier mark, it is likely that the relevant public in the northern and eastern parts of the European Union will immediately perceive the word 'taiga' as referring to a boreal forest. However, this could not be established for the relevant public elsewhere in the European Union. The alleged 'evident conceptual differences' have not been established throughout the European Union. Taking account of the visual and phonetic similarity of the signs at issue, their lack of clear and specific meaning for a significant part of the relevant public, and the similarity or identity of the goods concerned, there was a likelihood of confusion (§ 67-71, 77, 80) — likelihood of confusion.</p>		

However, even if at least one of the signs does have a clear and specific meaning that could be grasped immediately by the entire relevant public, the visual or aural similarity may be so high that the resulting conceptual differences could still not be offset.

Earlier sign	Contested sign	Case No
INTESA	INTEA	13/04/2005, <a href="#">T-353/02</a> , EU:T:2005:124
<p>G&amp;S: Classes 3, 21</p> <p><i>Territory:</i> Italy (among other EU member states)</p> <p><i>Assessment:</i> Although the word 'intesa' means agreement or contract in Italian, it refers to an abstract concept that, in the context of the goods at issue, is unlikely to create a strong association capable of facilitating memorisation of the sign on the basis of that meaning. In addition, it is possible that, owing to the strong visual and aural similarities between the signs, this conceptual difference will escape the attention of the relevant Italian public. In the present case, the inherent concept of the earlier mark is incapable of offsetting the similarities between the signs (§ 34) — likelihood of confusion.</p>		

### 3.5 Conclusion on similarity

An assessment of similarity between two marks means more than taking just one component of a composite trade mark and comparing it with another. The comparison must be made by examining each of the marks in question as a whole. However, this does not mean that the overall impression conveyed by a composite trade mark may not, in certain circumstances, be dominated by one or more of its components. In

general, the more features the marks have in common, the higher the degree of similarity.

The conclusion reached on the similarity between the signs is the result of an evaluation of all of the relevant factors discussed in detail above.

It must also be borne in mind that since the assessment of similarity is based on the overall impression of the signs, once signs have been found to be similar, it would not be consistent to find later, in the global assessment of the likelihood of confusion, that ‘the overall impression of the signs is different’ in order to support an outcome of no likelihood of confusion.



In general, the following should be considered when assessing similarity and degrees of similarity.

#### Impact of the distinctiveness of the elements

The greater or lesser degree of distinctiveness of the common elements of the signs is one of the relevant factors in assessing the similarity between signs.

For example, if the coincidences between the signs on any of the three aspects of comparison derive from an element with limited distinctiveness, the established degree of visual, aural and/or conceptual similarity, respectively, will be lower than where the elements in common have a normal distinctiveness.

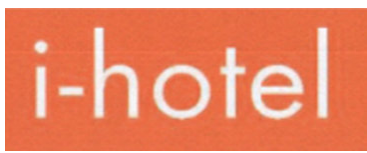
In the following examples the signs involved weak/descriptive elements but with different outcomes.

Earlier sign	Contested sign	Case No
		13/06/2012, <a href="#">T-277/11</a> , EU:T:2012:295 (likelihood of confusion)
<p>G&amp;S: Classes 35, 39, 41, 42 and 43</p> <p><i>Territory:</i> EU</p> <p><i>Assessment:</i> the Court found the signs visually highly similar, and identical phonetically and conceptually (paras 86, 88, 91 and 93).</p>		
Earlier sign	Contested sign	Case No

Earlier sign	Contested sign	Case No
	TRIDENT PURE	16/12/2015, <a href="#">T-491/13</a> , EU:T:2015:979 (No likelihood of confusion)
<p>G&amp;S: Class 30</p> <p><i>Territory:</i> inter alia EU</p> <p><i>Assessment:</i> The Court established a low degree of visual similarity given that the coinciding element 'PURE', despite being descriptive for part of the public, was not on its own sufficient to conclude that the word is negligible in the overall impression produced by the mark (paras 69-71). Aurally, the marks were deemed similar to a low degree for those who understood the non-distinctive meaning of 'PURE' but to an average degree for the remaining part of the public (para. 87). Conceptually, they are similar for those who understand 'PURE' as a descriptive term referring to the purity of the goods at issue and to the purity of breath. The fact that the word 'pure' is descriptive of the characteristics of the goods in question does not alter the conceptual content of the marks (para. 93).</p>		

### Impact of the dominant elements

The conclusion on similarity also has to take into account whether the common element is dominant (visually outstanding) or at least codominant in the overall impression of the marks.



It should also be noted that where some elements of a trade mark are descriptive or non-distinctive, they are not generally regarded by the public as being dominant in the overall impression conveyed by that mark, unless, particularly because of their position or their size, they appear likely to make an impression on consumers and to be remembered by them.

It should be emphasised that the abovementioned factors may not be applicable to all cases and the assessment of similarity is always undertaken on a case-by-case basis and a consideration of further factors may be necessary. Furthermore, it should be noted that the above factors and principles do not call into question the principle that the examination of the similarity of trade marks must take into account the overall impression produced by them on the relevant public.

### Impact of word versus figurative elements

When signs consist of both verbal and figurative components, in principle, the verbal component of the sign usually has a stronger impact on the consumer than the figurative component.



Earlier sign	Contested sign	Case No
		16/01/2014, <a href="#">T-149/12</a> , EU:T:2014:11 (likelihood of confusion)
<p>G&amp;S: Class 9</p> <p>Territory: Spain</p> <p>Assessment: the signs were found visually highly similar and phonetically identical, notwithstanding the descriptive character of the element 'MICRO' (paras 54-55, 60) and taking into account that the differences were limited to banal graphical elements.</p>		

In general, the identity or similarity of the figurative component of the signs is insufficient to establish a considerable degree of similarity where at least one of the signs contains a further verbal component that is not contained in the other sign.

However, although the word elements of a mark may have a greater impact, this is not necessarily the case where the figurative element visually dominates the overall impression made by the mark (see [paragraph 3.4.6.1](#) above).

#### Beginning of signs



In principle, coincidences at the beginning of signs increase their similarity more than coincidences in the middle or at the end of signs.

Therefore, consumers attach less importance to the end of the mark and coincidences located at the end of signs would lead to a finding of a lower degree of visual similarity than common elements at the beginning of signs (see first example below). Likewise, the position of the coinciding/similar phonemes or syllables at the beginning of the conflicting signs would increase the degree of aural similarity.

However, the degree of similarity will usually be lower, despite identical beginnings, if those are the weak elements in the signs or if the remaining elements have a clearly different meaning (see second example below).

Earlier sign	Contested sign	Case No
OXYGESIC	Maxigesic	16/10/2013, <a href="#">T-328/12</a> , EU:T:2013:537

Earlier sign	Contested sign	Case No
<p>G&amp;S: Class 5</p> <p>Territory: EU</p> <p>Assessment: the signs were found visually similar to a low degree due to the descriptive character of the suffix 'GESIC', given that it refers to painkillers (paras 35, 47), as well as the different beginnings (para. 49). Phonetically, they were found similar to an average degree (para. 51) and conceptually dissimilar, the latter again due to the descriptive content of 'GESIC' and the differing associations that could be made with the respective prefixes of the signs ('OXY' refers to oxygen/oxycodon and 'MAXI' to maximum (para. 53)), with the result that a likelihood of confusion was excluded.</p>		

Earlier sign	Contested sign	Case No
		05/02/2015, EU:T:2015:77
<p>G&amp;S: Class 35, 36 and 42.</p> <p>Territory: Austria, Benelux, Bulgaria, the Czech Republic, Cyprus, Denmark, Estonia, Finland, France, Germany, Greece, Hungary, Italy, Latvia, Lithuania, Poland, Portugal, Slovakia, Slovenia, Spain, Sweden and the United Kingdom.</p> <p>Assessment: visually, the signs were deemed to have at least a certain degree of visual similarity, even if the coincidence in 'bonus' related to an element of a weak distinctive character (paras 32, 41). Phonetically, the signs were found similar to an average degree due to the identical pronunciation of the first two syllables (para. 34). Conceptually, there is at least a certain degree of similarity for a significant part of the public for whom the common element 'bonus' conveys an identical meaning (para. 42).</p>		

### Short signs

The length of the signs may influence their overall impression and thus the effect of the differences between them. In principle, the shorter a sign is, the more easily the public is able to perceive all its single elements. In contrast, the public is usually less aware of differences between longer signs.

The application of the abovementioned principles and factors should not be automatic. The decision has to explain their relevance for the particular case and weigh them up.

However, the rules explained in this chapter have a general character and the particularities of a specific case may justify different findings. However, in such cases it is of even greater importance to provide a clear and thorough reasoning in the decision.

## 4 Dissimilarity of Signs

### 4.1 Introduction

The similarity of signs is a necessary condition for a finding of a likelihood of confusion under [Article 8\(1\)\(b\) EUTMR](#). An assessment of the similarity between two marks must be based on the **overall impression** created by them, in particular, by their distinctive and dominant components (23/10/2002, [T-6/01](#), Matratzen + Matratzenmarkt Concord (fig.), EU:T:2002:261, § 32 and the case-law cited). Where the overall impression is that the signs are dissimilar, this excludes the likelihood of confusion.

The finding as to whether signs are similar or dissimilar overall is the result of a combined assessment of (i) the visual, phonetic, conceptual overlaps and differences and (ii) the significance of the overlaps and differences in the perception of the relevant public.

The finding that the signs are dissimilar has the following consequences.

- The goods and services are not compared.
- Any claim of enhanced distinctiveness is not examined. If the signs are dissimilar, the opposition under [Article 8\(1\)\(b\) EUTMR](#) must be rejected regardless of any enhanced distinctiveness of the earlier mark. Where the marks in question are not similar, there is no need to take account of the reputation of the earlier mark, since it does not fall within the scope of the test of similarity and cannot serve to increase the similarity between those marks (14/03/2011, [C-370/10 P](#), EDUCA Memory game, EU:C:2011:149, § 50-51 and the case-law cited).
- There is no global assessment of factors. The decision concludes that in the absence of one of the conditions, the opposition under [Article 8\(1\)\(b\) EUTMR](#) must be rejected.
- The signs will be considered dissimilar also for the purposes of other grounds of opposition. In particular, any claim under [Article 8\(5\) EUTMR](#) will be rejected (see the Guidelines, [Part C, Opposition, Section 5, Trade Marks with Reputation \(Article 8\(5\) EUTMR\), paragraph 3.2](#)).

### 4.2 Scenarios for dissimilarity

#### 4.2.1 No element in common



The signs are obviously dissimilar if they have nothing in common in any of the three aspects of comparison. This is more a hypothetical scenario as the signs at issue in an opposition under [Article 8\(1\)\(b\) EUTMR](#) normally have something in common. What is rather debated by the parties is the significance of the overlap in an element.

#### 4.2.2 Overlap in a negligible element

The signs are dissimilar if the only element they have in common is **negligible** in one or both of the marks in the sense that, due to its size and/or position, it will be likely to go **unnoticed** or **disregarded** by the relevant public. Negligible elements, after **having duly reasoned** why they are considered negligible, will not be compared (12/06/2007, [C-334/05 P](#), Limoncello, EU:C:2007:333, § 42). The notion of negligible elements should be strictly interpreted and, in the event of any doubt, the assessment should cover all the elements of the sign (see [paragraph 1.2](#) above).

Concerning the assessment as to whether an element is negligible, the test is not whether the Office can, in a meticulous side-by-side examination of the signs, decipher the element concerned. The question is rather whether, in the overall impression of the sign, the element is noticeable by the average consumer who normally perceives a sign as a whole and does not proceed to analyse its various details.

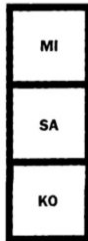
#### Examples

Earlier sign	Contested sign	Case No
		11/11/2009, <a href="#">T-162/08</a> , EU:T:2009:432  The words 'by missako' are almost illegible: the size and script make them difficult to decipher
 (RL RÓTULOS LUNA S.A.)	LUNA	12/12/2011, <a href="#">R 2347/2010-2</a>  The element 'Rótulos Luna S.A.' was considered negligible

#### 4.2.3 Overlap in a verbal element not noticeable due to high stylisation

The signs are dissimilar if the verbal element, which would give rise to similarity, is not discernible due to its high stylisation. Sometimes the way in which letters or symbols are used makes it unrealistic to assume that they will be read and pronounced, for example, when in a figurative mark a symbol or letter is repeated in order to create a pattern, is highly distorted or otherwise not clearly legible. If the verbal element is not recognisable in the overall impression of the sign, thus, not legible and not pronounceable, it will not be taken into account in the comparison.

Again, the test is not whether the Office can, in a meticulous side-by-side examination of the signs, identify the verbal element concerned. It is irrelevant if the verbal element is recognised only with the help of the other mark, as the consumer normally does not have the opportunity to compare signs side by side. Furthermore, it is irrelevant that the party refers to its mark by a particular verbal element in its submissions or if the particulars of the mark indicate a verbal element, because the consumer will not be assisted by that information on encountering the sign as registered or applied for.

#### Examples

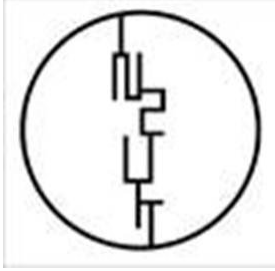
Earlier sign	Contested sign	Case No
KA		22/06/2011, <a href="#">R 1779/2010-4</a>
<b>intuit</b>		17/09/2015, <a href="#">R 164/2015-2</a>

The question whether the verbal element is indeed ‘lost’ in the stylisation must be carefully assessed. The consumer intuitively looks for pronounceable elements in figurative signs by which the sign can be referred to. The high stylisation of one or more letters of a word may not prevent the consumer from identifying the verbal element as a whole, particularly, if it suggests a concrete meaning. It should also be emphasised that if the complex stylisation of the verbal element of a sign does not make it totally illegible, but merely lends itself to various interpretations, the comparison must take into account the different realistic interpretations. Thus, it is only in the — rather rare — case where the legibility of the sign is truly unrealistic, without being assisted by a mark description or the other mark, that the verbal element will be disregarded in the comparison.



#### 4.2.4 Overlap in other irrelevant aspects

The fact that there is some coincidence between the signs does not necessarily lead to a finding of similarity. This is in particular the case when the overlapping part is not perceived independently within the overall impression of the marks. The Court considered the following signs dissimilar despite the overlap in a sequence of letters.





#### Examples

Earlier sign	Contested sign	Case No
StoCretec	CRETEO	28/01/2016, EU:T:2016:38 <a href="#">T-640/13</a> ,
<p>The conflicting signs are dissimilar (para. 87). In the visual impression created by the marks, the beginnings 'sto' and 'cre' and the endings 'tec' and 'o' play a more important role than the syllables 'cre' and 'te', which are placed in the middle of the signs and are less perceived by the relevant public. Therefore, it is concluded that there is no visual similarity between the signs (para. 71). The marks are not phonetically similar, in particular on account of their different beginnings and endings (para. 72). The conceptual comparison remains neutral, as 'StoCretec' and 'CRETEO' are coined terms without any meaning in German (para. 73).</p>		

Earlier sign	Contested sign	Case No
ALDI		26/11/2014, EU:T:2014:994 <a href="#">T-240/13</a> ,
<p>The figurative elements and the additional word 'foods' must not be disregarded when comparing the signs (paras 54-55). The overall visual impression of the conflicting signs is clearly dissimilar (paras 59-61). The signs are not phonetically similar bearing in mind, in particular, the additional element 'foods' of the contested mark (paras 65-66). Finally, the marks are also conceptually not similar (para. 73).</p>		

Earlier sign	Contested sign	Case No
		12/11/2014, EU:T:2014:944 <a href="#">T-524/11</a> ,
<p>The figurative elements of the earlier figurative marks further distinguish those marks from the mark applied for (para. 36). The signs at issue have a different rhythm of pronunciation (paras 43-44). The words have no meaning; it is not possible to carry out a conceptual comparison (para. 54).</p>		

The same applies to similarities in the figurative elements that are of minor impact.

Earlier sign	Contested sign	Case No
		16/07/2014, <a href="#">T-36/13</a> , EU:T:2014:673
The figurative elements of the signs have the same outline, but will be perceived as different by the relevant public (paras 45-47). The word elements are visually different since they have only two letters in common, which are also placed in distinct positions.		
Earlier sign	Contested sign	Case No
		22/03/2012, <a href="#">B 1 837 106</a>
The marks coincide only in that the verbal elements are written in white on a contrasting grey background and the white frame that separates the verbal and the landscape elements in equal parts. These are commonplace figurative elements, omnipresent in marks in virtually all fields of trade. The consumer's attention is not caught by any of these details, but rather by the fanciful term 'tukas' in the earlier mark and by the word 'Ekonomik' in the contested mark. As the signs visually overlap only in irrelevant aspects and have nothing in common aurally and conceptually, they are dissimilar overall.		

The decision must contain a thorough reasoning, in the comparison of signs, as to why the overlap in particular aspects is considered irrelevant.

#### 4.2.5 Overlap in a non-distinctive element

If the signs overlap exclusively in an element that is **descriptive** or **non-distinctive** for the relevant goods and services in all parts of the relevant territory, and both **contain other distinctive element(s) capable of differentiating** between the signs, they can be considered dissimilar.

It follows that two conditions have to be fulfilled in order to find dissimilarity in this context:

- the coinciding element must be non-distinctive (if the coinciding element has some, even very low distinctiveness, the signs cannot be found dissimilar);
- both signs must contain other elements that are distinctive and capable of differentiating the marks.

Therefore, two signs may be dissimilar for some of the goods and services but not for others. In such a case, strategy may justify comparing some of the goods and services

to find them dissimilar, and then continuing with the assessment of the similarity of the signs for the remaining goods and services only.

Furthermore, if in part of the relevant territory the overlapping element is not perceived as descriptive or non-distinctive (e.g. due to non-understanding of the term), the signs cannot be considered dissimilar.

The following invented examples illustrate cases where the coincidence in one element cannot lead to any similarity because that element is non-distinctive and the other elements, which are clearly different, allow the public to differentiate sufficiently between the marks.

Earlier sign	Contested sign
HOTEL FRANCISCO	HOTEL ZENITH
G&S: provision of accommodation <i>Territory:</i> EU	
CASA ENRIQUE	CASA RACHEL
G&S: provision of restaurant services <i>Territory:</i> Spain (where 'casa' has also the meaning 'bar', 'restaurant')	
MARKET.COM	FITNESS.COM
G&S: telecommunications services <i>Territory:</i> EU	



#### Examples from case-law

Earlier sign	Contested sign	Case No
	CARBON CAPITAL MARKETS	22/06/2010, <a href="#">T-563/08</a> , EU:T:2010:251 (paras 39-61)
G&S: Class 36 <i>Territory:</i> EU (relevant public considered to be familiar with basic English financial terminology) <i>Assessment:</i> the common element 'capital markets' directly describes the services.		

According to the rules established above, despite a lack of distinctive character of the elements in common, it would **not** be appropriate to conclude on dissimilarity, where:



- the particular combination of the elements confer some distinctiveness on the signs (i.e. the combination would be protected)

Earlier sign	Contested sign	Case No
		22/05/2012, EU:T:2012:252 <a href="#">T-60/11</a> ,
<p>G&amp;S: Classes 30, 31, 42</p> <p>Territory: EU</p> <p>Assessment: there is some similarity between the marks. The earlier mark consists of two elements that are non-distinctive for the goods in question — the image of a corn (descriptive for bakery products) and the laudatory word element 'PREMIUM'. The combination of these elements is arbitrary (unlike the word combination 'Capital markets' in the example above, which is an established expression). The coincidences between the marks are therefore not limited to non-distinctive elements but extend to their particular combination.</p>		

- the other element that is supposed to distinguish between the signs is perceived as an insignificant figurative detail, or is otherwise non-distinctive (see [paragraph 3.2.3.1](#) above)

Earlier sign	Contested sign	Case No
	iHotel	13/06/2012, EU:T:2012:295 <a href="#">T-277/11</a> ,
<p>G&amp;S: services related to travel, accommodation and congresses in Classes 35, 39, 41, 42, 43</p> <p>Territory: EU</p> <p>Assessment: the visual differences between the marks (the orange background and the particular way of writing) do not distract from the common element. The marks are visually highly similar and aurally and conceptually identical (paras 83-92).</p>		

Earlier sign	Contested sign	Case No
waterPerfect	AquaPerfect	28/01/2015, EU:T:2015:52 <a href="#">T-123/14</a> ,

Earlier sign	Contested sign	Case No
<p>G&amp;S: Class 7</p> <p>Territory: EU</p> <p><i>Assessment:</i> while the element 'Perfect' has weak distinctive character, the fact remains that none of the other elements can be considered to have greater distinctive character. The elements 'aqua' and 'water' also have weak distinctive character as they will be perceived by the relevant public as meaning 'water' and the goods covered all involve water in one way or another (para. 42).</p> <p>The signs were found visually, phonetically and conceptually similar to an average degree.</p>		

- the non-distinctive elements constituting (forming exclusively) the sign are entirely incorporated in the other sign

Earlier sign	Contested sign	Case No
POST	TPG POST	13/05/2015, <a href="#">T-102/14</a> , EU:T:2015:279
<p>G&amp;S: Class 39 and others related to postal services</p> <p>Territory: Germany, EU</p> <p><i>Assessment:</i> although the element 'post' as such is non-distinctive for postal services, it corresponds to the earlier mark, which should be attributed with a minimum degree of distinctiveness (para. 43).</p>		

In summary, the finding of 'dissimilar overall' on account of an overlap exclusively in non-distinctive elements should be limited to evident cases where the other element serves to safely distinguish between the signs.

In less evident cases low similarity should be attributed to the marks. The examination will then proceed and the cases will be solved at the stage of the global assessment (see the Guidelines, [Part C, Opposition, Section 2, Double Identity and Likelihood of Confusion, Chapter 7, Global Assessment, paragraph 6.2](#)).

***GUIDELINES FOR EXAMINATION OF  
EUROPEAN UNION TRADE MARKS***

***EUROPEAN UNION  
INTELLECTUAL PROPERTY OFFICE  
(EUIPO)***

***Part C***

***Opposition***

***Section 2***

***Double identity and likelihood of confusion***

***Chapter 5***

***Distinctiveness of the earlier mark***

## Table of Contents

<b>1 General Remarks.....</b>	<b>1102</b>
<b>2 Assessment of Distinctiveness of the Earlier Mark.....</b>	<b>1103</b>
2.1 General issues.....	1103
2.1.1 Distinctiveness.....	1103
2.1.2 Inherent and enhanced distinctiveness.....	1105
2.1.3 Relevant point in time.....	1106
2.1.4 Relevant goods and services.....	1106
2.2 Examination of inherent distinctiveness of the earlier mark.....	1106
2.2.1 General principles.....	1106
2.2.2 Impact of the low distinctiveness of the earlier mark.....	1107
2.2.3 Specific themes.....	1109
2.3 Examination of enhanced distinctiveness.....	1111

## 1 General Remarks

The Court of Justice of the European Union (the Court) held in its judgment of 29/09/1998, [C-39/97](#), Canon, EU:C:1998:442, § 18, 24:

... marks with a highly distinctive character, either per se or because of the reputation they possess on the market, enjoy broader protection than marks with a less distinctive character.

... the distinctive character of the earlier trade mark, and in particular its reputation, must be taken into account when determining whether the similarity between the goods or services covered by the two trade marks is sufficient to give rise to the likelihood of confusion.

The assessment of the distinctiveness of an earlier mark is **especially** important in cases when there is only a low degree of similarity between the signs, as it must be assessed whether this low degree can be compensated by the high degree of similarity between the products (11/06/2014, [T-281/13](#), Metabiomax, EU:T:2014:440, § 57; 13/05/2015, [T-102/14](#), TPG POST / DP et al., EU:T:2015:279, § 67) and vice versa.

According to case-law, it is necessary to distinguish between the **notion of the distinctive character of the earlier mark, which determines the protection afforded to that mark**, and the **notion of the distinctive character which an element of a composite mark possesses, which determines its ability to dominate the overall impression created by the mark** (27/04/2006, [C-235/05 P](#), Flexi Air, EU:C:2006:271, § 43). While it is true that it is necessary to examine the **distinctiveness of an element of a composite mark at the stage of assessing the similarity of the signs (...)**, **the degree of distinctiveness of the earlier mark is an element to be taken into account in the context of the global assessment of the likelihood of confusion**. It is therefore not appropriate to take account of what may be a low degree of distinctiveness of the earlier mark at the stage of assessing the similarity of the signs (23/01/2014, [C-558/12 P](#), WESTERN GOLD / WeserGold et al., EU:C:2014:22, § 42-45; 25/03/2010, T-5/08 & [T-7/08](#), Golden Eagle / Golden Eagle Deluxe, EU:T:2010:123, § 65; 19/05/2010, [T-243/08](#), EDUCA Memory game, EU:T:2010:210, § 27).

The Office therefore distinguishes between: (i) the analysis of the distinctive character of the earlier mark as a whole, which determines the scope of protection afforded to that mark and is one of the factors in the global assessment of the likelihood of confusion, and (ii) the analysis of the distinctive character of a component of the marks within their comparison.<sup>(62)</sup>

Whereas distinctive character must be assessed for the components of both the earlier mark and the contested mark, distinctiveness of the mark as a whole is assessed only in respect of the earlier mark.<sup>(63)</sup> The distinctiveness of the contested mark as a whole

<sup>62</sup> See the Guidelines, [Part C, Opposition, Section 2, Double Identity and Likelihood of Confusion, Chapter 4, Comparison of Signs](#).

<sup>63</sup> See also Objective 1 of the Common Practice on the impact of non-distinctive/weak components on likelihood of confusion agreed within the framework of the European Trade Mark and Design Network (ETMDN).

is not relevant, as such, to the assessment of the likelihood of confusion, as explained in more detail in [paragraph 2.1.2](#) below. Therefore, any reference below to the distinctiveness of the mark **as a whole** refers exclusively to the earlier mark.

## 2 Assessment of Distinctiveness of the Earlier Mark

The *Canon* judgment makes clear that (i) the more distinctive the earlier mark, the greater will be the likelihood of confusion, and (ii) earlier marks with a highly distinctive character because of the reputation they possess on the market, enjoy broader protection than marks with a less distinctive character. Consequently, the distinctive character of the earlier mark as a whole determines the strength and breadth of its protection and must be taken into consideration for the purposes of assessing the likelihood of confusion.

### 2.1 General issues

#### 2.1.1 Distinctiveness

The Court has defined distinctiveness in the following manner.

In determining the distinctive character of a mark and, accordingly, in assessing whether it is highly distinctive, the national court must make an overall assessment of the **greater or lesser capacity of the mark to identify the goods or services for which it has been registered as coming from a particular undertaking, and thus to distinguish those goods or services from those of other undertakings** (emphasis added).

(22/06/1999, [C-342/97](#), *Lloyd Schuhfabrik*, EU:C:1999:323, § 22).

Importantly, distinctive character is a matter of degree and, when analysing distinctiveness, a sliding scale applies, whereby a sign can lack distinctiveness entirely, be highly distinctive or be at any point in between.

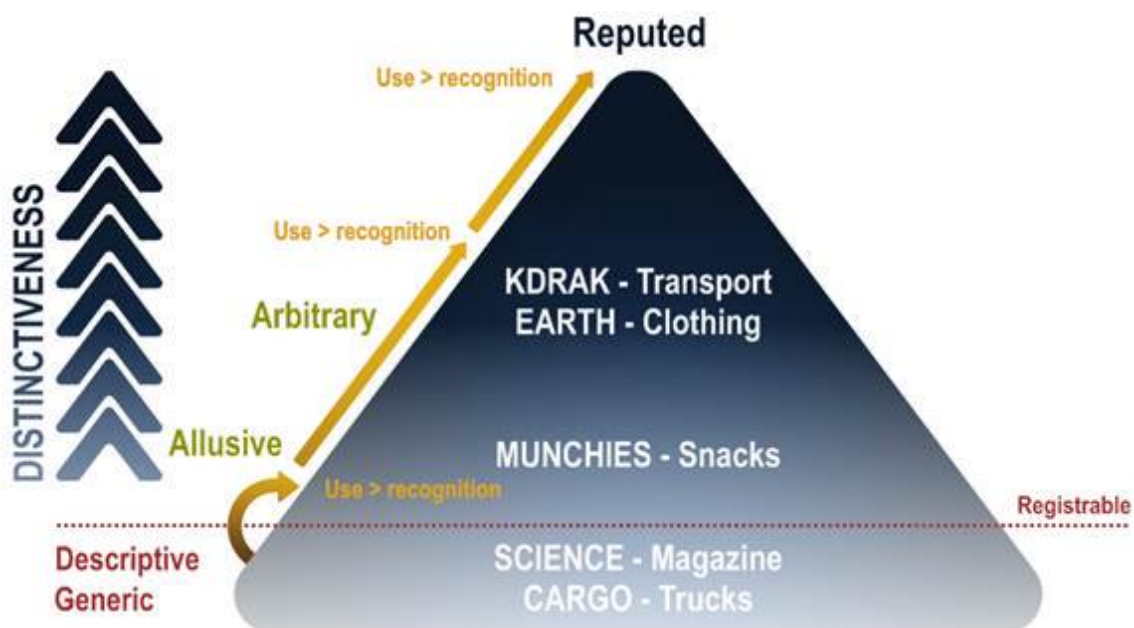

A sign is **not distinctive** if it is descriptive of the goods and services themselves or of the characteristics of those goods and services (such as their quality, value, purpose, provenance, etc.), laudatory and/or if its use in trade is common for those goods and services. Similarly, a sign that is generic (such as a common shape of a container or a common colour) will also lack distinctiveness. The rules for the assessment of distinctive character follow those established by examination on absolute grounds.

A sign may be **distinctive to a low degree** if it alludes to (but is not exclusively descriptive of) characteristics of the goods and services. If the allusion to the goods and services is sufficiently imaginative or clever, the mere fact that there is an allusion to characteristics of the goods and/or services might not materially affect distinctiveness. For example:

- ‘Billionaire’ for *gaming services* is allusive in a manner that would affect distinctiveness because it implies, for instance, that you may become a billionaire.
- ‘Billy O’Naire’, which sounds identical to ‘billionaire’ in English, would be allusive for *gaming services* as a clever wordplay on Irish names, in a manner that would not affect distinctiveness in a material way; it would be considered to have a ‘normal’ degree of distinctiveness.

A sign is deemed to possess a **‘normal’ degree of inherent** distinctiveness if there is no indication for a limitation thereof (e.g. due to a descriptive character, laudatory meaning, etc.). This means that the sign in question is fully distinctive, in the sense that its capacity to identify the goods and services for which it has been registered as coming from a particular undertaking is not in any way diminished or impaired.

Any **higher degree of distinctiveness** acquired by the earlier mark, which is often claimed by the opponent in order to broaden its scope of protection, has to be proven by its proprietor by submitting appropriate evidence (see [paragraph 2.3](#) below). A mark will not automatically have a higher degree of distinctive character just because there is no conceptual link to the relevant goods and services (16/05/2013, [C-379/12 P](#), H.EICH / H SILVIAN HEACH, EU:C:2013:317, § 71).

However, an EUTM applicant may argue that the earlier sign is distinctive to a low degree. One of the most frequent arguments brought by applicants is that the earlier trade mark or one of its components has low distinctive character given that there are many trade marks that consist of, or include, the element in question. Where this argument is supported only by the applicant referring to trade mark registrations, the Office takes the view that the existence of several trade mark registrations is not per se particularly conclusive, as it does not necessarily reflect the situation in the market. In other words, on the basis of register data only, it cannot be assumed that all the trade marks have been effectively used (13/04/2011, [T-358/09](#), Toro de Piedra, EU:T:2011:174, § 35; 08/03/2013, [T-498/10](#), David Mayer, EU:T:2013:117, § 77-79).

It follows that the evidence filed must demonstrate that consumers have been exposed to widespread use of, and become accustomed to, trade marks that include the element in question in order to prove that this element has a low degree of distinctive character.

When dealing with the distinctiveness of the **earlier mark as a whole**, the latter should always be considered **to have at least a minimum degree of inherent distinctiveness**. Earlier marks, whether EUTMs or national marks, enjoy a 'presumption of validity'. The Court made it clear, in its judgment of 24/05/2012, [C-196/11 P](#), F1-Live, EU:C:2012:314, § 40-41, that 'in proceedings opposing the registration of a European Union trade mark, the validity of national trade marks may not be called into question'. The Court added that 'it should be noted that the characterisation of a sign as descriptive or generic is equivalent to denying its distinctive character'.<sup>(64)</sup>

### 2.1.2 Inherent and enhanced distinctiveness

The Office must consider, as a first step, the overall **inherent distinctiveness** of the earlier mark (see [paragraph 2.2](#) below) and, as a second step, if claimed and relevant to the outcome, whether the earlier mark has **acquired enhanced distinctiveness** as a consequence of the use the opponent has made of it (see [paragraph 2.3](#) below).

The degree of distinctiveness of the earlier sign is one of the factors to be taken into account in the overall assessment (11/11/1997, [C-251/95](#), Sabèl, EU:C:1997:528, § 23). It is a matter of law which must be examined by the Office even if the parties do not comment on it. In contrast, the degree of enhanced distinctiveness acquired through use of the earlier sign is a matter of law **and** fact, which the Office cannot examine unless the opponent claims and substantiates it in due time (see the Guidelines, [Part C, Opposition, Section 1, Opposition Proceedings, paragraph 4.2, Substantiation](#)).

The inherent distinctiveness of the **contested** trade mark **as a whole** is not examined within the framework of the opposition proceedings, as it is the scope of protection of the earlier mark that is relevant for the purposes of likelihood of confusion. Likewise, the enhanced distinctiveness of the contested sign is also irrelevant because likelihood

<sup>64</sup> See also Objective 1 of the Common Communication on the Common Practice of Relative Grounds of Refusal – Likelihood of Confusion (Impact of non-distinctive/weak components) (CP5)



of confusion requires a consideration of the scope of protection of the earlier mark rather than that of the mark applied for. If an earlier mark is recognised as having a broader scope of protection by reason of its enhanced distinctiveness, the reputation acquired by the **mark applied for** is, as a matter of principle, irrelevant for the purpose of assessing the likelihood of confusion (03/09/2009, [C-498/07 P](#), La Española, EU:C:2009:503, § 84).

### 2.1.3 Relevant point in time

The inherent distinctiveness of the earlier mark(s) should be assessed at the time of the decision. The enhanced distinctiveness of the earlier trade mark(s) (if claimed) should exist (i) at the time of filing of the contested EUTM application (or any priority date), **and** (ii) at the time of the decision.

### 2.1.4 Relevant goods and services

The assessment of the **inherent distinctiveness** of the earlier mark is carried out only for the goods or services that have been found to be identical or similar to the contested goods and services.

Assessment of the **enhanced distinctiveness** of the earlier mark is carried out only in respect of the goods or services protected by the sign for which enhanced distinctiveness is claimed and that have been found to be identical or similar to the contested goods and services.

Furthermore, it is the perception of the relevant public for these goods and services that is of relevance (e.g. whether a specialist public is involved or not).

## 2.2 Examination of inherent distinctiveness of the earlier mark

### 2.2.1 General principles

The first step in examining the distinctiveness of the earlier mark is to examine its inherent distinctiveness. The same rules and principles apply as those for the examination of distinctiveness of components, in terms of the relevant public and its linguistic and cultural background, relevant territory, relevant goods and services, etc. (see the Guidelines, [Part C, Opposition, Section 2, Double identity and likelihood of confusion, Chapter 4, Comparison of signs, paragraph 3.2](#)).

At the stage of determining the distinctiveness of the earlier mark as a whole, the distinctiveness of its various components (or its only component) has already been established in the section on comparison of signs. In principle, if an earlier mark contains a component that has a normal degree of distinctiveness, then the inherent distinctiveness of such an earlier mark as a whole is also normal, regardless of the possible presence of other non-distinctive or weak components. If the most distinctive

component of the earlier mark is distinctive only to a low degree, then in principle the overall inherent distinctiveness of that mark will be no more than low.

As mentioned above, earlier registered trade marks are presumed to have **at least a minimum degree** of inherent distinctiveness (24/05/2012, [C-196/11 P](#), F1-Live, EU:C:2012:314), even where persuasive evidence is submitted to challenge this presumption. If the EUTM applicant proves that it has started a cancellation action against the earlier registered mark, then it might be necessary to suspend the opposition proceedings pending the outcome of the said action.

The outcome of the examination of inherent distinctiveness of the earlier mark as a whole will be one of the following.

- The earlier mark has **less than normal degree of distinctiveness** because, as a whole, it is allusive (in a way that materially affects distinctiveness) or laudatory of the characteristics of identical or similar goods or services (or because it is otherwise weak). As set out above, the Office will not conclude that an earlier mark as a whole is descriptive and/or non-distinctive.
- The earlier mark has a **normal degree of distinctiveness** because, as a whole, it is not descriptive, allusive (in a way that materially affects distinctiveness) or laudatory (or is not otherwise weak) in relation to identical or similar goods or services.

It is Office practice, when an earlier mark is not descriptive (or is not otherwise non-distinctive), to consider it as having no more than a normal degree of inherent distinctiveness. In principle, when an earlier word mark has no particular meaning with regard to the relevant goods or services, it has a normal degree of inherent distinctiveness (23/02/2022, [T-198/21](#), Code-x / Cody's (fig.) et al., EU:T:2022:83, § 56; 30/06/2021, [T-501/20](#), Panta rhei / Panta rhei, EU:T:2021:402, § 59). In this regard, the absence of any conceptual link between the mark and the relevant goods or services does not automatically confer on that mark a high degree of inherent distinctiveness capable of providing it broader protection (as expressly stated in 16/05/2013, [C-379/12 P](#), H. EICH / SILVIAN HEACH (fig.), EU:C:2013:317, § 71 and, recently, in the same line, in 19/06/2019, [T-28/18](#), AC MILAN (fig.) / AC et al., EU:T:2019:436, § 54). However, as indicated above, the degree of distinctiveness can be further enhanced if appropriate evidence is submitted showing the earlier mark has acquired a higher degree of distinctiveness through use.

### 2.2.2 Impact of the low distinctiveness of the earlier mark

As explained in [paragraph 2.1.1](#) above, the Office, following the case-law of the Court of Justice, attributes at least a minimum degree of distinctiveness to the earlier mark.

A finding that a trade mark has a low or even very low (minimal) degree of distinctiveness may have a different impact on the likelihood of confusion. In general, this finding is an argument against a likelihood of confusion. It must however be balanced with the other factors, like the degree of similarity of the signs and the goods or services, as well as the degree of attention and sophistication of the relevant public.

The Court has emphasised on several occasions that a finding of a low distinctive character for the earlier trade mark does not prevent a finding of a likelihood of confusion. Although the distinctive character of the earlier mark must be taken into account when assessing the likelihood of confusion, it is only one factor among others involved in that assessment. Thus, even in a case involving an earlier mark of weak distinctive character, there may be a likelihood of confusion on account, in particular, of a high degree of similarity between the signs and between the goods or services covered (13/12/2007, [T-134/06](#), Pagesjaunes.com, EU:T:2007:387, § 70).

The **likelihood of confusion was affirmed** for similar and identical goods, when the trade marks differed only in stylisation or non-distinctive figurative elements and showed therefore a high degree of similarity.

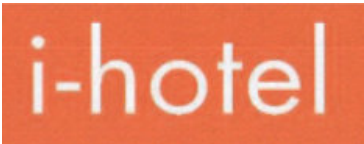
Earlier mark	Contested sign	Case No
	iHotel	13/06/2012, <a href="#">T-277/11</a> , EU:T:2012:295
<p>G&amp;S: Class 43 and others related to travel and hotel services</p> <p><i>Territory:</i> EU</p> <p><i>Assessment:</i> the trade marks are visually highly similar; there is phonetic and conceptual identity.</p>		

Earlier mark	Contested sign	Case No
SHE		15/10/2015, <a href="#">T-642/13</a> , EU:T:2015:781
<p>G&amp;S: Class 25</p> <p><i>Territory:</i> Germany</p> <p><i>Assessment:</i> the trade marks are visually and conceptually similar; there is phonetic identity.</p> <p>The finding of the likelihood of confusion is not called into question by the argument that the earlier word mark is purely descriptive and thus has a low distinctive character.</p> <p>The fact that the mark at issue consists of the same word sign as the earlier word mark and differs from it solely by a figurative element without particular meaning could be perceived as a particular configuration of the earlier word mark (paras 73, 77).</p>		

However, **the likelihood of confusion was excluded** even for identical goods in cases where the degree of similarity between the marks was low due to differences resulting from an additional fully distinctive element:

Earlier mark	Contested sign	Case No
POST	TPG POST	13/05/2015, <a href="#">T-102/14</a> , EU:T:2015:279
<p>G&amp;S: Class 39 and others related to postal services</p> <p><i>Territory:</i> Germany, EU</p> <p><i>Assessment:</i> the earlier mark has limited distinctiveness. The differences between the marks due to the addition of the distinctive element 'TPG' will be perceived visually, phonetically and conceptually (paras 61, 68).</p>		

Earlier mark	Contested sign	Case No
F1	F1H2O	21/05/2005, <a href="#">T-55/13</a> , EU:T:2015:309
<p>G&amp;S:Class 9, 25, 38, 41</p> <p><i>Territory:</i> IT, UK and others</p> <p><i>Assessment:</i> the visual and phonetic similarity is low, the signs are conceptually dissimilar. The element 'F1' is indeed likely to create a link in the mind of the relevant public between those goods and services and the field of motor racing. The distinctiveness of the earlier word marks does not help confer on those marks, or on the element of the mark applied for composed of the alphanumeric combination 'F1', a dominant character or independent distinctive character, inasmuch as the mark applied for is not broken down by the relevant public, but would be perceived by that public in its entirety (paras 45, 50).</p>		

### 2.2.3 Specific themes

#### 2.2.3.1 One-letter signs, numerals and short signs

The Court, in its judgment of 09/09/2010, [C-265/09 P](#), α, EU:C:2010:508, held that the distinctiveness of single-letter trade marks must be assessed according to an examination based on the facts, focusing on the goods or services concerned and the **same criteria that apply to other word marks** (paras 33-39). Although that judgment deals with absolute grounds, the Office considers that the principle established by the Court (i.e. that the application of the criterion of distinctiveness must be the same for all marks) also applies in *inter partes* cases when it comes to determining the distinctiveness of single-letter trade marks.

The Court, while acknowledging that it may prove more difficult to establish distinctiveness for marks consisting of a single letter than for other word marks, held that these circumstances do not justify laying down specific criteria supplementing or derogating from application of the criterion of distinctiveness as interpreted in the case-law.

The Office considers the ruling to mean that, when establishing the distinctiveness of an earlier mark, it is not correct to rely on assumptions such as a priori statements that consumers are not in the habit of perceiving single letters as trade marks or on generic arguments such as that relating to the availability of signs, given the limited number of letters.

The General Court has since stated in a number of cases that a trade mark containing a **single letter** or a single numeral may indeed be inherently distinctive (08/05/2012, [T-101/11](#), G, EU:T:2012:223, § 50; 06/10/2011, [T-176/10](#), Seven for all mankind, EU:T:2011:577, § 36; 05/11/2013, [T-378/12](#), X, EU:T:2013:574, § 37-51).

In its judgment of 10/05/2011, [T-187/10](#), G, EU:T:2011:202, the General Court dismissed the applicant's argument that single letters are generally per se devoid of distinctive character and that therefore only their graphic representation would be protected (paras 38, 49).

Consequently, whilst registered **earlier trade marks consisting of a single letter (or numeral)** represented in **standard characters** enjoy a presumption of validity, ultimately their degree of inherent distinctiveness will have to be assessed with reference to the goods/services concerned.

If the corresponding claim is made, account should be taken of evidence submitted by the opponent that demonstrates that its registered trade mark consisting of a single letter has acquired **enhanced distinctiveness**. This circumstance could lend the earlier trade mark a broader scope of protection.

The above considerations apply both to single-letter/numeral trade marks represented in standard characters (i.e. word marks) and to stylised single-letter/numeral trade marks.

Where the opponent has successfully proven that its single-letter trade mark has acquired enhanced distinctiveness through intensive use, the impact thereof on the final outcome has to be carefully assessed. Firstly, enhanced distinctiveness on the part of the earlier single-letter trade mark cannot justify a finding of likelihood of confusion if the overall visual impression conveyed by the signs is so different as to safely set them apart. Secondly, if the evidence shows use of a single-letter trade mark that is stylised or accompanied by additional figurative elements, the benefit of the resulting broader scope of protection accrues to the form in which it was used and not to the single letter as such or any other stylised variation.

Furthermore, in accordance with the  $\alpha$  judgment, as regards **short signs**, unless a letter combination, as such, is intrinsically non-distinctive for the goods and services (e.g. 'S' or 'XL' for goods in Class 25), these signs are not necessarily distinctive only to a low degree. The same rules apply to numerals.

### 2.2.3.2 Collective marks

Where the mark on which the opposition is based is a collective mark, its inherent distinctiveness is to be assessed in the usual way. The mark may have a low or even very low degree of inherent distinctiveness when it refers to the nature or other characteristics of the goods concerned. The fact that the mark is a collective mark does not imply that its scope of protection is broader (13/06/2012, [T-534/10](#), Hellim, EU:T:2012:292, § 49-52; 05/12/2012, [T-143/11](#), F.F.R., EU:T:2012:645, § 61).

Even where the earlier mark is a collective mark that contains a geographically descriptive element and is registered pursuant to [Article 74\(2\) EUTMR](#), its distinctiveness is to be assessed in the usual way. The geographically descriptive elements in such collective marks will be considered to be devoid of distinctive character. This is because the distinctiveness of such marks must stem from the addition of other elements enabling the consumer to distinguish the goods or services of the members of the proprietor association from those of other undertakings (05/03/2020, [C-766/18 P](#), BBQLOUMI (fig.) / HALLOUMI, EU:C:2020:170, § 72-73). If the earlier mark consists only of a geographically descriptive element, its distinctiveness should be considered low (24/05/2012, [C-196/11 P](#), F1-Live, EU:C:2012:314, § 44).

## 2.3 Examination of enhanced distinctiveness

**After** the obligatory **examination of inherent distinctiveness**, the second step is to check — provided the opponent has made the corresponding claim <sup>(65)</sup> — whether the earlier mark has acquired enhanced distinctiveness at the time of filing (or priority date) of the contested EUTM application as a consequence of the use that the opponent has made of it.

The distinctiveness of the earlier mark always has to be taken into account when deciding on the likelihood of confusion. The more distinctive the earlier trade mark, the greater will be the likelihood of confusion (11/11/1997, [C-251/95](#), Sabèl, EU:C:1997:528, § 24). Therefore, marks with a highly distinctive character, enjoy broader protection than marks with a less distinctive character (29/09/1998, [C-39/97](#), Canon, EU:C:1998:442, § 18).

In practice, this means that the fact that an earlier trade mark enjoys enhanced distinctive character or reputation is an argument in favour of finding a likelihood of confusion.

Enhanced distinctiveness of an individual mark means that the relevant public recognises the mark as having an enhanced ability or a high capacity to identify the goods or services for which it is registered as coming from a particular undertaking. Mere knowledge or recognition of the mark by the relevant public as, for instance, a certification mark, is not sufficient. The enhanced recognition of a mark must be related

<sup>65</sup> See the Guidelines, [Part C, Opposition, Section 1, Opposition Proceedings, paragraph 4.2](#).

to its essential function, which is, in the case of individual marks, that of indicating commercial origin. Enhanced distinctiveness of the mark is the result of its use in accordance with its essential function (07/06/2018, [T-807/16](#), N & NF TRADING / NF ENVIRONNEMENT (fig.) et al., EU:T:2018:337).

Use in accordance with the mark's essential function may enhance the distinctiveness of marks with little or no inherent distinctiveness or of those that are inherently distinctive.

Earlier mark	Contested sign	Case No
CRISTAL		17/11/2003, <a href="#">R 37/2000-2</a>
<p>G&amp;S: Class 33</p> <p>Territory: France</p> <p>Assessment: (earlier mark 'CRISTAL') 'As regards the claim that "Cristal" is a descriptive word for the goods at issue (sparkling wines with crystalline character), the Board cannot accept it. On the one hand, it is an evocative indication which suggests the crystalline character of wines, but which in no way describes the product. On the other hand, [the Board] considers that a highly distinctive character of the mark CRISTAL on the French market had been shown.' (para. 31)</p>		

The Court has given some guidance in respect of the evaluation of distinctiveness acquired through use of the earlier mark and provided a non-exhaustive list of factors.

In making that assessment, account should be taken, in particular, of the inherent characteristics of the mark, including the fact that it does or does not contain an element descriptive of the goods or services for which it has been registered; the market share held by the mark; how intensive, geographically widespread and long-standing use of the mark has been; the amount invested by the undertaking in promoting the mark; the proportion of the relevant section of the public which, because of the mark, identifies the goods or services as originating from a particular undertaking; and statements from chambers of commerce and industry or other trade and professional associations.

(22/06/1999, [C-342/97](#), Lloyd Schuhfabrik, EU:C:1999:323, § 23)

The evidence of enhanced distinctiveness acquired through use must refer to both (i) the relevant geographical area and (ii) the relevant goods and services. The opponent may claim enhanced distinctive character of the earlier mark for only part of the registered goods and services. According to the evidence submitted, the Office must establish precisely for which goods and services distinctiveness has been acquired. The nature, factors, evidence and assessment of enhanced distinctiveness are the same as for reputation. For further details on the evidence required and its



assessment see the Guidelines, [Part C, Opposition, Section 5, Trade Marks with Reputation \(Article 8\(5\) EUTMR\)](#).

However, a finding of reputation requires that a certain threshold of recognition be met whilst, as set out above, the threshold for a finding of enhanced distinctiveness may be lower.

Enhanced distinctiveness is anything above inherent distinctiveness.

Earlier mark	Contested sign	Case No
EL COTO	<p style="text-align: center;"><i>Coto D'Arcis</i></p> 	12/03/2008, <a href="#">T-332/04</a> , EU:T:2008:69
<p>G&amp;S: Classes 33, 35, 39</p> <p><i>Territory:</i> EU</p> <p><i>Assessment:</i> enhanced distinctiveness of the trade mark 'EL COTO': 'The Board of Appeal took into account the market knowledge of the earlier mark 'EL COTO' and made a proper assessment of the relevant case-law principles to conclude that the earlier mark 'EL COTO' has a highly distinctive character; it based its finding on the following facts: the certificate issued by the Secretary General of the Consejo Regulador de la Denominación de Origen Calificada 'Rioja', which certifies that the owner markets its wines, among others, under the brand names 'El Coto' and 'Coto de Imaz' since 1977 and that these marks 'enjoy a significant well-known character' in Spain, various decisions of the Spanish Patent and Trade Mark Office acknowledging that the mark 'EL COTO' is well known in Spain, a document on sales evolution, indicating that they had sold under the mark 'El Coto' 339 852, 379 847, 435 857 and 464 080 boxes of twelve bottles of wine in 1995, 1996, 1997 and 1998, respectively' (para. 50).</p>		

Importantly, acquisition of enhanced distinctive character by a mark may be a result of its use as part of another registered trade mark (07/07/2005, [C-353/03](#), *Have a break*, EU:C:2005:432, § 30-32; 07/09/2006, [T-168/04](#), *Aire limpio*, EU:T:2006:245, § 74).

The outcome of the examination of enhanced distinctiveness will be one of the following.

- Where there is no evidence of enhanced distinctiveness as regards the relevant goods and services or the territory, or the evidence is insufficient, the degree of distinctiveness of the earlier mark will be its inherent distinctiveness (less than normal or normal).
- Where there is evidence of enhanced distinctiveness as regards all or some of the relevant goods and services and the territory, and the evidence is sufficient:
  - if the earlier mark has less than normal inherent distinctiveness, the mark/component may have acquired a normal or even a high degree of distinctiveness, depending on the evidence submitted <sup>66</sup>; or



- if the earlier trade mark has normal inherent distinctiveness, it may have acquired high distinctiveness.

It must be recalled that although a mark as a whole may have acquired enhanced distinctiveness, there may be descriptive elements that will have less than normal or no distinctiveness. For example, the enhanced distinctiveness of the mark 'Coca Cola' as a whole does not alter the fact that the element 'Cola' remains entirely descriptive for certain products.

---

<sup>66</sup> For further details on the evidence required and its assessment see the Guidelines, [Part C, Opposition, Section 5, Trade Marks with Reputation \(Article 8\(5\) EUTMR\)](#).

***GUIDELINES FOR EXAMINATION OF  
EUROPEAN UNION TRADE MARKS***

***EUROPEAN UNION  
INTELLECTUAL PROPERTY OFFICE  
(EUIPO)***

***Part C***

***Opposition***

***Section 2***

***Double identity and likelihood of confusion***

***Chapter 6***

***Other factors***

## Table of Contents

<b>1 Introduction.....</b>	<b>1117</b>
<b>2 Family of Marks/Series of Marks.....</b>	<b>1117</b>
<b>3 Coexistence of Conflicting Marks on the Market in the Same Territory...</b>	<b>1121</b>
3.1 Coexistence between the marks involved in the opposition.....	1121
<b>4 Incidences of Actual Confusion.....</b>	<b>1123</b>
<b>5 Prior Decisions by EU or National Authorities Involving Conflicts     Between the Same (or Similar) Trade Marks.....</b>	<b>1124</b>
5.1 Prior Office decisions.....	1124
5.2 Prior national decisions and judgments.....	1125
<b>6 Irrelevant Arguments for Assessing Likelihood of Confusion.....</b>	<b>1127</b>
6.1 Specific marketing strategies.....	1127
6.2 Reputation of EUTM application.....	1127

## 1 Introduction

The Office normally examines the most salient and habitually relevant factors relating to likelihood of confusion under separate headings before the chapter on global assessment. These factors have been treated in the preceding chapters of these Guidelines.

However, the global assessment also takes into account **other factors, based on arguments and evidence submitted by the parties**, which are relevant for deciding on likelihood of confusion. This chapter deals with the frequent arguments/claims raised by the parties.

## 2 Family of Marks/Series of Marks

When an opposition to an EUTM application is based on several earlier marks and those marks display characteristics that give grounds for regarding them as forming part of a single ‘series’ or ‘family’, a likelihood of confusion may be created by the possibility of association between the contested trade mark and the earlier marks forming part of the series. The Courts have given clear indications on the two cumulative conditions that have to be satisfied (23/02/2006, [T-194/03](#), Bainbridge, EU:T:2006:65, § 123-127, confirmed 13/09/2007, [C-234/06 P](#), Bainbridge, EU:C:2007:514, § 63).

- Firstly, the proprietor of a series of earlier marks must submit **proof of use** of all the marks belonging to the series or, at the very least, of a number of marks capable of constituting a ‘series’ (i.e. at least three).
- Secondly, the trade mark applied for must **not only be similar** to the marks belonging to the series, but must also display characteristics capable of **associating** it with the series. Association must lead the public to believe that the contested trade mark is also part of the series, that is to say, that the goods and services could originate from the same or connected undertakings. This may not be the case where, for example, the element common to the earlier series of marks is used in the contested trade mark, either in a different position from that in which it usually appears in the marks belonging to the series, or with a different semantic content.

The argument that there is a ‘family of marks’ must be claimed before the expiry of the **time limit set for substantiating the opposition**. The opponent must prove within the same time limit that it has used the marks forming the alleged family in the marketplace to such an extent that the relevant public has become familiar with this family of marks as designating the goods and/or services of a particular undertaking.

A positive finding that the opponent has a family of marks entails **the use of at least three marks**, the minimum threshold for such an argument to be taken into due consideration. Proof of use relating to only two trade marks cannot substantiate the existence of a series of marks.

Normally, the trade marks constituting a ‘family’ and used as such are all registered marks. However, it cannot be precluded that the ‘family of marks’ doctrine may also include **non-registered trade marks**.

When the opponent has proven the existence of a family of marks, it would be wrong to compare the contested application individually with each of the earlier marks making up the family. Rather, the assessment of similarity **should be conducted to make a comparison between the contested mark and the family taken as a whole**, in order to establish if the contested sign displays those characteristics that are likely to trigger the association with the opponent’s family of marks in consumers’ minds. In fact, an individual comparison between the conflicting signs might even lead to a finding that the signs are not sufficiently similar to lead to a likelihood of confusion, whereas the association of the contested sign with the earlier family of marks might be the decisive factor that tips the balance to a finding of likelihood of confusion.

An assumption of a family of marks on the part of the public requires that the **common denominator of the contested application and the earlier family of marks must have a distinctive character**, either per se or acquired through use, to allow a direct association between all of these signs. Likewise, there will be no assumption of a family of marks where the further components of the earlier signs have a greater impact in the overall impression of those signs.

Earlier signs	Contested sign	Case No
Ophtal, Crom-Ophtal, Visc-Ophtal, Pan-Ophtal	ALERGOFTAL	06/06/2002, <a href="#">R 838/2001-1</a>
<p>G&amp;S: Class 5</p> <p><i>Territory:</i> Germany</p> <p><i>Assessment:</i> the Board held that the differences between the signs were such as to exclude the likelihood that the contested mark would be perceived as belonging to the opponent’s family of marks (assuming the existence of this had been established). In particular, the Board considered that, whereas the claimed ‘series’ depended upon the presence in every case of the suffix ‘-ophtal’ (and not ‘oftal’) preceded by a hyphen, the contested sign did not contain exactly the same suffix nor reflect exactly the same principles of construction. When ‘ophtal’ is combined with ‘Pan-’, ‘Crom-’ and ‘Visc-’, these partly disjointed prefixes become of greater distinctive value, affecting quite significantly the overall impression made by each of the marks as a whole, and in each case providing initial elements quite clearly different from the first half — ‘Alerg’ — of the mark applied for. The German consumer, upon seeing ‘Alergoftal’ would not think of dividing it into two elements, as opposed to being invited to do so when encountering marks made up of two elements separated by a hyphen (paras 14, 18).</p>		
Earlier signs	Contested sign	Case No
TIM OPHTAL, SIC OPHTAL, LAC OPHTAL etc.	OFTAL CUSI	14/07/2011, <a href="#">T-160/09</a>

G&S: Class 5

*Territory:* EU

*Assessment:* the element 'Ophtal', which denotes ophthalmologic preparations, is a weak element in the family of marks. The elements TIM, SIC and LAC are the distinctive elements (paras 92-93).



The finding that a particular mark forms part of a family of marks requires that the **common component of the signs is identical or very similar**. The signs must contain the same distinctive element, and this element must play an independent role in the sign as a whole. Minor graphical differences in the common component may not exclude an assumption of a series of marks, when these differences may be understood by the public to be a modern presentation of the same product line. In contrast, letters that are different from or additional to the common component generally do not allow an assumption of a family of marks.

Normally, the **common element that characterises the family appears in the same position within the marks**. Therefore, the same (or very similar) element appearing in the same position in the contested sign will be a strong indicator that the later mark could be associated with the opponent's family of marks. However, the common element appearing in a different position in the contested sign weighs heavily against such an association being established in the consumers' minds. For example, the contested sign ISENBECK is not likely to be associated with a family of BECK- marks where the element BECK is at the beginning of the signs making up the family.

Earlier signs	Contested sign	Case No
UNIZINS, UNIFONDS and UNIRAK	UNIWEB	16/06/2011, <a href="#">C-317/10 P</a>
<p>G&amp;S: Class 36 (<i>financial services</i>)</p> <p><i>Territory:</i> Germany</p> <p><i>Assessment:</i> in this judgment the Court annulled a decision of the GC since it had not duly assessed the structure of the marks to be compared, <b>nor the influence of the position of their common element</b> on the perception of the relevant public (para. 57).</p>		

#### Examples where the Boards considered that a family of marks had been established

Earlier signs	Contested sign	Case No
---------------	----------------	---------

UniSECTOR    	uni-gateway	05/03/2009, <a href="#">R 31/2007-1</a>
<p><i>G&amp;S: Class 36 (financial services)</i></p> <p><i>Territory: Germany</i></p> <p><i>Assessment:</i> the Board considered that the opponent had in fact submitted sufficient evidence, by submitting, in particular, references from the relevant specialist press, such as FINANZtest, and by referring to its considerable 17.6 % market share of 'Uni' investment funds amongst German fund management companies, to show that it uses the prefix 'UNI' for a number of well-known investment funds. There is a likelihood of confusion from the point of view of the family of trade marks since the relevant trade circles would include in the series the trade mark applied for, since it is constructed in accordance with a comparable principle (paras 43-44).</p>		
<b>Earlier signs</b>	<b>Contested sign</b>	<b>Case No</b>
UNIFIX, BRICOFIX, MULTIFIX, CONSTRUFIX, TRABAFIX, etc.	ZENTRIFIX	11/09/2008, <a href="#">R 1514/2007-1</a>
<p><i>G&amp;S: Classes 1, 17 and 19 (adhesives)</i></p> <p><i>Territory: Spain</i></p> <p><i>Assessment:</i> the Board considered that the opponent had proven the existence of a family of marks. Firstly, the Board discarded that the common element 'FIX' would be non-distinctive, given that it is not a Spanish word and even its Spanish meaning 'fijar' is not one that spontaneously comes to mind to average Spanish consumers in the context of glues and adhesives, since verbs like 'pegar', 'encolar' or 'adherir' are used more regularly in this context. Secondly, the opponent duly proved that all the marks forming the family are being used. Invoices and promotional literature duly show that goods bearing these marks are available to consumers on the market. Consumers, therefore, are aware that there is a family of marks. Thirdly, ZENTRIFIX has characteristics that replicate those of the trade marks in the family. The FIX element is placed at the end; the element that precedes it alludes to something that has some relevance to glues; the two elements are juxtaposed without any punctuation signs, dashes or physical separation; the typeface used for the two elements is the same (paras 43-44).</p>		
<b>Earlier signs</b>	<b>Contested sign</b>	<b>Case No</b>
CITIBANK, CITIGOLD, CITICORP, CITIBOND, CITICARD, CITIEQUITY, etc.	CITIGATE	30/04/2009, <a href="#">R 821/2005-1</a>  (confirmed 26/09/2012, <a href="#">T-301/09</a> , EU:T:2012:473)

G&S: Classes 9, 16 (potentially finance-related goods)

*Territory:* EU

*Assessment:* the Board considered that the evidence — consisting in particular of extracts from the opponents' websites, annual reports, press advertisements and so forth — is littered with references to the trade marks CITICORP, CITIGROUP, CITICARD, CITIGOLD, CITIEQUITY. The evidence demonstrates that CITIBANK is in the nature of a 'house mark' or basic brand and that the opponents have developed a whole series of sub-brands based on the CITI concept. The contested mark CITIGATE is the sort of mark that the opponents might add to their portfolio of CITI marks, in particular if they wished to offer a new service to customers and place the emphasis on the idea of access (paras 23-24).

### **3 Coexistence of Conflicting Marks on the Market in the Same Territory**

The EUTM applicant may claim that the conflicting trade marks coexist in the relevant territory. Usually the coexistence argument comes up when the applicant owns a national trade mark corresponding to the EUTM application in the territory where the opposing trade mark is protected. The applicant may also refer to coexistence with a trade mark owned by a third party.

Therefore, two different situations, both referred to as 'coexistence' by the parties, should be distinguished:

- coexistence between the two marks involved in the opposition can be persuasive of the absence of a likelihood of confusion in the relevant public's perception (see below);
- where many similar marks (other than the two marks involved in the opposition) are used by competitors, the coexistence may affect the scope of protection of the earlier right. See the Guidelines, [Part C, Opposition, Section 2, Double Identity and Likelihood of Confusion, Chapter 5, Distinctiveness of the Earlier Mark](#).

#### **3.1 Coexistence between the marks involved in the opposition**

In opposition proceedings, it is most commonly argued by the EUTM applicant that the conflicting marks coexist on a national level and that the coexistence is tolerated by the opponent. Occasionally, it is argued that coexistence is accepted by the parties in a coexistence agreement.

The possibility cannot be ruled out that the coexistence of two marks on a particular market might, together with other elements, contribute to diminishing the likelihood of confusion between those marks on the part of the relevant public (03/09/2009, [C-498/07 P](#), La Española, EU:C:2009:503, § 82). In certain cases, the coexistence of earlier marks in the market could reduce the likelihood of confusion that the Office finds



between two conflicting marks (11/05/2005, [T-31/03](#), Grupo Sada, EU:T:2005:169, § 86).

However, the indicative value of coexistence should be treated with **caution**. There might be different reasons why the two signs coexist on a national level, for example, a different legal or factual situation in the past or prior rights agreements between the parties involved.

Therefore, whilst the impact of coexistence on the finding of likelihood of confusion is accepted in theory, the conditions for this coexistence to be persuasive of the absence of a risk of confusion are, in practice, very difficult to establish and seldom prevail.

For the EUTM applicant to prove that the coexistence was based upon the absence of any likelihood of confusion on the part of the relevant public, certain conditions must be met.

- **Comparable situation.** The earlier ('coexisting') marks and the marks at issue are **identical** to those involved in the opposition before the Office (11/05/2005, [T-31/03](#), Grupo Sada, EU:T:2005:169, § 86; 18/09/2012, [T-460/11](#), Bürger, EU:T:2012:432, § 60-61) and cover the same goods or services as those in conflict (30/03/2010, [R 1021/2009-1](#), ECLIPSE / ECLIPSE (fig.), § 14).
- The coexistence concerns the relevant **countries** in the case (e.g. alleged **coexistence in Denmark is irrelevant when the opposition is based on a Spanish** trade mark; 13/07/2005, [T-40/03](#), Julián Murúa Entrena, EU:T:2005:285, § 85). If the earlier trade mark is an EUTM, the EUTM applicant must show coexistence in the entire EU.
- Only coexistence in the **marketplace** can be taken into account. The mere fact that both trade marks exist in the national register (formal coexistence) is insufficient. The EUTM applicant has to prove that the trade marks were **actually used** (13/04/2010, [R 1094/2009-2](#), BUSINESS ROYALS (fig.) / ROYALS (fig.), § 34). Coexistence should be understood as 'co-use' of concurrent and supposedly conflicting marks (08/01/2002, [R 360/2000-4](#), NO LIMITS / LIMMIT, § 13; 05/09/2002, [R 1/2002-3](#), CHEE.TOS / Chitos, § 22).
- The **period of coexistence** must be taken into consideration: in the judgment of 01/03/2005, [T-185/03](#), Enzo Fusco, EU:T:2005:73, the alleged coexistence of only 4 months was considered obviously too short. Moreover, the coexistence of the trade marks has to relate to a period close to the filing date of the EUTM application (12/05/2010, [R 607/2009-1](#), ELSA ZANELLA (fig.) / ZANELLA et al., § 39).
- The absence of a likelihood of confusion may be only inferred from the '**peaceful**' nature of the coexistence of the marks at issue on the market concerned (03/09/2009, [C-498/07 P](#), La Española, EU:C:2009:503, § 82; 08/12/2005, [T-29/04](#), Cristal Castellblanch, EU:T:2005:438, § 74; 24/11/2005, [T-346/04](#), Arthur et Félicie, EU:T:2005:420, § 64). This is not the case when the conflict has been an issue before the national courts or administrative bodies (infringement cases, oppositions or applications for annulment of a trade mark).
- Moreover, the peaceful coexistence of the trade marks in the relevant national market does not outweigh the likelihood of confusion if it is based on prior rights agreements between the parties, including agreements settling disputes before

national courts, since these agreements, even if based on the assessment of the legal situation made by the parties, may have purely economic or strategic reasons.

However, exceptional situations are possible. In its preliminary ruling of 22/09/2011, [C-482/09](#), Budweiser, EU:C:2011:605, the Court of Justice ruled that two identical trade marks designating identical goods can coexist on the market to the extent that there has been a long period of **honest concurrent use** of those trade marks and that use neither has nor is liable to have an adverse effect on the essential function of the trade mark, which is to guarantee consumers the origin of the goods and services.

As regards **coexistence agreements** between the parties, when assessing likelihood of confusion, the Office's policy is that these agreements may be taken into account like any other relevant factor, but they are **in no way binding on the Office**. This is particularly true when the application of the relevant provisions of the EUTMR and the established case-law lead to a conclusion that is not in accordance with the content of the agreement.

If an agreement is disputed before national instances or there are pending court proceedings and the Office estimates that the outcome could be relevant for the case at issue, it may decide to suspend the proceedings.

In addition, as a general rule, nothing precludes the opponent from filing an opposition against an EUTM application, whether or not it previously opposed other (national) marks of the applicant. This cannot be considered as 'contradictory behaviour' and interpreted to the opponent's disadvantage, especially since in opposition proceedings, unlike invalidity proceedings, the defence of 'acquiescence' is not available (the rules for opposition proceedings do not contain an equivalent to [Article 61 EUTMR](#), according to which an EUTM proprietor may invoke as a defence the fact that the applicant for invalidity has acquiesced to the use of the EUTM for more than 5 years).

## 4 Incidences of Actual Confusion

Likelihood of confusion means a **probability** of confusion on the part of the relevant consumer and does not require **actual** confusion. As expressly confirmed by the Court: '... it is not necessary to establish the existence of actual confusion, but the existence of a likelihood of confusion' (24/11/2005, [T-346/04](#), Arthur et Félicie, EU:T:2005:420, § 69).

In the global assessment of likelihood of confusion, all relevant factors have to be taken into consideration. Evidence of actual confusion is a factor that may weigh in favour of likelihood of confusion; its indicative value should not, however, be overestimated for the following reasons:

- in everyday life there are always people who confuse and misconstrue everything, and others who are extremely observant and very familiar with every trade mark. Therefore, there is no legal value in highlighting the existence of these people since it could lead to subjective results;

- insofar as the targeted consumer's perception is concerned, the assessment is normative. The average consumer is assumed to be 'reasonably well informed and reasonably observant and circumspect', even though in purely factual terms some consumers are extremely observant and well informed, whilst others are careless and credulous (10/07/2007, [R 40/2006-4](#), SDZ DIRECT WORLD / SAZ, § 32).

Therefore, incidences of actual confusion can influence the finding of likelihood of confusion only if it is proven that these incidences usually accompany the existence of the conflicting trade marks in the market in the typical situation in trade involving the goods and/or services concerned.

To properly weigh evidence on the number of occasions when actual confusion has arisen, the assessment must be made in the light of the number of opportunities for confusion. If the business transactions are voluminous but the instances of confusion are sparse, this evidence will have little weight in the assessment of likelihood of confusion.

Lack of actual confusion has been treated in the context of coexistence, in [paragraph 3](#) above.

## 5 Prior Decisions by EU or National Authorities Involving Conflicts Between the Same (or Similar) Trade Marks

### 5.1 Prior Office decisions

As regards previous decisions of the Office in conflicts between identical or similar trade marks, the General Court has stated that:

... it is settled case-law ... that the legality of the decisions of the [Office] is to be assessed purely by reference to [the EUTMR] and not the Office's practice in earlier decisions.

(30/06/2004, [T-281/02](#), Mehr für Ihr Geld, EU:T:2004:198, § 35.)

Accordingly, the Office is **not bound by its previous decisions**, since each case has to be dealt with separately and with regard to its particularities.

Notwithstanding the fact that previous decisions of the Office are not binding, their reasoning and outcome should still be **duly considered** when deciding upon the case in question. This was reinforced in the judgment of 10/03/2011, [C-51/10 P](#), 1000, EU:C:2011:139, § 73-75:

The Office is under a duty to exercise its powers in accordance with the general principles of European Union law, such as the principle of equal treatment and the principle of sound administration.

In the light of those two principles, the Office must, when examining an application for registration of a European Union trade mark, take into account the decisions already

taken in respect of similar applications and consider with special care whether it should decide in the same way or not ...

That said, the way in which the principles of equal treatment and sound administration are applied must be consistent with respect for legality.

The indicative value of the previous decisions will in principle be limited to cases that bear a sufficiently close resemblance to the case in question. However, according to [Article 95\(1\) EUTMR](#), in opposition proceedings the Office is restricted in the examination of the case to the facts, evidence and arguments submitted by the parties. For this reason, even in cases based on comparable facts and involving similar legal problems, the outcome may still vary due to the different submissions made by the parties and the evidence they present.

## 5.2 Prior national decisions and judgments

Decisions of national courts and of national offices in cases regarding conflicts between identical or similar trade marks on the national level **do not have a binding effect** on the Office. According to case-law, the European Union trade mark regime is an autonomous system with its own set of objectives and rules peculiar to it and applies independently of any national system. Accordingly, the registrability of a sign as a European Union trade mark is to be assessed on the basis of the relevant legislation alone (13/09/2010, [T-292/08](#), Often, EU:T:2010:399, § 84; 25/10/2006, [T-13/05](#), Oda, EU:T:2006:335, § 59).

Therefore, the decisions adopted in a Member State or in a state that is not a member of the European Union are not binding for the Office (24/03/2010, [T-363/08](#), Nollie, EU:T:2010:114, § 52).

Still, their reasoning and outcome should be **duly considered**, particularly when the decision has been taken in the Member State that is relevant to the proceedings. National courts have a thorough knowledge of the specific characteristics of their Member State, in particular as regards the marketplace reality in which goods and services are marketed and the customer perception of signs. This may, in particular cases, be relevant for the assessment made by the Office.

Earlier sign	Contested sign	Case No
MURUA		<a href="#">T-40/03</a>

G&S: Class 33

*Territory:* Spain

*Assessment:* the Court took into consideration the reasoning of a judgment of the national court as far as it explained the perception of family names on the part of the public in the relevant country: regarding the question whether the relevant public in Spain will generally pay greater attention to the surname ‘Murúa’ than to the surname ‘Entrena’ in the trade mark applied for, the Court considers that, while it is **not binding** on EU bodies, Spanish case-law can provide **a helpful source of guidance** (para. 69).

Earlier sign	Contested sign	Case No
	OFTEN	<a href="#">T-292/08</a>

G&S: Class 14

*Territory:* Spain

*Assessment:* the Court did not see the relevance of Spanish case-law, according to which an average member of the Spanish public has some knowledge of English for the assessment of the particular case:

In the present case, the applicant has not put forward any factual or legal consideration, deriving from the national case-law relied upon, which is capable of providing helpful guidance for determination of the case .... The mere finding that certain English words are known to the Spanish consumer, namely the words ‘master’, ‘easy’ and ‘food’, even if that is clear from the national case-law in question, cannot lead to the same conclusion as regards the word ‘often’ (para. 85).

Whilst it is, in principle, permissible to take into account decisions of national courts and authorities, these decisions should be examined **with all the required care and in a diligent manner** (15/07/2011, [T-108/08](#), Good Life, EU:T:2011:391, § 23). Usually the understanding of such a decision will require the submission of sufficient information, in particular about the facts on which the decision was based. Their indicative value will therefore be limited to the rare cases when the factual and legal background of the case was presented completely in the opposition proceedings and is conclusive, clear and not disputed by the parties.

The above guidelines are without prejudice to the effects of the judgments of EUTM courts dealing with counterclaims for revocation or for a declaration of invalidity of EUTMs.

## **6 Irrelevant Arguments for Assessing Likelihood of Confusion**

### **6.1 Specific marketing strategies**

The examination of the likelihood of confusion carried out by the Office is a prospective examination. In contrast to trade mark infringement situations — where the courts deal with specific circumstances in which the particular facts and the specific nature of use of the trade mark are crucial — the deliberations of the Office on likelihood of confusion are carried out in a more abstract manner.

For this reason, specific marketing strategies are not relevant. The Office must take the usual circumstances in which the goods covered by the marks are marketed as its benchmark, that is, those circumstances that are expected for the category of goods covered by the marks. The particular circumstances in which the goods covered by the marks are actually marketed have, as a matter of principle, no impact on the assessment of the likelihood of confusion because they may vary in time depending on the wishes of the proprietors of the trade marks (15/03/2007, [C-171/06 P](#), Quantum, EU:C:2007:171, § 59; 22/03/2012, [C-354/11 P](#), G, EU:C:2012:167, § 73; 21/06/2012, [T-276/09](#), Yakut, EU:T:2012:313, § 58).

For example, the fact that one party offers its everyday consumer goods (wines) for sale at a higher price than competitors is a purely subjective marketing factor that is, as such, irrelevant when assessing the likelihood of confusion (14/11/2007, [T-101/06](#), Castell del Remei Oda, EU:T:2007:340, § 52).

### **6.2 Reputation of EUTM application**

Applicants sometimes argue that there will be no likelihood of confusion with the earlier mark because the EUTM application has a reputation. This argument cannot prosper because the right to an EUTM begins on the date when the EUTM application is filed and not before, and it is from that date onwards that the EUTM has to be examined with regard to opposition proceedings. Therefore, when considering whether or not the EUTM falls under any of the relative grounds for refusal, events or facts that happened before the filing date of the EUTM are irrelevant because the opponent's rights, insofar as they predate the EUTM, are earlier than the applicant's EUTM.

***GUIDELINES FOR EXAMINATION OF  
EUROPEAN UNION TRADE MARKS***

***EUROPEAN UNION  
INTELLECTUAL PROPERTY OFFICE  
(EUIPO)***

***Part C***

***Opposition***

***Section 2***

***Double identity and likelihood of confusion***

***Chapter 7***

***Global assessment***

## Table of Contents

<b>1 Introduction.....</b>	<b>1130</b>
<b>2 Interdependence Principle.....</b>	<b>1130</b>
<b>3 Imperfect Recollection.....</b>	<b>1132</b>
<b>4 Impact of the Method of Purchase of Goods and Services.....</b>	<b>1132</b>
4.1 Visual similarity.....	1132
4.2 Aural similarity.....	1135
4.3 Conclusion.....	1136
<b>5 Impact of conceptual comparison on the likelihood of confusion.....</b>	<b>1136</b>
<b>6 Impact on Likelihood of Confusion of Components that are Non-Distinctive or Distinctive Only to a Low Degree.....</b>	<b>1138</b>
6.1 Common components with a low degree of distinctiveness.....	1138
6.2 Common components with no distinctiveness.....	1142
6.3 Distinctiveness of the earlier mark versus distinctiveness of the common component.....	1143
<b>7 Specific Cases.....</b>	<b>1144</b>
7.1 Short signs.....	1144
7.2 Names.....	1145
7.2.1 Personal names.....	1145
7.2.2 Business names in combination with other components.....	1151
7.3 Colour marks per se.....	1153
7.4 Earlier collective and certification marks.....	1154



## 1 Introduction

A likelihood of confusion (including a likelihood of association) exists if there is a risk that the public might believe that the goods or services in question, under the assumption that they bear the marks in question, come from the same undertaking or, as the case may be, from economically linked undertakings. If a significant part of the relevant public of the goods or services at issue may be confused as to the origin of the goods or services, this is sufficient. Therefore, there is no need to establish that all actual or potential consumers of the relevant goods or services are likely to be confused.

The Court has stated that likelihood of confusion must be appreciated globally, taking into account all the factors relevant to the circumstances of the case; this appreciation depends on numerous elements and, in particular, on the degree of recognition of the mark on the market, the association that the public might make between the two marks and the degree of similarity between the signs and the goods and services (11/11/1997, [C-251/95](#), Sabèl, EU:C:1997:528, § 22).

The Office normally examines the most salient and habitually relevant factors relating to likelihood of confusion and establishes their degrees:

1. similarity of the goods and services;
2. the relevant public and its degree of attention and sophistication;
3. similarity of the signs taking into account their distinctive and dominant elements;
4. the distinctiveness of the earlier mark.

In the last section of a decision containing the global assessment, those factors are weighed up. However, the global assessment can weigh up many other factors that are relevant to deciding on likelihood of confusion (see the Guidelines, [Part C, Opposition, Section 2, Double Identity and Likelihood of Confusion, Chapter 6, Other Factors](#)).

## 2 Interdependence Principle

The Court has set out the essential principle that evaluating likelihood of confusion implies some **interdependence between the relevant factors** and, in particular, between the previously established findings on the degree of similarity between the marks and that between the goods or services. Therefore, a lesser degree of similarity between goods and services may be offset by a greater degree of similarity between the marks and vice versa (29/09/1998, [C-39/97](#), Canon, EU:C:1998:442, § 17). This principle of interdependence is crucial to the analysis of likelihood of confusion.

The interdependence of those factors is expressly referred to in recital 11 in the Preamble to the EUTMR, according to which the concept of similarity is to be interpreted in relation to the likelihood of confusion, the assessment of which depends on numerous elements and, in particular, on the recognition of the mark on the market, the association that can be made with the used or registered sign, the degree of

similarity between the mark and the sign and that between the goods or services identified (10/09/2008, [T-325/06](#), Capio, EU:T:2008:338, § 72 and case-law cited).

The requirement for a global assessment and the principle of interdependence means that, where there is at least some degree of similarity between the signs and the relevant goods/services, there will be an assessment of likelihood of confusion involving an iterative process that weighs up all the relevant factors. This process takes place in the global assessment section.

In practice, this means that the **Office will weigh up**, inter alia, the degree of similarity between the goods and services and the degree of attention paid by the relevant public to those goods and services, the degree of similarity between the signs, and whether the impression produced in any aspect of the comparison (visual/aural/conceptual) is more important, and the distinctiveness of the earlier mark.

The outcome depends on the particularities of each case, but as a rule of thumb it can be said that, when there is an average degree of similarity between the signs and between the goods or services, the degree of attention of the relevant public is average and the earlier trade mark has a normal distinctiveness, there will be a likelihood of confusion. However, the lower the degree of one factor, the higher the degree of other factors must be in order to find a likelihood of confusion (bearing in mind that the likelihood of confusion is inversely affected by an increased degree of attention of the relevant public). Therefore, on the basis of an average degree of distinctiveness of the earlier mark and an average degree of attentiveness of the public, the finding of a likelihood of confusion may be justified when the signs are identical or highly similar, despite a low degree of similarity between the goods/services. However, such a finding is more difficult on the basis of a limited distinctiveness of the earlier mark and/or when the degree of attention of the public is higher than average. Furthermore, it is true that, by virtue of the principle of interdependence, a lesser degree of similarity between the goods or services covered may be offset by a greater degree of similarity between the marks, and vice versa. However, there is nothing to prevent a finding that, in view of the circumstances of a particular case, there is no likelihood of confusion, even where identical goods are involved and there is a certain degree of similarity between the marks at issue (26/03/2020, [T-343/19](#), Sonance / Conlance, EU:T:2020:124, § 63).

Moreover, the factors to be taken into account and their importance in the global assessment **will vary** according to the particular circumstances. For example, in clear-cut cases where the goods/services and the signs are highly similar or identical, the Office may find a likelihood of confusion without assessing all factors — such as enhanced distinctiveness, family of marks, etc.

Importantly, it is not possible to set out in the abstract whether one factor carries more weight than another, because these factors will have varying degrees of relative importance depending on the circumstances. For instance, the degree of visual similarity may weigh more heavily in connection with goods that are usually examined visually, whilst the degree of aural similarity may be more relevant to goods normally ordered orally (see [paragraph 4](#) below).

### 3 Imperfect Recollection

Although the average consumer of the category of products concerned is deemed to be reasonably well informed and reasonably observant and circumspect, account is taken of the fact that the average consumer only rarely has the chance to make a direct comparison between the different marks and must place trust in the imperfect picture of them that he or she has kept in mind. It should also be borne in mind that the average consumer's degree of attention is likely to vary according to the category of goods or services in question (22/06/1999, [C-342/97](#), Lloyd Schuhfabrik, EU:C:1999:323, § 26). Even consumers with a high degree of attention need to rely on their imperfect recollection of trade marks (21/11/2013, [T-443/12](#), ancotel, EU:T:2013:605, § 54).

### 4 Impact of the Method of Purchase of Goods and Services

The Court has stated that, when evaluating the importance attached to the degree of visual, aural and conceptual similarity between the signs, it is appropriate to take into account the category of goods or services in question and the way they are marketed (22/06/1999, [C-342/97](#), Lloyd Schuhfabrik, EU:C:1999:323, § 27). Those factors must be taken into account at the stage of the global assessment of the likelihood of confusion and not at the stage of assessing the similarity of the signs (04/03/2020, [C-328/18 P](#), Black Label by Equivalenza (fig.) / Labell (fig.) et al., EU:C:2020:156, § 70).





The category of goods and services involved may increase the importance of one of the different aspects of similarity between signs (visual, phonetic and conceptual) because of how goods and services are ordered and/or purchased. An aural or conceptual comparison between signs may be less important in the case of goods and services that are usually examined visually or may be tried on before being bought. In such cases, the visual impression of signs counts more in the assessment of likelihood of confusion.

However, it is important to emphasise that, as with all of the factors that are relevant to likelihood of confusion, the factors are interlinked and each set of circumstances must be examined on a case-by-case basis. This means that no general rule should be applied to broad categories of goods or services.

#### 4.1 Visual similarity

A good example of where visual similarity can play a greater — but not exclusive — role in the global assessment of the likelihood of confusion is *clothing*. Generally, in clothes shops, customers can either choose the clothes they wish to buy themselves or be assisted by the sales staff. Whilst oral communication in respect of the product and the trade mark is not excluded, the choice of the item of clothing is generally made

visually. Therefore, visual perception of the marks in question will generally take place prior to purchase. Accordingly, the visual aspect plays a greater role in the global assessment of the likelihood of confusion (14/10/2003, [T-292/01](#), Bass, EU:T:2003:264, § 55; 06/10/2004, [T-117/03-T-119/03](#) & [T-171/03](#), NL, EU:T:2004:293, § 50; 18/05/2011, [T-502/07](#), McKenzie, EU:T:2011:223, § 50; 24/01/2012, [T-593/10](#), B, EU:T:2012:25, § 47). These considerations played a role in finding no likelihood of confusion between the marks below for, inter alia, certain goods in Class 25.

Earlier sign	Contested sign	Case No
		<a href="#">T-502/07</a>
		<a href="#">T-593/10</a>

The same considerations were central to a finding of likelihood of confusion in the following cases also for, inter alia, certain goods in Class 25.

Earlier sign	Contested sign	Case No
		09/06/2009, <a href="#">R 1050/2008-4</a>
PETER STORM	PEERSTORM	08/07/2010, <a href="#">T-30/09</a> , EU:T:2010:298
		18/05/2011, <a href="#">T-376/09</a> , EU:T:2011:225

However, granting preferential consideration to the visual perception does not mean that identical verbal elements can be overlooked due to the presence of striking figurative elements, as can be seen in the case below, where likelihood of confusion was found for goods in Class 25.

Earlier sign	Contested sign	Case No
	FISHBONE	29/09/2011 <a href="#">T-415/09</a> , EU:T:2011:550  (appeal 18/07/2013, <a href="#">C-621/11 P</a> , EU:C:2013:484, dismissed)

In a similar way, the visual impression for marks covering *video games* has also been held to be particularly relevant because these goods are normally purchased after a comprehensive examination of their respective specifications and technical characteristics, firstly upon the basis of information that appears in specialist catalogues or on the internet, and then at the point of sale. For these reasons, the visual differences were key to the finding of no likelihood of confusion below (08/09/2011, [T-525/09](#), Metronia, EU:T:2011:437, § 38-47).

Earlier sign	Contested sign	Case No
		<a href="#">T-525/09</a>

The visual similarity between signs may also have an increased importance where the goods are **ordinary consumer products** (e.g. goods in Classes 29 and 30) that are most commonly purchased in supermarkets or establishments where goods are arranged on shelves and where consumers are guided more by the visual impact of the mark they are looking for. Consequently, for such goods, the visual differences were central to a finding of no likelihood of confusion in the United Kingdom between the marks below.

Earlier sign	Contested sign	Case No
	EGLÉFRUIT	15/04/2010, <a href="#">T-488/07</a> , EU:T:2010:145

However, the broad principle above does not mean that, for goods that are normally purchased visually, the phonetic impression can be overlooked. This latter point was highlighted in a case involving the marks below where the General Court, confirming

the finding of a likelihood of confusion, held that, although *computers and computer accessories* are sold to consumers ‘as seen’ on shelves in self-service areas, the phonetic identity between the marks at issue was, in this case, at least as important as their visual similarity because an oral discussion of the characteristics of the goods and their mark is also likely to take place at the time of purchase. Furthermore, those goods could be advertised orally, on the radio or by other consumers.

Earlier sign	Contested sign	Case No
CMORE		23/09/2011, <a href="#">T-501/08</a> , EU:T:2011:527

## 4.2 Aural similarity

In contrast to the cases above, where visual similarity played a stronger role, the aural similarity may have more weight than the visual when the goods or services at issue are, in a significant amount of cases, also ordered orally.

Where goods are ordered orally, the phonetic perception of the sign may also be influenced by factors such as the likely presence of various other sounds perceived by the recipient of the order at the same time. Such considerations are relevant where the goods in question are normally ordered at sales points with an increased noise factor, such as **bars or nightclubs**. In such cases, attaching particular importance to the aural similarity between the signs at issue may be appropriate. These considerations came into play in the finding of likelihood of confusion between the marks below for certain goods in Class 33 (15/01/2003, [T-99/01](#), *Mystery*, EU:T:2003:7, § 48).

Earlier sign	Contested sign	Case No
MIXERY		<a href="#">T-99/01</a>

Nevertheless, the broad principle above does not mean that the visual impression can be overlooked for goods normally purchased orally. Indeed, the General Court has held that although preponderant importance had sometimes been accorded to the phonetic perception of marks for beverages, the phonetic dissimilarities of the marks did not merit particular importance where the specific beverages were widely distributed and sold not only in specialist shops, where they would be ordered orally, but also in large shopping centres, where they would be purchased visually (03/09/2010, [T-472/08](#), 61 a nossa alegria, EU:T:2010:347, § 106).



### 4.3 Conclusion

The circumstances set out above demonstrate that in certain situations the Office should grant preferential consideration to the visual or aural perception of marks depending on how the goods and services at issue are ordered or purchased. However, identical or highly similar visual or aural elements cannot be entirely overlooked even in these situations because all the relevant factors are interlinked and interdependent, and each set of circumstances must be examined on a case-by-case basis.

## 5 Impact of conceptual comparison on the likelihood of confusion

A conceptual **similarity** between signs with **analogous** semantic content may give rise to a likelihood of confusion where the earlier mark is particularly distinctive (11/11/1997, [C-251/95](#), Sabèl, EU:C:1997:528, § 24, where the signs shared the broader concept of a 'bounding feline', but did not evoke the same animal: a puma in the earlier mark and a cheetah in the contested mark).

However, exceptionally, where the signs have the **same** distinctive concept in common accompanied by visual similarities between the signs, this may lead to a likelihood of confusion even in the absence of a particularly high degree of distinctiveness of the earlier mark, as illustrated by the following example.

Earlier sign	Contested sign	Case No
		14/12/2006, <a href="#">T-81/03</a> , <a href="#">T-82/03</a> & <a href="#">T-103/03</a> , Venado, EU:T:2006:397
<p>G&amp;S: Classes 32, 33</p> <p><i>Territory:</i> Spain (where 'venado' means 'deer')</p> <p><i>Assessment:</i> The Court found that the signs had the same concept and that there was significant visual similarity. In the absence of a clear semantic link between a deer or a deer's head and alcoholic or non-alcoholic beverages, the Court found it impossible to deny that the concept of a deer's head portrayed facing forward inside a circle had at least average distinctive character for designating beverages (para. 110). Enhanced distinctiveness was not considered – likelihood of confusion (for the Spanish public).</p>		

A conceptual similarity between the signs may not be sufficient to outweigh the visual and phonetic differences where the concept in common is non-distinctive.



Earlier sign	Contested sign	Case No
K2 SPORTS		31/01/2013, <a href="#">T-54/12</a> , Sport, EU:T:2013:50
<p>G&amp;S: Classes 18, 25, 28</p> <p><i>Territory:</i> Germany and the United Kingdom</p> <p><i>Assessment:</i> Contrary to the Board's finding that there is no conceptual similarity, the term 'sport', notwithstanding its descriptive character, refers to the same concept and leads to the conclusion that there is a degree of conceptual similarity. The Court concluded that this similarity was weak in the context of the overall impression of the signs and in particular of the very weak distinctive character of this term. However, the weak conceptual similarity did not offset the significant visual and phonetic differences between the signs (para. 49) – no likelihood of confusion.</p>		

In exceptional cases, conceptual dissimilarity offsets the visual and aural similarity between the signs resulting in a finding that the signs are not similar. This is called 'neutralisation' (see the Guidelines, [Part C, Opposition, Section 2, Double identity and likelihood of confusion, Chapter 4, Comparison of signs, paragraph 3.4.6.4, The impact of conceptual difference](#)). However, more commonly, conceptual dissimilarity does not result in neutralisation and must be taken into account in the global assessment where the outcome could be no likelihood of confusion despite phonetic and/or visual similarities of the signs.

Earlier sign	Contested sign	Case No
Conlance	SONANCE	26/03/2020, <a href="#">T-343/19</a> , Sonance / Conlance, EU:T:2020:124
<p>G&amp;S: Class 9</p> <p><i>Territory:</i> Germany</p> <p><i>Assessment:</i> The Court accepted the Board's findings that the German public will make an association with the contested goods through the meaning of the word 'SONANCE' in English (being an allusion to sound) and the fact that there are several German words with the same roots (paras 51,53). Since the contested sign conveys a meaning to the relevant public, whereas this is not the case with the earlier mark 'conlance', those signs must be regarded as conceptually dissimilar (paras 51, 54). The Court denied the existence of likelihood of confusion, even for identical goods, despite the signs' visual similarity to no more than an average degree and a slight or very slight phonetical similarity (para. 61) – no likelihood of confusion (paras 63-64).</p>		



## 6 Impact on Likelihood of Confusion of Components that are Non-Distinctive or Distinctive Only to a Low Degree

When assessing the similarity of the signs, an analysis of whether the coinciding components are descriptive, allusive or otherwise weak is carried out in order to calculate the extent to which these coinciding components have a lesser or greater capacity to indicate commercial origin. It may be more difficult to establish that the public may be confused as to origin due to similarities that solely pertain to non-distinctive elements (see the Guidelines, [Part C, Opposition, Section 2, Double Identity and Likelihood of Confusion, Chapter 5, Distinctiveness of the Earlier Mark](#)).

Endeavouring to converge trade mark practices, the European Trade Mark and Design Network (now European Union Intellectual Property Network) published a Common Communication on the Common Practice of Relative Grounds of Refusal – Likelihood of Confusion (Impact of non-distinctive/weak components) on 2 October 2014 ([CP5](#))<sup>(67)</sup>.

### 6.1 Common components with a low degree of distinctiveness

According to [CP5](#), when marks share an element with a **low degree of distinctiveness**, the assessment of likelihood of confusion will focus on the impact of the non-coinciding components on the overall impression of the marks, as previously assessed in the comparison of signs. That assessment takes into account the similarities/differences and distinctiveness of the non-coinciding components.

A coincidence in an element with a low degree of distinctiveness **will not normally on its own lead to likelihood of confusion**. However, there may be likelihood of confusion if the other components are of a lower (or equally low) degree of distinctiveness or are of insignificant visual impact and the overall impression of the marks is similar. There may also be likelihood of confusion if the overall impression of the marks is highly similar or identical.

**No likelihood of confusion** was found in the following examples.

Earlier sign	Contested sign	Case No
	TORO XL	24/05/2012, <a href="#">T-169/10</a> , EU:T:2012:261

<sup>67</sup> Available at <https://www.tmdn.org/network/converging-practices>

G&S: Class 33 *Alcoholic beverages*

Territory: EU

*Assessment:* The coinciding letters 'XL' have a low degree of distinctiveness for the goods in question. 'XL' is an abbreviation of extra-large size used within the whole EU. For the goods in question, namely *alcoholic beverages*, the public is likely to associate it with an extra quantity of a drink (paras 34, 35). The word element TORO is distinctive (para. 42).

The marks are visually, and phonetically dissimilar (paras 46, 48) and there is only a weak conceptual similarity (para. 52). The likelihood of confusion is excluded (para. 57)

Earlier sign	Contested sign	Case No
ZITRO SPIN BINGO,		29/01/2015, <a href="#">T-665/13</a> , SPIN BINGO, EU:T:2015:55

G&S: Classes 9, 41, 42 in relation to *games*

Territory: EU

*Assessment:* The word 'bingo' is descriptive of the corresponding game of chance, the English word 'spin' alludes to a rotating object or to the action of spinning something (para. 36).

The Court confirmed the Board's finding that there was a low degree of visual, aural and conceptual similarity between the signs at issue, despite the fact that they contain the expression 'spin bingo'. Visually, the degree of similarity is low because, regarding the earlier sign, the public would pay attention to the more distinctive element 'zitro', which is devoid of any meaning in the relevant languages and is at the beginning of the sign. Concerning the contested sign, consumers will pay as much attention to the different colour elements of the device, which are the circles and the reel on which there is a representation of a smiling face. Aurally, the similarity was weak as well in the light of the descriptive meaning of the expression 'spin bingo', and the fact that the public will pay attention to the more distinctive element 'zitro'. Conceptually, the word 'zitro' was dominant and was not similar to the contested sign (paras 11, 44). There is no likelihood of confusion.

Earlier sign	Contested sign	Case No
--------------	----------------	---------

	<p>CLUB GOURMET</p>	<p>28/07/2011,  <a href="#">R 1946/2010-1</a>,                  confirmed 20/03/2013, <a href="#">T-571/11</a>,                  appealed, 06/02/2014,  <a href="#">C-301/13 P</a></p>
<p>G&amp;S: Classes 16, 21, 29, 30, 32, 33</p> <p><i>Territory:</i> Spain</p> <p><i>Assessment:</i> The conflicting signs only share the two words 'CLUB' and 'GOURMET'. However, they differ in all their other characteristics. First, the dominant and distinctive element of the earlier sign is not reproduced in the contested sign. Second, the verbal element 'CLUB GOURMET' differs from the verbal element 'CLUB DEL GOURMET': the earlier sign has 14 letters (whilst the contested sign has 11) and it is separated by the word 'DEL' and followed by a comma. Finally, they differ with respect to the following aspects: the number of words (seven for the earlier sign, two for the contested sign), the use of punctuation marks (',' and '...' in the earlier sign), the triangle (which is absent in the contested sign and contains no figurative element at all) and the font (which is partly stylised in the earlier sign). The common elements 'CLUB' and 'GOURMET' only have a weak distinctive character in relation to the goods and services at issue. Indeed, there exists, for the relevant consumer, a strong conceptual link between the verbal element 'CLUB DEL GOURMET' and the goods provided for by the opponent's services, which mainly consist of food and beverages. In the consumer's mind, 'GOURMET' refers to the idea of a connoisseur or lover of good food or a person with a discerning palate, that is to say, someone who appreciates good food and drink. Although it sounds and is of French origin, the meaning will be immediately grasped by the Spanish consumer (paras 39, 40).</p>		

In the following example there was a likelihood of confusion because other components are of a lower (or equally low) degree of distinctiveness or are of insignificant visual impact and the overall impression of the marks is similar.

Earlier sign	Contested sign	Case No
		<p>11/02/2015,                  Solidfloor The Professional's choice (fig.) / SOLID floor (fig.),  <a href="#">T-395/12</a>,                  EU:T:2015:92</p>

*Territory:* United Kingdom

*G&S:* Class 19.

*Assessment:* The word element ‘solid floor’ of the earlier mark is only of weak distinctive character (para. 32), but the differentiating element in the contested sign, ‘The professional’s choice’, will be perceived by the relevant public as a clearly laudatory and banal slogan with no trade mark connotations that would allow them to perceive it as a badge of origin (para. 34) and the figurative elements of the signs at issue are limited (para. 35).

There is a [average] visual similarity and a high degree of phonetic and conceptual similarity (paras 36, 38, 40).

There is a likelihood of confusion for identical and similar goods, namely *building materials, not of metal, parquet flooring of plastic and wood, flooring of wood, cork and laminate; subfloors; transportable floors, not of metal.*

There may also be likelihood of confusion if the overall impression of the marks is highly similar or identical.

Earlier sign	Contested sign	Case No
waterPerfect	AquaPerfect	28/01/2015, <a href="#">T-123/14</a> , EU:T:2015:52

*G&S:* Class 7

*Territory:* EU

*Assessment:* while the element ‘Perfect’ has a laudatory character, the fact remains that none of the other elements in the signs can be considered to have a greater distinctive character or be dominant. The elements ‘aqua’ and ‘water’ also have a weak distinctive character owing to the fact that they will be perceived by the relevant public as meaning ‘water’ and the goods covered all involve, in one way or another, *water* (para. 42). Visually and phonetically, the similarity of the signs at issue is not limited to the presence of the term ‘perfect’ within each of those two signs, since those signs also have the same length and the same number of syllables, that are identically stressed, and an almost identical sequence of vowels; based on an overall impression, the similar elements between the signs referred to prevail globally over the dissimilar elements (paras 28, 32). The signs were found visually, phonetically and conceptually similar to an **average** degree (paras 32-33, 40).



Further examples where the common component is of a low distinctive character can be found in [CP5](#).

## 6.2 Common components with no distinctiveness

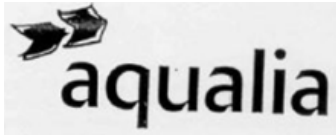

According to [CP5](#), when marks share an element with **no distinctiveness**, the assessment will focus on the impact of the non-coinciding components on the overall impression of the marks. The assessment will take into account the similarities/differences and distinctiveness of the non-coinciding components.

A coincidence only in non-distinctive components **does not lead to a likelihood of confusion**. However, when marks also contain other figurative and/or word elements that are similar, there will be likelihood of confusion if the overall impression of the marks is highly similar or identical.

**No likelihood of confusion** was found in the following example, as the signs coincide solely in a non-distinctive element.

Earlier sign	Contested sign	Case No
		25/02/2016, <a href="#">T-402/14</a> , AQUALOGY (fig.) / AQUALIA et al., EU:T:2016:100
<p>G&amp;S: Classes 35, 37, 39, 40, 42</p> <p>Territory: EU</p> <p><i>Assessment:</i> The relevant specialised public will not pay much attention to the descriptive element 'AQUA', the only common element of the conflicting signs (paras 84-85). The figurative elements of the signs are totally different. They are basic but not insignificant, so they must be taken into account in the overall impression of the signs (paras 54-55). There is a low degree of visual similarity. There is a low degree of phonetic and conceptual similarity, even though the different suffixes allow the specialised public to gather a different conceptual content (paras 71-73). The differences between the signs are sufficient to exclude the likelihood of confusion, even for identical services and taking into account that the earlier trade mark, as a whole, has an enhanced distinctiveness (para. 86).</p>		

**Likelihood of confusion** was found in the following examples because the marks also contain other figurative and/or word elements that are similar, and the overall impression of the marks is highly similar or identical.

Earlier sign	Contested sign	Case No
		20/07/2016, <a href="#">T-745/14</a> , easy Credit (fig.), EU:T:2016:423

G&S: Classes 36, 38

Territory: Bulgaria

*Assessment:* The signs at issue are visually highly similar and phonetically and conceptually identical, given that they coincide in their word elements. The fonts used for the word elements are very common and do not make it possible to detect any particular difference between them (paras 28-44).

Earlier sign	Contested sign	Case No
BIOCERT	BIOCEF	10/12/2014, <a href="#">T-605/11</a> , EU:T:2014:1050
<p>G&amp;S: Class 5</p> <p>Territory: Austria</p> <p><i>Assessment:</i> Although the element 'BIO' is descriptive for the goods in question, the trade marks coincide not only in these three letters, but also in their fourth and fifth letters, 'c' and 'e' (para. 38). The difference in the last letters, 'rt' versus 'f', does not counteract the important similarity arising from the fact that the first five letters at the centre of the two signs, which are of very similar length, are identical (para. 39). There is an average degree of visual and phonetic similarity (paras 40, 46), whereas the conceptual comparison is neutral (para. 48).</p>		

Further examples where the common component is non-distinctive can be found in [CP5](#).

### 6.3 Distinctiveness of the earlier mark versus distinctiveness of the common component

The abovementioned examples concern the coincidence in a weakly distinctive or non-distinctive element of the marks. The distinctiveness of an element of the mark is a separate question from the assessment of the distinctiveness of the earlier mark as a whole (see the Guidelines, [Part C, Opposition, Section 2, Double Identity and Likelihood of Confusion, Chapter 5, Distinctiveness of the Earlier Mark, paragraph 2](#)). The enhanced distinctiveness of the earlier mark does not automatically lead to an enhanced distinctiveness of the common element (e.g. 25/02/2016, [T-402/14](#), AQUALOGY (fig.) / AQUALIA et al., EU:T:2016:100, in [paragraph 6.2](#)).

However, when the earlier trade mark is entirely contained in the contested EUTM application and recognisable as such, its degree of distinctiveness naturally equals that of the coinciding element, with the following consequences.

The analysis of the cases where the earlier mark is entirely contained in the contested EUTM application cannot follow the principles established in [paragraph 6.2](#) above (Common components with no distinctiveness) but rather those established in

[paragraph 6.1](#) (Common components with a low degree of distinctiveness). This is because the Office applies the practice clarified in the judgment of 24/05/2012, [C-196/11 P](#), F1-Live, EU:C:2012:314, namely that in proceedings opposing the registration of an EUTM application, the validity of earlier trade marks may not be called into question. Consequently, the elements corresponding to the earlier mark cannot be considered as devoid of distinctive character in the trade mark comparison, but must be deemed to be endowed with some (low/minimal) degree of distinctiveness (see the Guidelines, [Part C, Opposition, Section 2, Double Identity and Likelihood of Confusion, Chapter 4, Comparison of Signs, paragraph 3.2.3.5](#)).

If the earlier mark contained in the contested EUTM application enjoys enhanced distinctiveness through use despite low inherent distinctiveness, the common element corresponding to that mark cannot be considered distinctive to a low degree and the principles of [CP5](#) mentioned in paragraphs [6.1](#) and [6.2](#) do not apply.

Earlier sign	Contested sign	Case No
MINI		23/01/2015, <a href="#">R 596/2014-4</a> , MINICARGO (fig.) / MINI  confirmed 10/03/2016, <a href="#">T-160/15</a> , MINICARGO (fig.) / MINI, EU:T:2016:137
<p>G&amp;S: Class 12</p> <p>Territory: United Kingdom</p> <p>Assessment: The earlier trade mark is reputed for cars, and accordingly, it has enhanced distinctive character in the UK. Thus, for the relevant public in the UK, the contested composite sign will be perceived as the widely-known trade mark 'MINI' in combination with the descriptive word 'CARGO'. This is as a direct consequence of the earlier trade mark's repute in the field of motor vehicles (paras 19, 25-26).</p>		

## 7 Specific Cases

### 7.1 Short signs

As indicated before, the Courts have not exactly defined what a short sign is. However, signs with three or fewer letters/numbers are considered by the Office as short signs.

The General Court held that the global assessment of the likelihood of confusion between signs consisting of a single letter (or a combination of letters not recognisable as a word) **follows the same rules** as that in respect of word signs comprising a word, a name or an invented term (06/10/2004, [T-117/03](#) – [T-119/03](#) & [T-171/03](#), NL, EU:T:2004:293, § 47-48; 10/05/2011, [T-187/10](#), G, EU:T:2011:202, § 49).

In the assessment of the likelihood of confusion it is important to establish the degree of **inherent distinctiveness** of the earlier trade mark, and therefore its scope of protection. See in this respect the Guidelines, [Part C, Opposition, Section 2, Double Identity and Likelihood of Confusion, Chapter 5, Distinctiveness of the Earlier Mark, paragraph 2.2.3.1](#).

As to the overall assessment of likelihood of confusion, the Court made it clear that the fact that two trade marks consisting of the same letter (or of the same sequence of letters) are found to be identical from an aural and a conceptual point of view is relevant when it comes to assessing the existence of a likelihood of confusion. In such cases, it is only when the later trade mark causes a **sufficiently different visual impression** that a likelihood of confusion can be safely ruled out (10/05/2011, [T-187/10](#), G, EU:T:2011:202, § 60).

Consequently, a likelihood of confusion can be safely excluded when two conflicting signs, albeit containing or consisting of the same single letter or a combination of letters not recognisable as a word, are stylised in a sufficiently different way or contain a sufficiently different figurative element, so that their different overall graphical representation eclipses the common verbal element. See examples in the Guidelines, [Part C, Opposition, Section 2, Double Identity and Likelihood of Confusion, Chapter 4, Comparison of Signs, paragraph 3.4.1.7](#).

Where the opponent has successfully proven that its earlier mark has acquired enhanced distinctiveness through intensive use or reputation, the impact thereof on the final outcome has to be carefully assessed. Firstly, enhanced distinctiveness on the part of an earlier mark containing or consisting of a single letter or a combination of letters cannot justify a finding of a likelihood of confusion if the overall visual impression of the signs is so different as to safely set them apart. Secondly, if the evidence shows use of a single letter or combination of letters stylised or accompanied by additional figurative elements, the benefit of the resulting broader scope of protection accrues to the form in which it was used and not to the single letter as such or any other stylised variation.

## 7.2 Names

When assessing the likelihood of confusion between signs containing names there are certain specificities that must be taken into account, as explained in paragraphs [7.2.1](#) and [7.2.2](#).

### 7.2.1 Personal names

The objective visual, phonetic and conceptual similarities resulting from an overlap in a first name or a surname, even where the goods and services at issue are identical and concern the public at large with an average degree of attention, are not decisive as to the question of likelihood of confusion. Rather, what is decisive is the relative importance to be attributed to an overlap in a first name or surname.



The perception of signs made up of personal names may vary from country to country within the European Union. Surnames have, in principle, a higher intrinsic value as indicators of the origin of goods or services than first names. This is because common experience shows that the same first names may belong to a great number of people who have nothing in common, whereas the presence of the same surname could imply the existence of some link between them (identity of the persons or a family link).

There are instances where the applicants invoke, as a defence, their right to use their name. However, that argument is not valid in opposition proceedings since it does not influence the issue of whether there will be likelihood of confusion on the part of the public. Furthermore, the registration of trade marks does not hinder the use of names of natural persons, due to the special protection provided by [Article 14\(1\)\(a\) EUTMR](#) and the relevant national trade mark laws according to [Article 14\(1\)\(a\) of Directive \(EU\) 2015/2436](#) of the European Parliament and of the Council of 16 December 2015 to approximate the laws of the Member States relating to trade marks.

#### 7.2.1.1 First name versus first name and surname – overlap in the first name

As indicated in the Guidelines, [Part C, Opposition, Section 2, Double Identity and Likelihood of Confusion, Chapter 4, Comparison of signs, paragraph 3.4.4.8](#), more weight is generally given to a surname than a first name regardless of how rare the first name could be. This is due to the fact that the surname allows clear identification of a particular family and if accompanied by a first name, a specific individual. A first name, however, does not identify a specific individual.

However, whilst bearing in mind the abovementioned general principle, it is appropriate to consider whether or not the first name or surname is rare or common as this has an important impact on the weighting to be given to each and on the overall assessment (24/06/2010, [C-51/09 P](#), Barbara Becker, EU:C:2010:368, § 36; 22/05/2019, [T-197/16](#), ANDREA INCONTRI / ANDREIA et al., EU:T:2019:347, § 51).

The mere fact that a first name or a surname is not in use in a particular country does not prevent it from being perceived as a foreign first name or surname provided that there are sufficient indications to support that finding (08/02/2019, [T-647/17](#), CHIARA FERRAGNI (fig.) / Chiara, EU:T:2019:73, § 70). This is particularly the case with first names or surnames recognised after internationally known personalities or where a similar equivalent exists in the country.

Whenever two signs share the same first name and one of them also contains a surname, in general, there will be **no likelihood of confusion**.

Earlier sign	Contested sign	Case No
--------------	----------------	---------

CHIARA		08/02/2019, <a href="#">T-647/17</a> , CHIARA FERRAGNI (fig.) / Chiara
<p>G&amp;S: Classes 18, 25</p> <p><i>Territory:</i> Benelux</p> <p><i>Assessment:</i> Even if it was common in the sector to sell the products not only under a first name and a surname but also only under a first name only, this does not mean that the public will always attribute the same commercial origin to all the products put on the market under trade marks containing the same first name (para. 71). The surname Ferragni is less common than the first name Chiara – no likelihood of confusion.</p>		

However, when a first name is likely to be perceived to be **rare** in the relevant territory and is accompanied by a surname which is perceived as very common, the presence of this uncommon element is likely to focus the consumer's attention and they could be misled into attributing a common origin to the goods and services concerned.

Earlier sign	Contested sign	Case No
AMANDA	AMANDA SMITH	17/03/2009, <a href="#">R 1892/2007-2</a>
<p>G&amp;S: Classes 29, 30</p> <p><i>Territory:</i> Spain</p> <p><i>Assessment:</i> The term 'SMITH' in the trade mark application will be perceived by the Spanish consumers as a common Anglo-Saxon surname and will have less weight than the first name 'AMANDA' (which is less common in Spain) (para. 31) – likelihood of confusion.</p>		

#### 7.2.1.2 First name and surname versus first name and surname – overlap in the first name

When the signs share the same first name but are accompanied by different surnames, in general, there will be **no likelihood of confusion**. Consumers will note that they distinguish goods and services of different, unconnected undertakings.

Earlier sign	Contested sign	Case No
JAUME SERRA	JAUME CODORNÍU	08/05/2019, <a href="#">T-358/18</a> , JAUME CODORNÍU / JAUME SERRA et al., EU:T:2019:304

G&S: Class 33

*Territory:* EU

*Assessment:* Even though the signs share the same first name, they have different surnames and thus refer to different families and different persons. In a sector such as wines or alcoholic beverages, the use of a combination of a first name and a surname constitutes a common practice. The relevant public will identify the conflicting signs as consisting of a first name and a surname. The first name has a lower distinctive character than the surname. Consequently, the protection conferred will cover the sign of the earlier trade mark as a whole and not each of its elements separately. Therefore, the coincidence of the words 'Jaume' in the conflicting signs does not generate an overall impression of similarity that entails a risk of confusion (para. 87) – no likelihood of confusion.

### 7.2.1.3 First name and surname versus first name and surname – overlap in the surname

When the conflicting signs contain the same surname preceded by different first names, the outcome will very much depend on the perception of the surname in the relevant territory. The less common a surname is, the more likely it is that it will attract the consumers' attention (regardless of whether the first names are common or not).

Earlier sign	Contested sign	Case No
ANTONIO FUSCO	ENZO FUSCO	01/03/2005, <a href="#">T-185/03</a> , EU:T:2005:73

G&S: Classes 3, 9, 18, 24, 25

*Territory:* EU

*Assessment:* Since the Italian consumer generally attributes greater distinctiveness to the surname than the first name, it will be the (neither rare nor common) surname 'Fusco' that sticks in their mind rather than the (common) first names 'Antonio' or 'Enzo'. Therefore, a consumer faced with goods bearing the trade mark applied for, ENZO FUSCO, might confuse it with the earlier trade mark, ANTONIO FUSCO (paras 53, 67) – likelihood of confusion.

In contrast, when the signs share a surname that is perceived to be a common surname in the relevant territory, consumers will not normally be misled into attributing a common origin to the goods and services. Consumers are used to trade marks that contain common surnames and will not blindly assume that every time a common surname occurs in two conflicting signs the goods/services in question all emanate from the same source.

Earlier sign	Contested sign	Case No
MISS ROSSI	SISSI ROSSI	01/03/2005, <a href="#">T-169/03</a> , EU:T:2005:72  Appeal dismissed, 18/07/2006, <a href="#">C-214/05 P</a> , EU:C:2006:494
<p>G&amp;S: Class 18, 25</p> <p><i>Territory:</i> FR, IT</p> <p><i>Assessment:</i> The surname 'Rossi' is very common and a typical Italian surname, not only in the eyes of Italian consumers but also in the eyes of French consumers. In a sector such as that of clothing and fashion, in which it is common to use marks consisting of patronymics, it may be assumed, as a general rule, that a very common name will appear more frequently than a rare name. Thus, consumers will not believe that there is an economic link between all the proprietors of marks containing the surname 'Rossi'. Accordingly, they will not believe that the undertakings selling bags under the trade mark SISSI ROSSI are economically linked or identical to those selling shoes under the trade mark MISS ROSSI (paras 82-83) – no likelihood of confusion.</p>		

#### 7.2.1.4 Surname versus first name and surname – overlap in the surname



When two signs contain the same surname but only one of them also contains a first name, in general, there will be a **likelihood of confusion**. Consumers might be misled and attribute a common origin to the goods and services concerned. The surname alone will be perceived as the short version of the full name, thus identifying the same origin.

Earlier sign	Contested sign	Case No
MURÚA		13/07/2005, <a href="#">T-40/03</a> , Julián Murúa Entrena, EU:T:2005:285

G&S: Class 33

*Territory:* Spain

*Assessment:* It is common ground that the Spanish public will perceive the verbal element making up the trade mark applied for as a proper name (first name plus surnames) and the earlier trade mark as a surname. It is quite likely that the relevant public will regard the addition, in the trade mark applied for, of the first name 'Julián' and the surname 'Entrena' merely as a way of distinguishing a range of wines produced by the undertaking that owns the earlier trade mark or, at least, an undertaking economically linked to the intervener (paras 42, 78) – likelihood of confusion.

Earlier sign	Contested sign	Case No
(i) MARSHALL  (ii) 		08/11/2017, <a href="#">T-271/16</a> , Thomas Marshall Garments of Legends (fig.) / MARSHALL et al., EU:T:2017:787

G&S: Classes 9, 16, 28, 41

*Territory:* EU

*Assessment:* The surname 'Marshall' is not common. There will be likelihood of confusion for at least the English speaking part of the public in view of the identity or high similarity of goods and visual, phonetic and conceptual similarity between the signs (on the basis of the common element 'Marshall') (paras 91, 96, 108) – likelihood of confusion.

#### 7.2.1.5 First name versus first name

If the signs are understood as variants of the same first name in use in the same country or if one is understood as a foreign equivalent of the other first name, this is an argument in favour of a **likelihood of confusion**. Nevertheless, visual and phonetic differences between variants of first names must also be taken into account.

Earlier sign	Contested sign	Case No
ELISE		24/03/2010, <a href="#">T-130/09</a> , Eliza, EU:T:2010:120

G&S: Classes 9, 42

*Territory:* EU

*Assessment:* The signs at issue are visually and phonetically similar. They are conceptually identical in the Member States where they are perceived as diminutives of the female first name Elizabeth (such as Ireland, Germany or Austria), and conceptually highly similar elsewhere where they are considered as highly similar female first names derived from the same root. The earlier mark, being a female personal first name, has at least average distinctiveness for the goods and services it covers. Given that the goods and services at issue are identical or similar, notwithstanding the high degree of attentiveness which may be expected from the relevant public, there is a likelihood of confusion (paras 40-43) – likelihood of confusion.

### 7.2.1.6 Surname versus surname

If the signs are understood as variants of the same surname in use in the same country or if one is understood as a foreign equivalent of the other surname, there will be a **likelihood of confusion**.

Earlier sign	Contested sign	Case No
Schmidt	Smith	Invented example
<p>G&amp;S: similar</p> <p><i>Territory:</i> Germany</p> <p><i>Assessment:</i> The surname 'Smith' comprising the contested sign will be understood as a <b>foreign variant</b> of the surname 'Schmidt' in Germany. The signs are visually similar to an average degree, phonetically similar to a low degree and conceptually similar – likelihood of confusion.</p>		



### 7.2.2 Business names in combination with other components

The assessment of the likelihood of confusion may be influenced by the fact that one of the signs contains several verbal elements, where one such element could be seen as a business name, that is to say, indicating a specific trade origin (typically, a company name preceded by the preposition 'by').

In such a situation, either element (i.e. the business name or the element typically indicating the mark designating the line of product) may become more relevant in the overall impression of the sign, even if it has a lower degree of distinctiveness or is visually less prominent. This is because in such a situation, both elements of the sign (i.e. the business name and the mark designating the product line) will in principle play an independent distinctive role even where the distinctiveness *per se* of one of them is lower. On account of this particular configuration of the sign the consumer will perceive

the elements independently, as each indicating an aspect of the commercial origin of the goods or services designated by it (e.g. a business name and a mark designating the product line).

Consequently, if the earlier mark is identical (or highly similar) to either element (the business name or the mark designating the product line), even if it is the one that otherwise would be less relevant (e.g. due to its size or due to its lower distinctiveness), there will, in principle, be a likelihood of confusion.

Earlier sign	Contested sign	Case No
		09/04/2014, <a href="#">T-386/12</a> , EU:T:2014:198
<p>G&amp;S: Classes 32, 38, 39</p> <p><i>Territory:</i> United Kingdom</p> <p><i>Assessment:</i> In the present case, the particular structure of the mark applied for must also be taken into account. As the Opposition Division has pointed out, the presence within the mark applied for of the preposition ‘by’ will lead the consumer, insofar as they understand the meaning, to think that the mark applied for consists of two brands, the sub-brand ‘elite’ and the main brand ‘Mondariz’. As a consequence, the word ‘elite’ will not be perceived as a mere denomination of one of the characteristics of the goods and services it designates, but rather as an independent and distinct part of the mark in question. That element is likely to reinforce the similarity between the signs at issue, regardless of the higher or lesser intrinsic distinctiveness of the word ‘elite’ (para. 107) — likelihood of confusion.</p>		
RICCI		15/09/2016, <a href="#">T-358/15</a> , EU:T:2016:490

G&S: Classes 3, 25, 35



Territory: EU

*Assessment:* It is also necessary to reject the applicant's argument that the dominant element of the mark applied for is 'roméo has a gun', owing to its initial position and greater size in relation to the word element 'by romano ricci'. The relevant public would not pay attention only to the first word element of the mark applied for, but would seek to supplement it, inasmuch as it gave the impression of the title of, or citation from, an artistic work. The word element 'by romano ricci' thus has the effect, as the Board of Appeal stated in paragraph 31 of the contested decision, of giving further meaning to the first word element of the earlier mark RICCI, which confers on it an independent distinctive position. Furthermore, the Office is correct in submitting that it is usual in the field of fashion as regards personal care items and high fashion clothing to refer to the designer or source of a product, using the same format as that used by the mark applied for. In that field, the designer or source of a product, in particular, is likely to play a more important role for the relevant public than for other categories of goods. Therefore, the word element 'romano ricci' is of such a nature as to be perceived as the mark of the house, while the element 'roméo has a gun' will be perceived as the sign identifying a particular line of goods or services among a wider range of goods and services offered by the applicant (para. 46) — likelihood of confusion.

### 7.3 Colour marks per se

When the likelihood of confusion of two colour marks per se is assessed, a phonetic or conceptual comparison of the signs cannot be made and the visual similarities will depend on the colour of the signs.

In the overall assessment, the Office takes into account the fact that there is a 'public interest in not unduly restricting the availability of colours for other traders who market goods or services of the same type as those in respect of which registration is sought' (24/06/2004, [C-49/02](#) Blau/Gelb, EU:C:2004:384, § 41; 06/05/2003, [C-104/01](#), Libertel, EU:C:2003:244, § 52-56). The inherent distinctiveness of colour marks per se is limited. The scope of protection should be limited to identical or almost identical colour combinations.

Earlier sign	Contested sign	Case No
		20/10/2010, <a href="#">R 755/2009-4</a>



G&S: Class 8

*Territory:* EU

*Assessment:* In the case at hand, the colour combinations, identified by different colour codes, are not sufficiently close to lead to a likelihood of confusion, taking into account that the inherent distinctiveness is limited (para. 18). The BoA referred to CJEU judgments and public interest in ensuring that colours remain available to competitors (para. 19). The opponent did not prove enhanced distinctive character (para. 25) — no likelihood of confusion.

## 7.4 Earlier collective and certification marks

As set out in the Guidelines, [Part C, Opposition, Section 2, Double Identity and Likelihood of Confusion, Chapter 1, General Principles](#) the ‘essential function’ of **individual** trade marks is to indicate commercial origin and the concept of ‘likelihood of confusion’ relates to detriment to this essential function (18/06/2009, [C-487/07](#), L’Oréal, EU:C:2009:378, § 58-59). The vast majority of cases where a likelihood of confusion is alleged relate to confusion regarding the commercial origin of goods or services covered by conflicting individual marks, that is, the particular undertaking they come from.

This is not so when the **earlier mark** is a **collective** or a **certification** mark.

The assessment of the likelihood of confusion in the latter cases must be made bearing in mind the different essential functions specific to those marks and will consist in assessing whether the contested mark (individual, collective or certification) causes detriment to that essential function, that is:

- for earlier collective marks, the risk that the public might believe that the goods or services covered by the earlier trade mark and those covered by the trade mark applied for all originate from members of the association that is the proprietor of the earlier trade mark or, where appropriate, from undertakings economically linked to those members or to that association (05/03/2020, [C-766/18 P](#), BBQLOUMI (fig.) / HALLOUMI, EU:C:2020:170, § 71).
- for earlier certification marks, the risk that the public might believe that the goods and services covered by the contested mark are certified by the proprietor of the earlier certification mark in respect of a characteristic denoted by that mark.

However, when the **contested** mark is a **collective** or **certification** mark, and the opposition is based on an individual mark, the usual assessment of the likelihood of confusion must be carried out (i.e. whether the public will think that the goods or services covered by the contested mark and by the earlier mark have the same commercial origin or that of economically linked undertakings).

***GUIDELINES FOR EXAMINATION OF  
EUROPEAN UNION TRADE MARKS***

***EUROPEAN UNION  
INTELLECTUAL PROPERTY OFFICE  
(EUIPO)***

***Part C***

***Opposition***

***Section 3***

***Unauthorised filing by agents of the TM  
proprietor (Article 8(3) EUTMR)***

## Table of Contents

<b>1 Preliminary Remarks.....</b>	<b>1157</b>
<b>1.1 Origin of Article 8(3) EUTMR.....</b>	<b>1157</b>
<b>1.2 Purpose of Article 8(3) EUTMR.....</b>	<b>1158</b>
<b>2 Entitlement of the Opponent.....</b>	<b>1158</b>
<b>3 Scope of Application.....</b>	<b>1159</b>
<b>3.1 Kinds of mark covered.....</b>	<b>1159</b>
<b>3.2 Origin of the earlier mark.....</b>	<b>1161</b>
<b>4 Conditions of Application.....</b>	<b>1163</b>
<b>4.1 Agent or representative relationship.....</b>	<b>1163</b>
4.1.1 Nature of the relationship.....	1163
4.1.2 Form of the agreement.....	1166
4.1.3 Territorial scope of the agreement.....	1168
4.1.4 Relevant points in time.....	1169
<b>4.2 Application in the agent's name.....</b>	<b>1171</b>
<b>4.3 Application without the proprietor's consent.....</b>	<b>1173</b>
<b>4.4 Absence of justification on the part of the applicant.....</b>	<b>1176</b>
<b>4.5 Relationship between the marks and between the goods and services</b> .....	<b>1178</b>
4.5.1 Protection beyond identical marks and identical goods and services.....	1179
4.5.2 Relationship between the marks.....	1180
4.5.3 Relationship between the goods and services .....	1181
4.5.4 Combined assessment.....	1183

## 1 Preliminary Remarks

According to [Article 8\(3\) EUTMR](#), upon opposition by the proprietor of an earlier trade mark, a trade mark will not be registered:

where an agent or representative of the proprietor of the trade mark applies for registration thereof in his own name without the proprietor's consent, unless the agent or representative justifies his action.

### 1.1 Origin of Article 8(3) EUTMR

[Article 8\(3\) EUTMR](#) has its origin in Article 6*septies* of the Paris Convention (PC), which was introduced into the convention by the Revision Conference of Lisbon in 1958. The protection it affords to trade mark proprietors consists of the right to prevent, cancel, or claim as their own unauthorised registrations of their marks by their agents or representatives, and to prohibit use thereof, where the agent or representative cannot justify its acts. Article 6*septies* PC reads as follows:

(1) If the agent or representative of the person who is the proprietor of the mark in one of the countries of the Union applies, without such proprietor's authorization, for the registration of the mark in his own name, in one or more countries of the Union, the proprietor shall be entitled to oppose the registration applied for, or demand its cancellation or, if the law of the country so allows, the assignment in his favour of the said registration, unless such agent or representative justifies his action.

(2) The proprietor of the mark shall, subject to the provisions of paragraph (1), above, be entitled to oppose the use of his mark by his agent or representative if he has not authorized such use.

(3) Domestic legislation may provide an equitable time limit within which the proprietor of a mark must exercise the rights provided for in this Article.

[Article 8\(3\) EUTMR](#) implements this provision only to the extent it gives the rightful proprietor the right to oppose applications filed without its authorisation. The other elements of Article 6*septies* PC are implemented by Articles [13](#), [21](#) and [Article 60\(1\)\(b\) EUTMR](#). [Article 60\(1\)\(b\) EUTMR](#) gives the proprietor the right to cancel unauthorised registrations, whereas Articles [13](#) and [21](#) EUTMR enable the proprietor to prohibit the use thereof and/or to request the transfer of the registration to its own name.

Since [Article 46 EUTMR](#) provides that an opposition may only be based on the grounds provided for in [Article 8 EUTMR](#), the additional rights conferred on the proprietor by the above provisions may not be invoked in opposition proceedings. Hence, any request by the opponent, either for the prohibition of use of the agent's mark, or for an assignment of the application to itself, will be dismissed as inadmissible.

In view of the specific subject matter for protection under [Article 8\(3\) EUTMR](#), while the use or lack of use made of the earlier rights may have a bearing on arguments regarding the justification for applying for the EUTM, the opponent cannot be obliged to

provide proof of use under [Article 47\(3\) EUTMR](#) for any earlier rights thereby relied upon (see the Guidelines, [Part C, Opposition, Section 7, Proof of use, paragraph 1.2](#)). This practice of the Office is also justified by the fact that [Article 47\(2\) and \(3\) EUTMR](#) refer to the ‘earlier mark’ in the meaning of [Article 8\(2\) EUTMR](#), which does not apply to [Article 8\(3\) EUTMR](#).

## 1.2 Purpose of Article 8(3) EUTMR

The unauthorised filing of a proprietor’s trade mark by its agent or representative is contrary to the general obligation of trust underlying commercial cooperation agreements of this type. Such a misappropriation of the proprietor’s mark is particularly harmful to its commercial interests, as the applicant may exploit the knowledge and experience acquired during its business relationship with the proprietor and, thus, improperly benefit from the proprietor’s effort and investment (11/11/2020, [C-809/18 P](#), MINERAL MAGIC, EU:C:2020:902, § 72).

Therefore, the purpose of [Article 8\(3\) EUTMR](#) is to safeguard the legitimate interests of trade mark proprietors against the arbitrary appropriation of their trade marks, by granting them the right to prohibit registrations by agents or representatives that are applied for without their consent.

[Article 8\(3\) EUTMR](#) is a manifestation of the principle that commercial transactions must be conducted in good faith. [Article 59\(1\)\(b\) EUTMR](#), which allows for the declaration of invalidity of an EUTM on the ground that the applicant was acting in bad faith, is the general expression of this principle.

In some respects, the protection granted by [Article 8\(3\) EUTMR](#) is narrower than that afforded by [Article 59\(1\)\(b\) EUTMR](#), because the applicability of [Article 8\(3\) EUTMR](#) is subject to the fulfilment of a number of additional conditions laid down in this provision. On the other hand, the protection could be seen as broader in other ways because [Article 8\(3\) EUTMR](#) might apply where an agent’s behaviour would not qualify as ‘bad faith’, for example, the agent acted on the incorrect but genuinely held assumption that it had consent to apply for the mark.

## 2 Entitlement of the Opponent

According to [Article 46\(1\)\(b\) EUTMR](#), the right to file an opposition on the grounds of [Article 8\(3\) EUTMR](#) is reserved only for the proprietors of earlier trade marks. This is in contrast both to [Article 46\(1\)\(a\) EUTMR](#), which stipulates that oppositions based on [Articles 8\(1\) or \(5\) EUTMR](#) may also be filed by authorised licensees, and to [Article 46\(1\)\(c\) EUTMR](#), which stipulates that for oppositions based on [Article 8\(4\) EUTMR](#), the right to file an opposition is also extended to persons authorised by national law to exercise the relevant rights.

It follows that since the right to oppose an EUTM application on the grounds of [Article 8\(3\) EUTMR](#) belongs exclusively to the proprietors of earlier trade marks,

oppositions filed in the name of third persons, be they licensees or otherwise authorised by the relevant national laws, will be dismissed as inadmissible due to lack of entitlement.

Case No	Comment
30/09/2009, <a href="#">R 1547/2006-4</a> , POWERBALL / POWERBALL (confirmed 16/11/2011, <a href="#">T-484/09</a> , Powerball)	The Board confirmed the OD decision rejecting the opposition based on <a href="#">Article 8(3) EUTMR</a> to the extent that the opponent was not the proprietor of the earlier right but merely claimed to be the licensee of the company Nanosecond Technology Co. Ltd.
Case No	Comment
14/06/2010, <a href="#">R 1795/2008-4</a> , ZAPPER-CLICK (on appeal, 03/10/2012, <a href="#">T-360/10</a> , ZAPPER-CLICK, EU:T:2012:517)	The respondent failed to meet the requirement regarding ownership of the trade mark, namely of the ownership of the registered mark ZAPPER-CLICK. On appeal, the Court did not address this point.

Likewise, if the opponent fails to prove that it was the rightful proprietor of the mark when the opposition was filed, the opposition will be dismissed without any examination of its merits due to lack of substantiation. The evidence required in each case will depend on the kind of right relied upon. The current proprietor may also invoke the rights of its predecessor in title if the agency/representation agreement was concluded between the previous proprietor and the applicant, but this needs to be duly substantiated by evidence.

### 3 Scope of Application

#### 3.1 Kinds of mark covered

[Article 8\(3\) EUTMR](#) applies to earlier ‘trade marks’ that have been applied for as EUTMs without their proprietor’s consent. However, [Article 8\(2\) EUTMR](#) does not apply to oppositions based on this ground, as it only enumerates the kinds of earlier rights on which an opposition may be entered under paragraphs (1) and (5) of the same article. Therefore, the kinds of rights on which an opposition based on [Article 8\(3\) EUTMR](#) may be entered needs to be determined in more detail, both as regards their nature and their geographical origin.

In the absence of any restriction in [Article 8\(3\) EUTMR](#) and in view of the need to provide the legitimate interests of the real proprietor with effective protection, the term ‘trade marks’ should be interpreted broadly and must be understood as including

**pending applications**, since there is nothing in this provision restricting its scope exclusively to registered trade marks.

For the same reasons, **unregistered marks or well-known marks** within the meaning of Article 6*bis* PC also fall within the term ‘trade marks’ within the sense of [Article 8\(3\) EUTMR](#). Consequently, both registered and unregistered trade marks are covered by this provision, to the extent that the law of the country of origin recognises rights of the latter kind.

In contrast, the express reference to ‘trade marks’ means that [Article 8\(3\) EUTMR](#) **does not apply to mere signs used in the course of trade**, other than unregistered trade marks. Likewise, **other kinds of intellectual property rights** that could be used as a basis for an invalidity action cannot be invoked in the context of [Article 8\(3\) EUTMR](#) either.

Case No	Comment
08/06/2010 <a href="#">B 1 461 948</a> , Quick Effect Plaster Gu Tong Tie Gao (fig.)	As <a href="#">Article 8(3) EUTMR</a> refers only to earlier trade marks, the evidence filed by the opponent with regard to rights in respect of copyright law in the territory of China was not relevant. This is another kind of intellectual property right that is excluded as a result of the express reference in the article to ‘trade marks’.

It is clear from the wording of [Article 8\(3\) EUTMR](#) that the trade mark on which the opposition is based must be **earlier** than the EUTM application. Hence, the **relevant point in time** that should be taken into account is the **filing or priority date** of the contested application. The rules according to which the priority should be determined depend on the kind of trade mark relied upon. If the earlier mark has been acquired by registration, it is its filing or priority date that should be taken into account for assessing whether it precedes the contested EUTM application, whereas if it is a use-based right, the relevant conditions for protection through use must have been fulfilled before the filing date (or if appropriate, the priority date) of the contested EUTM application. In the case of earlier well-known marks, the mark must have become well known before the filing or priority date of the contested EUTM application.

Case No	Comment
21/12/2009, <a href="#">R 1621/2006-4</a> , D-Raintank	The Board noted that the trade mark applications filed by the cancellation applicant in 2003 were all later than the filing date of the contested EUTM and even later than its date of registration, and could not serve to establish that the cancellation applicant owned a 'mark' in the sense of a registered mark, be it anywhere in the world, for the sign at issue when the EUTM was filed. It went on to affirm that, 'Obviously, nobody can base a claim on relative grounds for refusal or declaration of invalidity on rights which are younger than the contested EUTM' (para. 53).
19/06/1999, <a href="#">B 3 436</a> , NORAXON	The period to be taken into account in order to determine the applicability of <a href="#">Article 8(3) EUTMR</a> starts on the date on which the EUTM application in question came into force, i.e. 26/10/1995. This was the <b>priority date</b> in Germany, claimed by the applicant, granted by the Office and subsequently published, and not the filing date of the EUTM application at the Office.

### 3.2 Origin of the earlier mark

As [Article 8\(2\) EUTMR](#) does not apply to oppositions based on [Article 8\(3\) EUTMR](#), it cannot serve to define the territorial extent of protection granted by [Article 8\(3\) EUTMR](#). In the absence of any other reference in [Article 8\(3\) EUTMR](#) to a 'relevant territory', it is **immaterial whether the earlier trade mark rights reside in the European Union or not**.

The practical importance of this provision lies precisely in the legal capacity it confers on holders of trade mark rights **outside the European Union** to defend these rights against fraudulent filings, since proprietors of trade mark rights within the European Union may rely on the other grounds provided for in [Article 8 EUTMR](#) to defend their earlier rights from such acts. Of course, EUTMs or national marks, which provide a basis for opposition pursuant to [Article 8 EUTMR](#), also qualify as earlier marks that can be invoked as a basis for an [Article 8\(3\) EUTMR](#) opposition.



Case No	Comment
<p>19/12/2006,  <a href="#">B 715 146</a>, Squirt</p>	<p>‘For the purpose of <a href="#">Article 8(3) EUTMR</a>, it is immaterial where in the world the rights of proprietorship reside. Indeed, if in the Paris Convention <b>the proprietorship in a Paris Union member country</b> is required, in the absence of any reference in the EUTMR to any territory in which such proprietorship shall exist, one must conclude that it is sufficient that the opponent complies with the requirements of <a href="#">Article 5 EUTMR</a> concerning “Persons who can be proprietors of European Union trade marks”. In the present case, the opponent complied with such a requirement, as it was a company based in the United States of America.’</p>
<p>10/01/2011,  <a href="#">3 253 C</a>, MUSASHI (fig.)</p>	<p>The fact that the earlier registrations were from non-EU countries has no bearing on the invalidity ground at issue, since <a href="#">Article 8(2) EUTMR</a>, imposing this territorial condition, does not apply to proceedings based on <a href="#">Article 8(3) EUTMR</a> and cannot serve to define the territorial extent of protection granted by that article. ‘In the absence of any reference to a “relevant territory” in <a href="#">Article 8(3) EUTMR</a>, the Cancellation Division must presume that earlier trade marks registered in countries outside the EU may constitute the basis for an invalidity request based on <a href="#">Article 8(3) EUTMR</a> (para. 33).’</p>
<p>26/01/2012, <a href="#">R 1956/2010-1</a>, HEATSTRIP / HEATSTRIP          (confirmed 09/07/2014, <a href="#">T-184/12</a>)</p>	<p>The opposition was based on an unregistered mark protected, inter alia, in Australia. The Board considered that the evidence submitted by the opponent supports that it has been using the mark in Australia to a substantial extent (paras 3 and 34 respectively).</p>
<p>19/05/2011, <a href="#">R 85/2010-4</a>, LINGHAMS’S (fig.) / LINGHAMS’S (fig.)</p>	<p>The opposition was based on a registered mark protected in Malaysia. By filing the Malaysian registration certificate, it was proven that the opponent is the owner of the Malaysian trade mark.</p>

## 4 Conditions of Application

[Article 8\(3\) EUTMR](#) entitles trade mark proprietors to oppose the registration of their marks as EUTMs, provided the following substantive cumulative requirements are met (13/04/2011, [T-262/09](#), First Defense Aerosol Pepper Projector, EU:T:2011:171, § 61).

1. The applicant is or was an agent or representative of the proprietor of the mark.
2. The application is in the name of the agent or representative.
3. The application was filed without the proprietor's consent.
4. The agent or representative fails to justify its acts.
5. The signs and the goods and services are identical or closely related.

### 4.1 Agent or representative relationship

#### 4.1.1 Nature of the relationship

In view of the purpose of this provision, which is to safeguard the legal interests of trade mark proprietors against the misappropriation of their trade marks by their commercial associates, the terms 'agent' and 'representative' should be **interpreted broadly** to cover all kinds of relationships based on any business arrangement (governed by a written or oral contract) where one party is representing the interests of another, regardless of the *nomen juris* of the contractual relationship between the principal-proprietor and the EUTM applicant. It is sufficient for the purposes of [Article 8\(3\) EUTMR](#) that there is some agreement of commercial cooperation between the parties of a kind that gives rise to a **fiduciary relationship** by imposing on the applicant, whether expressly or implicitly, a general duty of **trust and loyalty** as regards the interests of the trade mark proprietor (11/11/2020, [C-809/18 P](#), MINERAL MAGIC, EU:C:2020:902, § 84-85).

It follows that [Article 8\(3\) EUTMR](#) may also extend, for example, to licensees of the proprietor, or to authorised distributors of the goods for which the mark in question is used.

Case No	Comment
---------	---------

<p>11/11/2020, <a href="#">C-809/18 P</a>, MINERAL MAGIC</p>	<p>The applicant could be regarded as an ‘agent’ of the proprietor of the earlier mark in light of the distribution agreement between the parties. According to the agreement, the proprietor would supply the goods under the earlier mark to the applicant and the latter would be responsible for distributing the proprietor’s goods within the EU and worldwide. The agreement also indicated the applicant as a preferred distributor of the proprietor’s goods, and included a non-competition clause and provisions relating to the proprietor’s intellectual property rights with respect to those goods (paras 86-87).</p>
<p>09/07/2014, <a href="#">T-184/12</a>, Heatstrip</p>	<p>Although there was no written cooperation agreement between the parties, their relationship on the date of the application for the EUTM was, in view of the business correspondence between them, more than that of merely buyer and seller. There was, rather, a tacit cooperation agreement that led to a fiduciary obligation on the part of the EUTM applicant (para. 67).</p>
<p>21/11/2014, <a href="#">R 1958/2013-1</a>, СЛОБОДА (fig.)</p>	<p>The contents of the exchanged information show that the consted mark’s proprietor was, in effect, acting as an agent or distributor for the invalidity applicant. Even if the relationship was not explicitly defined as such, the parties appeared to be business partners, which would require a certain level of trust. The contested mark’s proprietor was regularly reporting on and consulting about the marketing strategy with the invalidity applicant, which allowed its agent a certain level of control (para. 46).</p>

Given the variety of forms that commercial relationships may acquire in practice, a **case-by-case approach** is applied, focusing on whether the contractual link between the proprietor-opponent and the applicant is only limited to a series of occasional transactions, or if, conversely, it is of such a duration and content to justify the application of [Article 8\(3\) EUTMR](#) (as regards the points in time that are crucial for the relationship, see, [paragraph 4.1.4](#) ). The material question should be whether it was the cooperation with the proprietor that allowed the applicant to get to know and appreciate the value of the mark and incited the applicant to subsequently try to register the mark in their own name.

Nevertheless, some kind of cooperation agreement has to exist between the parties. If the applicant acts completely **independently**, without having entered into any kind of fiduciary relationship with the proprietor, the applicant cannot be considered an agent within the meaning of [Article 8\(3\) EUTMR](#) (confirmed 13/04/2011, [T-262/09](#), First Defense Aerosol Pepper Projector, EU:T:2011:171, § 64).

Case No	Comment
16/06/2011, 4 103 C, RETROFIT	The parties held parallel and independent rights to the marks in the USA and Japan at the time of filing the contested mark. An agent or representative relationship was not proved.

Case No	Comment
17/03/2000, <a href="#">B 26 759</a> , EAST SIDE MARIO'S	A mere desire to establish a commercial relationship with the opponent cannot be considered as a concluded agreement between the parties regarding the use of the contested trade mark.

Therefore, **a mere customer or a client** of the proprietor cannot amount to an 'agent or representative' for the purposes of [Article 8\(3\) EUTMR](#), since such persons are under no special obligation of trust to the trade mark proprietor.

Case No	Comment
13/04/2011, <a href="#">T-262/09</a> , First Defense Aerosol Pepper Projector	The evidence did not show that the applicant acted on behalf of the opponent, but merely that there was a seller-customer relationship. Such a relationship is not sufficient for <a href="#">Article 8(3) EUTMR</a> to be applicable (para. 67).
26/06/2009, <a href="#">B 955 528</a> , Iber Fusion (fig.)	It could not be established on the basis of the evidence submitted whether the applicant was really an agent or representative or a mere purchaser of the opponent's goods.

It is irrelevant for the purposes of [Article 8\(3\) EUTMR](#) whether an **exclusive** agreement exists between the parties, or just a simple, non-exclusive commercial relationship. Indeed, a commercial cooperation agreement entailing an obligation of loyalty can exist even in the absence of an exclusivity clause (09/07/2014, [T-184/12](#), Heatstrip, EU:T:2014:621, § 69).

[Article 8\(3\) EUTMR](#) also applies to **analogous** forms of business relationships that give rise to an obligation of trust and confidentiality between the trade mark proprietor and the professional, as is the case with legal practitioners and attorneys, consultants, trade mark agents, etc. However, the legal representative or manager of the opponent's company cannot be considered as an agent or representative within the meaning of [Article 8\(3\) EUTMR](#), given that such persons are not business associates of the opponent. The purpose of this provision is not to protect the proprietor from infringing acts coming from within their company. It may well be that such acts can be sanctioned under the general bad faith provision in [Article 59\(1\)\(b\) EUTMR](#).

Case No	Comment
20/03/2000, <a href="#">B 126 633</a> , Harpoon (fig.)	The applicant was a legal representative of the opponent's company which was insufficient to prove the required relationship under <a href="#">Article 8(3) EUTMR</a> .

The **burden of proof** regarding the existence of a cooperation relationship lies with the opponent (13/04/2011, [T-262/09](#), First Defense Aerosol Pepper Projector, EU:T:2011:171, § 64, 67).

#### 4.1.2 Form of the agreement

It is not necessary for the agreement between the parties to assume the form of a written contract. Of course, the existence of a formal agreement between the parties will be of great value in determining exactly what kind of relationship exists between them. As mentioned above, the title of such an agreement and the terminology chosen by the parties should not be taken as conclusive. What counts is the kind of commercial cooperation established in substance and not its formal description.

Even in cases where a written contract does not exist, it may still be possible to infer the existence of a commercial agreement of the kind required by [Article 8\(3\) EUTMR](#) by reference to indirect indications and evidence, such as the commercial correspondence between the parties, invoices and purchase orders for goods sold to the agent, or credit notes and other banking instruments (always bearing in mind that a mere customer relationship is insufficient for [Article 8\(3\) EUTMR](#)). Even dispute resolution agreements may be relevant to the extent that they give sufficient information about the past relationship between the parties.

Case No	Comment
---------	---------

<p>07/07/2003,  <a href="#">R 336/2001-2</a>,                  GORDON SMITH (fig.) / GORDON &amp; SMITH</p>	<p>The Opposition Division was correct to conclude that there was an agency relationship between the applicant and the opponents, on the basis of correspondence indicating that the two parties had a long and close commercial relationship. The applicant company acted as a distributor of the opponents' goods (para. 18).</p>
---	---

Furthermore, circumstances such as sales targets imposed on the applicant, or payment of royalties, or production of the goods covered by the mark under licence or help in the setting up of a local distribution network, will be strong indications of a commercial relationship of the type covered by [Article 8\(3\) EUTMR](#).

The Court also decided that active cooperation between an EUTM applicant and an opponent in the advertising of the product, in order to optimise the marketing thereof, could give rise to the fiduciary relationship required under [Article 8\(3\) EUTMR](#).

Case No	Comment
---------	---------

<p>26/01/2012,  <a href="#">R 1956/2010-1</a>,                  HEATSTRIP / HEATSTRIP                  (confirmed 09/07/2014, <a href="#">T-184/12</a>)</p>	<p>The Court confirmed the findings of the Board, who considered that a binding contractual relationship could be established by means of <b>business letters exchanged</b> by the parties, including by email. The Board examined the email correspondence between the parties to determine what each party asked from the other (para. 50). The Board concluded that the emails showed that both parties were actively cooperating in the promotion of the product, by advertising it in brochures and exhibiting it at a fair, in order to create the best conditions for its successful marketing: the opponent supplied the material for these purposes and the applicant adapted it to the German market (para. 54). The Board thus concluded that the email correspondence denoted an agreement of commercial cooperation between the parties of a kind that gives rise to a fiduciary relationship (para. 56). The Court dismissed the applicant's arguments that there was no cooperation between the parties (because the applicant was not integrated in the opponent's sales structure, was not subject to a no-competition clause and had to bear the costs of sale and promotion) and confirmed the Board's decision (para. 67 et seq.).</p>
---	--

However, the mere desire of the applicant to enter into a commercial relationship with the opponent cannot be considered as a concluded agreement between the parties. Prospective agents or representatives are not covered by [Article 8\(3\) EUTMR](#) (see B 26 759 cited above).

#### 4.1.3 Territorial scope of the agreement

Neither [Article 8\(3\) EUTMR](#) nor Article 6*septies* of the Paris Convention explicitly refer to the territorial scope of the agreement between the principal and its agent. As the purpose of the provision is to guard against the breach of trust that the original proprietor has put in its agent, it would appear that the territorial scope of their agreement should not limit the application of that provision. The agent's general duty of trust and loyalty as regards the interests of the legitimate proprietor of the mark cannot be limited territorially. In the context of a globalised and integrated economy, the proprietor should reasonably expect to be able to expand into new markets without running into registrations made by the agents it has in its existing markets (14/09/2004, [R 460/2003-2](#), CELLFOOD / CELLFOOD, § 17-18).

Therefore, even if the agreement between the agent and the principal concerned only a territory outside the European Union, [Article 8\(3\) EUTMR](#) may still apply.

#### 4.1.4 Relevant points in time

The agent-representative relationship must have been established **prior to the filing date** of the EUTM application. Therefore, it is immaterial whether after that time the applicant entered negotiations with the opponent, or made unilateral proposals with the purpose of becoming a representative or agent of the latter.

Case No	Comment
19/05/2011, <a href="#">R 85/2010-4</a> , LINGHAMS'S (fig.) / LINGHAMS'S (fig.)	The opponent granted the applicant a special power of attorney (PoA), consenting to the applicant's filing of trade mark applications. Subsequent to this PoA, the applicant filed an EUTM. After the filing, the opponent revoked the PoA and filed the opposition.  The Board considered that the relevant point in time is the filing date. At that moment, the owner's consent was present. The revocation had effects <i>ex nunc</i> (and does not affect the validity of actions performed under the PoA) and not <i>ex tunc</i> (as if the PoA had never existed) (para. 24).
06/09/2006, <a href="#">T-6/05</a> , First Defense Aerosol Pepper Projector	The Board of Appeal ought to have examined whether, on the day of the application for registration of the mark, the intervener was still bound by the consent (para. 50).

However, even if the agreement between the parties was formally concluded **after the filing date** of the application, it may still be possible to deduce from the evidence that the parties were already in some form of commercial cooperation before the signature of the relevant contract and that the applicant was already acting as the opponent's agent, representative, distributor or licensee.

However, the agreement between the parties **does not have to be still in force technically** when the application is filed. The reference to a filing made by an 'agent or representative' should not be understood as a formal requirement that must be present at the time the EUTM application is filed. [Article 8\(3\) EUTMR](#) also applies to **agreements that expired before the filing date of the EUTM application**, provided that the time that has lapsed is of such duration that it can be reasonably assumed that the obligation of trust and confidentiality was still present when the EUTM application was filed (confirmed 13/04/2011, [T-262/09](#), First Defense Aerosol Pepper Projector, EU:T:2011:171, § 65).



[Article 8\(3\) EUTMR](#) and Article 6*septies* PC do not protect a trade mark proprietor that is careless and makes no efforts to secure trade mark protection on its own. Post-contractual fiduciary obligations mean that none of the parties may use the termination of an agreement as a pretext for getting rid of its obligations, for example, by terminating an agreement and immediately afterwards filing a trade mark. The rationale of [Article 8\(3\) EUTMR](#) and Article 6*septies* PC is to prevent a situation where a representative in country A of a principal who owns trade marks in country B, and who is meant to market the trade-marked goods and observe the interests of the latter in country A, uses the filing of a trade mark application in country A as a weapon against the principal, for example to force the principal to continue with the representative and to prevent the principal from entering the market in country A. This rationale likewise applies if an agreement exists but the representative terminates it to take advantage and file a trade mark for the same reasons. However, this does not create absolute rights for the principal to obtain trade mark protection in other countries. The mere fact that the principal holds a trade mark in country B does not give the principal an absolute right to obtain trade marks in all other countries; the trade marks registered in different countries are in principle independent from each other and may have different proprietors, in accordance with Article 6(3) PC. Article 6*septies* PC is an exception to this principle and only to the extent that the contractual or de facto obligations of the parties involved justify this. Only to that extent is it justified that the ensuing EUTM would 'belong' to the principal under Article 21 EUTMR (19/11/2007, [R 73/2006-4](#), PORTER (fig.) / PORTER (fig.) et al., § 26).

This should be assessed on a case-by-case basis, and the decisive factor should be whether it is still possible for the applicant to take commercial advantage of its expired relationship with the trade mark proprietor by exploiting the know-how and contacts it acquired because of its position.

Case No	Comment
19/11/2007, <a href="#">R 73/2006-4</a> , PORTER (fig.) / PORTER (fig.) et al.	The contested application was not filed during the validity of the agreements between the parties, which allowed the applicant to file an EUTM, but nearly <b>1 year</b> after the termination of the last agreement (para. 25). Post-contractual fiduciary obligations are not meant to last forever but for a certain transitional period after the termination of the agreement in which the parties may redefine their commercial strategies. Any post-contractual relationship between the parties was phased out by the time of the filing of the contested mark (para. 27).

Case No	Comment
21/02/2002, <a href="#">B 167 926</a> , AZONIC	Less than <b>3 months</b> after the expiry of a contract relationship such as a licence agreement, the fiduciary relationship between the parties still exists imposing on the applicant a duty of loyalty and confidence.

## 4.2 Application in the agent's name

According to [Article 8\(3\) EUTMR](#), the trade mark applied for will not be registered where the agent or representative applies for registration thereof in its own name. It will usually be easy to assess whether this requirement has been fulfilled, by comparing the name of the applicant with that of the person appearing in the evidence as the agent or representative of the proprietor.

However, there may be cases where the agent or representative will try to **circumvent** this provision by arranging for the application to be filed by a third person, whom it either controls, or with whom it has entered into some form of understanding to that effect. In such cases adopting a more flexible approach is justified. Therefore, if it is clear that because of the nature of the relationship between the person filing the application and the agent, the situation is effectively the same as if the application had been filed by the agent personally, it is still possible to apply [Article 8\(3\) EUTMR](#), notwithstanding the apparent discrepancy between the applicant's name and the name of the proprietor's agent.

Such a case could arise if the application is filed not in the name of the agent's company, but in the name of a natural person that **shares the same economic interests** as the agent, as for example its president, vice-president or legal representative. Given that in this case the agent or representative could still benefit from such a filing, it should be considered that the natural person is bound by the same limitations as the company.

Case No	Comment
21/02/2002, <a href="#">B 167 926</a> , AZONIC	The Opposition Division considered that, even though the EUTM application was applied for in the name of the natural person Mr Costahaude instead of directly in the name of the legal person STYLE'N USA, INC., the situation was effectively the same as if it had been filed in the name of the legal person.

Case No	Comment
28/05/2003, <a href="#">B 413 890</a> , CELLFOOD	If it is clear that because of the nature of the relationship between the person filing the application and the agent, the situation is effectively the same as if the application had been filed by the agent personally, it is still possible to apply <a href="#">Article 8(3) EUTMR</a> , notwithstanding the apparent discrepancy between the applicant's name and the name of the owner's agent.

Moreover, if the person filing the contested application had also **signed the agency agreement** on behalf of the company, this would have to be considered a strong argument in favour of the application of [Article 8\(3\) EUTMR](#), since in such a case the applicant cannot possibly deny direct knowledge of the relevant prohibitions. Similarly, if an agency agreement contained a **clause** holding the management of the company personally responsible for the observance of the contractual obligations undertaken by the agent, this would also have to be considered a further indication that the filing of the application is covered by the prohibition of [Article 8\(3\) EUTMR](#).

Case No	Comment

<p>21/02/2002, <a href="#">B 167 926</a>, AZONIC</p>	<p>Bearing in mind the position of the authorised representative of the licensee company, the Office considered that despite the fact that the EUTM application was made in the name of this natural person, the situation was effectively the same as if it had been filed by the legal person, that is, the licensee company. The EUTM application in the name of the former could have a direct effect on the latter due to their professional relationship, and, furthermore, the president or vice-president of a company should be considered obliged by the same limitations as their company, or at least temporarily obliged in the case of the expiry of their professional relationship.</p> <p>This position is strengthened by the fact that in the present case there is a clause in the renewed agreement that establishes the licensor's immediate termination right in the case that '... control of STYLE'N (the licensee) is transferred and the management thereby changed', which shows that the management of the licensee company was also bound by the terms of the agreement.</p>
--	--

A similar case arises where the agent or the representative and the applicant are distinct legal entities, but the evidence shows that they are **controlled, managed or run** by the same natural person. For the reasons given above it is appropriate to 'lift the corporate veil' and apply [Article 8\(3\) EUTMR](#) also to these cases.

### 4.3 Application without the proprietor's consent

Even though the absence of the proprietor's consent is a **necessary condition** for the application of [Article 8\(3\) EUTMR](#), the **opponent does not have to submit evidence that shows that the agent was not permitted** to file the EUTM application. A mere **statement** that the filing was made without its consent is generally **sufficient**. This is because the opponent cannot be expected to prove a 'negative' fact, such as the **absence** of consent. In these cases the **burden of proof is reversed** and it is up to the applicant to prove that the filing was authorised, or to give some other justification for its acts.

In view of the need to provide effective protection to the legitimate proprietor from unauthorised acts of its agents, the application of [Article 8\(3\) EUTMR](#) should be denied only where the proprietor's consent is sufficiently **clear, specific and unconditional** (06/09/2006, [T-6/05](#), First Defense Aerosol Pepper Projector, EU:T:2006:241, § 40).

Therefore, even if the proprietor has expressly authorised the filing of the EUTM application, its consent cannot be considered sufficiently clear if it has not also explicitly specified that the application may be in the name of the agent.

Case No	Comment
07/07/2003, <a href="#">R 336/2001-2</a> , GORDON SMITH (fig.) / GORDON & SMITH	'In view of its serious effect in extinguishing the exclusive rights of the proprietors of the trade marks in issue in the main proceedings (rights which enable them to control the initial marketing in the EEA), consent must be so expressed that an intention to renounce those rights is unequivocally demonstrated' (para. 18).

Likewise, even if the proprietor has expressly authorised the filing of an EUTM application, its consent cannot be considered sufficiently specific for the purposes of [Article 8\(3\) EUTMR](#) if there is no indication of the specific signs for which the applicant has permission to file as an EUTM.

It will be generally easier to assess whether the filing was authorised by the proprietor where the conditions under which an agent or representative may apply for an EUTM application are adequately regulated by **contract**, or are given by other kinds of **direct evidence** (letters, written representations, etc.). In most cases, such evidence will be sufficient to demonstrate whether the proprietor has given its express consent, or if the applicant has exceeded the limits of its authorisation.

In other cases, a contract will either not exist or it will be inadequate on the subject. Although the wording of [Article 8\(3\) EUTMR](#) is in principle broad enough to include cases of **tacit or implied consent**, such consent should only be inferred if the evidence is sufficiently clear as to the intentions of the proprietor. If the **evidence is completely silent** as to the existence of an express or implied authorisation, **lack of consent should be generally presumed**.

Notwithstanding **indirect indications** and evidence pointing to implied consent, any **ambiguity or doubt** should be **interpreted in favour of the opponent**, as it will usually be quite difficult to assess whether such consent is sufficiently clear and unequivocal.

For example, the mere fact that the proprietor tolerated unauthorised applications in the name of the agent in third jurisdictions cannot alone create legitimate expectations on the part of the applicant that the proprietor will not object to the filing of an EUTM application either.

Case No	Comment
---------	---------

<p>31/01/2001, <a href="#">B 140 006</a>, GORDON SMITH (fig.); confirmed 07/07/2003, <a href="#">R 336/2001-2</a>, GORDON SMITH (fig.) / GORDON &amp; SMITH</p>	<p>The mere fact that the opponents failed to immediately oppose the applicant's action to register the trade mark after they received notice of the fact did not constitute consent.</p>
---	---

The fact that the proprietor tolerates conduct outside the boundaries of a contract (such as use of the sign) cannot lead to the conclusion that filing the EUTM did not breach the established fiduciary duty if consent is not clear, specific and unconditional.

Case No	Comment
<p><a href="#">T-537/10</a> &amp; <a href="#">T-538/10</a>, Fagumit, EU:T:2012:2952,</p>	<p>The applicant (the EUTM owner in cancellation proceedings) focused her line of argument on the consent allegedly granted by the proprietor of the mark. The Court held (like the Board of Appeal) that the consent for the purposes of the registration of the mark in the name of the representative or agent must be clear, specific and unconditional (paras 20-23).</p> <p>The document relied upon by the EUTM owner does not show consent within the meaning of <a href="#">Article 8(3) EUTMR</a> (para. 28). The EUTM owner was not mentioned in the document and it did not refer to the possibility of registration of the sign as a trade mark. The EUTM owner cannot rely on the fact that the cancellation applicant did not object to the use of the sign by companies other than those referred to in the document. Use of the marks occurred during the course of marketing the goods produced by the cancellation applicant. However, such use is the logical consequence of the cooperation between the cancellation applicant and the distributors of its goods and does not show any abandonment of the sign, which would enable anyone to make an application for the registration of that sign — or its dominant element — as an EUTM (para. 27)</p>

Even where consent of the proprietor has been deemed to be clear, specific and unconditional, it will be a question of fact to determine if such consent survives a **change of proprietor** by way of an asset sale.

Case No	Comment
06/09/2006, <a href="#">T-6/05</a> , First Defense Aerosol Pepper Projector	<p>The General Court remitted a case of this nature back to the Boards of Appeal in order to determine whether the consent obtained by the EUTM applicant had survived the purchase of the assets of the former trade mark holder and whether, on the day of the application for registration of the mark, the new holder of the trade mark in the USA (the opponent) was <b>still bound</b> by that consent.</p> <p>If the opponent was no longer bound by the consent, the General Court indicated that the Board ought then to determine whether the applicant had a <b>valid justification</b> which could offset the lack of such consent.</p>

#### 4.4 Absence of justification on the part of the applicant

As mentioned above, since it is not possible for the opponent to prove the absence of consent, the burden of proof is reversed and it is up to the applicant to show that the filing of the application was authorised by the proprietor. Although [Article 8\(3\) EUTMR](#) treats the lack of the proprietor's consent and the absence of a valid justification on the part of the applicant as two separate conditions, these requirements largely overlap to the extent that if the applicant establishes that the filing of the application was based on some agreement or understanding to this effect, then it will also have provided a valid justification for its acts.

In addition, the applicant may invoke any other kind of circumstance showing that it had a justification for filing the EUTM application in its own name. However, in the absence of evidence of direct consent, only exceptional reasons are accepted as valid justifications, in view of the need to avoid a violation of the proprietor's legitimate interests without sufficient indications that its intention was to allow the agent to file the application in its own name.

For example, it could be possible to infer that the proprietor has tacitly consented to the filing of the application if it does not react within a reasonable period of time after having been informed by the applicant that it intends to apply for an EUTM in its own name. However, even in such a case it will not be possible to assume that the application has been authorised by the proprietor if the agent had not made it sufficiently clear to the proprietor in advance in whose name it would file the application.

Another case of valid justification could be if the proprietor causes its agent to believe that it has abandoned the mark, or that it is not interested in obtaining or maintaining

any rights in the territory concerned, for example, by suspending the use of the mark over a relatively long period of time.

The fact that the proprietor does not want to spend money on registering its trade mark does not give the agent a right to act on its own initiative, as the proprietor might still have an interest in using its trade mark in the territory although it is not registered. Such a business decision cannot be taken in itself as a sign that the proprietor has given up the rights in its mark.

Justifications exclusively linked to an applicant's economic interests, such as the need to protect its investment in setting up a local distribution network and promoting the mark in the relevant territory, cannot be considered valid for the purposes of [Article 8\(3\) EUTMR](#).

Nor can the applicant successfully argue in its defence that it is entitled to some financial remuneration for its efforts and expenditure in building up goodwill for the mark. Even if such remuneration were well deserved or is expressly stipulated in the agency agreement, the applicant cannot use the registration of the mark in its own name as a means of extracting money from the opponent or in lieu of financial compensation, but should try to settle its dispute with the proprietor either by way of agreement or by suing for damages.

Finally, if the applicant does not provide any justification for its actions, it is not for the Office to make any speculations in that regard (09/07/2014, [T-184/12](#), Heatstrip, EU:T:2014:621, § 73-74).

Case No	Comment
<p>04/10/2011, <a href="#">4 443 C</a>, CELLO</p>	<p>As to the justificatory argument that the EUTM application was filed in order to protect the goodwill of the mark in the EU, which had been established solely as a result of its trading activities, the Cancellation Division considered that the fact that a distributor, exclusive or otherwise, develops the goodwill of the trade mark of the owner in its allocated territory forms part of the usual duties of a distributor and cannot constitute, in itself and in the absence of other circumstances, a valid justification for the appropriation of the owner's mark by the distributor.</p>



Case No	Comment
<p>10/01/2011,  <a href="#">3 253 C</a>, MUSASHI (fig.)</p>	<p>As regards justification concerning economic claims of the party filing the EUTM and its arguments that it is entitled to some financial remuneration for permitting the sign to enjoy protection at EU level, and that it could be transferred to the cancellation applicant, it was held that this could not be valid justification within the meaning of <a href="#">Article 8(3) EUTMR</a>. 'Even if remuneration were well deserved, the EUTM proprietor cannot use the registration of a mark in its own name as a means of receiving payment' (from the cancellation applicant) (para. 47).</p>
<p>07/07/2003,  <a href="#">R 336/2001-2</a>, GORDON SMITH (fig.) / GORDON &amp; SMITH</p>	<p>An act which compromises the interests of the trade mark proprietor, such as the filing of a trade mark application in the agent's or a representative's name without the proprietor's consent, and is driven solely by an intention to safeguard the agent's or a representative's own interests, is not considered justifiable for the purposes of <a href="#">Article 8(3) EUTMR</a>. The same applies to the applicant's second argument, that is, that it was justified in doing so because it bore the registration costs. The interests of the trade mark proprietor cannot be subordinate to an agent's or a representative's financial expenses. The fact that an opponent might be unwilling to incur any financial expenses to register a trade mark does not automatically grant a right to the agent or representative to proceed with the registration of the trade mark in its own name. This would constitute a violation of the agent's or representative's duty of trust and loyalty towards the trade mark proprietor (para. 24).</p>

#### 4.5 Relationship between the marks and between the goods and services

#### 4.5.1 Protection beyond identical marks and identical goods and services

[Article 8\(3\) EUTMR](#) provides that an EUTM application will not be registered where an agent or representative of the proprietor of **the mark** applies for registration **thereof** in their own name. Such an explicit reference to the principal's trade mark gives the prima facie impression that the EUTM applied for must be the same as the earlier mark.

A literal interpretation of [Article 8\(3\) EUTMR](#) would lead to the conclusion that its application is only possible where the agent or representative intends to register a mark **identical** to that of the proprietor.

Moreover, the text of [Article 8\(3\) EUTMR](#) does not refer to the goods and services for which the application has been filed and for which the earlier mark is protected. Thus, it gives no guidance on what the exact relationship between the respective goods and services should be for the provision to apply.

A **dissimilarity** of the marks or the goods and services precludes the application of [Article 8\(3\) EUTMR](#) as in those cases the contested mark could not be attributed to the original proprietor.

However, applying [Article 8\(3\) EUTMR](#) exclusively to identical marks for identical goods or services would render this provision largely ineffective, as it would allow the applicant to make variations either to the earlier mark or to the specification of goods and services that would still allow the contested mark to be attributed to the original proprietor.

Therefore, the scope of application of [Article 8\(3\) EUTMR](#) should not be limited to identical marks but should also extend to **similar marks** (11/11/2020, [C-809/18 P](#), MINERAL MAGIC, EU:C:2020:902, § 74, 91 and 99). Likewise, its application cannot be precluded just because the **goods or services are similar**, and not identical (11/11/2020, [C-809/18 P](#), MINERAL MAGIC, EU:C:2020:902, § 99).



However, the assessment of similarity for the purposes of [Article 8\(3\) EUTMR](#) must be made in due consideration of the objective pursued by that provision, which is to prevent the misappropriation of the earlier mark by the agent or representative of the proprietor of that mark.



Moreover, not just any degree of similarity between the marks and the goods or services at issue may entail a misappropriation of the earlier mark. In particular, **likelihood of confusion is not a condition** for the application of [Article 8\(3\) EUTMR](#) (11/11/2020, [C-809/18 P](#), MINERAL MAGIC, EU:C:2020:902, § 92). The **degree of similarity** between the marks and the goods or services should be such so as to guarantee that the purpose of [Article 8\(3\) EUTMR](#) is met, namely to prevent the misappropriation of the mark by the proprietor's agent (11/11/2020, [C-809/18 P](#), MINERAL MAGIC, EU:C:2020:902, § 72).

## 4.5.2 Relationship between the marks



It must be verified that the contested mark is sufficiently close to the earlier mark that, despite any variations, it would still be attributed to the original proprietor. Variations to the earlier mark which do not affect its original distinctiveness are not sufficient to exclude the application of [Article 8\(3\) EUTMR](#). On the other hand, where the contested mark contains variations that alter the original distinctiveness of the earlier mark, it would be, in principle, more unlikely to find that there was misappropriation.

The following are examples of **non-identical marks** considered to fall under [Article 8\(3\) EUTMR](#).

Earlier mark	Contested mark	Case No
		03/05/2012, <a href="#">R 1642/2011-2</a>
<p>G&amp;S: Classes 11, 19, 20, 37, 42</p> <p><i>Territory of protection of earlier mark:</i> Norway</p> <p><i>Assessment:</i> The figurative element of the earlier trade mark is entirely reproduced in the contested mark; the marks are visually, aurally and conceptually highly similar. The presence of the word 'acopafi' in the contested mark cannot disqualify it from the application of <a href="#">Article 8(3) EUTMR</a> (para. 18).</p>		

Earlier mark	Contested mark	Case No
(i) BERIK (ii) 		03/08/2010, <a href="#">R 1367/2009-2</a>
<p>G&amp;S: Classes 18, 25</p> <p><i>Territory of protection of earlier mark:</i> EU</p> <p><i>Assessment:</i> In as much as the contested mark reproduces the earlier marks in a combined form, the marks are sufficiently close to justify the application of <a href="#">Article 8(3) EUTMR</a> (para. 32).</p>		

Earlier mark	Contested mark	Case No
--------------	----------------	---------

<p>(i) BERIK</p> <p>(ii)</p> 		<p>03/08/2010, <a href="#">R 1231/2009-2</a></p>
<p>G&amp;S: Classes 16, 25</p> <p><i>Territory of protection of earlier mark:</i> EU</p> <p><i>Assessment:</i> In as much as the contested mark reproduces the earlier marks in a combined form, the marks are sufficiently close to justify the application of <a href="#">Article 8(3) EUTMR</a> (para. 30).</p>		



#### 4.5.3 Relationship between the goods and services

It must be verified whether the goods and services display a close relationship in commercial terms such that the use of the contested mark for those goods or services would pose a serious obstacle for the original proprietor to enter the EU market or continue exploiting its mark on that market.

What counts is that the contested goods or services may be perceived by the public as being provided as a result of an agreement between the parties and that it would be reasonable for the original proprietor to provide such goods or services itself in view of the scope of protection of the earlier mark.

The following are examples of **goods and services that are not identical** but are considered, nevertheless, to fall under [Article 8\(3\) EUTMR](#).

Earlier mark	Contested mark	Case No
SpectraLayers	SpectraLayers	25/05/2020, <a href="#">R 2139/2019-5</a>
<p>G&amp;S: Classes 9, 42</p> <p><i>Territory of protection of earlier mark:</i> United States of America</p> <p><i>Assessment:</i> The contested services in Class 42 (<i>providing software updates via the internet; providing information, advice and consultancy services in the field of computer software; hosting services and software as a service and rental of software</i>) comprise a range of ancillary services to software which are usually rendered in connection with the earlier <i>audio editing software</i> in Class 9. There is a close functional relationship between the goods and services at issue, which must be considered highly similar (para. 48).</p>		

Earlier mark	Contested mark	Case No
		27/03/2017, <a href="#">R 673/2016-2</a>
<p>G&amp;S: Classes 1, 2, 3, 7, 37</p> <p><i>Territory of protection of earlier mark:</i> Japan</p> <p><i>Assessment:</i> <a href="#">Article 8(3) EUTMR</a> applies when the goods and services in conflict are closely related (e.g. complementary), essentially the same or largely equivalent in commercial terms. It must be verified whether the contested goods or services may be perceived by the public as 'authorised' products, the quality of which is somehow 'guaranteed' by the opponent, and which it would have been reasonable for the opponent to market itself in view of the goods and services protected under the earlier mark (para. 52). Although the contested goods in Class 2 are not included in the earlier Japanese mark, they are similar, closely related or commercially equivalent to several of the earlier goods and services in Classes 3, 7 and 37 (para. 75).</p>		

The following are examples of variations in the goods and services, **not** considered to fall under [Article 8\(3\) EUTMR](#).



Earlier mark	Contested mark	Case No
studioline	STUDIOLINE	15/09/2015, <a href="#">R 2406/2014-5</a>
<p>G&amp;S: Classes 35, 41</p> <p><i>Territory of protection of earlier mark:</i> Germany, the Netherlands, Poland, France and Spain</p> <p><i>Assessment:</i> The connection between <i>photographer services</i>, including in the sense of 'organisation of photo-shoot parties', and <i>sporting and cultural activities</i> is too imprecise and vague to be regarded as 'equivalent in commercial terms'. It can be concluded from this that the decision concerned correctly refused the opposition in relation to <i>sporting and cultural activities</i> (para. 18).</p>		

Earlier mark	Contested mark	Case No
(i) BERIK (ii) 		03/08/2010, <a href="#">R 1367/2009-2</a>

G&S: Classes 18, 25

*Territory of protection of earlier mark:* EU

*Assessment:* The items of *clothing* in Class 25 of the earlier marks cannot be considered to be closely related or equivalent in commercial terms to the contested *leather or imitation leather; trunks; umbrellas* in Class 18 (paras 28-31).

Earlier mark	Contested mark	Case No
(i) BERIK (ii) 		03/08/2010, <a href="#">R 1231/2009-2</a>

G&S: Classes 16, 25

*Territory of protection of earlier mark:* EU

*Assessment:* The items of clothing in Class 25 of the earlier marks cannot be considered to be closely related or equivalent in commercial terms to the contested *printed matter; instructional and teaching materials (except apparatus)* in Class 16 (paras 26-29).

#### 4.5.4 Combined assessment

The required degree of similarity between the marks and between the goods or services at issue cannot be defined in advance since otherwise [Article 8\(3\) EUTMR](#) would be deprived of the necessary flexibility to adapt its scope to the different ways that an agent may attempt to misappropriate the original proprietor's mark. The assessment depends on a factual evaluation of the relevant circumstances of each case.

It may be that (i) the marks are not identical but the goods or services at issue are, (ii) the goods or services at issue are not identical but the marks are, or (iii) neither the marks, nor the goods and services at issue are identical.

It follows from the concept of 'distinctiveness' that the assessment of the impact of any variation on the original distinctive character of the earlier mark necessarily entails an assessment **in relation to the goods and services**. Therefore, the comparison of the marks, for the purposes of [Article 8\(3\) EUTMR](#), cannot be done in isolation from the goods and services.

Since the essential question is whether the contested mark can be attributed to the original proprietor, the assessment of the **impact of the variations** on the original

distinctive character of the earlier mark may vary depending on the particular goods and services of the contested mark. For example, if all the contested goods were similar to the same degree to those of the earlier mark, it may still be that the contested mark would be attributed to the original proprietor in relation to some of them only, but not in relation to others due to the different impact of the variations on the original distinctive character of the earlier mark in relation to those other contested goods.

***GUIDELINES FOR EXAMINATION OF  
EUROPEAN UNION TRADE MARKS***

***EUROPEAN UNION  
INTELLECTUAL PROPERTY OFFICE  
(EUIPO)***

***Part C***

***Opposition***

***Section 4***

***Non-registered trade marks and other signs  
used in the course of trade (Article 8(4)  
EUTMR)***



## Table of Contents

<b>1 Introduction.....</b>	<b>1187</b>
<b>2 Structure of Article 8(4) EUTMR.....</b>	<b>1187</b>
<b>3 Conditions of Article 8(4) EUTMR.....</b>	<b>1188</b>
<b>3.1 Entitlement: direct right conferred on the opponent.....</b>	<b>1189</b>
<b>3.2 Types of rights falling under Article 8(4) EUTMR.....</b>	<b>1189</b>
3.2.1 Introduction.....	1189
3.2.2 Non-registered trade marks.....	1190
3.2.3 Other signs used in the course of trade.....	1190
3.2.3.1 Trade names.....	1192
3.2.3.2 Company names.....	1193
3.2.3.3 Domain names.....	1193
3.2.3.4 Titles.....	1193
<b>3.3 Use requirements.....</b>	<b>1194</b>
3.3.1 National standard.....	1194
3.3.2 European standard — use in the course of trade of more than mere local significance.....	1195
3.3.2.1 Use in the course of trade.....	1195
3.3.2.2 Use of more than mere local significance.....	1199
3.3.2.3 Nature of the use.....	1203
<b>3.4 Earlier right.....</b>	<b>1204</b>
<b>3.5 Right to prohibit the use of a subsequent trade mark under the         applicable law.....</b>	<b>1204</b>
3.5.1 The right of prohibiting use.....	1205
3.5.2 Scope of protection.....	1205
<b>4 Proof of the Applicable Law Governing the Sign.....</b>	<b>1206</b>
<b>4.1 The burden of proof.....</b>	<b>1206</b>
<b>4.2 Means of evidence and standard of proof.....</b>	<b>1207</b>
4.2.1 National law.....	1207
4.2.2 European Union law.....	1210

## 1 Introduction

The relationship between the European Union trade mark system and national law is characterised by the **principle of coexistence**. This means that both the European Union trade mark system and the national laws exist and operate side by side. The same sign can be protected by the same proprietor as an EUTM and as a national trade mark in one (or all) of the Member States. The principle of coexistence further implies that the EUTM system actively acknowledges the relevance of national rights and their scope of protection. Where conflicts arise between EUTMs and national trade marks or other national rights, there is no hierarchy determining that one system prevails over the other; instead, these conflicts apply the principle of priority. If the respective requirements are met, earlier national trade marks or other earlier national rights can prevent registration of, or invalidate a later EUTM.

Although [Directive \(EU\) 2015/2436](#) of the European Parliament and of the Council of 16 December 2015 to approximate the laws of the Member States relating to trade marks and the directives that preceded it have harmonised the laws relating to **registered trade marks**, no such harmonisation has taken place on an EU scale with regard to **non-registered trade marks** nor for most **other earlier rights** of a similar nature. These unharmonised rights remain completely governed by national laws. Furthermore, there are rights other than trade marks whose acquisition and/or scope of protection is governed by EU law.

[Article 8\(4\) EUTMR](#) is the ground for opposition against an EUTM application based on an earlier non-registered trade mark or other sign used in the course of trade protected under EU law or the laws of the Member States, subject to the conditions of that provision.

## 2 Structure of Article 8(4) EUTMR

[Article 8\(4\) EUTMR](#) reads:

Upon opposition by the **proprietor of a non-registered trade mark or of another sign used in the course of trade of more than mere local significance**, the trade mark applied for shall not be registered where and to the extent that, pursuant to the Union legislation or the law of the Member State governing that sign:

1. rights to that sign were **acquired prior** to the date of application for registration of the EU trade mark, or the date of the priority claimed for the application for registration of the EU trade mark;
2. that sign confers on its proprietor the **right to prohibit the use of a subsequent trade mark**.

[Article 8\(4\) EUTMR](#) means that in addition to the earlier trade marks specified in [Article 8\(2\) EUTMR](#), non-registered trade marks and other signs protected at EU or Member State level used in the course of trade of more than mere local significance

can be invoked in an opposition provided that such rights confer on their proprietors the right to prohibit the use of a subsequent trade mark.

[Article 8\(4\) EUTMR](#) does not expressly or exhaustively enumerate the particular rights that can be invoked under this provision, but rather outlines a broad spectrum of rights that might serve as a basis for an opposition against an EUTM application. Therefore, [Article 8\(4\) EUTMR](#) can be regarded as a general ‘catch-all provision’ for oppositions based on non-registered trade marks and other signs used in the course of trade.

Nevertheless, the broad scope of earlier rights to be relied upon in opposition proceedings under [Article 8\(4\) EUTMR](#) is subject to a number of restrictive conditions: these rights must confer an entitlement to the proprietor to exercise them, they must be of more than local significance, they must be protected by the applicable law governing them against the use of a subsequent trade mark and the rights must have been acquired prior to the EUTM application under the applicable law governing that sign.

The ‘more than mere local significance’ requirement aims to restrict the number of potential opposing non-registered rights, thus avoiding the risk of a collapse or paralysis of the EUTM system by being flooded with opposing, relatively insignificant rights.

The ‘national protection’ requirement is deemed necessary as the non-registered national rights are not easily identifiable and their protection is not harmonised on an EU level. Consequently, only national law governing the earlier signs may define the scope of their protection.

While the requirements of ‘use in the course of trade’ and ‘use of more than mere local significance’ are to be interpreted in the context of EU law (European standard), national law applies when determining whether a particular right is recognised and protected under the national law, whether its holder is entitled to prohibit the use of a subsequent trade mark, and what conditions need to be met under national law for the right to be successfully exercised.

As a consequence of this dualism, the Office must apply both the relevant provisions of the EUTMR and the national law governing the earlier opposing right. In view of the two-tier examination to be applied under [Article 8\(4\) EUTMR](#), this provision, as the link between EU and national law, displays a somewhat ‘hybrid’ nature.

### **3 Conditions of Article 8(4) EUTMR**

The conditions for successfully invoking [Article 8\(4\) EUTMR](#) are:

1. the opponent must be the proprietor of a non-registered trade mark or of another sign used in the course of trade or a person authorised under the applicable law to exercise such a right (see paragraphs [3.1](#) and [3.2](#) below);
2. use in the course of trade of more than mere local significance (see paragraph [3.3](#) below);
3. acquisition prior to the EUTM application under the applicable law governing that sign (see paragraph [3.4](#) below);

4. right to prohibit the use of a subsequent trade mark under the applicable law governing that sign (see paragraph [3.5](#) below).

### 3.1 Entitlement: direct right conferred on the opponent

The legal systems of the EU Member States provide various means of preventing the use of later marks on the basis of earlier signs used in the course of trade. However, in order to come within the meaning of [Article 8\(4\) EUTMR](#), the earlier right must be vested in a particular **owner** or a precise class of user that has a **quasi-proprietorial interest** over it, in the sense that it can exclude or prevent others from unlawfully using the sign. This is because [Article 8\(4\) EUTMR](#) is a 'relative' ground for opposition and [Article 46\(1\)\(c\) EUTMR](#) provides that oppositions may be filed only by the proprietors of earlier marks or signs referred to in [Article 8\(4\) EUTMR](#) and by persons authorised under the relevant national law to exercise these rights. In other words, only persons having an interest directly recognised by law in initiating proceedings are entitled to file an opposition within the meaning of [Article 8\(4\) EUTMR](#).

For example, in some Member States, the use of a sign may be prohibited if it results in unfair or misleading business practices. In such cases, if the earlier right lacks any 'proprietary quality', it will not fall within [Article 8\(4\) EUTMR](#). It does not matter whether these signs are protected against misleading or unfair use under trade mark law, the law relating to unfair competition, or any other set of provisions.

In assessing the proprietorship of a sign used in the course of trade, the Office must analyse specifically whether the opponent has acquired rights over the sign 'in accordance with the national law' (18/01/2012, [T-304/09](#), BASmALI, EU:T:2012:13).

### 3.2 Types of rights falling under Article 8(4) EUTMR

#### 3.2.1 Introduction

When assessing which kind of intellectual property rights can be invoked under [Article 8\(4\) EUTMR](#) and which cannot, a European standard applies. The distinction follows from the scheme of the EUTMR and, in particular, from the differentiation made between the kinds of earlier signs upon which an opposition may be based under [Article 8\(4\) EUTMR](#) and the types of further rights that may be the basis for invalidity under [Article 60\(2\) EUTMR](#). While [Article 8\(4\) EUTMR](#) refers to **signs** ('non-registered trade mark or ... another sign'), [Article 60\(2\) EUTMR](#) refers to a broader set of rights: (a) a right to a name; (b) a right of personal portrayal; (c) a copyright; and (d) an industrial property right.

Therefore, although the signs covered by [Article 8\(4\) EUTMR](#) fall within the broad category of 'industrial property rights', not all industrial property rights are 'signs' for the purposes of [Article 8\(4\) EUTMR](#). Since this distinction is contained in the EUTMR, the classification of a right under the respective national law is not decisive, and it is

immaterial whether the national law governing the respective sign or industrial property right treats both types of rights in one and the same law.

The types of rights falling under [Article 8\(4\) EUTMR](#) are:

- ‘non-registered trade marks’; and
- ‘other signs used in the course of trade’ such as:
  - trade names
  - company names
  - titles of publications or similar works
  - domain names.

The category of ‘other signs used in the course of trade’ within the meaning of [Article 8\(4\) EUTMR](#) mainly covers non-registered signs. However, the fact that a sign is also registered in accordance with the requirements of the respective national law does not bar it from being invoked under [Article 8\(4\) EUTMR](#).

### 3.2.2 Non-registered trade marks

Non-registered use-based trade marks exist in a number of the Member States <sup>(68)</sup> and are signs that indicate the commercial origin of a product or service. Therefore, they are signs that function as a trade mark. The rules and conditions governing acquisition of rights under the relevant national law vary from simple use to use having acquired a reputation. Neither is their scope of protection uniform, although it is generally quite similar to the scope of protection under the provisions in the EUTMR concerning registered trade marks.

[Article 8\(4\) EUTMR](#) reflects the existence of such rights in Member States and grants the proprietors of non-registered marks the possibility of preventing the registration of an EUTM application where they would succeed in preventing use of that EUTM application under the relevant national law, by showing that the conditions set by the national law for prohibiting use of the later EUTM are satisfied and the other conditions of [Article 8\(4\) EUTMR](#) are met. As non-registered trade marks are not protected at European Union level, a ‘European Union non-registered trade mark’ is not an eligible basis for opposition.

Example: 17/03/2011, [R 1529/2010-1](#), GLADIATOR / GLADIATOR, where a non-registered trade mark in the Czech Republic was invoked and the opposition upheld on that basis; 05/11/2007, [R 1446/2006-4](#), RM2000T / RM2000T, where a non-registered trade mark in Belgium was invoked and the opposition rejected as unfounded because non-registered trade marks are not protected in Belgium.

### 3.2.3 Other signs used in the course of trade

‘Other signs used in the course of trade’ is a broad category that is not enumerated in [Article 8\(4\) EUTMR](#). In order for such signs to come within the ambit of [Article 8\(4\)](#)

---

<sup>68</sup> Benelux, Croatia, Estonia, France, Hungary, Lithuania, Poland, Romania, Slovenia and Spain do not protect unregistered trade marks (unless, for some jurisdictions, they are considered well known within the meaning of Article 6bis of the Paris Convention).



[EUTMR](#), they must have an identifying function as to commercial origin, that is to say, they must serve to identify an economic activity engaged in by their proprietor (29/03/2011, [C-96/09 P](#), Bud, EU:C:2011:189, § 149). [Article 8\(4\) EUTMR](#) does not cover other types of intellectual property rights that are not ‘commercial signs’ — such as patents, copyrights or design rights that do not have a primarily identifying function but protect technical or artistic achievements or the ‘appearance’ of something.

Some examples of cases dealing with whether a right is a ‘sign’ for the purposes of [Article 8\(4\) EUTMR](#) are set out below.

Earlier right	Case No
JOSE PADILLA (copyright)	22/06/2010, <a href="#">T-255/08</a> , EU:T:2010:249
<p>The Court found that copyright cannot constitute a ‘sign used in the course of trade’ within the meaning of <a href="#">Article 8(4) EUTMR</a>. It is apparent from the scheme of Article 52 of Regulation No 40/94 [now <a href="#">Article 60 EUTMR</a>] that copyright is not such a sign. Article 52(1)(c) of Regulation No 40/94 [now <a href="#">Article 60(1)(c) EUTMR</a>] provides that a European Union trade mark is to be declared invalid where there is an earlier right as referred to in <a href="#">Article 8(4) EUTMR</a> and the conditions set out in that paragraph are fulfilled. Article 52(2)(c) of Regulation No 40/94 [now <a href="#">Article 60(2)(c) EUTMR</a>] provides that a European Union trade mark is also to be declared invalid where the use of such a trade mark may be prohibited pursuant to any ‘other’ earlier right and in particular a copyright. <b>It follows that copyright is not one of the earlier rights referred to in <a href="#">Article 8(4) EUTMR</a>.</b></p>	

Earlier right	Case No
Dr. No (copyright)	30/06/2009, <a href="#">T-435/05</a> , EU:T:2009:226
<p>[...] the protection provided for by <b>copyright cannot be relied on in opposition proceedings</b>, but only in proceedings for a declaration of invalidity of the European Union trade mark in question (para. 41).</p>	

Earlier rights	Case No
----------------	---------

 and  (Community designs)	07/09/2010, <a href="#">B 1 530 875</a>
Designs are a form of intellectual property dealing with the ornamental or aesthetic aspects of an article's appearance. Designs are deemed to be the result of a creative work that needs to be protected against unauthorised copying or imitation by third parties in order to ensure a fair return on investment. <b>They are protected as intellectual property, but they are not business identifiers or trade signs. Therefore, designs do not qualify as signs used in the course of trade for the purpose of <a href="#">Article 8(4) EUTMR</a>.</b>	

### 3.2.3.1 Trade names

Trade names are the names used to identify businesses, as distinguished from trade marks that identify goods or services as produced or marketed by a particular undertaking.

A trade name is not necessarily identical with the corporate name or commercial name entered in a commercial or similar register as trade names can cover other non-registered names such as a sign that identifies and distinguishes a certain establishment. Trade names are protected as exclusive rights in all Member States.

Pursuant to Article 8 of the Paris Convention, trade names enjoy protection without any registration requirement. If national legislation requires registration for national trade names, the respective provision is not applicable by virtue of Article 8 of the Paris Convention with respect to trade names held by a national of another contracting party to the Paris Convention. This applies as well in respect of nationals of a member of the WTO Agreement.

As regards the application of [Article 8\(4\) EUTMR](#) to trade names, where the trade name is invoked on the basis of the law of one of the Member States where a registration is a condition for the enforcement of rights in a trade name, the Office will apply this requirement where the Member State and the nationality of the opponent are the same, but will not apply this requirement in all other cases, since this would violate the provisions of Article 8 of the Paris Convention.

Examples: 16/08/2011, [R 1714/2010-4](#), where the Spanish trade name 'JAMON DE HUELVA' was invoked.

### 3.2.3.2 Company names

A company name is the official designation of an undertaking, in most cases registered in the respective national commercial register.

[Article 8\(4\) EUTMR](#) requires that actual use be shown, even if national law vests in the holder of such a name the right to prohibit the use of a subsequent trade mark on the basis of registration alone. However, if under national law registration is a prerequisite for protection, registration must be demonstrated as well. Otherwise, there would be no national right that the opponent could invoke.

Examples: 14/09/2011, [T-485/07](#), O-live, EU:T:2011:467, where the Spanish commercial name 'OLIVE LINE' was invoked and 08/09/2011, [R 21/2011-1](#), where the French company name 'MARIONNAUD PARFUMERIES' was invoked.

### 3.2.3.3 Domain names

A domain name is a combination of typographical characters corresponding to one or several numeric IP addresses that are used to identify a particular web page or set of web pages on the internet. As such, a domain name functions as an 'address' used to refer to a specific location on the internet (euipo.europa.eu) or an email address (@euipo.europa.eu).

Domain names are registered with organisations or commercial entities called 'domain name registrars'. Although a domain name is unique and may be a valuable commercial asset, a domain name registration per se is not an intellectual property right. Such registrations do not create any form of exclusive right. Instead, 'registration' in this context refers to a contractual agreement between a domain name registrant and the domain name registrar.

However, the **use** of a domain name may give rise to rights that can be the basis for an opposition under [Article 8\(4\) EUTMR](#). This can occur if through the use of the domain name it acquires protection as a non-registered trade mark or a trade sign identifying commercial origin under the applicable national law.

Examples: 07/12/2011, [R 275/2011-1](#), where rights based on the use of the German domain name 'lucky-pet.de' were invoked; [B 1 719 379](#), where rights based on the use of the French domain name 'Helloresto.fr' were invoked; 14/05/2013, [T-321/11](#) & [T-322/11](#), Partito della libertà, EU:T:2013:240, where rights based on the use of the Italian domain name 'partidodellaliberta.it' were invoked and the Court considered that references to this site in the Italian press did not in themselves substantiate its use in the context of a commercial activity.

### 3.2.3.4 Titles

Titles of magazines and other publications, or titles of similar categories of works such as films, television series, etc. fall under [Article 8\(4\) EUTMR](#) only if, under the applicable national law, they are protected as a trade sign identifying commercial origin.



The fact that the copyright in a title of a work can be invoked under the respective national law against a subsequent trade mark is not material for the purposes of [Article 8\(4\) EUTMR](#). As set out above, whilst a right in copyright may be used to invalidate an EUTM under [Article 60\(2\) EUTMR](#), it is only where a title has an ‘identifying’ function and acts as a trade sign identifying commercial origin that it comes within the scope of [Article 8\(4\) EUTMR](#). Therefore, for such signs to be relied on under [Article 8\(4\) EUTMR](#) in the context of opposition proceedings, the national law must envisage a protection that is independent from that recognised by copyright law (30/06/2009, [T-435/05](#), Dr. No, EU:T:2009:226, § 41-43.)

As with all rights under [Article 8\(4\) EUTMR](#), the title must have been used in the course of trade. This will normally require that the work to which the title relates must have been placed on the market. Where the title relates to a service (such as a television programme), the service must have been made available. However, there will be circumstances where pre-use advertising may be sufficient to create rights, and where such advertising will constitute ‘use’ within the meaning of [Article 8\(4\) EUTMR](#). In all cases, the title must have been used as an indicator of the commercial origin of the goods and services in question. Where a title is used only to indicate the artistic origin of a work, such use falls outside the scope of [Article 8\(4\) EUTMR](#) (30/06/2009, [T-435/05](#), Dr. No, EU:T:2009:226, § 25-31).

Example: 12/01/2012, [R 181/2011-1](#), where the magazine title ‘ART’ was invoked.

### 3.3 Use requirements

In order to successfully invoke [Article 8\(4\) EUTMR](#) in opposition proceedings, the earlier rights must be used. There are two different use requirement standards which must be taken into account:

- national standard
- European standard.

The two use requirement standards, however, clearly overlap. They must not be viewed in isolation but have to be assessed together. This applies, in particular, to the ‘intensity of use’ under the national standard and ‘use in trade of more than mere local significance’ under the European standard.

#### 3.3.1 National standard

The national standard is relevant as it defines the scope of protection of the earlier rights, which are often not easily identifiable, all the more so since their protection is not harmonised on an EU level (see [paragraph 3.5.2](#) below on the scope of protection). This standard determines the existence of the national right and the conditions of protection. For non-registered trade marks and other trade signs identifying commercial origin that do not require registration, use constitutes the only factual premise justifying the existence of the right, including ascertainment of the beginning of its existence. The national standard also prescribes the intensity of use under the relevant national law.

### 3.3.2 European standard — use in the course of trade of more than mere local significance

Under Article [8\(4\) EUTMR](#), the existence of an earlier non-registered trade mark or of another sign gives good grounds for opposition if the sign satisfies, inter alia, the following conditions: it must be **used in the course of trade** and the use must be of **more than mere local significance**.

The above two conditions are apparent from the very wording of [Article 8\(4\) EUTMR](#) (reiterated in [Article 7\(2\)\(d\) EUTMDR](#)), and must, therefore, be interpreted in the light of EU law. The common purpose of the two conditions laid down in [Article 8\(4\) EUTMR](#) is to limit conflicts between signs by preventing an earlier right that is not sufficiently definite — that is to say, important and significant in the course of trade — from preventing registration of a new European Union trade mark. A right of opposition of that kind must be reserved to signs which actually have a **real presence** on their relevant market (29/03/2011, [C-96/09 P](#), Bud, EU:C:2011:189, § 157).

#### 3.3.2.1 Use in the course of trade

The first requirement under [Article 8\(4\) EUTMR](#) is that the sign must be used in the course of trade.

The notion of ‘**use in the course of trade**’ in accordance with [Article 8\(4\) EUTMR](#) is not the same as ‘**genuine use**’ in accordance with [Article 47\(2\) and \(3\) EUTMR](#) (30/09/2010, [T-534/08](#), Granuflex, EU:T:2010:417, § 24-27). The aims and conditions connected with proof of genuine use of registered European Union or national trade marks are different from those relating to proof of use in the course of trade of the signs referred to in [Article 8\(4\) EUTMR](#) (09/07/2010, [T-430/08](#), Grain Millers, EU:T:2010:304, § 26; 29/03/2011, [C-96/09 P](#), Bud, EU:C:2011:189, § 143). Therefore, use must be interpreted according to the particular type of right at issue.

The Court of Justice ruled that the ‘use of the sign in the course of trade’ within the meaning of [Article 8\(4\) EUTMR](#) refers to the use of the sign ‘in the course of a commercial activity with a view to economic advantage and not as a private matter’ (12/11/2002, [C-206/01](#), Arsenal, EU:C:2002:651, § 40; 25/01/2007, [C-48/05](#), Opel, EU:C:2007:55, § 18; 11/09/2007, [C-17/06](#), Céline, EU:C:2007:497, § 17).

However, the Court of Justice also ruled that deliveries made without charge may be taken into account in order to ascertain whether the requirement for use of the earlier right in the course of trade has been met, since those deliveries could have been made in the context of a commercial activity with a view to economic advantage, namely to acquire new outlets (29/03/2011, [C-96/09 P](#), Bud, EU:C:2011:189, § 152).

As far as the **time of use** of the sign is concerned, an opponent must prove that use took place before the filing of the EUTM application or the priority date if relevant (29/03/2011, [C-96/09 P](#), Bud, EU:C:2011:189, § 166-168).

Earlier sign	Case No
BUD	29/03/2011, <a href="#">C-96/09 P</a> , EU:C:2011:189
<p>The Court discussed whether use that takes place exclusively or to a large extent between the filing of an application for registration and its publication was sufficient to meet the use requirement. One of the parties had argued that only the <b>acquisition</b> of the right had to take place before filing of the EUTM application but not its <b>use</b>. The Court applied the same temporal condition as to the acquisition of the right and concluded that use had to take place <b>before</b> the filing of the application. The Court of Justice considered that in view of the considerable period of time which may elapse between the filing of an application for registration and its publication, the obligation of use in the course of trade of the sign before the filing of the application guarantees that the use claimed for the sign concerned is real and not an exercise whose sole aim has been to prevent registration of a new trade mark (paras 166-168).</p>	

Moreover, it must be clear from the evidence that the use continues on the date of the filing of the opposition. In this context, [Article 7\(2\)\(d\) EUTMDR](#) expressly states that if an opposition is based on an earlier right within the meaning of [Article 8\(4\) EUTMR](#), the opponent must provide evidence of its acquisition, **continued existence** (emphasis added) and scope of protection of that right.

The following is an example of an *inter partes* case relating to invalidity proceedings. The reasoning and the findings also apply to oppositions, given that [Article 8\(4\) EUTMR](#) is a ground that can be invoked both in opposition and in invalidity.

Earlier sign	Case No
BAMBOLINA (non-registered mark in a number of MS)	30/07/2010, <a href="#">3 728 C</a> (confirmed 03/08/2011, <a href="#">R 1822/2010-2</a> ; 23/10/2013, <a href="#">T-581/11</a> , EU:T:2013:553)
<p>The evidence showed use in the course of trade of the non-registered trade mark for 3 years, not covering the last 2 years before the date of filing of the invalidity request. The Cancellation Division held that an earlier non-registered sign relied on in an invalidity action must be in use at the time of filing the request. Since for these signs use constitutes the factual premise justifying the existence of the right, the same factual premise must still exist, and be proven, on the date of filing of the invalidity request (30/07/2010, <a href="#">3 728 C</a>, paras 25-28). The Board confirmed the finding of the Cancellation Division, adding that Rules 19(1) and (2)(d) of Regulation No 2868/95 [now <a href="#">Article 7(1) and (2)(d) EUTMDR</a>] state that where an opposition is based on <a href="#">Article 8(4) EUTMR</a>, evidence of, inter alia, its 'continued existence' must be adduced within the period given by the Office for presenting or completing facts, evidence or arguments in support of the opposition. Failure to prove the existence, validity and scope of protection of the earlier mark or right within that period will lead to the opposition being rejected as unfounded. In the Board's opinion, these provisions applied <i>mutatis mutandis</i> to cancellation proceedings (03/08/2011, <a href="#">R 1822/2010-2</a>, para. 15).</p>	

The requirement that the sign be used in the course of trade must, as stated above, be interpreted in the light of EU law. It must be distinguished from the requirements provided for under the applicable national laws that might set specific requirements as far as the **intensity of the use** is concerned.

The European Union use requirement as prescribed by [Article 8\(4\) EUTMR](#) applies independently of whether national law allows prohibition of a subsequent trade mark on the basis of the registration of a sign alone, that is, without any requirement relating to use. The following is an example where the opponent relied on the registration, at national level, of a trade name, but failed to prove that the sign was used in trade.

Earlier sign	Case No
NACIONAL (Portuguese name of establishment)	07/02/2010, <a href="#">R 693/2011-2</a>
Under <a href="#">Article 8(4) EUTMR</a> , the fact that the opponent may, in accordance with the law of Portugal, have acquired exclusive rights plainly enforceable against subsequent trade marks on the basis of the registration of a 'name of establishment', does not exempt it from the burden of proving that the sign in question has been used in the course of trade of more than local significance. The mere fact that the sign is registered in accordance with the requirements of the respective Portuguese law is not in itself sufficient for the application of <a href="#">Article 8(4) EUTMR</a> (paras 20-26).	

Depending on the applicable national law, an opponent might have to prove not only that the sign relied on is used in the course of trade (this being, as stated, a requirement under EU law), but also that it has been **registered with the competent national authorities**. It would not be sufficient that the European Union requirement of 'use in trade' is met if the registration requirement is not fulfilled. However, under certain national laws, rights in a company name may be invoked, as long as the company name has been used, prior to the registration of the entity in the companies register. The following is an example where the opponent invoked prior rights in a company name used in the course of trade in Germany that was not registered at the time of filing the contested EUTM application.

Earlier sign	Case No
Grain Millers GmbH & Co. KG (German company name)	09/07/2010, <a href="#">T-430/08</a> , EU:T:2010:304

The opponent invoked under [Article 8\(4\) EUTMR](#) the company name ‘Grain Millers GmbH & Co. KG’ used in the course of trade in Germany for ‘flour, in particular wheat flour and rye flour’. Therefore, the opponent claimed the name of a GmbH (Gesellschaft mit beschränkter Haftung, ‘limited liability company’ in English). The applicant argued that, according to Article 11(1) German Limited Companies Act (GmbH Gesetz), a GmbH does not exist before its registration and that the opponent was therefore not entitled, in support of its opposition, to rely on its business name, because the company was registered only after the filing of the contested EUTM application. The Court took a different view and held that, according to the case-law of the German courts, the right to a business name exists pursuant to paragraph 5(2) of the Markengesetz from the first use in the course of trade, without the obligation to register (para. 36).

A sign is used in the course of trade where that use occurs in the context of **commercial activity with a view to economic advantage** and not as a private matter.

Therefore, the Office will reject an opposition in the absence of actual use of the invoked sign. The following are examples where the opponent failed to meet this basic requirement.

Earlier sign	Case No
Octopussy (film title, claimed to have been used in the course of trade in, inter alia, Germany)	20/04/2010, <a href="#">R 526/2008-4</a>
<p>The opponent merely submitted general information explaining the content of the film, its characters, gross figures, video offers on the internet and advertisements without any details as regards the relevant market. The information as regards turnover is also insufficient since it is too broad a general reference to the activities carried out by the opponent and does not specify either the type of activity or the territories concerned. For the same reason, the figures from a periodical, relating to the box office receipts generated by the film, have no bearing on the use of the sign in Germany. The remaining press articles furnished by the opponent concern subjects which cannot corroborate the use of the sign in the Member States indicated. The licence agreements for merchandising do not constitute any evidence with regard to the use of the sign as a film title. Lastly, the mere fact that the film was a worldwide success cannot substitute the obligation of the opponent to file concrete evidence with regard to the Member States in which it claims protection under <a href="#">Article 8(4) EUTMR</a> (para. 26).</p>	

Earlier sign	Case No
‘lucky-pet.de’ (German domain name)	07/12/2011, <a href="#">R 275/2011-1</a>

The opponent invoked under [Article 8\(4\) EUTMR](#) the domain name 'lucky-pet.de' used in the course of trade in Germany for 'mats for animals; retail services with respect to pet supplies'. It has not been proven that the domain has been used with more than local significance for the claimed goods and services. The invoices provided and the catalogue only show the internet address [www.lucky-pet.de](http://www.lucky-pet.de). However, they do not prove that the website [www.lucky-pet.de](http://www.lucky-pet.de) has been visited and, if so, to what extent. It has neither been stated nor proven by any document how many people visited the website and ordered products via email (para. 31).

### 3.3.2.2 Use of more than mere local significance

Rights falling under [Article 8\(4\) EUTMR](#) may only be invoked if their use is of more than mere local significance. This requirement applies for all the rights within the scope of [Article 8\(4\) EUTMR](#), that is, both to unregistered trade marks and to other trade signs identifying commercial origin. The proprietors of rights the use of which is of mere local significance retain their exclusive rights under the applicable national law pursuant to [Article 138 EUTMR](#).

The question whether the use of a non-registered sign is of more than mere local significance will be answered by applying a uniform European standard (18/04/2013, [T-506/11](#) & [T-507/11](#), Peek & Cloppenburg, EU:T:2013:197, § 19, 47-48).

The General Court held that the significance of a sign used to identify specific business activities must be established in relation to the identifying function of that sign. That consideration means that account must be taken, firstly, of the **geographical dimension** of the sign's significance, that is to say, of the territory in which it is used to identify its proprietor's economic activity, as is apparent from a textual interpretation of [Article 8\(4\) EUTMR](#). Account must be taken, secondly, of the **economic dimension** of the sign's significance, which is assessed in view of the length of time for which it has fulfilled its function in the course of trade and the degree to which it has been used, of the group of addressees among which the sign in question has become known as a distinctive element, namely consumers, competitors or even suppliers, or even of the exposure given to the sign, for example, through advertising or on the internet (24/03/2009, [T-318/06](#) – [T-321/06](#), General Optica, EU:T:2009:77, § 36-37; 30/09/2010, [T-534/08](#), Granuflex, EU:T:2010:417, § 19).

The Court of Justice clarified that the significance of a sign cannot be a function of the mere geographical extent of its protection, since, if that were the case, a sign whose protection is not merely local could, by virtue of that fact alone, prevent registration of a European Union trade mark, even though the sign might be used only to a very limited extent in the course of trade. The sign must be used in a sufficiently significant manner in the course of trade and its geographical extent must not be merely local, which implies, where the territory in which that sign is protected may be regarded as other than local, that the sign must be used in a **substantial part of that territory** (29/03/2011, [C-96/09 P](#), Bud, EU:C:2011:189, § 158-159).

However, it is not possible to establish a priori, in an abstract manner, which part of a territory must be used to prove that the use of a sign is of more than mere local significance. Therefore, the assessment of the sign's significance must be made *in concreto*, according to the circumstances of each case.

Therefore, the criterion of '**more than mere local significance**' is more than just a **geographical examination**. The **economic impact** of the use of the sign must also be evaluated. Consideration must be given, and the evidence must relate, to these elements:

1. the intensity of use (sales made under the sign);
2. the length of use;
3. the spread of the goods (location of the customers);
4. the advertising under the sign and the media used for that advertising, including the distribution of the advertising.

In the following example, both the geographic and the economic dimension of use of the sign were found to meet the standards.

Earlier sign	Case No
GLADIATOR (non-registered trade mark in the Czech Republic)	17/03/2011, <a href="#">R 1529/2010-1</a>
The around 230 invoices are sufficient to conclude that the sign 'GLADIATOR' has been used in the course of trade for 'all terrain vehicles'. They are issued to the opponent's clients in Czech cities such as 'Praha', 'Kraslice', 'Dolní Lánov', 'Pelhřimov', 'Opava', 'Bozkov', 'Plzeň' and many other Czech cities which cover many different areas of the Czech Republic. Furthermore, the catalogues and the magazines '4X4 Style' from 2007 are written in Czech and it is very likely that they are distributed in different venues within the Czech Republic. The documents such as the list of distributors, catalogues and magazines support the findings that the sign has been used in the course of trade (paras 22-33).	

As far as the use of the sign is concerned, in general, neither the territory of a city alone, even a large one, nor a regional district or province, is of more than mere local significance. It will depend on the circumstances of the case (see examples below). The leading judgment in this respect is the one rendered by the General Court in the *General Óptica* case, where use of the sign was confined to a specific locality and was, therefore, insufficient to meet the prescribed requirements.

Earlier sign	Case No
Generalóptica (Portuguese establishment name)	24/03/2009, <a href="#">T-318/06</a> – <a href="#">T-321/06</a> , EU:T:2009:77



It is not apparent from the evidence provided by the opponent that the significance of the sign relied on in the present case is more than merely local within the meaning of [Article 8\(4\) EUTMR](#). As the Board of Appeal stated in paragraph 33 of the contested decisions, it is apparent from the documents submitted by the opponent that at the time when registration of the first two European Union trade marks was applied for, the sign in question had been used for almost 10 years merely to designate a business establishment open to the public in the Portuguese town of Vila Nova de Famalicão, which has 120 000 inhabitants. In spite of its explanations at the hearing, the applicant did not provide any evidence of recognition of the sign by consumers or of its business relationships outside the abovementioned town. Likewise, the applicant has not shown that it had developed any advertising activity in order to ensure that its business establishment was promoted outside that town. It must therefore be held that the business establishment name Generalóptica is of mere local significance within the meaning of [Article 8\(4\) EUTMR](#) (para. 44).

Earlier sign	Case No
FORTRESS FORTRESS INVESTMENTS FORTRESS INVESTMENT GROUP (non-registered trade marks in the UK)	01/04/2011, <a href="#">R 354/2009-2</a> 08/03/2011, <a href="#">R 355/2009-2</a>
The fact that the invalidity applicant was involved in the acquisition, lease-back and management of nationwide property portfolios of major UK institutions and companies proves that the use was of more than mere local significance. The fact that use is limited to London is relevant in the sense that London is the seat of nearly all governmental institutions and bodies and home to the City of London, one of the leading financial centres of the world. The economic dimension of the sign's significance was important since by mid 2000, the invalidity applicant had already an equity capital under management in excess of USD 1 billion. Furthermore, the group of addressees among which the sign was known is significant since it included major players in the financial field and UK public institutions. The exposure given to the sign was also significant, cf. the national and specialised press coverage. Therefore, use in the course of trade was of more than mere local significance (paras 49-51).	

The notion that the use in trade of the sign relied on must be proven in the territory of the Member State/s where protection is sought is not incompatible with use of the sign in connection with **cross-border commercial transactions**.

Earlier sign	Case No
GRAIN MILLERS (German business name)	09/07/2010, <a href="#">T-430/08</a> , EU:T:2010:304



The use of a business name in the context of the importation of goods from another State (in this case, documents of the transaction concluded by opponent concerning the import of wheat from Romania to Germany) is indeed use in the context of a commercial activity with a view to economic advantage, since import-export constitutes a normal, everyday activity of an undertaking, necessarily involving at least two States (para. 41).

The following are examples where the opponent failed to prove that the **economic dimension** of the use of the signs concerned was sufficient to meet the prescribed legal requirements.

Earlier sign	Case No
BRIGHTON  (non-registered marks in the United Kingdom, Ireland, Germany and Italy)	30/06/2010,  <a href="#">R 408/2009-4</a>  (confirmed 27/09/2011, <a href="#">T-403/10</a> , EU:T:2011:538, § 38-40; dismissed 27/09/2012, <a href="#">C-624/11 P</a> , EU:C:2012:598, § 40-50)

The sales chart provided by the opponent shows that the sale activities in the Member States concerned were not consistent over time to the extent that for certain years no sales at all appear to have taken place and that for others the sales revenue was very low indeed. Therefore, the sales figures show that the opponent was not able to maintain an intensity of use of the signs over three consecutive years. It is unlikely in those cases that the public was able to memorise the mark as an indication of origin. The opponent did not submit any evidence relating to the advertising and promotion of the marks invested in the concerned Member States, or other material showing that the signs in question had established themselves in the marketplace to such an extent as to justify the acquisition of exclusive rights in non-registered trade marks (paras 12-21).

Earlier sign	Case No
  (Greek non-registered mark)	01/06/2011,  <a href="#">R 242/2010-1</a>

Although the documents confirm the geographical extent of the trade mark to Greece, the evidence regarding the extent of time of the alleged use is clearly insufficient. The last dated document is from 1997, i.e. seven years before the contested application was submitted. Moreover, the most recent documents in which the trade mark 'ESKIMO' can be seen are the invoices dating from 1991 to 1994. They only reflect the sales of a little less than 100 units throughout these four years, which cannot be deemed sufficient to prove the use of the mark as a business identifier by the opponent (paras 27-28).

Earlier sign	Case No
Up Way Systems – Representações Unipessoal LDA (Portuguese company name)	25/01/2013, <a href="#">R 274/2012-5</a>
Three invoices, addressed to companies in the Porto region of Portugal, for a total sales amount of EUR 16 314, are not sufficient to show that the sign was used in the course of trade, considering the price level of building materials and building services in general (paras 20-23).	

### 3.3.2.3 Nature of the use

Use of a sign relied on under [Article 8\(4\) EUTMR](#) must be made in accordance with the essential **function** of such a sign. This means that if an opponent relies on a non-registered trade mark, proof of use of the sign as a company name would not be sufficient to substantiate the earlier right.

The following is an example where the evidence shows use of a sign whose function does not correspond to that of the sign relied on.

Earlier sign	Case No
JAMON DE HUELVA (Spanish trade name)	16/08/2011, <a href="#">R 1714/2010-4</a>
The proof furnished in order to substantiate the use of 'Jamón de Huelva' almost exclusively relates to the designation of origin 'Jamón de Huelva'. Designations of origin are very different legal concepts from trade names, as, instead of identifying a particular commercial origin, they are geographical indications relating to an agricultural or food product of which the quality or characteristics are fundamentally or exclusively due to the geographical environment in which they are produced, processed or prepared. The opposition based on the use in Spain of the trade name 'Jamón de Huelva' must be dismissed in view of the fact that the proof furnished does not relate to this legal concept and does not identify a specific commercial activity, but instead the activities relating to a designation of origin and the Supervisory Council thereof (paras 34-37).	

The requirement that the sign must be used in trade for its own particular economic function does not exclude that the same sign might be used for several purposes.

It is common market practice to also use company or trade names as trade marks, either alone, or together with other product identifiers. This is the case when use of a 'house mark' is concerned, that is, an indication which usually coincides with the manufacturer's company or trade name and which not only identifies the product or service as such, but also provides a direct link between one or more product/service lines and a specific undertaking.

Therefore, depending on the specific circumstances of the case, in a case where an opponent relies on a non-registered trade mark, the use of the same sign as a company name or trade name may well also accomplish the function of indicating the origin of the goods/services concerned (thus, a trade mark function), as long as the sign is used in such a way that a link is established between the sign that constitutes the company or trade name and the goods marketed or the services provided (11/09/2007, [C-17/06](#), Céline, EU:C:2007:497, § 22-23).

As [Article 8\(4\) EUTMR](#) continues to apply to oppositions based on geographical indications filed before the entry into force on 23/03/2016 of [Regulation \(EU\) 2015/2424 amending Council Regulation \(EC\) No 207/2009 on the Community trade mark](#), the opponent is still required to **prove that the geographical indication is used in the course of trade of more than mere local significance**. Use must be made in accordance with the essential function of such a sign, namely **to guarantee to consumers in the course of trade the geographical origin of the goods and the special qualities inherent in them** (29/03/2011, [C-96/09 P](#), Bud, EU:C:2011:189, § 147, 149). Therefore, documents mentioning a geographical indication exclusively in a non-trade context are not sufficient for the purposes of [Article 8\(4\) EUTMR](#).

### 3.4 Earlier right

The right invoked under [Article 8\(4\) EUTMR](#) must be earlier than the EUTM application. In order to determine which of the conflicting rights is earlier, the relevant dates on which the rights were obtained must be compared.

- For the **EUTM application**, this is the filing date or any priority date validly claimed (EUTM date). Seniority claims, even if they relate to the Member State where the other earlier right is claimed to exist, are not relevant.
- As regards the **right falling under [Article 8\(4\) EUTMR](#)**, the relevant date of acquisition of exclusive rights under the national law is decisive (07/05/2013, [T-579/10](#), makro, EU:T:2013:232, where the Court confirmed the Board's rejection of evidence submitted by the invalidity applicant, which related to periods subsequent to the owner's application for the EUTM (§ 70).

Where mere use is sufficient under the national law, this must have begun before the EUTM date. Where recognition in the trade or reputation is required, this must have been acquired before the EUTM date. Where these conditions are fulfilled only after the EUTM date, the opposition will have to be rejected.

### 3.5 Right to prohibit the use of a subsequent trade mark under the applicable law

Earlier rights falling under [Article 8\(4\) EUTMR](#) are protected if they confer on their proprietors under the applicable law the right to prohibit use of a later trade mark.

This requires, firstly, a finding that under the applicable law, rights of the type involved, in the abstract, are exclusive rights enforceable by means of an injunction vis-à-vis later marks and, secondly, a finding that in the actual case under consideration the conditions for obtaining such injunctive relief, if the mark that is the subject of the opposed EUTM application were used in the territory in question, are present (scope of protection) (29/03/2011, [C-96/09 P](#), Bud, EU:C:2011:189, § 190). Both questions have to be answered in accordance with the applicable law.

### 3.5.1 The right of prohibiting use

[Article 8\(4\) EUTMR](#) requires a right that confers on its proprietor the right to prohibit **use** of a subsequent mark. Therefore, the opponent should invoke and submit those provisions of law that could be relied on in an action for infringement to prevent unauthorised use.

However, provisions of law prohibiting or invalidating the **registration** of a later sign may also be accepted. The right to oppose the registration of a later sign, implicitly, encompasses the right to oppose use of that sign. By opposing the registration of a later mark, the proprietor of the earlier right seeks effective protection against any future use of that mark. The concept of ‘the right to prohibit the use of a subsequent trade mark’ encompasses the case in which the owner of a sign has, under the applicable law, the power to prevent that use through an invalidity action against a subsequent trade mark (21/10/2014, [T-453/11](#), Laguiole, EU:T:2014:901, § 37; 24/10/2018, [T-435/12](#), 42 BELOW (FIG. MARK) / VODKA 42 (FIG. MARK), EU:T:2018:715, § 98-102; 19/04/2018, [C-75/17P](#), PALLADIUM PALACE IBIZA RESORT & SPA (fig.), EU:C:2018:269, § 60).

### 3.5.2 Scope of protection

For many, if not most of the rights falling under [Article 8\(4\) EUTMR](#), the prerequisites of national regulations are quite similar to those applied in conflicts between trade marks that Office examiners are familiar with, namely, likelihood of confusion, or damage to reputation or distinctiveness.

For example, unregistered marks are generally protected against subsequent marks in the event of a likelihood of confusion and, thus, in accordance with the same criteria that are applicable to conflicts between registered marks, namely, identity or similarity of the signs, identity or similarity of the goods or services, etc. In these cases, the criteria developed by the courts and by the Office for applying [Article 8\(1\) EUTMR](#) may easily be transported into [Article 8\(4\) EUTMR](#), unless the party claims that the relevant case-law of the national courts follows a different approach.

Where the applicable national law provides protection for unregistered trade marks that is different from that found in [Article 8\(1\) EUTMR](#), the scope of protection of the earlier right invoked follows from national law. If, for example, the applicable national law also grants protection to unregistered marks for dissimilar goods and services under certain conditions, the same protection will be granted under [Article 8\(4\) EUTMR](#).

## 4 Proof of the Applicable Law Governing the Sign

### 4.1 The burden of proof

According to [Article 95\(1\) EUTMR](#), in all *inter partes* cases, the burden is on the party making a particular claim or allegation to provide the Office with the necessary facts and arguments in order to substantiate the claim. Unlike other grounds in [Article 8 EUTMR](#), [Article 8\(4\) EUTMR](#) does not specify the conditions governing the acquisition and scope of protection of the earlier right invoked. It is a framework provision where the particulars of the applicable law must be provided by the opponent.

[Article 7\(2\)\(d\) EUTMDR](#) provides that if an opposition is based on an earlier right within the meaning of [Article 8\(4\) EUTMR](#), the opponent must provide, inter alia, evidence of its acquisition, continued existence and scope of protection, including where the earlier right is invoked pursuant to the law of a Member State, a clear identification of the contents of the national law relied upon by **adducing publications** of the relevant provisions or jurisprudence.

It follows from the law and it has been interpreted by the Court that the opponent must provide the content of the relevant national law and show that it would succeed under that national law in preventing the use of a subsequent trade mark.

In that regard, it should be observed that Article 8(4)(b) of Regulation No 40/94 [now [Article 8\(4\)\(b\) EUTMR](#)] lays down the condition that, pursuant to the law of the Member State governing the sign relied on under [Article 8\(4\)](#), that sign confers on its proprietor the right to prohibit the use of a subsequent trade mark.

Furthermore, in accordance with Article 74(1) of Regulation No 40/94 [now [Article 95\(1\) EUTMR](#)], the burden of proving that that condition is met lies with the opponent before the Office.

In that context and in relation to the earlier rights relied on ... regard must be had, in particular, to the national rules advanced in support of the opposition and to the judicial decisions delivered in the Member State concerned and that, on that basis, the opponent must establish that the sign concerned falls within the scope of the law of the Member State relied on and that it allows use of a subsequent mark to be prohibited.

(29/03/2011, [C-96/09 P](#), Bud, EU:C:2011:189, § 188-190.)

The Court held that in applications for a declaration of invalidity brought under Article 52(2) of Regulation No 40/94 [now [Article 60\(2\) EUTMR](#)], it is for the party who seeks to rely on an earlier right protected under national law

to provide the Office not only with particulars showing that he satisfies the necessary conditions, in accordance with the national law of which he is seeking application, in order to be able to have the use of an EU trade mark prohibited by virtue of an earlier right, but also particulars establishing the content of that law.

(05/07/2011, [C-263/09 P](#), Elio Fiorucci, EU:C:2011:452, § 50; 27/03/2014, [C-530/12 P](#), Mano, EU:C:2014:186, § 34.)

Although these judgments referred to invalidity proceedings under Article 52(2) of Regulation No 40/94 [now [Article 60\(2\) EUTMR](#)], since [Article 8\(4\) EUTMR](#) also concerns the application of earlier rights protected under European Union legislation or under the law of the Member State governing the sign at issue, the cited case-law also applies to oppositions brought under [Article 8\(4\) EUTMR](#).

The information on the applicable law must allow the Office to understand and apply the content of that law, the conditions for obtaining protection and the scope of this protection, and allow the applicant to exercise the right of defence. It may also be particularly useful to submit evidence of relevant case-law and/or jurisprudence interpreting the law invoked.

The Office must effectively assess the applicability of the ground for refusal invoked. In order to ensure the correct application of the law invoked, the Office has the power to verify, by whatever means it deems appropriate, the content, the conditions governing the application and the scope of the provisions of the applicable law relied upon by the opponent (27/03/2014, [C-530/12 P](#), Mano, EU:C:2014:186, § 44-46), while respecting the parties' right to be heard. If, after verifying the evidence submitted, the Office is of the opinion that the parties' proposed interpretation or application of the law invoked was inaccurate, it can introduce new and/or additional elements, or request clarification or supplementary evidence to that effect from the opponent (25/11/2020, [T-57/20](#), GROUP Company TOURISM & TRAVEL (fig.) / GROUP Company TOURISM & TRAVEL (fig.) et al., ECLI:EU:T:2020:559, § 34). In order to respect the parties' rights to be heard, the Office will invite the parties to comment on these elements, where appropriate.

This power of verification is limited to ensuring the **accurate application of the law relied upon by the opponent**. It does not therefore discharge the opponent from the burden of proof and it cannot serve to substitute the opponent in adducing the appropriate law for the purposes of its case (02/12/2020, [T-35/20](#), DEVICE OF CLAW-LIKE SCRATCH (fig.) / DEVICE OF A CLAW-LIKE SCRATCH (fig.), EU:T:2020:579, § 79-85; 28/04/2021, [T-284/20](#), HB Harley Benton (fig.) / HB et al., EU:T:2021:218, § 139-144).

## 4.2 Means of evidence and standard of proof

Pursuant to [Article 8\(4\) EUTMR](#), the applicable law may be the law of a Member State or European Union law.

### 4.2.1 National law

As regards national law, the opponent must provide:

1. the provisions of the applicable law:



- on the **conditions governing acquisition of rights** (whether there is a requirement of use and, if so, the standard of use required; whether there is a registration requirement, etc.); and
  - on the **scope of protection of the right** (whether it confers the right of prohibition of use; the injury against which protection is provided, e.g. likelihood of confusion, misrepresentation, unfair advantage, evocation).
2. particulars proving fulfilment of the conditions:
- of **acquisition** (entitlement; earlier acquisition; whether it is in force; evidence of use if use-based; evidence of registration if registration-based, etc.); and
  - of **the scope of protection** (facts, evidence and/or arguments that the requirements laid down by the applicable law for a prohibition of use are met, e.g. the nature of the goods, services or business activity protected by the earlier right and their relation with the contested goods or services; a cogent argument showing that there is a risk of injury).

**First, as regards the provisions of the applicable law** (see [paragraph 4.2.1 a](#)), the opponent must provide a clear identification of the contents of the national law relied upon by adducing publications of the relevant provisions or jurisprudence ([Article 7\(2\)\(d\) EUTMDR](#)). The opponent must provide the **reference** to the relevant legal provision (article number and the number and title of the law) and the **content** (text) of the legal provision by adducing publications of the relevant provisions or jurisprudence (e.g. excerpts from an official journal, a legal commentary, legal encyclopaedias or court decisions). If the relevant provision refers to a further provision of law, this must also be provided to enable the applicant and the Office to understand the full meaning of the provision invoked and to determine the possible relevance of this further provision. Where the evidence concerning the content of the relevant national law is accessible online from a source recognised by the Office, the opponent may provide such evidence by making a reference to that source ([Article 7\(3\) EUTMDR](#)) (see the Guidelines, [Part C, Opposition, Section 1, Opposition proceedings, paragraph 4.2.4.3](#)).

A mere reference to the case-law on which the applicant intends to rely in support of its argument in order to demonstrate the content of the legislation and the applicable case-law is insufficient to fulfil the obligations arising from [Article 7\(2\)\(d\) EUTMDR](#) (02/12/2020, [T-35/20](#), DEVICE OF CLAW-LIKE SCRATCH (fig.) / DEVICE OF A CLAW-LIKE SCRATCH (fig.), EU:T:2020:579, § 81).

As the opponent is required to **prove** the content of the applicable law, **it must provide the applicable law in the original language**. If that language is not the language of the proceedings, the opponent must also provide a **complete translation** of the legal provisions invoked in accordance with the standard rules of substantiation ([Article 7\(4\) EUTMDR](#), first sentence). However, a mere translation of the applicable law does not itself constitute proof and cannot substitute the original; therefore, the translation alone is not considered sufficient to prove the law invoked. [Article 7\(4\) EUTMDR](#) requires any provisions of the applicable national law governing the acquisition of the rights and their scope of protection, including evidence accessible online to be submitted in the language of the proceedings or accompanied by a translation into that language, which must be submitted within the time limit specified **for submitting the original**

**document.** The same rules apply where the opponent provides the content of the relevant national law by making reference to a relevant online source recognised by the Office.

Where the opponent seeks to rely on national case-law or jurisprudence interpreting the law invoked, it must provide the relevant information in sufficient detail (e.g. a copy of the decision invoked or excerpts from the legal literature). The translation rules apply equally to that evidence, including cases when the opponent provides such evidence by making reference to a relevant online source recognised by the Office.

**Second, as regards the particulars proving fulfilment of the conditions of the applicable law** (see [paragraph 4.2.1 b](#)), apart from providing appropriate evidence of acquisition of the right invoked, the opponent must submit evidence that the conditions of protection vis-à-vis the contested mark are actually met and, in particular, put forward a cogent line of argument as to why it would succeed in preventing the use of the contested mark under the applicable law. Merely providing the applicable law itself is not considered sufficient, as it is not up to the Office to make the relevant argument on behalf of the opponent.

Furthermore, in an opposition under [Article 8\(4\) EUTMR](#), what matters is whether the relevant provisions of the law conferring on the opponent the right to prohibit the use of a subsequent trade mark would apply to the contested mark in the abstract, and not whether the use of the contested mark could actually be prevented. Therefore, the applicant's argument in defence that the opponent had not hitherto invoked or had not hitherto been able to prevent the actual use of the contested mark in the relevant territory cannot succeed (29/03/2011, [C-96/09 P](#), Bud, EU:C:2011:189, § 191, 193).

Based on the above, the Office will reject the opposition if:

- the opponent invokes a right but does not include a **reference** to any specific national law and/or legal provision protecting that right (e.g. the opponent only indicates that the opposition is based on a commercial designation in Germany or that the opposition based on a commercial designation in Germany is protected under DE-TMA); or
- the opponent provides a reference to the applicable national law and legal provision(s) but the reference is not complete: the legal provision only indicates the conditions governing the **acquisition** of the right but not the **scope of protection** of the right (or vice versa) (e.g. the opponent indicates that the opposition is based on a commercial designation in Germany protected under Article 5 DE-TMA, which establishes the conditions for acquisition of the right, but the reference to the conditions governing the scope of protection, Article 15 DE-TMA, is missing); or
- the opponent provides the reference to the relevant legal provision but does not provide the **content** (text) of the legal provision (e.g. the opponent's submission refers to the DE-TMA but does not include the content of the law); or
- the opponent provides the content of the legal provision only in the language of the proceedings but not in the **original language** (e.g. the language of the proceedings is English but the text of the DE-TMA is submitted only in English, not in German); or



- the opponent does not provide any or sufficient evidence of the acquisition of the right invoked or does not provide arguments as to why it fulfils the conditions governing the scope of protection (e.g. the opponent refers to the relevant legal provisions and provides their content both in the original language and translated into the language of the proceedings, but does not provide any or sufficient evidence of the acquisition of protection or does not state whether it fulfils the conditions of the scope of protection).

#### 4.2.2 European Union law

The above requirements also apply to European Union law, except that the opponent is not obliged to provide the content (text) of the law invoked. However, the opponent has to provide particulars proving the fulfilment of the conditions under the relevant provisions of European Union law ([paragraph 4.2.1. b](#) above).

***GUIDELINES FOR EXAMINATION OF  
EUROPEAN UNION TRADE MARKS***

***EUROPEAN UNION  
INTELLECTUAL PROPERTY OFFICE  
(EUIPO)***

***Part C***

***Opposition***

***Section 5***

***Trade marks with reputation (Article 8(5)  
EUTMR)***

## Table of Contents

<b>1 Introduction.....</b>	<b>1214</b>
<b>1.1 Purpose of Article 8(5) EUTMR.....</b>	<b>1214</b>
<b>1.2 Legal framework.....</b>	<b>1214</b>
<b>2 Scope of Application.....</b>	<b>1215</b>
<b>2.1 Applicability to registered marks.....</b>	<b>1215</b>
2.1.1 The requirement of registration.....	1215
2.1.2 Relationship between marks with reputation (Article 8(5) EUTMR) and well-known marks (Article 8(2)(c) EUTMR).....	1216
<b>2.2 Applicability to similar and identical goods and services.....</b>	<b>1218</b>
<b>3 Conditions of Application.....</b>	<b>1218</b>
<b>3.1 Earlier mark with reputation.....</b>	<b>1219</b>
3.1.1 Nature of reputation.....	1219
3.1.2 Scope of reputation.....	1220
3.1.2.1 Degree of recognition.....	1220
3.1.2.2 Relevant public.....	1221
3.1.2.3 Goods and services covered.....	1224
3.1.2.4 Relevant territory.....	1225
3.1.2.5 Relevant point in time.....	1227
3.1.2.6 Reputation acquired as part of another mark.....	1230
3.1.3 Assessment of reputation — relevant factors.....	1232
3.1.3.1 Trade mark awareness.....	1234
3.1.3.2 Market share.....	1235
3.1.3.3 Intensity of use.....	1238
3.1.3.4 Geographical extent of use.....	1240
3.1.3.5 Duration of use.....	1241
3.1.3.6 Promotional activities.....	1242
3.1.3.7 Other factors.....	1244
3.1.4 Proof of reputation.....	1246
3.1.4.1 Standard of proof.....	1246
3.1.4.2 Burden of proof.....	1246
3.1.4.3 Evaluation of the evidence.....	1247
3.1.4.4 Means of evidence.....	1248
<b>3.2 The similarity of the signs.....</b>	<b>1259</b>
<b>3.3 The link between the signs.....</b>	<b>1262</b>

<b>3.4 The risk of injury .....</b>	<b>1268</b>
3.4.1 Protected subject matter.....	1268
3.4.2 Assessment of the risk of injury.....	1269
3.4.3 Types of injury.....	1269
3.4.3.1 Taking unfair advantage of distinctiveness or repute.....	1270
3.4.3.2 Detriment to distinctiveness.....	1279
3.4.3.3 Detriment to repute.....	1285
3.4.4 Proving the risk of injury.....	1291
<b>3.5 Use without due cause.....</b>	<b>1292</b>
3.5.1 Examples of due cause.....	1293
3.5.1.1 Due cause was accepted.....	1293
3.5.1.2 Due cause was not accepted.....	1294

## 1 Introduction

### 1.1 Purpose of Article 8(5) EUTMR

Whereas, under [Article 8\(1\)\(a\) EUTMR](#), double identity of signs and goods/services and, under [Article 8\(1\)\(b\) EUTMR](#), a likelihood of confusion are the necessary preconditions for the protection of a registered trade mark, [Article 8\(5\) EUTMR](#) requires neither identity/similarity of goods/services nor a likelihood of confusion. [Article 8\(5\) EUTMR](#) grants protection for registered trade marks not only as regards identical/similar goods/services but also in relation to dissimilar goods/services without requiring any likelihood of confusion, provided the signs are identical or similar, the earlier mark enjoys a reputation, and the use without due cause of the trade mark applied for would take unfair advantage of, or be detrimental to, the distinctive character or repute of the earlier mark.

The rationale behind the extended protection under [Article 8\(5\) EUTMR](#) is the consideration that the function and value of a trade mark are not confined to its being an indicator of origin. A trade mark can also convey messages other than an indication of the origin of the goods and services, such as a promise or reassurance of quality or a certain image of, for example, luxury, lifestyle, exclusivity, etc. ('advertising function') (18/06/2009, [C-487/07](#), L'Oréal, EU:C:2009:378). Trade mark owners frequently invest large sums of money and effort in creating a certain brand image associated with their trade mark. This image associated with a trade mark confers on it an — often significant — economic value, which is independent of that of the goods and services for which it is registered.

[Article 8\(5\) EUTMR](#) aims at protecting this advertising function and the investment made in creating a certain brand image by granting protection to reputed trade marks, irrespective of the similarity of the goods or services or of a likelihood of confusion, provided it can be demonstrated that use of the contested application without due cause would take unfair advantage of, or be detrimental to, the distinctive character or repute of the earlier mark. Consequently, the main focus of [Article 8\(5\) EUTMR](#) is not the protection of the general public against confusion as to origin, but rather the protection of the trade mark proprietor against use that takes unfair advantage of, or is detrimental to, the distinctive character or repute of a mark for which it has made significant investments.

### 1.2 Legal framework

According to [Article 8\(5\) EUTMR](#), upon opposition by the proprietor of a registered earlier trade mark within the meaning of [paragraph 2](#), the trade mark applied for will not be registered:

‘where it is identical with, or similar to, an earlier trade mark, irrespective of whether the goods or services for which it is applied are identical with, similar to or not similar to those for which the earlier trade mark is registered, where, in the case of an earlier EU trade mark, the trade mark has a reputation in the Union or, in the case of an earlier national mark, the trade mark has a reputation in the Member State concerned, and where the use without due cause of the trade mark applied for would take unfair advantage of, or be detrimental to, the distinctive character or the repute of the earlier trade mark.’

The same wording is used in the parallel provision of **Directive (EU) 2015/2436 approximating the laws of the Member States relating to trade marks** ([‘TMD’](#)), namely [Article 5\(3\)\(a\) TMD](#).

The wording of [Article 8\(5\) EUTMR](#) is also very similar to that used in [Article 9\(2\)\(c\) EUTMR](#) and [Article 10\(2\)\(c\) TMD](#), that is, the provisions determining the exclusive rights of a trade mark proprietor, with only a slight difference in the way these refer to the condition of detriment. Unlike the conditional form in [Article 8\(5\) EUTMR](#), which applies where use of the trade mark applied for ‘**would take** unfair advantage of, **or be** detrimental to, the distinctive character or the repute of the earlier mark’, [Article 9\(2\)\(c\) EUTMR](#) and [Article 10\(2\)\(c\) TMD](#) read ‘**takes** unfair advantage of, **or is** detrimental to’. The reason for this difference is that in the first case – [Article 8\(5\) EUTMR](#) – registrability is at stake, which may have to be decided upon without any use of the later mark having been made, while in the second case the prohibition of use is at issue. The impact of this difference on the kind of evidence required for proving detriment in either case is discussed in [paragraph 3.4](#).

## 2 Scope of Application

The previous wording of [Article 8\(5\) EUTMR](#), which was applicable until 23/03/2016, gave rise to some controversy as regards its applicability exclusively to (a) earlier registered marks and (b) dissimilar goods and services. As these issues directly affected the scope of its application, it was necessary to clarify whether it was possible to also apply [Article 8\(5\) EUTMR](#) to (a) unregistered/well-known marks and (b) similar or identical goods and services.

### 2.1 Applicability to registered marks

#### 2.1.1 The requirement of registration

According to the clear wording of the current version of [Article 8\(5\) EUTMR](#), as introduced by [Amending Regulation \(EU\) 2015/2424](#), this norm protects a ‘registered earlier trade mark’. Even if the requirement of registration was not expressly mentioned in the previous version of this provision, the Office interpreted it in this way, since according to its wording the applicability of the provision was restricted, indirectly but clearly, to **earlier registered trade marks** by prohibiting registration where [the

application] was identical or similar to the earlier trade mark and was to be registered for goods and services that were not similar to those for which the **earlier trade mark was registered**. It follows that the existence of an **earlier registration** has always been a **necessary condition** for the application of [Article 8\(5\) EUTMR](#) and that, as a consequence, the reference to [Article 8\(2\) EUTMR](#) should be limited to earlier registrations and earlier applications subject to their registration (11/07/2007, [T-150/04](#), Tosca Blu, EU:T:2007:214, § 55).

### 2.1.2 Relationship between marks with reputation (Article 8(5) EUTMR) and well-known marks (Article 8(2)(c) EUTMR)

The requirement of **registration** serves to mark the border between [Article 8\(5\) EUTMR](#) and [Article 8\(2\)\(c\) EUTMR](#). However, neither [Article 8\(2\)\(c\) EUTMR](#) nor Article 6*bis* of the Paris Convention stipulate expressly that the well-known mark has to be a non-registered mark. The reason for the principle that only non-registered marks are covered by these latter provisions results indirectly both from the spirit and the *ratio legis* of these provisions.

As regards the Paris Convention, the purpose of the provision of Article 6*bis*, introduced for the first time in the Convention in 1925, was to prevent the registration and use of a trade mark liable to create confusion with another mark already well known in the country of such registration, even where the latter well-known mark was not, or not yet, protected in that country by registration.

As regards the EUTMR, the purpose was to close a legal gap as [Article 8\(5\) EUTMR](#) protects only registered EUTMs. Without [Article 8\(2\)\(c\) EUTMR](#), reputed non-registered trade marks would have remained without protection (apart from that of [Article 8\(4\) EUTMR](#)). In order to close this legal gap, the EUTMR provided for the protection of well-known marks within the sense of Article 6*bis* of the Paris Convention, as this Article had been drawn up mainly to afford protection to non-registered trade marks with a well-known character.

Consequently, on the one hand, **well-known marks** that are **not registered** in the relevant territory cannot be protected under [Article 8\(5\) EUTMR](#) against dissimilar goods. They can only be protected against **identical or similar goods** if there is a likelihood of confusion pursuant to [Article 8\(1\)\(b\) EUTMR](#), to which [Article 8\(2\)\(c\) EUTMR](#) refers for determining the scope of protection. However, this is without prejudice to the fact that well-known marks, to the extent that they are not registered, may also be protected under [Article 8\(4\) EUTMR](#). Therefore, if the relevant national law affords them protection against dissimilar goods and services, such enhanced protection may also be invoked under [Article 8\(4\) EUTMR](#).

On the other hand, where well-known marks have been **registered**, either as EUTMs or as national marks in one of the Member States, they **can be invoked under [Article 8\(5\) EUTMR](#)**, but only if they also **fulfil the requirements of reputation**.

Even though the terms ‘well known’ (a traditional term used in Article 6*bis* of the Paris Convention) and ‘reputation’ denote distinct legal concepts, there is a **substantial overlap** between them. This is shown by a comparison of how well-known marks are

defined in the WIPO Joint Recommendation Concerning Provision on the Protection of Well-Known Marks with how reputation was described by the Court of Justice in its judgment of 14/09/1999, [C-375/97](#), *Chevy*, EU:C:1999:408, § 22 (concluding that the different terminology is merely a ‘... nuance, which does not entail any real contradiction ...’).

In practical terms, the threshold for establishing whether a trade mark is well known or enjoys reputation will usually be the same. Therefore, it will not be unusual for a mark that has acquired well-known character to have also reached the threshold laid down by the Court in *Chevy (General Motors)* for marks with reputation, given that in both cases the assessment is principally based on quantitative considerations regarding the degree of knowledge of the mark among the public, and that the thresholds required for each case are expressed in quite similar terms (‘known ...’ or ‘well known in at least one relevant sector of the public’<sup>69</sup>) for well-known marks, and ‘known by a significant part of the public concerned’ for marks with reputation).

This has also been confirmed by case-law. In its judgment of 22/11/2007, [C-328/06](#), *Fincas Tarragona*, EU:C:2007:704, the Court qualified the notions of ‘reputation’ and ‘well known’ as kindred concepts, underlining in this way the substantial overlap and relationship between them (para. 17). See also the judgment of 11/07/2007, [T-150/04](#), *Tosca Blu*, EU:T:2007:214, § 56-57.

The overlap between marks with reputation and registered well-known marks has repercussions when grounds of opposition are raised, in the sense that it should not matter for the applicability of [Article 8\(5\) EUTMR](#) if the opponent calls its earlier registration a well-known mark instead of a mark with reputation. For this reason, the terminology used must be carefully scrutinised, especially where the grounds of the opposition are not clearly explained, and a flexible approach should be taken where appropriate.

In the context of [Article 8\(2\)\(c\) EUTMR](#), the requirements for applying Article 6*bis* of the Paris Convention and [Article 8\(1\)\(a\) or \(b\) EUTMR](#) are the same, although the terminology used is different. Both provisions require similarity or identity between the goods or services, and similar or identical signs (Article 6*bis* uses the terms ‘reproduction’, which is equivalent to identity, and ‘imitation’, which refers to similarity). Both Articles also require a likelihood of confusion (‘liable to create confusion’ is the phrase used in Article 6*bis*). However, while according to [Article 8\(2\)\(c\) EUTMR](#) a well-known mark can serve as an earlier right and, thus, as the **basis** of an opposition, the **grounds** for an opposition under [Article 8\(2\)\(c\) EUTMR](#) are (solely) [Article 8\(1\)\(a\) or \(b\) EUTMR](#).

For example, if the opponent bases the opposition on (i) an earlier registration invoking [Article 8\(1\)\(b\) EUTMR](#) and [Article 8\(5\) EUTMR](#) and (ii) an identical earlier well-known mark in the same territory under [Article 8\(2\)\(c\) EUTMR](#), the earlier right must be examined:

---

<sup>69</sup> Article 2(2)(b) and 2(2)(c) of the WIPO Joint Recommendation Concerning Provisions on the Protection of Well-Known Marks.



1. under [Article 8\(1\)\(b\) EUTMR](#), as an earlier **registration** with enhanced distinctiveness (in view of its well-known character);
2. under [Article 8\(5\) EUTMR](#), as an earlier **registration** with reputation;
3. under [Article 8\(2\)\(c\) EUTMR](#) in conjunction with [Article 8\(1\)\(b\) EUTMR](#), as an earlier **non-registered well-known mark** (which will only be useful if registration is not proven, as otherwise the outcome is the same as in bullet point 1).

Even if the opponent has not expressly based its opposition on [Article 8\(5\) EUTMR](#), the contents of the notice and the wording of the explanation of grounds must be carefully analysed with a view to objectively establishing whether the opponent also wants to rely on [Article 8\(5\) EUTMR](#).

## 2.2 Applicability to similar and identical goods and services

According to the clear wording of the current version of [Article 8\(5\) EUTMR](#), the protection provided by this provision is ‘irrespective of whether the goods or services for which [the later mark] is applied are identical with, similar to or not similar to those for which the earlier trade mark is registered’. This is a codification of the case-law of the Court of Justice, interpreting the previous version of the provision (09/01/2003, [C-292/00](#), Davidoff, EU:C:2003:9).

## 3 Conditions of Application

The following conditions need be met for [Article 8\(5\) EUTMR](#) to apply (16/12/2010, [T-345/08](#) & [T-357/08](#), Botolist / Botocyl, EU:T:2010:529, confirmed 10/05/2012, [C-100/11 P](#), Botolist / Botocyl, EU:C:2012:285):

1. earlier **registered mark with reputation** in the relevant territory;
2. **identity or similarity** between the contested EUTM application and the earlier mark;
3. use of the sign applied for must be capable of taking an unfair advantage of, or being detrimental to, the distinctiveness or the repute of the earlier mark;
4. such use must be **without due cause**.

These conditions are **cumulative** and failure to satisfy any one of them is sufficient to render that provision inapplicable (25/05/2005, [T-67/04](#), Spa-Finders, EU:T:2005:179, § 30; 22/03/2007, [T-215/03](#), Vips, EU:T:2007:93, § 34; 16/12/2010, [T-345/08](#) & [T-357/08](#), Botolist / Botocyl, EU:T:2010:529, § 41).

The order in which these requirements are examined may vary depending on the circumstances of each case. For instance, the examination may start by assessing the similarities between the signs, especially where there is little or nothing to say on the subject, either because the marks are identical or because they are patently similar or dissimilar.

### 3.1 Earlier mark with reputation

#### 3.1.1 Nature of reputation

The nature and scope of reputation are not defined by either the [EUTMR](#) or the [TMD](#). Furthermore, the terms used in the different language versions of these texts are not fully equivalent, which has led to considerable confusion as to the true meaning of the term 'reputation', as admitted by Advocate General Jacobs in his opinion of 26/11/1998, [C-375/97](#), Chevy, EU:C:1998:575, § 34-36.

Given the lack of statutory definition, the Court defined the nature of reputation by reference to the purpose of the relevant provisions. In interpreting [Article 5\(2\) TMD](#), the Court held that the text of the [TMD](#) 'implies a **certain degree of knowledge of the earlier trade mark** among the public' and explained that it 'is only where there is a sufficient degree of knowledge of that mark that the public, when confronted by the later trade mark, may possibly make an association between the two trade marks ... and that the earlier mark may consequently be damaged' (14/09/1999, [C-375/97](#), Chevy, EU:C:1999:408, § 23).

In view of these considerations, the Court concluded that reputation is a **knowledge threshold requirement**, implying that it must be principally assessed on the basis of **quantitative** criteria. In order to satisfy the requirement of reputation, the earlier mark must be known by a significant part of the public concerned by the goods or services covered by that trade mark (14/09/1999, [C-375/97](#), Chevy, EU:C:1999:408, § 22-23; 25/05/2005, [T-67/04](#), Spa-Finders, EU:T:2005:179, § 34).

Moreover, if reputation is to be assessed on the basis of quantitative criteria, arguments or evidence relating to the esteem in which the public might hold the mark, rather than to its recognition, are not directly relevant for establishing that the earlier mark has acquired sufficient reputation for the purposes of [Article 8\(5\) EUTMR](#). However, as the economic value of reputation is also the protected subject-matter of this provision, any **qualitative aspects** thereof are relevant when assessing the possibility of detriment or unfair advantage (see also [paragraph 3.4](#) below). [Article 8\(5\) EUTMR](#) protects 'famous' marks not as such, but rather for the success and renown ('goodwill') they have acquired in the market. A sign does not enjoy any reputation inherently, for example, simply because it refers to a renowned person or event, but only for the goods and services it designates and the use that has been made of it.

Case No	Comment
22/07/2010, <a href="#">R 11/2008-4</a> , CASAS DE FERNANDO ALONSO (fig.) / FERNANDO ALONSO	All the evidence submitted by the opponent related to the fame of Fernando Alonso as a champion racing driver and to the use of his image by different undertakings to promote their goods and services. There was no proof of reputation for use of the earlier mark as registered for the relevant goods and services (paras 44 and 48).
03/03/2011, <a href="#">R 201/2010-2</a> , BALMAIN ASSET MANAGEMENT / BALMAIN (fig.)	The only items of evidence regarding reputation of the earlier mark submitted within the time limit, namely a page showing websites containing the word 'BALMAIN', a Wikipedia extract about the French designer Pierre Balmain, and five extracts from the website www.style.com referring to the 'BALMAIN' wear collection, were clearly not sufficient to establish the reputation of the earlier mark in the EU. Therefore, the opposition was rejected as unsubstantiated (paras 36 and 37).

### 3.1.2 Scope of reputation

#### 3.1.2.1 Degree of recognition

Having defined reputation as a knowledge threshold requirement, the question that necessarily follows is **how much awareness** the earlier mark must attain among the public in order to pass this threshold. The degree of knowledge required must be considered to be reached when the earlier trade mark is **known by a significant part** of the public, which, however, cannot be determined in advance by reference to a given percentage (14/09/1999, [C-375/97](#), Chevy, EU:C:1999:408, § 25-26; 16/11/2011, [T-500/10](#), Doorsa, EU:T:2011:679, § 45).

By refraining from defining in more detail the meaning of the term 'significant' and by stating that the trade mark does not have to be known by a given percentage of the public, the Court in substance advised **against the use of fixed criteria** of general applicability, since a predetermined degree of recognition may not be appropriate for a realistic assessment of reputation if taken alone.

Hence, in determining whether the earlier mark is known by a significant part of the public, account must be taken not only of the degree of awareness of the mark, but also of **any other factor** relevant to the specific case. For more about the relevant factors and their interplay, see [paragraph 3.1.3](#).

However, where goods or services concern quite **small groups of consumers**, the limited overall size of the market means that a significant part thereof is also restricted in absolute numbers. Hence, the limited size of the relevant market should not be regarded in itself as a factor capable of preventing a mark from acquiring a reputation within the meaning of [Article 8\(5\) EUTMR](#), as reputation is more a question of proportions and less of absolute numbers.

The need for the earlier mark to be known by a significant part of the public also serves to mark the difference between the notions of **reputation** as a necessary condition for the application of [Article 8\(5\) EUTMR](#) and **enhanced distinctiveness through use** as a factor for evaluating likelihood of confusion for the purposes of [Article 8\(1\)\(b\) EUTMR](#).

Even though both terms are concerned with the recognition of the mark among the relevant public, in the case of **reputation** a **threshold** exists below which extended protection cannot be granted, whereas in the case of **enhanced distinctiveness** there is **no threshold**. It follows that in the latter case any indication of enhanced recognition of the mark should be taken into account and evaluated according to its significance, regardless of whether it reaches the limit required by [Article 8\(5\) EUTMR](#). Therefore, a finding of ‘enhanced distinctiveness’ under [Article 8\(1\)\(b\) EUTMR](#) will not necessarily be conclusive for the purposes of [Article 8\(5\) EUTMR](#).

Case No	Comment
21/04/2010, <a href="#">R 1054/2007-4</a> , MANDARINO (fig.) / MANDARINA DUCK (fig.)	The documents submitted by the opponent showed promotional efforts in such a way that the distinctiveness was increased through use. However, the use was not enough to reach the threshold of reputation. None of the documents referred to the recognition of the earlier trade mark by the relevant end consumers; nor was any evidence submitted about the market share of the opponent’s goods (para. 61).

### 3.1.2.2 Relevant public

In defining the kind of public that should be taken into account for assessing reputation, the Court held that the ‘public amongst which the earlier trade mark must have acquired a reputation is **that [public] concerned by that trade mark**, that is to say, depending on the product or service marketed, either the public at large or a more specialised public, for example traders in a specific sector’ (14/09/1999, [C-375/97](#), Chevy, EU:C:1999:408, § 24; 25/05/2005, [T-67/04](#), Spa-Finders, EU:T:2005:179, § 34, 41).

Hence, if the goods and services covered by the mark are **mass consumption** products, the relevant public will be the **public at large**, whereas if the designated

goods have a very **specific application** or exclusively target **professional or industrial users**, the relevant public will be limited to the **specific purchasers** of the products in question.

Case No	Comment
04/08/2011, <a href="#">R_1265/2010-2</a> , MATTONI (fig.) / MATTONI	Taking into account the nature of the goods for which the opponent claims reputation, namely <i>mineral water</i> , the relevant public is the public at large (para. 44).
15/09/2011, <a href="#">R_2100/2010-1</a> , SEXIALIS / CIALIS et al.	The goods for which the sign enjoys reputation are <i>medicinal preparations for the treatment of sexual dysfunction</i> . The relevant public is the general public and professionals with a high level of attention (para. 64).
16/12/2010, <a href="#">T-345/08</a> & <a href="#">T-357/08</a> , Botolist / Botocyl; confirmed 10/05/2012, <a href="#">C-100/11 P</a> , Botolist / Botocyl	The goods for which the earlier mark enjoys reputation are <i>pharmaceutical preparations for the treatment of wrinkles</i> . The evidence of the promotion of the earlier mark 'BOTOX' in English in the scientific and general-interest press was sufficient to establish the mark's reputation amongst both the general public and health-care professionals ( <a href="#">C-100/11 P</a> , paras 65 to 67). Therefore, both these categories of consumers have to be taken into account.

In addition to the actual buyers of the relevant goods, the notion of the relevant public extends to the **potential purchasers** thereof, as well as to those members of the public that only come **indirectly into contact** with the mark, to the extent that such consumer groups are also targeted by the goods in question, for instance, sports fans in relation to athletic gear, or frequent air-travellers as regards air carriers, etc.

Case No	Comment
10/05/2007, <a href="#">T-47/06</a> , Nasdaq, EU:T:2007:131	The relevant services are stock exchange price quotation services in Classes 35 and 36, which normally target professionals. The opponent submitted evidence showing that the mark 'NASDAQ' appears almost daily in many <b>newspapers</b> and on many <b>television channels</b> that can be read/viewed throughout Europe. Therefore, the Board was right to hold that the reputation of the trade mark 'NASDAQ' had to be determined for European consumers not only among the professional public, but also in an important subsection of the general public (paras 47 and 51).
06/07/2012, <a href="#">T-60/10</a> , Royal Shakespeare, EU:T:2012:348	The evidence submitted in respect of reputation supports and reinforces the fact that the relevant public for <i>theatre productions</i> is the public at large and not a limited and exclusive circle. The intervener's activities were advertised, presented and commented on in numerous newspapers targeting the public at large. The intervener toured different regions throughout the United Kingdom and performed before a wide public in the United Kingdom. An activity on a large scale and, hence, a service offered to the public at large, is reflected both in the high turnover and the high box-office sales. Furthermore, it is clear from the documents submitted by the intervener that the intervener received substantial annual sponsorship income from undertakings in diverse sectors that also reach the public at large, such as banks, undertakings in the alcoholic drinks sector and car manufacturers (paras 35 and 36).

Quite often, a given product will concern **various purchaser groups** with different profiles, as in the case of multipurpose goods or goods that are handled by several intermediaries before they reach their final destination (distributors, retailers, end-users). In such cases the question arises whether reputation has to be assessed within each separate group or if it should cover all the different types of purchaser. The example given by the Court in its judgment of 14/09/1999, [C-375/97](#), Chevy, EU:C:1999:408 (traders in a specific sector) implies that reputation within one single group may suffice.

Likewise, if the earlier trade mark is registered for quite **heterogeneous goods/ services**, different segments of the public may be concerned by each type of good/ service, and, therefore, the overall reputation of the mark will have to be assessed separately for each category of goods involved.

The foregoing only deals with the kind of public to be taken into account when assessing whether the earlier mark has reached the threshold of reputation laid down by the Court in *Chevy (General Motors)*. However, a relevant question arises when assessing detriment or unfair advantage, namely whether the earlier mark must also be known to the public concerned by the goods and services of the later mark, since otherwise it is difficult to see how the public will be in a position to associate the two. This issue is discussed in [paragraph 3.4](#) below.

### 3.1.2.3 Goods and services covered

The goods and services must first of all be those for which the earlier trade mark is registered and for which reputation is claimed.

Case No	Comment
28/04/2011, <a href="#">R 1473/2010-1</a> , SÜEDTIROL / SÜDTIROL (fig.) et al.	The opposition was dismissed since the earlier marks were not registered for the services that, according to the opponent, enjoy a reputation. <a href="#">Article 8(5) EUTMR</a> can only be invoked if the trade mark affirmed to be well known/renowned is a registered trade mark and if the goods/services for which this reputation/renown is claimed appear on the certificate (para. 49).

The goods and services to which the evidence refers have to be identical (not only similar) to the goods and services for which the earlier trade mark is registered.

Case No	Comment
09/11/2010, <a href="#">R 1033/2009-4</a> , PEPE / bebe	The goods that were assessed to be reputed in Germany by the decision and order referred to only concern articles of skin and body care and children's cream. These articles are not identical to the earlier mark's goods in Class 3, <i>make-up products; nail treating products; namely nail lacquer and remover</i> . Therefore, the opponent did not prove reputation for the earlier German mark in the relevant territories (para. 31).

Where the earlier mark is registered for a wide range of goods and services targeting different kinds of public, it will be necessary to assess reputation separately for each category of goods. In such cases the earlier mark may not have a reputation for all of them, as it may not have been used at all for some of the goods, whereas for others it may not have reached the degree of knowledge necessary for the application of [Article 8\(5\) EUTMR](#).

Hence, if the evidence shows that the earlier mark enjoys a **partial reputation**, that is, the reputation only covers some of the goods or services for which it is registered, it is only to that extent that this mark may be protected under [Article 8\(5\) EUTMR](#). Consequently, it is **only these goods** that may be taken into account for the purposes of the examination.

Case No	Comment
14/06/2011, <a href="#">R 1588/2009-4</a> , PINEAPPLE / APPLE	The Board concluded that the enhanced distinctiveness and reputation of the earlier marks did not concern the opponent's G&S, which were considered to be identical or similar to the contested G&S. For these G&S no enhanced distinctiveness or reputation was proven, with the exception of <i>computer software</i> in Class 9 (para. 43).
10/12/2009, <a href="#">R 1466/2008-2</a> & <a href="#">R 1565/2008-2</a> , COMMERZBANK ARENA / ARENA et al.	The evidence submitted sufficiently demonstrated that the 'ARENA' brand was known by a significant part of the relevant public. However, the evidence did not include any relevant information that could allow the level of brand awareness of the 'ARENA' brand in sectors other than <i>swimwear and swimming articles</i> to be determined (paras 58 and 60).

#### 3.1.2.4 Relevant territory

According to [Article 8\(5\) EUTMR](#), the **relevant territory** for establishing the reputation of the earlier mark is the territory of protection: the earlier mark must **have a reputation in the territory where it is registered**. Therefore, for national marks the relevant territory is the Member State concerned, whereas for EUTMs the relevant territory is the European Union.

In *Chevy (General Motors)*, the Court stated that a national trade mark cannot be required to have a reputation throughout the entire territory of the Member State concerned. It is sufficient if reputation exists in a substantial part of that territory. For the Benelux territory in particular, the Court held that a substantial part thereof may consist



of part of one of the Benelux countries (14/09/1999, [C-375/97](#), Chevy, EU:C:1999:408, § 28-29).

The Court has clarified that, for an earlier European Union trade mark, reputation throughout the territory of a single Member State may suffice.

Case No	Comment
06/10/2009, <a href="#">C-301/07</a> , Pago, EU:C:2009:611	The case concerned a European Union trade mark with a reputation throughout Austria. The Court indicated that a European Union trade mark must be known in a substantial part of the EU by a significant part of the public concerned by the goods or services covered by that trade mark. In view of the facts of the particular case, the territory of the Member State in question (Austria) was considered to constitute a substantial part of the territory of the EU (paras 29 and 30).

In general, however, when evaluating whether the part of the territory in question is a substantial one, account must be taken both of the size of the geographical area concerned and of the proportion of the overall population living there, since both these criteria may affect the overall significance of the specific territory.

Case No	Comment
21/08/2009, <a href="#">R 1283/2006-4</a> , RANCHO PANCHO (fig.) / EL RANCHO	Although the evidence submitted showed use of the mark in 17 restaurants in France in 2002, this figure was considered rather low for a country of 65 million inhabitants. Therefore, the reputation was not proven (para. 22).

Opponents often indicate in the notice of opposition that the earlier mark has a reputation in an area that extends beyond the territory of protection (e.g. a pan-European reputation is alleged for a national mark). In such a case the opponent's claim must be examined for the territory of protection only.

Similarly, the **evidence submitted must specifically concern the relevant territory**. For example, if the evidence relates to Japan, or to undefined regions, it will not be able to prove reputation in the EU or in a Member State. Therefore, figures concerning sales in the EU as a whole, or worldwide sales, are not appropriate for showing reputation in a specific Member State, if the relevant data are not broken down by territory. In other words, a 'wider' reputation must also be specifically proven for the relevant territory if it is to be taken into account.

Case No	Comment
22/03/2011, <a href="#">R 1718/2008-1</a> , LINGLONG / LL (fig.) et al.	Most of the documents submitted related to countries outside the European Union, mainly China, the opponent's home country, and other Asian countries. Consequently, the opponent cannot successfully claim to hold a well-known mark in the EU (para. 53).
14/06/2010, <a href="#">R 1795/2008-4</a> , ZAPPER-CLICK, (appeal dismissed in 03/10/2012, <a href="#">T-360/10</a> , ZAPPER-CLICK, EU:T:2012:517)	The respondent maintained in the notice of cancellation that reputation was claimed for the territory of the UK. However, the international registration only designated Spain, France and Portugal and, therefore, did not extend to the territory of the UK. In addition, the respondent did not file any evidence of a reputation in the Member States designated by the international registration (para. 45).

However, where reputation is claimed as extending beyond the territory of protection and there is evidence to this effect, this must be taken into account because it may reinforce the finding of reputation in the territory of protection.

### 3.1.2.5 Relevant point in time

The opponent must show that the earlier mark had acquired a reputation by the **filing date** of the contested EUTM application, taking account, where appropriate, of any **priority** validly claimed.

In addition, the reputation of the earlier mark must subsist until the decision on the opposition is taken. However, in principle it will be sufficient for the opponent to show that its mark already had a reputation on the filing/priority date of the EUTM application, while any subsequent **loss of reputation** is for the applicant to claim and prove. In practice, such an occurrence will be rather exceptional, since it presupposes a dramatic change of market conditions over a relatively short period of time.

Where the opposition is based on an **earlier application**, there is no formal obstacle for the application of [Article 8\(5\) EUTMR](#), which encompasses earlier applications by reference to [Article 8\(2\) EUTMR](#). Although, in most cases, the earlier application will not have acquired sufficient reputation in so short a time, it cannot be *a priori* excluded that a sufficient degree of reputation may be achieved in an exceptionally short period. In addition, the application may be for a mark that was already in use long before the application was filed and has therefore had sufficient time to acquire a reputation. In any event, as the effects of registration are retroactive, the applicability of [Article 8\(5\) EUTMR](#) to earlier applications cannot be regarded as a deviation from the rule that [Article 8\(5\) EUTMR](#) only applies to earlier registrations, as concluded in [paragraph 2.1](#).

In general, the **closer to the relevant date** the evidence is, the **easier** it will be to assume that the earlier mark had **acquired reputation** at that time. The evidential value of a particular document is likely to vary depending on how close the period covered is to the filing date. Evidence of reputation with regard to a later point in time than the relevant date might nevertheless allow conclusions to be drawn as to the earlier mark's reputation at the relevant date (27/01/2004, [C-259/02](#), Laboratoire de la mer, EU:C:2004:50, § 31; 17/04/2008, [C-108/07 P](#), Ferro, EU:C:2008:234, § 53; 15/12/2005, [T-262/04](#), Briquet à Pierre, EU:T:2005:463, § 82).

For this reason, the materials submitted with a view to proving reputation must be dated, or at least **clearly indicate when** the facts attested therein took place. Consequently, undated documents, or documents bearing a date added afterwards (e.g. hand-written dates on printed documents), are not appropriate for giving reliable information about the material time.

Case No	Comment
15/03/2010, <a href="#">R 55/2009-2</a> , BRAVIA / BRAVIA	The evidence showed that the mark 'BRAVIA/ BRAVIA' was used for LCD televisions in Austria, the Czech Republic, France, Germany, Hungary, Italy, the Netherlands, Poland, Portugal, Slovakia and Turkey. However, none of the documents were dated. The opponent failed to submit any information regarding duration. Therefore, the evidence, taken as whole, was insufficient to prove reputation in the European Union (paras 27 and 28).
09/11/2010, <a href="#">R 1033/2009-4</a> , PEPE / bebe	In the Board's view, a judgment from 1972 was not able to prove enhanced distinctiveness at the time of filing the mark, that is, 20/10/2006. Furthermore, 'it follows from the decision of the [Court] [21/04/2005, <a href="#">T-164/03</a> , monBeBé, EU:T:2005:140] that the reputation of the earlier mark has been assessed as from 13 June 1996, i.e. more than ten years before the reputation date to be taken into consideration' (para. 31).

If the **period** between the latest evidence of use and the filing of the EUTM application is quite **significant**, the relevance of the evidence should be carefully assessed by reference to the kind of goods and services concerned. This is because changes in consumer habits and perceptions may take some time to happen, usually depending on the particular market involved.

For instance, the clothing market is strongly tied to yearly seasons and to the different collections presented every quarter. This will have to be taken into account in assessing a possible loss of reputation in this particular field. Likewise, the market for

internet providers and e-commerce companies is very competitive and undergoes rapid growth, as well as rapid demise, which means that reputation in this area may be diluted faster than in other market sectors.

Case No	Comment
17/12/2010, <a href="#">R 883/2009-4</a> , MUSTANG / MUSTANG CALZADOS (fig.)	The appellant failed to prove that its earlier mark was already well known on the application date of the contested mark. The certificates regarding the reputation of the 'Mustang designation' refer neither to the 'Calzados Mustang' figurative mark asserted by the applicant nor to the time when reputation must be determined (para. 28).

A similar question arises in the case of **evidence that post-dates the filing date** of the EUTM application. Even though such evidence will not usually be sufficient on its own to prove that the mark had acquired a reputation when the EUTM was filed, it is not appropriate to reject it as irrelevant either. Given that reputation is usually built up over a period of years and cannot simply be switched on and off, and that certain kinds of evidence (e.g. opinion polls, affidavits) are not necessarily available before the relevant date, as they are usually prepared only after the dispute arises, such evidence must be evaluated on the basis of its contents **and in conjunction with the rest of the evidence**. For example, an opinion poll conducted after the material time but showing a sufficiently high degree of recognition might be sufficient to prove that the mark had acquired a reputation on the relevant date if it is also shown that the market conditions have not changed (e.g. the same levels of sales and advertising expenditure were maintained before the opinion poll was carried out).

Case No	Comment
16/12/2010, <a href="#">T-345/08</a> & <a href="#">T-357/08</a> , Botolist / Botocyl, confirmed 10/05/2012, <a href="#">C-100/11 P</a> , EU:C:2012:285	Although the reputation of an earlier mark must be established at the filing date of the contested mark, documents bearing a later date cannot be denied evidential value if they enable conclusions to be drawn with regard to the situation as it was on that date (para. 52).

05/10/2020, <a href="#">T-51/19</a> , apiheal (fig.) / APIRETAL, EU:T:2020:468	Even if some documents submitted to prove the reputation of the earlier mark bear a date which is e.g. 5 years earlier than the filing date of the contested EUTM, this fact does not deprive such documents of their evidential value. It cannot automatically be ruled out that a document drawn up some time before or after the relevant date may contain useful information since the reputation of a trade mark is, in general, acquired progressively (para. 112).
--	---

The possibility cannot automatically be ruled out that a document drawn up some time before or after that date may contain useful information in view of the fact that the reputation of a trade mark is, in general, acquired progressively. The evidential value of such a document is likely to vary depending on how close the period covered is to the filing date (27/01/2004, [C-259/02](#), Laboratoire de la mer, EU:C:2004:50, § 31; 17/04/2008, [C-108/07 P](#), Ferro, EU:C:2008:234, § 53; 15/12/2005, [T-262/04](#), Briquet à Pierre, EU:T:2005:463, § 82).

Case No	Comment
16/12/2010, <a href="#">T-345/08</a> & <a href="#">T-357/08</a> , Botolist / Botocyl, confirmed by 10/05/2012, <a href="#">C-100/11 P</a> , EU:C:2012:285	The press articles submitted proved that there was significant media coverage of the products marketed under the trade mark BOTOX on the filing date of the disputed marks (para. 53).

### 3.1.2.6 Reputation acquired as part of another mark

Reputation proven for a complex sign refers to that sign as such and not a particular element alone. As an example, the reputation acquired by a figurative mark may, but will not automatically, benefit a word mark with which it is subsequently used.

To establish the reputation of a trade mark on the basis of evidence relating to the use and well-known nature of a different trade mark, the former must be included in the latter and play therein 'a predominant or even significant role' (21/05/2015, [T-55/13](#), F1H20 / F1 et al., EU:T:2015:309 § 47). When the earlier mark has been used as part of another mark, it is incumbent on the opponent to prove that the earlier mark has independently acquired a reputation (12/02/2015, [T-505/12](#), B, EU:T:2015:95, § 121). The examples below give guidance.

Case No	Comment
---------	---------

<p>17/03/2015, <a href="#">T-611/11</a>, Manea Spa, EU:T:2015:152 (Relevant Classes 3, 24, 25, 43 and 44)</p>	<p>The word mark 'Spa' was used as part of another registration combining the word element with the logo of a pantomime character, as reproduced here</p>  <p>. The word element occupies a central position in the complex sign, and therefore plays a 'distinct and predominant' role.</p>
---	---

Case No	Comment
<p>17/02/2011, <a href="#">T-10/09</a>, F1-Live, EU:T:2011:45; 24/05/2012, <a href="#">C-196/11 P</a>, F1-Live, EU:C:2012:314 (Relevant Classes 16, 38 and 41) and 21/05/2005, <a href="#">T-55/13</a>, F1H20 / F1 et al., EU:T:2015:309 (Relevant Classes 9, 25, 38 and 41)</p>	<p>On the other hand, in case <a href="#">T-10/09</a> it was held that the evidence of reputation referred to the earlier figurative mark 'F1 Formula 1'</p>  <p>and not to the earlier word marks, 'F1'. Without its particular logotype the text 'Formula 1' and its abbreviation 'F1' are perceived as descriptive elements for a category of racing cars or races involving those cars. The reputation was not proven for the word marks (see paras 53, 54 and 67).</p> <p>In case <a href="#">T-55/13</a>, the Court held that the reputation with which the complex sign 'F1' is associated did not benefit the word element alone, which does not play a 'predominant or even significant' role in the earlier figurative mark (see para. 47).</p>

Case No	Comment
---------	---------

<p>12/02/2015, <a href="#">T-76/13</a>, QUARTODIMIGLIO QM, EU:T:2015:94</p>	<p>The same conclusion applies to a ‘winged hourglass’ figurative element used in a complex mark in association with the word ‘Longines’</p>  <p>. The figurative element remains clearly ancillary and in the background in the overall impression conveyed by the complex mark (paras 104 to 106). The Court found that the opponent had failed to submit opinion polls showing the recognition of the ‘winged hourglass’ logo independently of the word element, and the use of this figurative element alone in a limited number of documents was found insufficient from both a quantitative and qualitative point of view (paras 91 to 93 and para. 112).</p>
---	---

Case No	Comment
<p>27/06/2019, <a href="#">T-334/18</a>, ANA DE ALTUN (fig.) / ANNA (fig.) et al., EU:T:2019:451</p>	<p>The evidence showed reputation of the earlier word mark ‘ANNA DE CODORNIU’, but that evidence did not prove that the earlier figurative mark</p>  <p>was reputed on its own (paras 38-39). While a mark may also acquire reputation as a result of its use under a different form, in particular under the form of another registered mark, this is dependent on the condition that the relevant public continues to perceive the goods as originating from the same undertaking (para. 45).</p>

### 3.1.3 Assessment of reputation — relevant factors

Apart from indicating that ‘[i]t cannot be inferred from either the letter or the spirit of [Article 5\(2\) of the \[TMD\]](#) that the trade mark must be known by a **given percentage** of the public’, the Court also held that **all the relevant facts** must be considered when assessing the reputation of the earlier mark, ‘**in particular the market share** held by the trade mark, the **intensity, geographical extent** and **duration** of its use, and the

**size of investment** made by the undertaking in promoting it' (14/09/1999, [C-375/97](#), Chevy, EU:C:1999:408, § 25, 27).

If these two statements are taken together, it follows that the level of knowledge required for the purposes of [Article 8\(5\) EUTMR](#) cannot be defined in the abstract, but should be evaluated on a **case-by-case** basis, taking into account **not only the degree of awareness of the mark, but also any other fact relevant to the specific case**, that is, any factor capable of giving information about the performance of the mark in the market.

The list of factors to be taken into consideration in order to ascertain the reputation of an earlier mark (such as the market share held by the trade mark, the intensity, geographical extent and duration of its use, and the amount spent by the undertaking in promoting it) only serve as examples. The conclusion that the mark enjoys reputation does not necessarily have to be reached on the basis of indications regarding all those factors.

Case No	Comment
10/05/2007, <a href="#">T-47/06</a> , Nasdaq, EU:T:2007:131	<p>The opponent provided detailed evidence relating to the intensity, geographical extent and duration of use of its trade mark, Nasdaq, as well as to the amount spent in promoting it, demonstrating that it was known by a significant part of the relevant public. The Court considered that the fact that it did not produce figures regarding market share did not call this finding into question (para. 51).</p> <p>The Court concluded that, first, the factors to be taken into consideration in order to ascertain the reputation of an earlier mark only serve as examples, as all relevant evidence in the case must be taken into consideration and, second, the other detailed and verifiable evidence produced by the intervener is already sufficient in itself to conclusively prove the reputation of its mark, Nasdaq (para. 52).</p>

Moreover, the relevant factors should be assessed with a view not only to establishing the degree of recognition of the mark amongst the relevant public, but also to ascertaining whether the **other requirements** related to reputation are fulfilled, for example, whether the alleged reputation covers a significant part of the territory concerned or whether the reputation had indeed been acquired by the filing/priority date of the contested EUTM application.

The same kind of test is applied to ascertain whether the trade mark has acquired **enhanced distinctiveness** through use for the purposes of [Article 8\(1\)\(b\) EUTMR](#), or



whether the mark is **well known** within the meaning of Article 6*bis* of the Paris Convention, since what has to be proven in all these cases is in substance the same, namely the degree to which the mark is known by the relevant public, without prejudice to the threshold required in each case.

### 3.1.3.1 Trade mark awareness

The statement of the Court that it is not necessary for the mark to be 'known by a given percentage of the public', cannot be taken in itself as meaning that figures of trade mark awareness are irrelevant, or should be given a lower probative value, when assessing reputation. It only implies that percentages of awareness defined in the abstract may not be appropriate for all cases and that, consequently, it is **not possible to fix a priori a generally applicable threshold of recognition** beyond which it should be assumed that the mark is reputed (04/05/1999, [C-108/97](#) & [C-109/97](#), Chiemsee, EU:C:1999:230, § 52; 22/06/1999, [C-342/97](#), Lloyd Schuhfabrik, EU:C:1999:323, § 24; 16/11/2011, [T-500/10](#), Doorsa, EU:T:2011:679, § 52).

Therefore, even though not expressly listed by the Court among the factors to be taken into account for assessing reputation, the **degree of recognition** of the mark amongst the relevant public is **directly relevant** and can be particularly helpful in evaluating whether the mark is sufficiently known for the purposes of [Article 8\(5\) EUTMR](#), provided of course that the method of its calculation is reliable.

As a rule, the **higher the percentage** of trade mark awareness, the **easier** it will be to accept that the **mark has a reputation**. However, in the absence of a clear threshold, only if the evidence shows a **high degree** of trade mark awareness, will percentages of recognition be **persuasive**. Percentages alone are not conclusive. Rather, as explained before, reputation has to be evaluated by making an overall assessment of all the factors relevant to the case. The higher the degree of awareness, the less additional evidence may be required to prove reputation and vice versa.

Case No	Comment
---------	---------

<p>24/02/2010, <a href="#">R 765/2009-1</a>, Bob the Builder (fig.) / BOB et al.</p>	<p>The evidence submitted proved that the earlier mark enjoyed a very significant reputation in Sweden for <i>jellies, jams, fruit stews, fruit drinks, concentrates for production of drinks and juice</i>. According to the survey conducted by TNS Gallup, spontaneous awareness (answers by telephone to the question ‘What brands for — ‘the relevant group of products is mentioned’ — have you heard about or do you know about?’) of the trade mark ‘BOB’ varied between 25 % and 71 %, depending on the goods: <i>apple sauces, jams, marmalades, soft drinks, fruit drinks and fruit juices</i>. Supported awareness (answers to a questionnaire showing the products bearing the mark) varied between 49 % and 90 %, depending on the goods. Furthermore, the market share for 2001 to 2006 averaged 30-35 % in the above product groups (para. 34).</p>
--	---

Where the evidence shows that the mark only enjoys a **lesser degree of recognition**, it should not automatically be assumed that the mark is reputed; this means that, most of the time, **mere percentages will not be conclusive** in themselves. In such cases, only if evidence of awareness is coupled with sufficient indications of the overall performance of the mark in the market will it be possible to evaluate with a reasonable degree of certainty whether the mark is known by a significant part of the relevant public.

### 3.1.3.2 Market share

The **market share** enjoyed by the goods offered or sold under the mark and the **position** it occupies in the market are valuable indications for assessing reputation, as they both serve to indicate the **percentage of the relevant public that actually buys** the goods and to measure the success of the mark against competing goods.

Market share is defined as the **percentage of total sales** obtained by a brand in a particular sector of the market. When defining the relevant market sector, the goods and services for which the **mark has been used** must be taken into account. If the scope of such goods and services is narrower than those for which the mark is registered, a situation of partial reputation arises, similar to the one where the mark is registered for a variety of goods, but has acquired a reputation only for part of them. This means that, in such a case, only **the goods and services for which the mark has actually been used and acquired a reputation will** be taken into account for the purposes of the examination.

Therefore, a very **substantial market share**, or a **leader position** in the market, will usually be a **strong indication of reputation**, especially if combined with a reasonably high degree of trade mark awareness. Conversely, a **small market share** will in most cases be an **indication against reputation**, unless there are other factors that suffice on their own to support such a claim.

Case No	Comment
16/12/2010, <a href="#">T-345/08</a> & <a href="#">T-357/08</a> , Botolist / Botocyl, confirmed 10/05/2012, <a href="#">C-100/11 P</a> , EU:C:2012:285	'... the size of the <b>market share of BOTOX in the United Kingdom, 74.3 % in 2003</b> , like the degree of awareness of the trade mark of 75 % among the specialised public accustomed to pharmaceutical treatments against wrinkles, is sufficient to substantiate the existence of a considerable degree of recognition on the market' (para. 76).
13/12/2004, <a href="#">T-08/03</a> , Emilio Pucci, EU:T:2004:358	The Court considered that the opponent failed to prove the enhanced distinctiveness or reputation of its earlier trade marks, since the evidence submitted (advertisements, seven letters from a number of advertising directors and a video cassette) did not include adequately substantiated or verifiable objective evidence to make it possible <b>to assess the market share</b> held by the marks Emilio Pucci in Spain, how intensive, geographically widespread and long-standing use of the marks had been, or the amount invested by the undertaking in promoting them (para. 73).

Another reason why a **moderate market share will not always be conclusive against reputation** is that the percentage of the public that in reality knows the mark may be much higher than the number of actual buyers of the relevant goods. This would be the case, for example, for goods that are normally used by more than one user (e.g. family magazines or newspapers) (06/07/2012, [T-60/10](#), Royal Shakespeare, EU:T:2012:348, § 35-36; 10/05/2007, [T-47/06](#), Nasdaq, EU:T:2007:131, § 47, 51) or for luxury goods, which many may know, but few can buy (e.g. a high percentage of European consumers know the trade mark 'Ferrari' for cars, but only few own one). For this reason, the market share proved by the evidence should be assessed taking into account the particularities of the specific market.

Case No	Comment

<p>29/05/2012, <a href="#">R 1659/2011-2</a>, KENZO / KENZO</p>	<p>KENZO identifies, in the eyes of the European public, a pre-eminent provider of recognised fashion and luxury items in the form of perfumes, cosmetics and clothing. The relevant public however was considered to be the general public (para. 29).</p>
---	---

In certain cases it will **not be easy to define the market share** of the earlier mark, for example when the exact size of the relevant market cannot be measured accurately, owing to peculiarities of the goods or services concerned.

Case No	Comment
<p>12/01/2011, <a href="#">R 446/2010-1</a>, TURBOMANIA / TURBOMANIA</p>	<p>The limited presence of the product on the market by no means prevented it from becoming well known by the relevant public. The evidence clearly showed that the trade mark appeared continuously in specialist magazines for the market from December 2003 to March 2007 (the date of the EUTM application). That meant that the public targeted by the magazines had constant, ongoing exposure to the opponent's trade mark over a long period covering more than 3 years prior to the relevant date. Such a huge presence in the press specifically targeting the relevant public was more than sufficient evidence that the relevant public was aware of the trade mark (para. 31).</p>

In such cases, **other similar indications** may be relevant, such as TV audience ratings, as in the case of motor racing and other sporting or cultural events.

Case No	Comment
---------	---------

10/05/2007, <a href="#">T-47/06</a> , Nasdaq, EU:T:2007:131	The opponent submitted evidence showing that the mark Nasdaq appeared almost daily, particularly with reference to the Nasdaq indices, in many <b>newspapers</b> and on many <b>television channels</b> that can be read/viewed throughout Europe. The opponent also submitted evidence of <b>substantial investments in advertising</b> . The Court found reputation proven, even though the opponent did not submit any market share figures (paras 47 to 52).
---	--

### 3.1.3.3 Intensity of use

The intensity of use of a mark may be demonstrated by **sales volumes** (i.e. the number of units sold) and **turnover** (i.e. the total value of those sales) attained by the opponent for goods bearing the mark. Usually, the relevant figures correspond to sales in 1 year, but there may be cases where the time unit used is different.

Case No	Comment
15/09/2011, <a href="#">R 2100/2010-1</a> , SEXIALIS / CIALIS et al.	The documents submitted (press articles, sales figures, surveys) showed that the earlier sign, CIALIS, was intensively used before the filing date of the EUTM application, that the products under the mark CIALIS were marketed in several Member States where they enjoyed a consolidated position among the leading brands, and that there was a high degree of recognition when compared with the market leader Viagra. Large and constantly growing market share and sales numbers also showed 'the vast expansion of CIALIS' (para. 55).

In evaluating the importance of a given turnover or sales volume, account should be taken of **how large the relevant market is in terms of population**, as this has a bearing on the number of potential purchasers of the products in question. For example, the relative value of the same number of sales will be much bigger, for example, in Luxembourg than in Germany.

Moreover, whether or not a given sales volume or turnover is substantial will depend on the **kind of product** concerned. For example, it is much easier to achieve a high sales volume for everyday mass consumption goods than for luxury or durable products that are bought rarely, without this meaning that in the former case more consumers have come into contact with the mark, as it is likely that the same person has bought the

same product more than once. It follows that the **kind, value and durability** of the goods and services in question should be taken into consideration in determining the significance of a given sales volume or turnover.

Turnover and sales figures will be more useful as **indirect indications**, to be assessed in conjunction with the rest of the evidence, than as direct proof of reputation. In particular, such indications can be especially helpful for **completing the information given by percentages** as regards market share and awareness, by giving a more **realistic impression** of the market. For example, they may reveal a very large amount of sales behind a not-so-impressive market share, which may be useful in assessing reputation in the case of competitive markets, where it is in general more difficult for a single brand to account for a substantial portion of the overall sales.

By contrast, where the market share of the products for which the mark is used is not given separately, it will not be possible to determine whether a given turnover corresponds to a substantial presence in the market or not, unless the opponent also submits evidence showing the **overall size of the relevant market in monetary terms**, so that the opponent's percentage of the market can be inferred.

Case No	Comment
21/04/2010, <a href="#">R 1054/2007-4</a> , MANDARINO (fig.) / MANDARINA DUCK (fig.)	Reputation was not sufficiently proven, in particular because none of the documents referred to recognition of the earlier trade mark by the relevant end consumers. Nor was any evidence about the market share of the opponent's goods submitted. Information about market share is particularly important in the sector in which the opponent had its core business ( <i>handbags, transport items, accessories and clothing</i> ), as it is 'a quite atomized and competitive sector' and 'there are many different competitors and designers in that product range' (paras 59 to 61).

This does not mean that the importance of turnover figures or volume of sales should be underestimated, as both are significant indications of **the number of consumers** that are expected to have encountered the mark. Therefore, it **cannot be excluded** that a **substantial** amount of turnover or sales volume may, in certain cases, be **decisive** for a finding of reputation, either alone, or in conjunction with very little other evidence.

Case No	Comment
12/01/2011, <a href="#">R 445/2010-1</a> , FLATZ / FLATZ	Although, for reasons of <i>force majeure</i> , it was not possible for the earlier trade mark to become well known by traditional methods, that is, through sales of the product, it did become extremely well known as a result of promotional activities, through the trade mark being extensively, continually and constantly publicised in the specialist press and at sector fairs, thereby reaching virtually the whole of the three relevant sectors of the public. The limited presence of the product on the market by no means prevented it from becoming well known by the relevant public that, on the relevant date, FLATZ was the trade mark with which the opponent identified its <i>electronic bingo machines</i> (paras 41, 42, 50 and 51).
10/12/2009, <a href="#">R 1466/2008-2</a> & <a href="#">R 1565/2008-2</a> , COMMERZBANK ARENA / ARENA ET AL.	The lack of figures regarding market share held by the trade mark ARENA in the relevant countries was not in itself capable of calling the finding of reputation into question. First, the list of factors to be taken into consideration in order to ascertain the reputation of an earlier mark only serves to illustrate examples, as all the relevant evidence in the case must be taken into consideration and, second, the other detailed and verifiable evidence submitted by the opponent is already sufficient in itself to prove conclusively the substantial degree of recognition of the ARENA mark amongst the relevant public (para. 59).

However, as this would deviate from the rule that reputation has to be evaluated by making an overall assessment of all factors relevant to the case, findings of reputation based almost exclusively on such figures should be generally avoided, or at least confined to exceptional cases in which such a finding would really be justified.

#### 3.1.3.4 Geographical extent of use

Indications of the territorial extent of use are mainly useful for determining whether the alleged reputation is **widespread enough to cover a substantial part** of the relevant territory, within the sense given in [paragraph 3.1](#) above. In this assessment, account should be taken of the population density in the areas concerned, as the critical criterion is the proportion of consumers knowing the mark, rather than the size of the geographical area as such. Similarly, what is important is public awareness of the mark

rather than availability of the goods or services. A mark may, therefore, have a territorially widespread reputation on the basis of advertising, promotion, media reports, etc.

In general, the more widespread the use, the easier it will be to conclude that the mark has passed the required threshold, whereas any indication showing use beyond a substantial part of the relevant territory will be a positive indicator of reputation. Conversely, a very limited amount of use in the relevant territory will be a strong indication against reputation, as for example where the vast majority of the goods are exported to a third jurisdiction in sealed containers directly from their place of production.

Case No	Comment
26/05/2011, <a href="#">R 966/2010-1</a> , ERT (fig.) / ERT (fig.)	If the earlier mark were so well known in the 27 Member States of the EU for TV broadcasting and magazines, it should have been easy for the opponent to provide information about 'the reach of the mark' just before 2008, when the EUTM application was filed. The magazine sales figures did not cover the right period. Nor did the documents submitted give any indication of the extent to which the public was aware of the mark (paras 16 and 18).

However, evidence of actual use in the relevant territory should not be regarded as a necessary condition for the acquisition of reputation, as what matters most is knowledge of the mark and not how it was acquired.

Such knowledge may be generated by, for example, intensive advertising prior to the launching of a new product or, in the case of high levels of cross-border shopping, it may be fuelled by a significant price difference in the respective markets, a phenomenon often referred to as '**territorial spill-over**' of reputation from one territory to another. However, when it is claimed that such circumstances have occurred, the corresponding evidence must demonstrate this. For example, it cannot be assumed, merely because of the principle of free trade in the European Union, that goods put on the market in Member State X have also penetrated the market of Member State Y in significant quantities.

### 3.1.3.5 Duration of use

Indications of the duration of use are particularly useful for determining the **longevity** of the mark. The longer the mark has been used in the market, the larger will be the number of consumers that are likely to have encountered it, and the more likely it is that such consumers will have encountered the mark more than once. For example, a



market presence of 45, 50 or 100-plus years is considered a strong indication of reputation.

Case No	Comment
10/12/2009, <a href="#">R_1466/2008-2</a> & <a href="#">R_1565/2008-2</a> , COMMERZBANK ARENA / ARENA ET AL.	The evidence submitted showed a particularly impressive duration of use (over 30 years) and geographical extent of use (over seventy-five countries worldwide, including the Member States concerned) for the ARENA brand (para. 55).
29/03/2012, <a href="#">T-369/10</a> , Beatle, EU:T:2012:177 (appeal dismissed in 14/05/2013, <a href="#">C-294/12 P</a> , EU:C:2013:300)	The Beatles group was considered to be a group with an exceptional reputation, lasting for more than 40 years (para. 36).

The duration of use of the mark should not be inferred by mere reference to the term of its registration. Registration and use do not necessarily coincide, as the mark may have been put to actual use either before or after it was filed.

In the end, the decisive element is whether the earlier mark had a reputation at the time of filing of the contested application. Whether that reputation also existed at some earlier point in time is legally irrelevant. Therefore, evidence of **continuous use up to the filing date** of the application will be a positive indicator of reputation.

By contrast, if **use of the mark was suspended** over a significant period, or if the period between the latest evidence of use and the filing of the EUTM application is quite long, it will be more difficult to conclude that the mark's reputation survived the interruption of use, or that it subsisted until the filing date of the application (see [paragraph 3.1.2.5](#)).

#### 3.1.3.6 Promotional activities

The **nature** and **scale of the promotional activities** undertaken by the opponent are useful indications when assessing the reputation of the mark, to the extent that these activities were undertaken to build up a brand image and enhance trade mark awareness among the public. Therefore, **a long, intensive and widespread** promotional campaign may be a **strong indication** that the mark has acquired a reputation among the potential or actual purchasers of the goods in question, and that it may actually have become known beyond the circle of the actual purchasers of those goods.

Case No	Comment
10/05/2012, <a href="#">C-100/11 P</a> , Botolist / Botocyl	Evidence of the promotion of BOTOX in English in the scientific and general-interest press was sufficient to establish the mark's reputation amongst both the general public and health-care professionals (paras 65 and 66).
12/01/2011, <a href="#">R 445/2010-1</a> , FLATZ / FLATZ	Although, for reasons of <i>force majeure</i> , it was not possible for the earlier trade mark to become well known by traditional methods, that is, through sales of the product, it did become extremely well known as a result of promotional activities, through the trade mark being extensively, continually and constantly publicised in the specialist press and at sector fairs, thereby reaching virtually the whole of the three relevant sectors of the public. The limited presence of the product on the market by no means prevented it from becoming well known by the relevant public that, on the relevant date, FLATZ was the trade mark with which the opponent identified its <i>electronic bingo machines</i> (paras 41, 42, 50 and 51).
29/05/2012, <a href="#">R 1659/2011-2</a> , KENZO / KENZO (confirmed, 22/01/2015, <a href="#">T-393/12</a> , EU:T:2015:45, § 57)	The opponent's goods, <i>cosmetics, perfumes and clothing</i> , have been advertised and articles have been written about them in many of the world's leading fashion-related lifestyle magazines, and in some of Europe's leading mainstream periodicals. In line with the case-law, the reputation of KENZO for the said goods is confirmed (para. 29).

Even though it cannot be ruled out that a mark acquires a reputation before any actual use, promotional activities will usually not be sufficient on their own for establishing that the earlier mark has indeed acquired a reputation (see [paragraph 3.1.3.4](#) above). For example, it will be difficult to prove knowledge amongst a significant part of the public exclusively by reference to promotion or advertising, carried out as preparatory acts for the launching of a new product, as the actual impact of publicity on the perception of the public will be difficult to measure without reference to sales. In such situations, the only means of evidence available to the opponent are opinion polls and similar instruments, the probative value of which may vary depending on the reliability of the method used, the size of the statistical sample, etc. (for the probative value of opinion polls, see [paragraph 3.1.4](#) below).

The impact of the opponent's promotional activities may be shown either **directly**, by reference to the **amount of promotional expenditure**, or **indirectly**, by way of

inference from the **nature of the promotional strategy** adopted by the opponent and **the kind of medium used** for advertising the mark.

For example, advertising on a nationwide TV channel or in a prestigious periodical should be given more weight than campaigns of a regional or local scope, especially if coupled with high audience or circulation figures. Likewise, the sponsoring of prestigious athletic or cultural events may be a further indication of intensive promotion, as such schemes often involve a considerable investment.

Case No	Comment
22/01/2010, <a href="#">R 1673/2008-2</a> , FIESTA / FIESTA (fig.) ET AL.	It is apparent from Ferrero's various advertising campaigns on Italian television (including Rai) that the earlier mark was widely exposed to viewers in 2005 and 2006. Many of these spots appear to have been broadcast at peak viewing times (e.g. during Formula 1 Grand Prix coverage) (para. 41).

Furthermore, the **contents of the advertising strategy** chosen by the opponent can be useful for revealing the **kind of image** the opponent is trying to create for its brand. This may be of particular importance when assessing the possibility of detriment to, or unfair advantage being taken of, a particular image allegedly conveyed by the mark, since the existence and contents of such an image must be abundantly clear from the evidence submitted by the opponent (see [paragraph 3.4](#) below).

Case No	Comment
11/01/2011, <a href="#">R 306/2010-4</a> , CARRERA / CARRERA, (under appeal, 27/11/2014, <a href="#">T-173/11</a> , Carrera / CARRERA, EU:T:2014:1001)	The opponent's trade mark is not only known per se but, due to the high price of sports cars and the opponent's intensive expenditure on advertising, and against the background of its successes in racing, the public associates it with an image of luxury, high technology and high performance (para. 31).

### 3.1.3.7 Other factors

The factors listed above are only indicative. All the facts relevant to the particular case must be taken into consideration when assessing the reputation of the earlier mark (14/09/1999, [C-375/97](#), Chevy, EU:C:1999:408, § 27). Other factors may be found in case-law or in WIPO's Joint Recommendation. Therefore, depending on their relevance in each case, the following factors may be added: record of successful enforcement; number of registrations; certification and awards; and the value associated with the mark.

### Record of successful enforcement

Records of successful enforcement of a mark against dissimilar goods or services are important because they may demonstrate that, at least in relation to other traders, there is acceptance of protection against dissimilar goods or services.

Such records may consist of the successful prosecution of complaints outside the courts, such as the acceptance of cease and desist requests, delimitation agreements in trade mark cases, etc.

Furthermore, evidence showing that the reputation of the opponent's mark has been repeatedly recognised and protected against infringing acts by **decisions of judicial or administrative authorities** will be an important indication that the mark enjoys a reputation in the relevant territory, especially where such decisions are recent. That effect may be reinforced when there is a substantial number of decisions of this kind (on the probative value of decisions, see [paragraph 3.1.4.4](#)). This factor is mentioned in Article 2(1)(b)(5) of WIPO's Joint Recommendation.

### Number of registrations

The **number** and **duration of registrations** and applications for the mark around Europe or the world is also relevant, but is in itself a weak indication of the degree of recognition of the sign by the relevant public. The fact that the opponent has many trade mark registrations and in many classes may indirectly attest to the international circulation of the brand, but cannot decisively prove a reputation in itself. This factor is mentioned in Article 2(1)(b)(4) of the WIPO Joint Recommendation, where the need for actual use is made clear: the duration and geographical area of any registrations, and/or any applications for registration, of the mark are relevant 'to the extent that they reflect use or recognition of the mark'.

### Certification and awards

Certification, awards, and similar public recognition instruments usually provide information about the history of the mark, or reveal certain quality aspects of the opponent's products, but as a rule they will not be sufficient in themselves to establish reputation and will be more useful as indirect indications. For example, the fact that the opponent has been a holder of a royal warrant for many years may perhaps show that the mark invoked is a traditional brand, but cannot give first-hand information about trade mark awareness. However, if the certification concerns facts that are related to the performance of the mark, its relevance will be much higher. This factor is mentioned by the Court in *Lloyd Schuhfabrik (Lloyd Schufabrik Meyer)* and *Chiemsee (Windsurfing Chiemsee)* in relation to the assessment of enhanced distinctiveness through use.

Case No	Comment
---------	---------

<p>14/06/2012, <a href="#">R 1637/2011-5</a>, made by APART since 1975 / Apart et al.</p>	<p>The new evidence submitted by the appellant and accepted by BoA shows that the earlier mark had consistently been granted a high brand rating as well as prizes in surveys carried out by specialised companies in Poland between 2005 and 2009 (para. 30). It was therefore considered that the appellant successfully proved reputation in Poland for jewellery, but did not prove reputation for the other goods and services covered by its earlier signs.</p>
---	---

### The value associated with the mark

The fact that a mark is solicited by third companies for reproduction on their products, either as a trade mark, or as mere decoration, is a strong indication that the mark possesses a high degree of attractiveness and an important economic value. Therefore, the extent to which the mark is exploited through **licensing, merchandising and sponsoring**, as well as the scale of the respective schemes, are useful indications in assessing reputation. This factor is mentioned in Article 2(1)(b)(6) of the WIPO Joint Recommendation.

#### 3.1.4 Proof of reputation

##### 3.1.4.1 Standard of proof

The opponent must submit evidence enabling the Office to reach the **positive conclusion** that the earlier mark has acquired a reputation in the relevant territory. The wording used in [Article 8\(5\) EUTMR](#) and [Article 7\(2\)\(f\) EUTMDR](#) is quite clear in this respect: the earlier mark deserves enlarged protection only if it ‘has a reputation’.

It follows that the **evidence must be clear and convincing**, in the sense that the opponent must clearly establish all the facts necessary to safely conclude that the mark is known by a significant part of the public. The reputation of the earlier mark must be established to the satisfaction of the Office and not merely assumed.

##### 3.1.4.2 Burden of proof

According to the second sentence of [Article 95\(1\) EUTMR](#), in *inter partes* proceedings the Office is restricted in its examination to the facts, evidence and arguments provided by the parties. Therefore, when assessing whether the earlier mark has a reputation, the Office **cannot take into account** facts known to it as a result of its own **private knowledge** of the market, **nor can it conduct an *ex officio* investigation**. In addition, [Article 7\(2\)\(f\) EUTMDR](#) provides that the burden of putting forward and proving the relevant facts lies with the opponent, by expressly requiring it to provide evidence attesting that the earlier mark has a reputation for the goods and services claimed.

Whether or not a mark passes the required reputation threshold is not in itself a pure question of fact, since it requires a legal evaluation of several factual indications. Therefore, reputation of a mark cannot be considered to be a well-known fact. In particular, qualitative aspects of the reputation, such as a specific image associated with the reputed mark, may only be assessed on the basis of specific pertinent evidence.

### 3.1.4.3 Evaluation of the evidence

The basic rules on the evaluation of evidence are also applicable here: the evidence should be assessed **as a whole**, that is, each indication should be weighed up against the others, with information confirmed by more than one source generally being considered more reliable than facts derived from isolated references. Indeed, the more independent, reliable and well-informed the source of the information is, the higher the probative value of the evidence will be.

Therefore, information **deriving directly from the opponent** is unlikely to be enough on its own, especially if it only consists of **opinions** and **estimates** instead of facts, or if it is of an **unofficial character** and lacks objective confirmation, as for example when the opponent submits internal memoranda or tables with data and figures of unknown origin.

Case No	Comment
29/04/2010, <a href="#">R 295/2009-4</a> , PG PROINGEC CONSULTORIA (fig.) / PROINTEC (fig.) et al.	The content of the documentation submitted does not clearly demonstrate that the earlier marks enjoy a reputation. The documentation emanates, in the main, from the respondent directly and contains information taken from its trade catalogues, its own advertising and documents downloaded from its website. There is insufficient documentation/information from third parties to reflect clearly and objectively what precisely the respondent's position on the market is. Reputation not proved (para. 26).

Case No	Comment
16/11/2011, <a href="#">T-500/10</a> , Doorsa, EU:T:2011:679	As regards documents in the case file that come from the company itself, the General Court has held that, to assess the evidential value of such a document, account should be taken first and foremost of the credibility of the account it contains. The General Court added that it is then necessary to take account, in particular, of the person from whom the document originates, the circumstances in which it came into being, the person to whom it was addressed and whether, prima facie, the documents appear sound and reliable (para. 49).

However, if such information is publicly available or has been compiled for official purposes and contains information and data that have been objectively verified, or reproduces statements made in public, its probative value is generally higher.

As regards its contents, the more indications the evidence gives about the various factors from which reputation may be inferred, the more relevant and conclusive it will be. In particular, evidence that, as a whole, gives **little or no quantitative data and information** will not be appropriate for providing indications about **vital factors**, such as trade mark awareness, market share and intensity of use and, consequently, will not be sufficient to support a finding of reputation.

#### 3.1.4.4 Means of evidence

The opponent may avail itself of all the means of evidence listed under [Article 97\(1\) EUTMR](#). In any event, the opponent is free to choose the form of evidence which it considers useful to submit (26/06/2019, [T-651/18](#), HAWKERS (fig.) / HAWKERS (fig.) et al., EU: T:2019:444 § 35).

The following means of evidence can be pertinent to prove reputation (this list does not reflect their relative importance or probative value):

1. sworn or affirmed statements
2. decisions of courts or administrative authorities
3. decisions of the Office
4. opinion polls and market surveys
5. audits and inspections
6. certification and awards
7. articles in the press or in specialised publications
8. annual reports on economic results and company profiles
9. invoices and other commercial documents
10. advertising and promotional material
11. evidence of a presence and activity on the Internet

Sworn or affirmed statements

The weight and probative value of statutory declarations is determined by the general rules the Office applies when assessing such evidence. In particular, both the capacity of the person giving the evidence and its relevance to the particular case must be taken into account. For further details on the weight and probative value of affidavits, see the Guidelines, [Part C, Opposition, Section 7, Proof of use](#).

Case No	Comment
12/05/2011, <a href="#">R 729/2009-1</a> , SKYBLOG / SKY et al.	The statement submitted by an expert consultancy firm in the area of digital media strategy in the UK attests to the fact that the opponent is 'the leading supplier of digital television in the UK' and that 'Sky has an enormous and impressive reputation' (para. 37).

Decisions of courts or administrative authorities

Opponents often invoke decisions of national authorities or courts that have accepted the reputation of the earlier mark. Even though national decisions are admissible evidence and may have evidentiary value, especially if they originate from a Member State the territory of which is also relevant for the opposition concerned, they are not binding for the Office, in the sense that it is not mandatory for the Office to follow their conclusion.

Case No	Comment
17/12/2010, <a href="#">T-192/09</a> , Seve Trophy, EU:T:2010:553	As far as judgments of Spanish courts are concerned, the European Union trade mark system is an autonomous system, consisting of a set of rules and objectives that are specific and applied independently of any national system (para. 79).

Since such decisions may serve to indicate reputation and to record successful enforcement of the mark, their relevance should be addressed and examined. Consideration should be given to the type of proceedings involved, to whether the issue was in fact reputation within the sense of [Article 8\(5\) EUTMR](#), to the level of the court, and to the number of such decisions.

Case No	Comment
---------	---------



10/05/2012, <a href="#">C-100/11 P</a> , Botolist / Botocyl, EU:C:2012:285	Decisions of the UK national office relating to the reputation of BOTOX are facts that may, if relevant, be taken into account by the General Court, despite the EUTM owners not being parties in those decisions (para. 78).
--	---

There might be differences between the substantive and procedural conditions applicable in national proceedings and those applied in opposition proceedings before the Office. Firstly, there may be differences as to how the requirement of reputation is defined or interpreted. Secondly, the weight the Office gives to the evidence is not necessarily the same as the weight given to it in national proceedings. Furthermore, national instances may be able to take into account *ex officio* facts known to them directly, whereas, under [Article 95 EUTMR](#), the Office may not.

For these reasons, the probative value of national decisions will be considerably enhanced if the conditions of law and facts on the basis of which they were taken are made abundantly clear. This is because, in the absence of these elements, it will be more difficult both for the applicant to exercise its right of defence and for the Office to assess the decision's relevance with a reasonable degree of certainty. Similarly, if the decision is not yet final, or if it is outdated due to the time that has elapsed between the two cases, its probative value will be diminished accordingly.

Consequently, the probative value of national decisions should be assessed on the basis of their contents and may vary depending on the case.

#### Office Decisions

The opponent may also refer to earlier Office decisions, on condition that such a reference is clear and unambiguous, and that the language of the proceedings is the same. Otherwise, the opponent must also file a translation of the decision within the 4-month period for filing further facts, evidence and arguments, in order to allow the applicant to exercise its right of defence.

As regards the relevance and probative value of previous Office decisions, the same rules as for national decisions apply. Even where the reference is admissible and the decision is relevant, the Office is not bound to come to the same conclusion and must examine each case on its own merits. Recognition of the reputation of an earlier mark cannot depend on prior recognition in the context of separate proceedings concerning the parties and different legal and factual elements. It is therefore for any party relying on the reputation of its earlier mark to establish, in the circumscribed context of each set of proceedings to which it is a party and on the basis of the facts that it considers most appropriate, that that mark has acquired a reputation; it cannot merely claim to adduce that evidence by virtue of its having been recognised, even for the same mark, in a separate administrative procedure (23/10/2015, [T-597/13](#), *dadida (fig.) / CALIDA*, EU:T:2015:804, § 43-45).

It follows that previous Office decisions only have a relative probative value and should be evaluated in conjunction with the rest of the evidence, especially where the

opponent relies on a previous Office decision without referring to particular materials filed in the corresponding proceedings, that is, where the applicant has not had a chance to comment on such materials, or where the time that has elapsed between the two cases is quite long. The situation may be different if the evidence to which the opponent refers had been submitted in other proceedings between the same parties and the applicant had been aware of the evidence concerning the reputation of an earlier mark (22/01/2015, [T-322/13](#), KENZO, EU:T:2015:47, § 18).

Opinion polls and market surveys

Opinion polls and market surveys are the most suitable means of evidence for providing information about the degree of knowledge of the mark, the market share it has, or the position it occupies in the market in relation to competitors' goods.

The probative value of opinion polls and market surveys is determined by the status and degree of independence of the entity conducting it, by the relevance and accuracy of the information it provides, and by the reliability of the method applied.

More particularly, in evaluating the credibility of an opinion poll or market survey, the Office needs to know the following.

1. Whether or not it has been conducted by an independent and recognised research institute or company, in order to determine the reliability of the source of the evidence (27/03/2014, [R 540/2013-2](#), Shape of a bottle (3D), § 49).
2. The number and profile (sex, age, occupation and background) of the interviewees, in order to evaluate whether the results of the survey are representative of the different kinds of potential consumers of the goods in question.
3. The method and circumstances under which the survey was carried out and the complete list of questions included in the questionnaire. It is also important to know how and in what order the questions were formulated, in order to ascertain whether the respondents were confronted with leading questions.
4. Whether the percentage reflected in the survey corresponds to the total amount of persons questioned or only to those who actually replied.

Unless the above indications are present, the results of a market survey or opinion poll should not be considered of high probative value, and will not in principle be sufficient on their own to support a finding of reputation.

Case No	Comment
---------	---------

<p>08/04/2011, <a href="#">R 925/2010-2</a>, 1 CLEAN! 2 FRESH! 3 STRONG! (fig.) / FRESH &amp; CLEAN et al.</p>	<p>The cancellation applicant did not submit sufficient proof of the reputation of its trade marks. According to the extracts from the 2001 survey conducted in Italy, although the level of 'prompted recognition' stands at 86 %, the rate of 'spontaneous recognition' is only 56 %. Moreover, no indication is given of the questions put to the people surveyed, making it impossible to determine whether the questions were really open and unassisted. The survey further fails to state for which goods the trade mark is known (para. 27).</p>
<p>27/03/2014, <a href="#">R 540/2013-2</a>, Shape of a bottle (3D)</p>	<p>The surveys do not seem to be carried out by the well-known GfK company, as the applicant argues, but rather by a Mr Philip Malivore who, according to his own declaration, is only 'a former director of GfK'. The Board is thus perplexed as to how a former employee of GfK can be authorised to use that company's logo on each and every page of the surveys when he is now 'an independent market research consultant'. These facts cast considerable doubt on the source, reliability and independent nature of the surveys (para. 49).</p>

Likewise, if the above indications are given, but the reliability of source and method are questionable, the statistical sample is too small, or the questions were leading, the credibility of the evidence will be diminished accordingly.

Case No	Comment
15/03/2011, <a href="#">R 1191/2010-4</a> , MÁS KOLOMBIANA ...Y QUÉ MÁS!! / COLOMBIANA LA NUESTRA	The survey submitted by the opponent does not provide conclusive information to demonstrate that the earlier sign is well known to the Spanish public for <i>aerated waters</i> as the interviewees were carefully selected on the basis of their origin, that is, Colombians resident in Spain. This is only a very small part of the population living in Spain. The figures relating to sales, to investment in publicity and to the mark's presence in publications targeting the immigrant public, contained in the statement made before a notary public, are likewise insufficient for a finding that the earlier sign is well known. Moreover, the statements are not corroborated by conclusive data on the extent or turnover of the goods (para. 23).
01/06/2011, <a href="#">R 1345/2010-1</a> , Fukato Fukato (fig.) / DEVICE OF A SQUARE (fig.) et al.	In support of its claim under <a href="#">Article 8(5) EUTMR</a> , the opponent relies exclusively on an opinion poll that was carried out in 2007. That opinion poll was conducted by an independent company. In principle, samples of 1 000-2 000 interviewees are considered sufficient, provided they are representative of the type of consumer concerned. The opponent's opinion poll was based on a sample of 500 interviewees, which is not sufficient in respect of the services for which reputation is claimed. According to the opinion poll, the logo of the earlier mark has been associated especially with services in the financial and insurance fields. Since the opposition is only based on Class 42 with regard to the earlier European Union trade mark, it does not cover financial and insurance services. Consequently, the opinion poll submitted is not suitable proof of the reputation of the opponent's European Union trade mark (para. 58).

Conversely, opinion polls and market surveys that fulfil the above requirements (independence and trustworthiness of source, reasonably large and widespread sample and reliable method) will be a strong indication of reputation, especially if they show a high degree of trade mark awareness.

#### Audits and inspections

Audits and inspections of the opponent's undertaking may provide useful information about the intensity of use of the mark, as they usually comprise data on financial results, sales volumes, turnover, profits, etc. However, such evidence will be pertinent only if it specifically refers to the goods sold under the mark in question, rather than to the opponent's activities in general.

Audits and inspections may be carried out on the initiative of the opponent itself, or may be required by company law and/or financial regulations. In the former case, the same rules as for opinion polls and market surveys apply, that is, the status of the entity conducting the audit and the reliability of the applied method will be of essence for determining its credibility, with the probative value of official audits and inspections being as a rule much higher, since they are usually conducted by a state authority or by a recognised body of auditors on the basis of generally accepted standards and rules.

#### Certification and awards

This kind of evidence includes certification and awards by public authorities or official institutions, such as chambers of commerce and industry, professional associations and societies, consumer organisations, etc.

The reliability of certification by authorities is generally high, as emanating from independent and specialised sources, which attest facts in the course of their official tasks. For example, the average circulation figures for periodicals issued by the competent press-distribution associations are conclusive evidence about the performance of a mark in the sector.

Case No	Comment
25/01/2011, <a href="#">R 907/2009-2</a> , O2PLS / O2 et al.	The many brand awards won by the mark were, together with the huge investment in advertising and the number of articles published in different publications, considered an important part of the evidence for reputation (para. 9(iii) and para. 27).

The same applies to quality certification and awards granted by such authorities, as the opponent usually has to meet objective standards in order to receive the award. Conversely, prizes and awards offered by unknown entities, or on the basis of unspecified or subjective criteria, should be given very little weight.

The relevance of a certification or award to the specific case largely depends on its contents. For example, the fact that the opponent is a holder of an ISO 9001 quality certificate, or of a royal warrant, does not automatically mean that the sign is known to the public. It only means that the opponent's goods meet certain quality or technical standards or that it is a supplier of a royal house. However, if such evidence is coupled with other indications of quality and market success, it may lead to the conclusion that the earlier mark has a reputation.

#### Articles in the press or in specialised publications

The probative value of press articles and other publications concerning the opponent's mark mainly depends on whether such publications are covert promotional matter, or if, on the contrary, they are the result of independent and objective research.

Case No	Comment
16/12/2010, <a href="#">T-345/08</a> & <a href="#">T-357/08</a> , Botolist / Botocyl, confirmed 10/05/2012, <a href="#">C-100/11 P</a>	The very existence of articles in a scientific publication or the general-interest press constitutes a relevant factor in establishing the reputation of the products marketed under the trade mark BOTOX amongst the general public, irrespective of the positive or negative content of those articles (para. 54).
10/03/2011, <a href="#">R 555/2009-2</a> , BACI MILANO (fig.) / BACI & ABBRACCI	The reputation of the earlier trade mark in Italy was proven by the copious amount of documentation submitted by the opponent, which included, inter alia, an article from <i>Economy</i> revealing that in 2005 the 'BACI & ABBRACCI' trade mark was one of the fifteen most counterfeited fashion brands in the world; an article published in <i>Il Tempo</i> on 05/08/2005, in which the 'BACI & ABBRACCI' trade mark is mentioned alongside others, including Dolce & Gabbana, Armani, Lacoste and Puma, as being targeted by counterfeiters; an article published in <i>Fashion</i> on 15/06/2006, in which the trade mark is defined as 'a true market phenomenon'; publicity campaigns from 2004 to 2007, with testimonials from entertainment and sports celebrities; and a market survey conducted by the renowned independent agency Doxa in September 2007, from which it emerges that the trade mark is 'top of mind' in the fashion sector for 0.6 % of the Italian public (para. 35).

Hence, if such articles appear in publications of a high status or are written by independent professionals, they will have quite a high value, as for example when the success of a specific brand becomes the object of a case study in specialised journals or in scientific publications. The presence of a mark in a dictionary (which is not a press article but is still a publication) is a means of evidence with high value.

Case No	Comment
---------	---------

16/12/2010, <a href="#">T-345/08</a> & <a href="#">T-357/08</a> , Botolist / Botocyl, confirmed by 10/05/2012, <a href="#">C-100/11 P</a>	The inclusion of a word in a dictionary is the expression of a fair amount of recognition on the part of the public. The references in the 2002 and 2003 editions of a number of dictionaries published in the United Kingdom constitute one of the items of evidence that may establish the reputation of the trade mark BOTOX in that country or amongst the English-speaking public of the European Union (paras 55 and 56).
---	---

#### Annual reports on economic results and company profiles

This type of evidence includes all kinds of internal publications giving varied information about the history, activities and perspectives of the opponent's company, or more detailed figures about turnovers, sales, advertising, etc.

To the extent that such evidence derives from the opponent and is mainly intended to promote its image, its probative value will mostly depend on its contents, and the relevant information should be treated with caution, especially if it mainly consists of estimates and subjective evaluations.

However, where such publications are circulated to clients and other interested circles and contain objectively verifiable information and data, which may have been compiled or revised by independent auditors (as is often the case with annual reports), their probative value will be substantially enhanced.

#### Invoices and other commercial documents

All kinds of commercial documents may be grouped under this heading, such as invoices, order forms, distribution and sponsoring contracts, samples of correspondence with clients, suppliers or associates, etc. Documents of this sort may provide a great variety of information on intensity of use, geographical extent and duration of use of the mark.

Even though the relevance and credibility of commercial documents is not disputed, it will generally be difficult to prove reputation on the basis of such materials alone, given the variety of factors involved and the volume of documents required. Furthermore, evidence relating to distribution or sponsoring contracts and commercial correspondence are more appropriate for giving indications about the geographical extent or promotional side of the opponent's activities, than for measuring the success of the mark in the market, and thus may only serve as indirect indications of reputation.

Case No	Comment
---------	---------

<p>14/04/2011, <a href="#">R 1272/2010-1</a>, GRUPO BIMBO (fig.) / BIMBO et al.                   (08/07/2015, <a href="#">T-357/11</a>, GRUPO BIMBO (fig.) / BIMBO et al., EU:T:2015:534)</p>	<p>The evidence submitted shows a high level of recognition of the mark on the Spanish market. The total invoices on the Spanish tin-loaf market in 2004 amounted to EUR 346.7 million, of which the opponent's invoices amounted to EUR 204.9 million. The invoices submitted cover advertisements on TV, as well as in newspapers and magazines. Therefore, the reputation of 'BIMBO' in Spain for <i>industrially produced bread</i> has been substantiated (para. 64).</p> <p>The Court did not address this point.</p>
--	---

Advertising and promotional material

This kind of evidence may take various forms, such as press cuttings, advertising spots, promotional articles, offers, brochures, catalogues, leaflets, etc. In general, such evidence cannot be conclusive of reputation on its own, due to the fact that it cannot give much information about actual trade mark awareness.

However, some conclusions about the degree of exposure of the public to advertising messages concerning the mark may be drawn by reference to the kind of medium used (national, regional, local) and the audience rates or circulation figures attained by the relevant spots or publications — if, of course, this kind of information is available.

Case No	Comment
---------	---------



<p>10/01/2011, <a href="#">R 43/2010-4</a>, FFR (fig.) / CONSORZIO VINO CHIANTI CLASSICO (fig.), (05/12/2012, <a href="#">T-143/11</a>, F.F.R., EU:T:2012:645)</p>	<p>The documents submitted show that the device of a black rooster has acquired reputation and will be associated with wines from the Chianti Classico region. The opponent provided several copies of <b>advertisements in newspapers and magazines, showing its promotional activity</b>, as well as independent articles displaying a black rooster in connection with the Chianti Classico region.</p> <p>However, given that the reputation only pertains to the device of a black rooster and given that this device is only one part of the earlier marks, serious doubts arise about whether reputation can be attributed to the marks as a whole. Moreover, for the same reason, doubt also arises about which marks the reputation could be attributed to, given that the opponent owns several marks. (paras 26 and 27).</p> <p>The Court did not assess the evidence on reputation.</p>
--	---

In addition, such evidence may give useful indications of the kind of goods covered, the form in which the mark is actually used and the kind of image the opponent is trying to create for its brand. For example, if the evidence shows that the earlier registration for which reputation is claimed covers a device, but in fact this device is used in combination with a verbal element, it would not be correct to accept that the device itself has a reputation. Rather, it should be assessed whether the reputation extends to the device. For that purpose, it is important to assess whether the device plays a predominant or even significant role when used in combination with the verbal element, and has acquired a reputation in itself. This has to be assessed on a case-by-case basis. See example judgments in [paragraph 3.1.2.6](#).

#### Evidence of a presence and activity on the Internet

Endeavouring to converge trade mark practices, the European Union Intellectual Property Network published a Common Communication on the Common Practice of Evidence in Trade Mark Appeal Proceedings: Filing, Structure and Presentation of Evidence, and the Treatment of Confidential Evidence on 31 March 2021 ([CP12](#))<sup>(70)</sup>. Although CP12 relates principally to evidence submitted in appeal proceedings, certain parts, for example that referring to evidence originating from the Internet, provide useful and relevant guidance in general.

As a consequence of the growing importance of information technologies and the Internet to personal, social and economic life, parties are increasingly relying on evidence originating from the Internet to show the use and reputation of their marks.

<sup>70</sup> Available at <https://www.tmdn.org/network/converging-practices>.

Before all, it must be clarified that a **mere reference to a website (even if by a direct hyperlink)** where the Office can find further information is insufficient. Online evidence may only take the place of physical evidence where it concerns the filing or registration of the earlier rights, or the contents of the relevant national law to the extent it is accessible online from a source recognised by the Office ([Article 7\(3\)](#) and [Article 16\(1\)\(b\)](#) and [16\(1\)\(c\) EUTMDR](#)). This option is not contemplated in the law for other evidence. Furthermore, external hyperlinks cannot guarantee the continued secure availability and stability of the content they link to.

Evidence showing the presence of the earlier trade mark on the Internet may help establish that trade mark's reputation. If the earlier trade mark has a significant presence on the Internet (evidenced by the number of **subscribers to accounts** dedicated to this trade mark on social networks, or the **number of visitors** to blogs mentioning this trade mark), this may help assess the knowledge of the trade mark by the public concerned and may therefore support a finding of reputation (26/06/2019, [T-651/18](#), HAWKERS (fig.) / HAWKERS (fig.) et al., EU:T:2019:444, § 33).

The nature of materials originating from the Internet raises the question of reliability of that evidence as it may be difficult to establish the actual content available on the Internet and the date or period of time this content was in fact made available to the public. Screenshots of a website or extracts from social media do not necessarily show whether the mark was used during the relevant time period or in the relevant territory. Nor do they establish the intensity of the alleged commercial use, as they do not show who viewed the mark or when, or provide information about related transactions. Relevant indications that do more than merely show the mark's presence on the Internet and which serve to provide information about its extent of use and level of exposure could be, for instance, data on the number of visits to the site, emails received via the site or the volume of business generated. Other forms of communication or interaction with the website can also be helpful and the data can be corroborated by further evidence such as analytics reports, website traffic, reports showing the geographical location of users, etc.

Extracts from the online encyclopaedia Wikipedia or similar sources cannot be considered to be probative on their own, as the content may be amended at any time and, in certain cases, by any visitor, even anonymously (16/10/2018, [T-548/17](#), ANOKHI (fig.) / Kipling (fig.) et al., EU: T:2018:686, § 131, and the case-law cited therein). The reliability of such evidence should be assessed in the context of the evidence as a whole, with information confirmed by more than one source generally being considered more reliable than facts derived from isolated references.

### 3.2 The similarity of the signs

Similarity or identity between the signs is a precondition for the application of both [Article 8\(1\)\(b\)](#) and [Article 8\(5\) EUTMR](#). Accordingly, a finding of dissimilarity precludes both the application of [Article 8\(1\)\(b\)](#) and [8\(5\) EUTMR](#) (24/03/2011, [C-552/09 P](#), TiMiKinderjoghurt, EU:C:2011:177, § 66).

It is not apparent either from the wording of those provisions or from the case-law that the similarity between the marks at issue must be assessed in a different way. Accordingly, similarity should be assessed according to the same criteria that apply in the context of [Article 8\(1\)\(b\) EUTMR](#), thus taking into account elements of visual, aural or conceptual similarity (24/03/2011, [C-552/09 P](#), TiMiKinderjoghurt, EU:C:2011:177, § 52, 54). See the Guidelines, [Part C, Opposition, Section 2, Double Identity and Likelihood of Confusion, Chapter 4, Comparison of Signs](#).

However, those provisions **differ in terms of the degree of similarity required**. Whereas the protection provided for under [Article 8\(1\)\(b\) EUTMR](#) is conditional upon a finding of a degree of similarity between the marks at issue such that there is a likelihood of confusion between them on the part of the relevant section of the public, the existence of such a likelihood is not necessary for the protection conferred by [Article 8\(5\) EUTMR](#). Accordingly, the types of injury referred to in [Article 8\(5\) EUTMR](#) may result from **a lesser degree of similarity** between the marks in question, provided that it is sufficient for the relevant section of the public to make a connection between those marks, that is, to establish a link between them. If there is some similarity, **even faint**, between the marks, a global assessment must be carried out to ascertain whether, notwithstanding the low degree of similarity, other relevant factors such as the reputation or recognition enjoyed by the earlier mark serve to establish a link between the marks (24/03/2011, [C-552/09 P](#), TiMiKinderjoghurt, EU:C:2011:177, § 53, 66; 20/11/2014, [C-581/13 P](#) & [C-582/13 P](#), Golden balls, EU:C:2014:2387, § 72).

While a lesser degree of similarity between the marks may suffice to establish a link and a risk of injury, this is not a factor that affects the comparison of the marks. The purpose of the comparison is to establish whether the marks are similar or not, and, if so, determine their degree of similarity. At this stage, there should be no discussion as to whether the degree found is sufficient for [Article 8\(5\) EUTMR](#) to apply. This has to be examined later, when assessing the link between the marks and the risk of injury.



The following case-law examples illustrate the degree of similarity required for the purposes of applying [Article 8\(5\) EUTMR](#).

Earlier mark	Contested mark	Case No
		11/12/2014, <a href="#">T-480/12</a> , MASTER, EU:T:2014:1062

G&S: Class 29, 30, 32

Territory: EU



*Assessment:* The earlier mark is reputed for *non-alcoholic drinks*. While there are clear visual differences between the marks, there are also elements of visual similarity. The marks each have a 'tail' flowing from their first letters in a signature flourish. Moreover, they use the same font type, the Spenserian script, which is not commonly used in contemporary business. Given the degree of similarity, however faint, between those marks, it is not altogether inconceivable that the relevant public could make a link between them and, even if there is no likelihood of confusion, be led to transfer the image and the values of the earlier mark to the goods bearing the contested mark (paras 46-48, 57, 74).

Earlier mark	Contested mark	Case No
		<p>01/02/2018, <a href="#">T-105/16</a>, Raquel Superior Quality Cigarettes FILTER CIGARETTES (fig.) / FILTER CIGARETTES PM Marlboro 20 CLASS A CIGARETTES (fig.) et al., EU:T:2018:51</p>

G&S: Class 34

Territory: EU

*Assessment:* Since [Article 8\(5\) EUTMR](#) merely requires the similarity that exists to be capable of leading the relevant public to make a connection between the signs at issue, that is to say, to establish a link between them, but does not require that similarity to be capable of leading that public to confuse those signs, the protection that provision lays down in favour of marks with a reputation may apply even if there is a lower degree of similarity between the signs at issue (para. 75).

Earlier mark	Contested mark	Case No
		<p>16/01/2018, <a href="#">T-398/16</a>, COFFEE ROCKS (fig.) / STARBUCKS COFFEE (fig.) et al., EU:T:2018:4</p>

G&S: Class 43

Territory: EU

*Assessment:* The earlier mark is claimed to be reputed for *coffee* and *cafeteria services*. The marks have the same general appearance, in as much as they are circular devices consisting of a figurative element placed in the centre and a surrounding broad band with word elements of identical structures and two smaller white figurative elements; they use the same colours (black and white) and font type; they share the word 'coffee', which, despite its descriptive character, is an important similarity factor, especially considering the claim of reputation. Phonetically, the signs are similar due to the presence of the word 'coffee' and because the ending 'rocks' is phonetically similar to the ending 'bucks', particularly on account of the relevant English-speaking public's pronunciation of the letters 'o' and 'u'. Conceptually, the relevant public will associate both marks with the concept of a 'coffee house' due to the general appearance of the marks and the presence of the word 'coffee' in both of them (paras 51-64).

### 3.3 The link between the signs

The types of injury under [Article 8\(5\) EUTMR](#), where they occur, are the consequence of a certain degree of similarity between the earlier and later marks, by virtue of which the relevant section of the public makes a connection between those two marks, that is to say, establishes a link between them even though it does not confuse them (27/11/2008, [C-252/07](#), Intel, EU:C:2008:655, § 30, and the case-law cited therein). Therefore, before the examination of any risk of injury, it must be assessed whether the relevant public will **establish a link between the marks**, namely, whether the contested mark would, in the context of the contested goods and services, bring the earlier reputed mark to mind. That link between the marks must be appreciated globally, by taking into account all the relevant factors, and in particular the following.

- The strength of the reputation of the earlier mark.
- The degree of similarity between the conflicting marks. The more similar they are, the more likely it is that the later mark will bring the earlier reputed mark to the mind of the relevant public (06/07/2012, [T-60/10](#), Royal Shakespeare, EU:T:2012:348, § 26 and, by analogy, 27/11/2008, [C-252/07](#), Intel, EU:C:2008:655, § 44).
- The nature of the goods or services for which the earlier mark is reputed and the later mark seeks registration.
- The degree of similarity or the dissimilarity between the goods and services, and any overlap between the relevant public concerned by those goods and services. The goods or services may be so remote that the later mark is unlikely to bring the earlier mark to the mind of the relevant public (27/11/2008, [C-252/07](#), Intel, EU:C:2008:655, § 49). It must nevertheless be remembered that one of the key features of [Article 8\(5\) EUTMR](#) is that it provides protection also against dissimilar goods and services.
- The degree of distinctive character of the earlier reputed mark, whether inherent or acquired through use. The more inherently distinctive the prior mark, the more likely

it will be brought to a consumer’s mind when encountering a similar (or identical) later mark. Conversely, the less inherently distinctive the earlier mark is, the more difficult it may prove to establish a link.

- The existence of likelihood of confusion on the part of the public.

This list is not exhaustive, and a link between the marks at issue may be established or excluded on the basis of only some of those criteria.

The question of whether the relevant public will establish a link between the marks must be answered in the light of the facts and circumstances of each case and the evidence and arguments provided by the parties, which then need to be weighed up. Even a faint similarity between the signs (which might not be sufficient for a finding of likelihood of confusion under [Article 8\(1\)\(b\) EUTMR](#) ) calls for the assessment whether a link between the signs will be established in the mind of the relevant public (11/12/2014, [T-480/12](#) , MASTER, EU:T:2014:1062, § 74). Moreover, a lack of coherent reasoning by the opponent is not sufficient reason for dismissing the claim where the relevant factors for the assessment indicate that a link will be made (factors such as the degree of reputation, the relationship between the signs, the proximity of the market sectors, an overlap of the relevant public).

The link will be more difficult to establish in cases where the market sectors concerned by the goods and services are remote, in the sense that a connection between the respective segments of the public is not obvious. In such situations, the opponent must justify why the marks will be associated, by reference to some other connection between its activities and those of the applicant, for example where the earlier mark is exploited outside its natural market sector, for instance, by licensing or merchandising.

Earlier mark	Contested mark	Case No
TWITTER		16/03/2012, <a href="#">R 1074/2011-5</a> , Twitter (fig.) / TWITTER
Reputed for services in Classes 38, 42 and 45, inter alia, <i>a website for social networking</i>	Classes 14, 18 and 25	
The contested goods such as t-shirts, key chains, watches, hand bags, jewellery, caps, etc., are very frequently used for marketing means or merchandising products bearing trade marks that relate to entirely distinct goods and services. Due to the strong reputation of the earlier mark, the relevant consumer would inevitably make a mental connection with it upon encountering that mark being used on a watch, a scarf or a t-shirt (para. 40).		

The fact that the goods and services designated by the marks at issue belong to distant sectors of trade is not, in itself, sufficient to exclude the possibility of the existence of a

link. The specific reputation of the earlier mark (including qualitative aspects, such as a particular image, lifestyle, or particular circumstances of marketing that have become associated with the reputation of the mark) and the degree of similarity between the marks could make it possible for the image of the reputed mark to be transferred to the contested mark notwithstanding the distance between the relevant market sectors.

However, where the goods and services designated by the marks address the general public on the one hand, and a specialised public on the other, the mere fact that members of the specialised public are necessarily part of the general public is not conclusive as to the existence of a link. The fact that a specialised public may be familiar with the earlier mark covering goods or services aimed at the general public, that is not sufficient to demonstrate that that specialised public will establish a link between the marks at issue (26/09/2018, [T-62/16](#) , PUMA (fig.) / PUMA (fig.) et al., EU:T:2018:604, § 45-46).

If the earlier mark is an EUTM, it is true that reputation shown in the territory of a single Member State may suffice to prove the reputation of an EUTM (06/10/2009, [C-301/07](#) , Pago, EU:C:2009:611, § 29-30). This does not amount, however, to conferring the EUTM with reputation **throughout** the EU (as opposed to **in** the EU) and, consequently, conferring the EUTM with its full scope of protection throughout the EU. The link has to be assessed from the perception of the actual public for which the earlier EUTM has been found to be reputed because only this public, which is familiar with the EUTM, can possibly make a connection between the marks (03/09/2015, [C-125/14](#) , Be impulsive / Impulse, EU:C:2015:539, § 29, 34). In any event, if a link cannot be established in a part of the EU where the earlier EUTM is known by a commercially pertinent part of the relevant public, it would be incorrect to find a link in another part of the EU where the earlier mark is not known merely, for example, on the basis that the marks would be perceived to be more similar (e.g. due to linguistic reasons, leading to lack of conceptual differences or to a higher degree of distinctive character of the overlapping element).

The existence of a family of marks is also a factor to be taken into account in assessing the establishment, on the part of the relevant public, of a link between the marks at issue (05/07/2016, [T-518/13](#) , MACCOFFEE, EU:T:2016:389, § 73).

#### Examples where a link was found between the signs

The following are examples where it was found that the degree of similarity between the signs (together with further factors) was sufficient to conclude that consumers would establish a link between them.



Earlier mark	Contested mark	Case No
BOTOX	BOTOLIST and BOTOCYL	16/12/2010, <a href="#">T-345/08</a> & <a href="#">T-357/08</a> , Botolist / Botocyl, EU:T:2010:529, confirmed by 10/05/2012, <a href="#">C-100/11 P</a> , Botolist / Botocyl, EU:C:2012:285
<p>There is a low degree of similarity between the opponent's <i>pharmaceutical preparations for the treatment of wrinkles</i> for which the earlier mark is reputed and the contested <i>cosmetics among other creams</i> . The remaining contested goods, namely <i>perfumes, sun-tanning milks, shampoos, bath salts</i> , etc., are dissimilar. Nevertheless, the goods at issue concern related market sectors. The relevant public – practitioners as well as the general public – would not fail to notice that both contested marks begin with 'BOTO-', which comprises almost the whole of the earlier mark BOTOX. 'BOTO-' is not a common prefix, either in the pharmaceutical field or in the cosmetic field and that it has no descriptive meaning. The relevant public would establish a link between the marks at issue (paras 65 to 79).</p>		

Earlier mark	Contested mark	Case No
RED BULL		11/01/2010, <a href="#">R 70/2009-1</a> , RED DOG (fig.) / RED BULL et al.
<p>The relevant public would establish a link between the marks because (i) the marks have some relevant common features, (ii) the conflicting goods in Classes 32-33 are identical, (iii) the earlier mark is reputed, (iv) the earlier mark has acquired a strong distinctive character through use and (v) there might be a possibility of confusion (paras 19 and 24).</p>		

Earlier mark	Contested mark	Case No
Viagra	Viaguara	25/01/2012, <a href="#">T-332/10</a> , Viaguara, EU:T:2012:26
<p>The earlier mark is reputed for <i>pharmaceuticals for the treatment of erectile dysfunctions</i> in Class 5, whereas the contested mark covers <i>non-alcoholic and alcoholic drinks</i> in Classes 32 and 33. Although the goods at issue are dissimilar, a link is likely to be established between the marks due to their high degree of similarity and the strong reputation of the earlier mark (para. 52).</p>		



Earlier mark	Contested mark	Case No
RSC-ROYAL SHAKESPEARE COMPANY	Royal Shakespeare	06/07/2012, <a href="#">T-60/10</a> , Royal Shakespeare, EU:T:2012:348



The earlier mark is reputed for *theatre productions* , whereas the contested mark covers *non-alcoholic and alcoholic drinks and providing of food and drink, restaurants, bars, pubs, hotels; temporary accommodation*. There is a certain proximity between the contested goods and the opponent's *theatre productions* . It is common practice in theatres to offer bar and catering services either alongside and during the interval of a performance. In view of the exceptional reputation of the earlier mark and the similarity between the marks, the relevant UK public would make a link with the earlier mark when confronted with the contested goods bearing the contested mark in a supermarket or in a bar (para. 60).

Examples where no link was found between the signs

The following are examples where an overall assessment of all of the relevant factors showed that it was unlikely that a link would be established between the signs.

Earlier mark	Contested mark	Case No
		11/11/2020, <a href="#">T-820/19</a> , Lottoland / LOTTO (fig.) et al., EU:T:2020:538, § 64, 66
<p>Notwithstanding the strong reputation of the earlier figurative mark and the above-average degree of similarity between the marks, the lack of any link between the services (relating to gambling in Class 41 of the earlier mark and scientific and technological services in Class 42 of the contested mark) and the difference between the relevant publics, one of which is a specialist public with a high level of attention, are such that the existence of a link between the marks can be ruled out (para. 66).</p>		

Earlier mark	Contested mark	Case No
G-STAR 	and 	21/01/2010, <a href="#">T-309/08</a> , G Stor, EU:T:2010:22

Earlier mark	Contested mark	Case No
<p>Visually, the signs have a different overall impression due to the figurative element of a Chinese dragon's head placed at the beginning of the mark applied for. Aurally, the marks are highly similar. Conceptually, the element 'star' of the earlier marks will be perceived as referring to a star or a famous person throughout the EU. It is possible that a part of the relevant public will attribute to the element 'stor' of the contested mark the sense of the Danish and Swedish word 'stor', meaning 'big, large', or will regard it as a reference to the English word 'store' meaning 'shop, storage'. It is, however, more likely that the majority of the relevant public will not attribute any particular meaning to that element. Therefore, the relevant public will perceive the marks at issue as conceptually different inasmuch as the earlier marks have a clear meaning throughout the EU, while the mark applied for has either a different meaning for part of the relevant public or no meaning. According to settled case-law, where the meaning of at least one of the two signs at issue is clear and specific so that it can be grasped immediately by the relevant public, the conceptual differences between those signs may counteract the visual and aural similarities between them. Therefore, the visual and conceptual differences between the marks prevent any possible link to be made between them (paras 25 to 36).</p>		

Earlier mark	Contested mark	Case No
ONLY		<p>07/10/2010, <a href="#">R 1556/2009-2</a> , only givenchy (fig.) / ONLY et al. (confirmed 08/12/2011, <a href="#">T-586/10</a> , Only Givenchy, EU:T:2011:722)</p>
<p>The goods at issue are identical (Class 3). Even if the earlier mark had a reputation, the differences between the marks, in particular due to the conceptual unit created by the combination of the element 'only' and the distinctive dominant element 'givenchy', would be significant enough for the public not to make any connection between them (paras 65 and 66).</p>		

Earlier mark	Contested mark	Case No
SYLVANIA		<p>30/09/2016, <a href="#">T-430/15</a> , Sylvania Food (fig.) / SYLVANIA et al., EU:T:2016:590</p>
<p>The lack of any similarity between the goods and services combined with the fact that the earlier mark does not have a strong reputation rule out any link between the marks at issue. It is unlikely that the quality image of the earlier mark associated with <i>lights and lamps</i> might be transferred to the <i>foodstuffs or food industry services</i> covered by the contested mark (para. 46).</p>		

### 3.4 The risk of injury <sup>71</sup>

#### 3.4.1 Protected subject matter

[Article 8\(5\) EUTMR](#) does not protect the reputation of the earlier mark as such, in the sense that it does not intend to prevent the registration of all marks identical with or similar to a mark with reputation. Once the condition as to the existence of reputation is fulfilled and a link has been established, it must be assessed whether the earlier mark would be detrimentally affected. A proven link between the marks is not sufficient, in itself, to establish that there may be one of the forms of injury referred to in [Article 8\(5\) EUTMR](#) (26/09/2012, [T-301/09](#), Citigate, EU:T:2012:473, § 96, and the case-law cited therein).

Apart from indicating origin, a trade mark may also fulfil other functions worthy of protection. In particular, a trade mark can offer a guarantee that all the goods coming from a single undertaking have the same quality (guarantee function) and it can serve as an advertising instrument by reflecting back the goodwill and prestige it has acquired in the market (advertising function) (17/10/1990, [C-10/89](#), Hag II, EU:C:1990:359; 11/07/1996, [C-427/93](#), [C-429/93](#) & [C-436/93](#), Bristol-Myers Squibb and Others / Paranova, EU:C:1996:282; 11/11/1997, [C-349/95](#), Ballantine, EU:C:1997:530; 04/11/1997, [C-337/95](#), Dior, EU:C:1997:517; 23/02/1999, [C-63/97](#), BMW, EU:C:1999:82).

It follows that trade marks serve not only to indicate the origin of a product, but also to convey a certain message or image to the consumer, which is incorporated in the sign mostly through use and, once acquired, forms part of its distinctiveness and repute. In most cases of reputation these features of the trade mark will be particularly developed, as the commercial success of a brand is usually based on product quality, successful promotion, or both, and, for this reason, will be especially valuable to the trade mark owner. This added value of a mark with reputation is precisely what [Article 8\(5\) EUTMR](#) intends to protect against undue detriment or unfair advantage.

Hence, the protection under [Article 8\(5\) EUTMR](#) extends to all cases where use of the contested mark is likely to have an adverse effect on the earlier mark, in the sense that it would diminish its attractiveness (detriment to distinctiveness) or devalue the image it has acquired among the public (detriment to repute), or where use of the contested mark is likely to result in misappropriation of the powers of attraction or exploitation of the image and prestige of the earlier mark (taking unfair advantage of its distinctive character or repute).

Given that a very strong reputation is both easier to harm and more tempting to take advantage of, owing to its great value, the Court underlined that ‘the stronger the earlier mark’s distinctive character and reputation the easier it will be to accept that detriment has been caused to it’ (27/11/2008, [C-252/07](#), Intel, EU:C:2008:655, § 67,

---

<sup>71</sup> For the purposes of these Guidelines, the term ‘injury’ covers taking ‘unfair advantage’ even though in such cases there is not necessarily an ‘injury’ in the sense of detriment either to the distinctive character or repute of the mark or, more generally, to its proprietor.

74; 25/05/2005, [T-67/04](#), Spa-Finders, EU:T:2005:179, § 41). The same must be accepted as regards the unfair advantage the applicant might enjoy at the expense of the earlier mark.

### 3.4.2 Assessment of the risk of injury

As stated in [paragraph 3.3](#), any type of injury under [Article 8\(5\) EUTMR](#) is the consequence of an association between the conflicting marks in the minds of the public, made possible by the similarities between the marks, their distinctiveness, the reputation and other factors.

The more immediately and stronger the earlier mark is brought to mind by the later sign, the greater the likelihood that current or future use of the sign is taking, or will take, unfair advantage of the distinctive character or the repute of the mark or is, or will be, detrimental to it (27/11/2008, [C-252/07](#), Intel, EU:C:2008:655, § 67-69; 18/06/2009, [C-487/07](#), L'Oréal, EU:C:2009:378, § 41, 43).

Therefore, the evaluation of detriment or unfair advantage must be based on an overall assessment of all the factors relevant to the case (including in particular the similarity of signs, the reputation of the earlier mark, and the respective consumer groups and market sectors), to determine whether the marks may be associated in a way that may adversely affect the earlier trade mark.

### 3.4.3 Types of injury

[Article 8\(5\) EUTMR](#) refers to the following types of injury: 'take unfair advantage of, or be detrimental to, the distinctive character or the repute of the earlier trade mark'. Therefore, [Article 8\(5\) EUTMR](#) applies if any of the following **three alternative requirements** is fulfilled, namely if use of the contested mark would:

- take unfair advantage of the distinctiveness, or the repute of the earlier mark;
- cause detriment to the distinctiveness;
- cause detriment to the repute.

As regards the first type of injury, the wording of [Article 8\(5\) EUTMR](#) suggests the existence of two kinds of unfair advantage, but settled case-law treats both as a single injury under [Article 8\(5\) EUTMR](#) (06/07/2012, [T-60/10](#), Royal Shakespeare, EU:T:2012:348, § 47). For the sake of completeness, both aspects of the same injury will be dealt with under [paragraph 3.4.3.1](#).

As demonstrated in the Guidelines [Part C, Opposition, Section 2, Double Identity and Likelihood of Confusion](#), likelihood of confusion relates only to confusion about the commercial origin of goods and services. [Article 8\(5\) EUTMR](#), in contrast, protects earlier reputed marks in cases of association or confusion that does not necessarily relate to the commercial origin of goods/services. [Article 8\(5\) EUTMR](#) protects the heightened effort and financial investment that is involved in creating and promoting trade marks to the extent that they become reputed by protecting these marks against later similar marks taking unfair advantage of, or being detrimental to, the distinctive

character or the repute of the earlier trade mark. There is a rich lexicon of vocabulary that is used in relation to this area of trade mark law. The most common terms are set out below.

Terms in Article 8(5) EUTMR	Commonly used equivalents
Unfair advantage	Free-riding, riding on the coat-tails
Detriment to distinctiveness	Dilution by blurring, dilution, blurring, watering down, debilitating, whittling away
Detriment to repute	Dilution by tarnishing, tarnishment, degradation

### 3.4.3.1 Taking unfair advantage of distinctiveness or repute

#### The nature of the injury

The notion of taking **unfair advantage of distinctiveness or repute** covers cases where the applicant benefits from the attractiveness of the earlier right by affixing on its goods/services a sign that is similar (or identical) to one widely known in the market and, thus, misappropriating its attractive powers and advertising value or exploiting its reputation, image and prestige. This may lead to unacceptable situations of commercial parasitism, where the applicant is allowed to take a ‘free ride’ on the opponent’s investment in promoting and building up goodwill for its mark, as it may stimulate sales of the applicant’s products to a disproportionately high extent in comparison with the size of its promotional investment.

Unfair advantage exists where there is a transfer of the image of the mark or of the characteristics that it projects to the goods identified by the identical or similar sign. By riding on the coat-tails of the reputed mark, the applicant benefits from the power of attraction, reputation and prestige of the reputed mark. The applicant also exploits, without paying any financial compensation, the marketing effort expended by the proprietor of the mark to create and maintain the image of that mark (18/06/2009, [C-487/07](#), L’Oréal, EU:C:2009:378, § 41, 49). It concerns the risk that the image of the mark with a reputation or the characteristics which it projects are transferred to the goods covered by the mark applied for, with the result that marketing of those goods is made easier by that association with the earlier mark with a reputation (19/06/2008, [T-93/06](#), Mineral Spa, EU:T:2008:215, § 40; 22/03/2007, [T-215/03](#), Vips, EU:T:2007:93, § 40; 30/01/2008, [T-128/06](#), Camelo, EU:T:2008:22, § 46).

#### The relevant consumer

The concept of ‘unfair advantage’ focuses on benefit to the later mark rather than harm to the earlier mark; what is prohibited is the exploitation of the earlier mark by the proprietor of the later mark. Accordingly, the existence of the injury consisting of unfair advantage obtained from the distinctive character or repute of the earlier mark must be assessed **by reference to average consumers of the goods or services for which the later mark is** applied for (27/11/2008, [C-252/07](#), Intel, EU:C:2008:655, § 35-36;

12/03/2009, [C-320/07 P](#), Nasdaq, EU:C:2009:146, § 46-48; 07/12/2010, [T-59/08](#), Nimei La Perla Modern Classic, EU:T:2010:500, § 35).

#### Assessing unfair advantage

To determine whether the use of a sign takes unfair advantage of the distinctive character or repute of the mark, it is necessary to undertake an **overall assessment**, which takes into account all the factors relevant to the circumstances of the case (10/05/2007, [T-47/06](#), Nasdaq, EU:T:2007:131, § 53, confirmed 12/03/2009, [C-320/07 P](#), Nasdaq, EU:C:2009:146; see also 23/10/2003, [C-408/01](#), Adidas, EU:C:2003:582, § 29, 30, 38; 27/11/2008, [C-252/07](#), Intel, EU:C:2008:655, § 57, 58, 66; 24/03/2011, [C-552/09 P](#), TiMiKinderjoghurt, EU:C:2011:177, § 53).

The misappropriation of the distinctiveness and repute of the earlier mark presupposes an **association** between the respective marks, which **makes possible the transfer of attractiveness and prestige** to the sign applied for. The more immediately and strongly the earlier reputed mark is brought to mind by the contested mark, the greater the likelihood that the current or future use of the mark would take unfair advantage of the distinctiveness or repute of the earlier mark. An association of this kind will be more likely in the following circumstances.

1. Where the earlier mark possesses a **strong reputation or a very strong (inherent) distinctive character**, because in such a case it will be both more tempting for the applicant to try to benefit from its value and easier to associate it with the sign applied for. Such marks will be recognised in almost any context, exactly because of their outstanding distinctiveness or 'good' or 'special' reputation, in the sense that it reflects an image of excellence, reliability or quality, or some other positive message, which could positively influence the choice of the consumer as regards goods of other producers (12/07/2011, [C-324/09](#), L'Oréal-eBay, EU:C:2011:474, § 44). The stronger the distinctive character of the earlier mark, the more likely it is that, when encountering a later identical or similar mark, the relevant public will associate it with that earlier mark (06/07/2012, [T-60/10](#), Royal Shakespeare, EU:T:2012:348, § 27).
2. The **more similar the marks** are, the more likely the risk of taking unfair advantage.
3. Where there is a **special connection** between the goods/services, which allows for some of the qualities of the opponent's goods/services to be attributed to those of the applicant. This will be particularly so in the case of **neighbouring markets**, where a 'brand extension' would seem more natural, as in the example of *pharmaceuticals* and *cosmetics*; the healing properties of the former may be presumed in the latter when it bears the same mark. Similarly, the Court has held that certain drinks (Classes 32 and 33) commercialised as improving sexual performance were linked to the properties of the goods in Class 5 (pharmaceutical and veterinary products and substances) for which the earlier mark, Viagra, was registered (25/01/2012, [T-332/10](#), Viaguara, EU:T:2012:26, § 74). Conversely, such a link was not found between *credit card services* and *cosmetics*, as it was thought that the image of the former is not transferable to the latter, even though their respective users largely coincide.



4. Where, in view of its special attractiveness and prestige, the earlier mark may be **exploited even outside its natural market sector**, for example, by licensing or merchandising. In this case, if the applicant uses a sign that is identical or similar to the earlier mark for goods for which the latter is already exploited, it will obviously profit from its de facto value in that sector (16/03/2012, [R 1074/2011-5](#), Twitter (fig.) / TWITTER).
5. Although **likelihood of confusion** between the two marks at issue is not required to demonstrate that the later mark takes unfair advantage of the earlier mark, where such likelihood is established on the basis of facts, this will be taken as proof that unfair advantage has been taken or that, at least, there is a serious risk of such injury in the future (07/12/2010, [T-59/08](#), Nimei La Perla Modern Classic, EU:T:2010:500, § 57, 58).
6. The existence of a **family of marks** may also be a relevant factor for assessing whether unfair advantage is being taken (05/07/2016, [T-518/13](#), MACCOFFEE, EU:T:2016:389, § 103).

Taking unfair advantage of the distinctiveness or repute of a trade mark may be a deliberate decision, for example where there is clear exploitation and riding on the coat-tails of a famous mark, or an attempt to trade upon the reputation of a famous mark. However, taking unfair advantage does not necessarily require a deliberate intention to exploit the goodwill attached to someone else's trade mark.

Therefore, bad faith is not in itself a condition for the application of [Article 8\(5\) EUTMR](#), which only requires that the advantage be 'unfair', in that there is **no justification** for the applicant's profit. However, where the evidence shows that the applicant is clearly acting in bad faith, there will be a strong indication of unfair advantage. The existence of bad faith may be inferred from various factors, such as an obvious attempt by the applicant to imitate an earlier sign of great distinctiveness as closely as possible, or where there is no apparent reason why it chose for its goods a mark that includes such a sign. Moreover, instances of actual use of the mark applied for (even outside the EU) may serve as basis for a logical inference relating to the likely commercial use of the mark applied for in the EU, in order to establish whether a risk of unfair advantage exists (07/12/2017, [T-61/16](#), MASTER (fig.) / COCA-COLA (fig.) et al., EU:T:2017:877, § 88).

Finally, the concept of unfair advantage in [Article 8\(5\) EUTMR](#) does not relate to the **detriment** caused to the reputed mark. Accordingly, advantage taken by a third party of the distinctive character or repute of the mark may be unfair even if the use of the identical or similar sign is not detrimental to the distinctive character or repute of the mark or, more generally, to its proprietor. It is, therefore, not necessary for the opponent to show that the applicant's benefit is detrimental to its economic interests or to the image of its mark (unlike with tarnishing, see below), as in most cases the 'borrowed' distinctiveness/prestige of the sign will principally affect the applicant's competitors, that is, traders dealing in identical/similar/neighbouring markets, by putting them at a competitive disadvantage. However, the possibility of simultaneous detriment to the opponent's interests should not be ruled out completely, especially in instances where

use of the sign applied for could affect the opponent's merchandising schemes, or would hinder its plans to penetrate a new market sector.

Cases on unfair advantage

*Risk of unfair advantage established*

Earlier mark	Contested mark	Case No
INTEL	INTELMARK	26/06/2008, <a href="#">C-252/07</a> , EU:C:2008:370
<p>In her opinion in the <i>Intel</i> preliminary ruling, Advocate General Sharpston referred to unfair advantage as follows: 'The concepts of taking unfair advantage of the distinctive character or repute of the mark in contrast must be intended to encompass "instances where there is clear exploitation and free-riding on the coattails of a famous mark or an attempt to trade upon its reputation". Thus by way of example Rolls Royce would be entitled to prevent a manufacturer of whisky from exploiting the reputation of the Rolls Royce mark in order to promote his brand. It is not obvious that there is any real difference between taking advantage of a mark's distinctive character and taking advantage of its repute; since however nothing turns on any such difference in the present case, I shall refer to both as free-riding' (para. 33).</p>		

Earlier mark	Contested mark	Case No
CITIBANK et al.		16/04/2008, <a href="#">T-181/05</a> , EU:T:2008:112



'... the reputation of the trade mark CITIBANK in the European Community in regard to banking services is not disputed. That reputation is associated with features of the banking sector, namely, solvency, probity and financial support to private and commercial clients in their professional and investment activities.'

'...there is a clear relationship ... between the services of customs agencies and the financial services offered by banks such as the applicants, in that clients who are involved in international trade and in the import and export of goods also use the financial and banking services, which such transactions require. It follows that there is a probability that such clients will be familiar with the applicants' bank given its extensive reputation at international level.'

'In those circumstances, the Court holds that there is a high probability that the use of the trade mark applied for, CITI, by customs agencies, and therefore for financial agency activities in the management of money and real estate for clients, may lead to free-riding, that is to say, it would take unfair advantage of the well-established reputation of the trade mark CITIBANK and the considerable investments undertaken by the applicants to achieve that reputation. That use of the trade mark applied for, CITI, could also lead to the perception that the intervener is associated with or belongs to the applicants and, therefore, could facilitate the marketing of services covered by the trade mark applied for. That risk is further increased because the applicants are the holders of several trade marks containing the component "citi" (paras 81 to 83).

Earlier mark	Contested mark	Case No
Spa	Mineral Spa	19/06/2008, <a href="#">T-93/06</a> , EU:T:2008:215
<p>MINERAL SPA (for soaps, perfumeries, essential oils, preparations for body and beauty care, preparations for the hair, dentifrices in Class 3) could take unfair advantage of the image of the earlier trade mark SPA and the message conveyed by it in that the goods covered by the contested application would be perceived by the relevant public as supplying health, beauty and purity. It is not a question of whether toothpaste and perfume contain mineral water, but whether the public may think that the goods concerned are produced from or with mineral water (paras 43 and 44).</p>		

Earlier mark	Case No
L'Oréal et al.	12/07/2011, <a href="#">C-324/09</a> , EU:C:2011:474

According to L'Oréal et al., the defendants manufactured and imported perfume that was a 'smellalike' of L'Oréal's fragrances but sold at a considerably lower price, using packaging that was reminiscent of the get-up covered by L'Oréal's marks. The defendants used comparison lists to present the perfumes, which they marketed as being imitations or replicas of goods bearing a trade mark with repute. Under Council Directive 84/450/EEC, comparative advertising that presents the advertiser's products as an imitation of a product bearing a trade mark is inconsistent with fair competition and thus unlawful. Therefore, any advantage gained by the advertiser through such advertising will have been achieved as a result of unfair competition and must be regarded as taking unfair advantage of the reputation of that mark).

Earlier mark	Contested mark	Case No
Nasdaq		10/05/2007, <a href="#">T-47/06</a> , EU:T:2007:131

'Taking account of the fact that the financial and stock market listing services supplied by the intervener under its trade mark Nasdaq and, therefore, the trade mark Nasdaq itself, undeniably present a certain image of modernity [the link between the signs] enables the transfer of that image to sports equipment and, in particular, to the high-tech composite materials which would be marketed by the applicant under the mark applied for, which the applicant appears to recognise implicitly by stating that the word 'nasdaq' is descriptive of its main activities.

Therefore, in light of that evidence, and taking account of the similarity of the marks at issue, the importance of the reputation and the highly distinctive character of the trade mark Nasdaq, it must be held that the intervener has established prima facie the existence of a future risk, which is not hypothetical, of unfair advantage being drawn by the applicant, by the use of the mark applied for, from the reputation of the trade mark Nasdaq. There is therefore no need to set aside the contested decision on that point' (paras 60 and 61).

Earlier mark	Contested mark	Case No
	Royal Shakespeare	06/07/2012, <a href="#">T-60/10</a> , EU:T:2012:348

There is a certain proximity and link between *entertainment services* and *beer*, even a certain similarity due to their complementarity. The public in the United Kingdom would be able to make a link with the Royal Shakespeare Company (RSC) when seeing a beer with the contested mark Royal Shakespeare in a supermarket or in a bar. The contested mark would benefit from the power of attraction, the reputation and the prestige of the earlier mark for its own goods and services, which would attract the consumers' attention thanks to the association with RSC, thereby gaining a commercial advantage over its competitors' goods. The economic advantage would consist of exploiting the effort expended by RSC to establish the reputation and the image of its earlier mark without paying any compensation in exchange. That equates to an unfair advantage (para. 61).

Earlier mark	Contested mark	Case No
Viagra	Viaguara	25/01/2012, <a href="#">T-332/10</a> , EU:T:2012:26

While recognising that the primary function of a trade mark was as an indicator of origin, the General Court held that a mark could also serve to transmit other messages, concerning particular qualities or characteristics of the designated goods or services, or the images and sensations projected by the mark itself, such as luxury, lifestyle, exclusivity, adventure or youth. In this sense, a trade mark possessed an intrinsic economic value that was autonomous and distinct to that of the goods or services for which it was registered (para. 57).

The risk of taking unfair advantage encompasses cases of manifest exploitation or parasitism of a mark with reputation, namely the risk of transferring the image of the mark with reputation or the characteristics projected by it to the goods covered by the mark applied for, thus facilitating the marketing of those goods through association with the earlier mark with reputation (para. 59).

The Court concluded that, even if the drinks claimed by the mark applied for would not in reality produce the same benefit as the 'immensely well-known' pharmaceutical for the treatment of erectile dysfunction, what was important was that the consumer, because of the transfer of positive associations projected by the image of the earlier mark, would be inclined to purchase such drinks in the expectation of finding similar qualities, such as an increase in libido (paras 52 and 67).

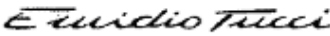
Earlier mark	Contested mark	Case No
EMILIO PUCCI 		27/09/2012, <a href="#">T-373/09</a> , Emidio Tucci, EU:T:2012:500  (18/06/2009, <a href="#">R 770/2008-2</a> & <a href="#">R 826/2008-2</a> , EMIDIO TUCCI (fig.) / EMILIO PUCCI (fig.))

Although the applicant's cosmetic products are dissimilar to the opponent's clothes, they both fall squarely within the realm of products that are often sold as luxury items under famous marks of well-known designers and manufacturers. Taking into account that the earlier mark is very well known and that the commercial contexts in which the goods are promoted are relatively close, BoA concluded that consumers of luxury clothes will make a connection between the applicant's mark for soaps, perfumery, essential oils, cosmetics and hair lotions in Class 3 and the famous mark 'EMILIO PUCCI', an association that will produce a commercial benefit as per the Board's findings (BoA para. 129).

BoA concluded that there was a strong likelihood that the applicant could exploit the reputation of the opponent's mark for its own benefit. The use of the mark applied for in connection with the goods and services mentioned above will almost certainly draw the relevant consumer's attention to the opponent's highly similar and very well-known mark. The applicant will become associated with the aura of luxury that surrounds the 'EMILIO PUCCI' brand. Many consumers are likely to think that there is a direct connection between the applicant's goods on the one hand, and the famous Italian fashion house on the other, perhaps in the form of a licensing agreement. The applicant could take unfair advantage of the fact that the public knows the trade mark 'EMILIO PUCCI' well in order to introduce its own highly similar trade mark without incurring any great risk or the costs of introducing a totally unknown trade mark onto the market (BoA para. 130).

The General Court confirmed the BoA findings.

Earlier mark	Contested mark	Case No
McDONALD'S et al		10/10/2019, <a href="#">T-428/18</a> , mc dreams hotels Träumen zum kleinen Preis! (fig.) / McDONALD'S et al., EU:T:2019:738

The prefix 'mc' of the opponent's family of marks has acquired a high degree of distinctiveness through its use on the fast-food market. Given the exceptional nature of the reputation of the earlier mark, the average level of attention of the relevant public, the existence of a degree of similarity between the marks and the significant degree of similarity between the services, as well as the existence of a family of marks, the structure of which is reproduced, at least in part, by the mark applied for, the relevant public would establish a link between the marks, even though the opponent did not offer any form of accommodation or hotel services. The relevant public would associate the mark applied for with the image of reliability, efficiency, low-cost services and, on that account, choose it instead of the services provided by its competitors. The mark applied for would therefore ride on the coat-tails of the earlier mark to benefit from the power of attraction, the reputation and the prestige of that mark. The economic advantage would consist, for the applicant, of exploiting the effort expended by the opponent to establish the reputation and the image of its earlier mark, without paying any compensation in exchange (paras 71, 85, 90 and 98).

*Risk of unfair advantage denied*

Earlier mark	Contested mark	Case No
	BEPOST	20/02/2018, <a href="#">T-118/16</a> , BEPOST / ePOST (fig.) et al., EU:T:2018:86
<p>Due to the significant differences between the marks and the weak distinctive character of the common element 'post', the relevant public will not make any link between the mark applied for and the earlier national word mark POST, since the term 'post', in the context of the mark applied for, is likely to be perceived merely as a reference to postal services (para. 115).</p>		

Earlier mark	Contested mark	Case No
Vips	Vips	22/03/2007, <a href="#">T-215/03</a> , EU:T:2007:93
<p>The earlier mark Vips has a reputation for restaurants, in particular fast-food chains. However, it was not proven that it also enjoys any particular prestige. The term Vips is laudatory in itself and extensively used in this manner. There is no explanation as to how the sales of software products under the mark Vips could possibly benefit from their association with a fast-food chain, even if a link were made. Therefore, the Court rules out the risk that use of the mark applied for would take unfair advantage of the distinctive character or repute of the earlier mark.</p>		

Earlier mark	Contested mark	Case No
Spa	Spa-Finders	25/05/2005, <a href="#">T-67/04</a> , EU:T:2005:179
<p>Spa has a reputation for <i>mineral water</i> in the Benelux. The contested mark, Spa-Finders, covers <i>publications, catalogues, magazines, newsletters, travel agency services</i>. The General Court declared that there was no detrimental link between the signs. The sign Spa is also used to denote the town of Spa and the racing circuit of the same name. There is no evidence of unfair advantage or any kind of exploitation of the fame of the earlier mark. The word Spa in the mark applied for only denotes the kind of publication concerned.</p>		

Earlier mark	Contested mark	Case No
TDK		19/12/2014, <a href="#">R 2090/2013-2</a> , TDK / TDK-EPC (fig.) et al.

The earlier mark 'TDK' has a reputation within the European Union for 'audio and videotape goods'. The opponent argued that '[b]uilding and construction is a specific commercial area in which use of a TDK could diminish a reputation of the sort and nature of a company such as the opponent'. The Board found that this argument, which seems to be a mixture of allegations that there is detriment to the reputation and detriment to the distinctive character of the earlier mark, is no more than a mere statement, which is not corroborated by any evidence that would demonstrate *prima facie* a serious risk of change in economic behaviour or of a reduction in the trade mark's power of attraction.

### 3.4.3.2 Detriment to distinctiveness

#### The nature of the injury

Detriment to the distinctive character of an earlier reputed mark (also referred to as 'dilution', 'whittling away' or 'blurring') is caused when that mark's ability to identify the goods/services for which it is registered and used as coming from its proprietor is weakened because use of a later similar mark leads to dispersion of the identity of the earlier reputed mark by making it less distinctive or unique (27/11/2008, [C-252/07](#), Intel, EU:C:2008:655, § 29).

[Article 8\(5\) EUTMR](#) states that a proprietor of a reputed mark may oppose EUTM applications that, without due cause, would be detrimental to the **distinctive character** of earlier reputed marks. Clearly, therefore, the object of protection is the **distinctiveness** of the earlier reputed mark. As demonstrated in the Guidelines, [Part C, Opposition, Section 2, Double Identity and Likelihood of Confusion, Chapter 5, Distinctiveness of the Earlier Mark](#), 'distinctiveness' refers to the greater or lesser capacity of a mark to identify the goods/services for which it has been registered as coming from a particular undertaking. Therefore, [Article 8\(5\) EUTMR](#) protects reputed marks against a reduction of their distinctive quality by a later similar mark even where the later mark relates to dissimilar goods/services.

Although the former wording of [Article 8\(5\) EUTMR](#) only referred to conflicts between dissimilar goods/services, in its judgments of 09/01/2003, [C-292/00](#), Davidoff, EU:C:2003:9; 23/10/2003, [C-408/01](#), Adidas, EU:C:2003:582, the Court held that this Article also covers similar or identical goods/services.

The protection provided in [Article 8\(5\) EUTMR](#), therefore, acknowledges that unrestrained use of a reputed mark by third parties, even on dissimilar goods, will eventually reduce the distinctive quality or uniqueness of that reputed mark. For example, if Rolls Royce were used on restaurants, pants, candy, plastic pens, yard brushes, etc., its distinctiveness would eventually be dispersed and its special hold upon the public would be reduced — even in relation to cars, for which it is reputed. Consequently, the Rolls Royce mark's ability to identify the goods/services for which it is registered and used as coming from its proprietor would be weakened in the sense that consumers of the goods for which the reputed mark is protected and reputed will be less inclined to associate it **immediately** with the owner that has built up the trade

mark's reputation. This is because, for those consumers, the mark now has several or many 'other' associations, where it previously had only one.

#### Relevant consumer

Detriment to the distinctive character of the earlier reputed mark must be assessed by reference to the average consumers of the goods and services **for which that mark is registered**, who are reasonably well informed and reasonably observant and circumspect (27/11/2008, [C-252/07](#), Intel, EU:C:2008:655, § 35).

#### The assessment of detriment to distinctiveness

Detriment to the distinctiveness of the earlier reputed mark occurs where use of a later similar mark reduces the distinctive quality of the earlier reputed mark. However, this cannot be found to occur merely because the earlier mark has a reputation and is identical with or similar to the mark applied for — such an approach would apply an automatic and indiscriminate finding of likelihood of dilution against all marks that are similar to reputed trade marks and would negate the requirement of proving detriment.

The Court held in *Intel* that Article 4(4)(a) of the First Council Directive 89/104/EEC (the equivalent of [Article 8\(5\) EUTMR](#)) must be interpreted as meaning that proof that use of the later mark would be detrimental to the distinctive character of the earlier mark requires evidence of a 'change in the economic behaviour' of the average consumer of the goods/services for which the earlier mark was registered, or a serious likelihood that such a change will occur in the future.

The Court has further elaborated on the concept of 'change in the economic behaviour of the average consumers' in its judgment of 14/11/2013, [C-383/12 P](#), *Répresentation d'une tête de loup*, EU:C:2013:741. It indicated that it is an autonomous objective condition, which cannot be deduced solely from subjective elements such as how consumers perceive the dispersion of the reputed mark's image and identity. The mere fact that consumers note the presence of a new similar sign that is likely to undermine the earlier mark's ability to identify the goods for which it is registered as coming from the mark's proprietor, is not sufficient by itself to establish the existence of detriment or a risk of detriment to the distinctive character of the reputed mark (paras 35 to 40).

The Court insists on a 'higher standard' for establishing dilution. The following two **autonomous** conditions must be substantiated by the opponent and reasoned by the Office.

- Dispersion of the reputed mark's image and identity in the relevant public's perception (**subjective condition**).
- A change in the economic behaviour of this public (**objective condition**).

Whilst the opponent does not need to submit evidence of **actual** detriment, it must convince the Office by adducing evidence of a serious future risk — which is not merely hypothetical — of detriment. The opponent may do this by submitting evidence that proves a likelihood of detriment on the basis of logical deductions made from an analysis of the probabilities (and not mere suppositions), and by taking account of normal practice in the relevant commercial sector as well as of all the other circumstances of the case (16/04/2008, [T-181/05](#), Citi, EU:T:2008:112, § 78, as cited in

22/05/2012, [T-570/10](#), *Répresentation d'une tête de loup*, EU:T:2012:250, § 52; confirmed 14/11/2013, [C-383/12 P](#), *Répresentation d'une tête de loup*, EU:C:2013:741, § 42-43).

#### First use

Detriment to distinctive character is characterised by an 'avalanche effect', meaning that the first use of a similar mark in a distinct market may not, in itself, dilute the identity or 'uniqueness' of the reputed mark but, over time, this would be the result, because this first use may trigger further acts of use by different operators, thus leading to its dilution or detriment to its distinctive character.

The Court has held that the first use of an identical or similar mark **may suffice, in some circumstances**, to cause actual and present detriment to the distinctive character of the earlier mark or to give rise to a serious likelihood that such detriment will occur in the future (27/11/2008, [C-252/07](#), *Intel*, EU:C:2008:655, § 75). In opposition proceedings before the Office, use of the contested sign may not have occurred at all. In this regard, the Office takes into account that future use of the contested sign, even if it were first use, may trigger further acts of use by different operators, under particular circumstances that are to be provided by the opponent, therefore leading to dilution by blurring. As seen above, the wording of [Article 8\(5\) EUTMR](#) provides for this by stating that use of the mark applied for without due cause '**would ... be detrimental to ... the distinctive character or the repute of the earlier trade mark**'.

Nevertheless, as set out above, the opponent bears the burden of showing that actual or future use causes, or is likely to cause, detriment to the distinctiveness of the earlier reputed mark.

#### Inherent distinctiveness of the earlier mark

The Court has stated that 'the more "unique" the earlier mark appears, the greater the likelihood that the use of a later identical or similar mark will be detrimental to its distinctive character' (27/11/2008, [C-252/07](#), *Intel*, EU:C:2008:655, § 74; 28/10/2010, [T-131/09](#), *Botumax*, EU:T:2010:458). Indeed, the earlier mark must possess an exclusive character in the sense that it should be associated by the consumers with a single source of origin — since it is only in this case that a likelihood of detriment to distinctiveness may be envisaged. If the same sign, or a variation thereof, is already in use in connection with a range of different goods, there can be no immediate link with any of the goods it distinguishes and, thus, there will be little or no room for further dilution.

Accordingly, '... the risk of dilution appears, in principle, to be lower if the earlier mark consists of a term which, because of a meaning inherent in it, is very common and frequently used, irrespective of the earlier mark consisting of the term at issue. In such a case, reuse of the term in question by the mark applied for is less likely to result in a dilution of the earlier mark' (22/03/2007, [T-215/03](#), *Vips*, EU:T:2007:93, § 38).

If, therefore, the mark is suggestive of a characteristic shared by a wide range of goods, the consumer is more likely to associate it with the specific feature of the product that it alludes to rather than with another mark.





In its judgment of 25/05/2005, [T-67/04](#), Spa-Finders, EU:T:2005:179, the General Court confirmed the finding that the use of the mark Spa-Finders for *publications* and *travel agency* services would neither blur the distinctiveness nor tarnish the reputation of the mark Spa for *mineral water*. The term ‘spa’ in Spa-Finders may be used otherwise than in a trade mark context since it ‘is frequently used to designate, for example, the Belgian town of Spa and the Belgian racing circuit of Spa-Francorchamps or, in general, places for hydrotherapy such as hammams or saunas, [and consequently] the risk of detriment to the distinctive character of the mark SPA seems to be limited’ (para. 44).

Thus, if the applicant shows that the earlier sign or the element that gives rise to similarity is commonplace and is already used by different undertakings in various sectors of the market, it may successfully refute the existence of a likelihood of dilution, because it will be difficult to accept that the attractiveness of the earlier mark risks being diluted if it is not particularly unique.

Cases on dilution by blurring

*Dilution established*

Earlier mark	Contested mark	Case No
		<a href="#">R 69/2013-4</a>
<p>Reputed for tobacco products</p>	<p>Foodstuffs in Classes 29, 30 and 32</p>	

First of all, taking into account the very high similarity between the conflicting marks and the high reputation of the earlier mark, there is a risk that the public will be led to believe that the CAMEL food products originate from, or that the mark is used with the consent of, the opponent. Moreover, the capacity of the reputed CAMEL mark to arouse immediate association with the opponent's business will be diminished by the use of the contested mark. The use of a highly similar mark for food products would be detrimental to the distinctive character of the reputed CAMEL trade mark for tobacco products, making this mark ordinary, which is in essence a diminution of the power of attraction of the mark. This will lead to dispersion of the identity and hold upon the public's mind of the earlier mark. The earlier mark, used to arouse immediate association with the goods for which it is registered, will no longer be capable of doing so. It follows that there is a clear probability of damage to the earlier mark's advertising function as a vehicle for building up and retaining brand loyalty, and that the economic value of the earlier reputed mark will be impaired, in the medium or long term, as a consequence of the use of the contested mark, in the sense that consumers of the goods for which the reputed mark is protected and known will be less inclined to associate it immediately with the undertaking that has built up the trade mark's reputation; this must be considered a change in their economic behaviour (para. 41).

### *Dilution denied*

<b>Earlier mark</b>	<b>Contested mark</b>	<b>Case No</b>
Vips	Vips	<a href="#">T-215/03</a>
Reputed for <i>fast food restaurant chain</i> in Class 42	<i>Computer programming for hotel services</i> in Class 42	



'So far as concerns, first, detriment to the distinctive character of the earlier mark by the use without due cause of the mark applied for, that detriment can occur where the earlier mark is no longer capable of arousing immediate association with the goods for which it is registered and used (*SPA-FINDERS*, paragraph 34 above, paragraph 43). That risk thus refers to the "dilution" or "gradual whittling away" of the earlier mark through the dispersion of its identity and its hold upon the public mind (Opinion of Advocate General Jacobs in *Adidas-Salomon and Adidas-Benelux*, paragraph 36 above, point 37)' (para. 37).

'As far as concerns, first, the risk that the use of the mark applied for would be detrimental to the distinctive character of the earlier mark, in other words the risk of "dilution" and "gradual whittling away" of that mark, as explained in paragraphs 37 and 38 above, it must be pointed out that the term "VIPS" is the plural form, in English, of the abbreviation VIP ("Very Important Person"), which is widely and frequently used both internationally and nationally to describe famous personalities. In those circumstances, the risk that the use of the mark applied for would be detrimental to the distinctive character of the earlier mark is limited' (para. 62).

'That same risk is also even less probable in the present case as the mark applied for covers the services "Computer programming relating to hotel services, restaurants, cafés", which are directed at a special and necessarily more limited public, namely the owners of those establishments. The consequence is that the mark applied for, if registration is allowed, will probably be known, through use, only by that relatively limited public, a factor that certainly reduces the risk of dilution or gradual whittling away of the earlier mark through the dispersion of its identity and its hold upon the public mind' (para. 63).

Earlier mark	Contested mark	Case No
Spa	Spa-Finders	<a href="#">T-67/04</a>
Reputed for <i>mineral waters</i> in Class 32	<i>Printed publications including catalogues, magazines, newsletters</i> in Class 16, <i>Travel agency</i> in Class 39	

'In the present case, the Court finds that the applicant does not put forward any evidence to support the conclusion that there is a risk of detriment to the distinctive character of the mark SPA by the use of the mark SPA-FINDERS. The applicant stresses the alleged immediate link that the public will establish between SPA and SPA-FINDERS. It infers from that link that there is detriment to the distinctive character. As the applicant acknowledged at the hearing, the existence of such a link is not sufficient to demonstrate the risk of detriment to the distinctive character. The Court notes, moreover, that since the term "spa" is frequently used to designate, for example, the Belgian town of Spa and the Belgian racing circuit of Spa-Francorchamps or, in general, places for hydrotherapy such as hammams or saunas, the risk of detriment to the distinctive character of the mark SPA seems to be limited' (para. 44).

Earlier mark	Contested mark	Case No
		<a href="#">C-383/12 P</a>
Reputed for <i>machine tools</i> in Class 7	<i>Machines for professional and industrial processing of wood and green waste; professional and industrial wood chippers and shredders</i> in Class 7	
<p>In the present case, the Court of Justice annuls the judgment of the General Court by stating that the detriment or the risk of detriment to the distinctive character of the earlier marks cannot be established without adducing the evidence of 'change in the economic behaviour of the average consumer' (para. 36). While the dispersion of the reputed mark's image and identity in the public's perception is a subjective condition, the change in the economic behaviour of this public is objective. It cannot be deduced from the mere fact that consumers note the presence of a new similar sign in a way that is likely to undermine the earlier mark's ability to identify the goods for which it is registered as coming from the proprietor of that mark (paras 37 and 39). The General Court should have examined whether any actual change in economic behaviour had occurred, or was likely to occur, on the basis of 'an analysis of the probabilities and by taking account of the normal practice in the relevant commercial sector as well as all the other circumstances of the case' (para. 43). Since it failed to do so, the General Court violated <a href="#">Article 8(5) EUTMR</a>.</p>		

### 3.4.3.3 Detriment to repute

#### The nature of the injury

The final type of damage under [Article 8\(5\) EUTMR](#) concerns harming the earlier mark by way of detriment to its repute. It can be seen as a step beyond blurring in that the mark is not merely weakened but actually degraded by the link that the public makes with the later mark. Detriment to repute, also often referred to as 'dilution by tarnishing' or simply as 'tarnishing', relates to situations where use of the contested mark without due cause is likely to devalue the image or the prestige that a mark with reputation has acquired among the public.

The reputation of the earlier trade mark may be tainted or debased in this way, either when it is reproduced in an obscene, degrading or inappropriate context, or in a context that is not inherently unpleasant but that proves to be incompatible with a particular image the earlier trade mark has acquired in the eyes of the public due to the

promotional efforts of its owner. The likelihood of such detriment may arise in particular from the fact that the goods or services offered by the third party possess a characteristic or a quality that is liable to have a negative impact on the image of the mark (18/06/2009, [C-487/07](#), L'Oréal, EU:C:2009:378, § 40). For example, if a reputed mark for gin were used by a third party on liquid detergent, this would reverberate negatively on the reputed mark in a way that makes it less attractive.

In short, tarnishment occurs where there is an association between the earlier reputed mark, at the level of either the signs or the goods, that is injurious to the earlier trade mark's repute.

#### Relevant consumer

As with dilution by blurring, detriment to the reputation of the earlier mark must be assessed by reference to average consumers of the goods and services for which that mark is registered, who are reasonably well informed and reasonably observant and circumspect (27/11/2008, [C-252/07](#), Intel, EU:C:2008:655, § 35; 07/12/2010, [T-59/08](#), Nimei La Perla Modern Classic, EU:T:2010:500, § 35).

#### The assessment of tarnishment

In order to establish detriment to the repute of an earlier mark, the mere existence of a connection in the mind of the consumer between the marks is neither sufficient nor determinative. Such a connection must certainly exist, but, **in addition**, either the signs or the goods/services covered by the later mark must provoke a negative or detrimental impact when associated with the reputed mark.

For example, if a mark that is associated in the minds of the public with an image of health, dynamism and youth is used for *tobacco products*, the negative connotation conveyed by the latter would contrast strikingly with the image of the former (see further examples below). For tarnishment to occur, therefore, the goods/services on which the contested mark is used must have characteristics or qualities that are potentially detrimental to the reputation of the earlier mark (22/03/2007, [T-215/03](#), Vips, EU:T:2007:93, § 67).

Frequently, opponents argue that the applicant's goods/services are of inferior quality or that the opponent cannot control the quality of such goods/services. The Office does not accept such an argument, *per se*, as a means of demonstrating detriment. Proceedings before the Office do not provide for assessing the quality of goods and services, which, apart from being highly subjective, would not be feasible in cases where the goods and services are not identical or in situations where the contested sign has not yet been put to use.



Therefore, when assessing whether use of the contested trade mark is likely to damage the reputation of an earlier trade mark, the Office can only consider the goods and services as indicated in the specification of each trade mark. Consequently, for the purposes of the Office's analysis, the harmful effects of use of the contested sign in connection with the goods and services applied for must derive from the nature and usual characteristics of the goods at issue in general, not their quality in particular instances. This approach does not leave the opponent without protection, because, where a later mark is used on low-quality goods/services in a manner that calls to mind

an earlier reputed mark, this would in any case normally take unfair advantage of the distinctive character or repute of the earlier trade mark or be detrimental to its distinctiveness.

### Cases on dilution by tarnishing



#### *Tarnishment established*

Earlier mark	Contested mark	Case No
KAPPA 	KAPPA	12/03/2012, <a href="#">R 297/2011-5</a> , KAPPA / KAPPA et al.
Reputed for <i>sports clothing and footwear</i>	<i>tobacco products, cigarettes, cigars, amongst others</i>	
<p>The contested application was filed for tobacco and related goods in Class 34. Smoking tobacco is universally considered to be an extremely unhealthy habit. For this reason, use of the sign KAPPA for tobacco and related goods is likely to prompt negative mental associations with the respondent's earlier marks or associations, conflicting with and being detrimental to their image of a healthy lifestyle (para. 38).</p>		

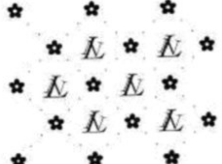

Earlier mark	Contested mark	Case No
		22/07/2010, <a href="#">R 417/2008-1</a> , SPACE NK (fig.) / SPA, LES THERMES DE SPA et al.
Reputed for <i>mineral waters</i>	<i>Scouring and polishing preparations and substances; pot pourri; incense; incense sticks; room fragrances and articles for perfuming rooms</i>	
<p>The pleasant notions conveyed generally by mineral water do not mix seamlessly with detergents and scouring preparations. Use of marks that contain the word SPA for goods conveying such different connotations is likely to damage, or tarnish, the distinctive character of the earlier mark (para. 101).</p> <p>'Mineral water is not pleasantly associated by most consumers with incense or pots pourris. The use, in order to distinguish fragrances and incense, of a mark containing a word (SPA) that Belgian consumers strongly associate to bottled drinking water is therefore likely to damage the attractive and suggestive power that the brand, according to the evidence, currently enjoys' (para. 103).</p>		

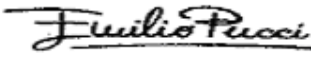
Earlier mark	Contested mark	Case No
		06/10/2011, <a href="#">R 2124/2010-1</a> ,
Reputed for goods in Classes 18 and 25	<i>Scientific, nautical, surveying, weighing, measuring, signalling, checking (supervision), life-saving and teaching apparatus and instruments; amongst others.</i>	LN (fig.) / LV (fig.) et al.
<p>The opponent demonstrated that the prestigious image of its trade marks is linked to the traditional manufacturing method of its fine leather goods, which are handmade by master craftsmen who work only with top-quality raw materials. It is this image of luxury, glamour and exclusivity, combined with the exceptional quality of the product, that the opponent has always striven to convey to the public, as the evidence adduced testifies. This image would be quite incompatible with goods of a strongly industrial and technological nature, such as electric meters, scientific microscopes, batteries, supermarket cash registers, fire-extinguishing apparatus or other instruments, for which the applicant intends to use its trade mark (para. 28).</p> <p>What would be detrimental to the image of its trade marks, which the opponent has carefully fostered for decades, is the use of a trade mark that recalls its own and is applied to goods characterised, in the public's perception, by a significant technological content (whereas a fine-leather article is rarely associated with technology) or as having an industrial origin (whereas fine leather goods are traditionally associated with craftsmanship) (para. 29).</p> <p>The use of a trade mark that is practically identical to a trade mark that the public has come to perceive as synonymous with fine leather goods of excellent manufacture for technical apparatus or electrical tools of all kinds will diminish its attraction, that is, its reputation, amongst the public that knows and values the earlier trade marks (para. 30).</p>		

Earlier mark	Contested mark	Case No
--------------	----------------	---------

EMILIO PUCCI 		
Reputed for <i>clothing and footwear for women</i>	Class 3: <i>Bleaching preparations and other substances for laundry use; cleaning, polishing, scouring and abrasive preparations; (abrasive preparations) soaps; perfumery, essential oils, cosmetics, hair lotions; dentifrices.</i>  Class 21: <i>Materials for cleaning purposes and steelwool</i>	27/09/2012, <a href="#">T-373/09</a> , Emidio Tucci, EU:T:2012:500  <a href="#">(R 770/2008-2 &amp; R 826/2008-2)</a>
<p>In its decisions of 18/06/2009 in <a href="#">R 770/2008-2</a> &amp; <a href="#">R 826/2008-2</a>, the Board stated that the risk of detriment to repute can occur where the goods and services covered by the mark applied for have a characteristic or a quality that may have a negative influence on the image of an earlier mark with a reputation on account of the mark applied for being identical or similar to the earlier mark with reputation. The General Court confirmed the Board's finding, adding that due to the great similarity between the signs at issue, the strong distinctive character of the Italian mark and its repute in the Italian market, it can be concluded that there is a link between the signs in conflict, a link that could damage the idea of exclusivity, luxury and high quality and therefore be detrimental to the repute of the Italian mark (para. 68).</p>		

*Tarnishment denied*

Earlier mark	Contested mark	Case No
 SEVE TROPHY	 SEVE TROPHY Sistema de Entretenimiento Virtual Español	17/12/2010, <a href="#">T-192/09</a> , Seve Trophy, EU:T:2010:553
Reputed for <i>organisation of sports competitions</i>	Class 9	
<p>The Court noted that the opponent had not demonstrated any risk of injury to the reputation of the earlier marks, since it had not indicated how the attractiveness of the earlier marks would be diminished by use of the contested mark on the contested goods. Specifically, it did not allege that the contested goods have any characteristic or quality that could have a negative influence on the image of the earlier marks (para. 68).</p>		



Earlier mark	Contested mark	Case No
Spa	Spa-Finders	25/05/2005, <a href="#">T-67/04</a> , Spa-Finders, EU:T:2005:179
Reputed for <i>mineral waters</i> in Class 32	<i>Printed publications including catalogues, magazines, newsletters</i> in Class 16, <i>Travel agency</i> in Class 39	
<p>'In the present case, SPA and SPA-FINDERS designate very different goods consisting, on the one hand, in mineral waters and, on the other, in publications and travel agency services. The Court finds that it is therefore unlikely that the goods and services covered by the mark SPA-FINDERS, even if they turn out to be of lower quality, would diminish the power of attraction of the mark SPA' (para. 49).</p>		

Earlier mark	Contested mark	Case No
Vips	Vips	<a href="#">T-215/03</a>
Reputed for <i>fast food restaurant chain</i> in Class 42	<i>Computer programming for hotel services</i> in Class 42	
<p>The Court pointed out that, 'although some fast food chain marks have an indisputable reputation, they do not, in principle and failing evidence to the contrary, convey a particularly prestigious or high-quality image, the fast food sector being associated with other qualities, such as speed or availability and, to a certain extent, youth, since many young people frequent that type of establishment' (para. 57)</p> <p>The Court further stated that 'the services covered by the mark applied for do not have any characteristic or quality capable of establishing the likelihood of detriment of that type to the earlier mark. The applicant neither cited, nor a fortiori proved, any characteristic or quality of that kind. The mere existence of a connection between the services covered by the conflicting marks is neither sufficient nor determinative. It is true that the existence of such a connection strengthens the probability that the public, faced with the mark applied for, would also think of the earlier mark. However, that factor is not, in itself, sufficient to diminish the earlier mark's power of attraction. Such an outcome can arise only if it is established that the services covered by the mark applied for have characteristics or qualities that are potentially detrimental to the reputation of the earlier mark. Such evidence has not been adduced in the present case' (para. 67).</p>		

Earlier mark	Contested mark	Case No

WATERFORD		23/11/2010, <a href="#">R 240/2004-2</a> , WATERFORD STELLENBOSCH
Reputed for <i>crystal products, including glassware</i> in Class 21	<i>Alcoholic beverages, namely wines produced in the Stellenbosch district, South Africa</i> in Class 33	(fig.) / WATERFORD
<p>'In the present case, on the one hand, it is not possible to attribute from the outset either any specific image to the reputed trade mark or any <i>prima facie</i> evidence of its tarnishment. On the other hand, the opponent has confined itself to pleading that "use and registration of the [contested] trade mark will take unfair advantage of the opponent's trade mark", without giving any evidence or <i>prima facie</i> evidence, even only by way of logical deductions, of such tarnishment. On the contrary, the Board finds no antagonism between either the nature or the way of using glassware and wine, such as that the use of the contested mark might tarnish the earlier mark's image.' (para. 91).</p>		

### 3.4.4 Proving the risk of injury

As stated in [paragraph 3.4.1](#), any risk of injury to the earlier reputed mark must be proven separately. In opposition proceedings detriment or unfair advantage may be only potential, as confirmed by the conditional wording of [Article 8\(5\) EUTMR](#), which requires that the use without due cause of the mark applied for '**would take** unfair advantage of, **or be** detrimental to the distinctiveness or repute of the earlier mark'.

However, the fact that detriment or unfair advantage may be only potential does not mean that a mere possibility is sufficient for the purposes of [Article 8\(5\) EUTMR](#). The risk of detriment or unfair advantage must be serious, in the sense that it is foreseeable (i.e. not merely hypothetical) in the ordinary course of events. Therefore, it is not enough to merely show that detriment or unfair advantage cannot be excluded in general, or that it is only remotely possible. The proprietor of the earlier mark must adduce **prima facie evidence of a future risk, which is not hypothetical**, of unfair advantage or of detriment (06/07/2012, [T-60/10](#), Royal Shakespeare, EU:T:2012:348, § 53). Such a finding may be established, in particular, on the basis of logical deductions made from an analysis of the probabilities and by taking account of normal practice in the relevant commercial sector as well as of all the other circumstances of the case (10/05/2007, [T-47/06](#), Nasdaq, EU:T:2007:131, § 54, upheld on appeal 12/03/2009, [C-320/07 P](#), Nasdaq, EU:C:2009:146; 16/04/2008, [T-181/05](#), Citi, EU:T:2008:112, § 78; 14/11/2013, [C-383/12 P](#), Répresentation d'une tête de loup, EU:C:2013:741, § 42-43).

As a rule, general allegations (such as merely citing the relevant EUTMR wording) of detriment or unfair advantage will not be sufficient in themselves for proving potential

detriment or unfair advantage: the opponent must adduce evidence and/or develop a cogent line of argument to demonstrate specifically how the alleged injury might occur, taking into account both marks, the goods and services in question and all the relevant circumstances. As such, the opponent cannot merely contend that detriment or unfair advantage would be a necessary consequence flowing automatically from use of the sign applied for, owing to the strong reputation of the earlier mark, since, otherwise, marks with reputation would enjoy blanket protection against identical or similar signs for virtually any kind of product. This would be clearly inconsistent with the wording and spirit of [Article 8\(5\) EUTMR](#), because otherwise reputation would become the sole requirement, rather than being only one of several conditions.

In any event, the precise threshold of proving the risk of injury will be determined case by case. For example, where there is a claim of taking unfair advantage, it cannot be ruled out that if the mark has a high reputation and there is a proven link, the risk of injury can be more readily established.

### 3.5 Use without due cause

The last condition for the application of [Article 8\(5\) EUTMR](#) is that use of the sign applied for should be without due cause.

However, if it is established that none of the three types of injury exists, the registration and use of the mark applied for cannot be prevented, as the existence or absence of due cause for use of the mark applied for is, in those circumstances, irrelevant (22/03/2007, [T-215/03](#), Vips, EU:T:2007:93, § 60; 07/07/2010, [T-124/09](#), Carlo Roncato, EU:T:2010:290, § 51).

The existence of a cause justifying use of the trade mark applied for is a **defence** that the applicant may raise. Therefore, it **is up to the applicant to show that it has due cause to use the mark applied for**. This is an application of the general rule according to which 'he who asserts must prove', which is the expression of the ancient rule *ei qui affirmat incumbit probatio* (01/03/2004, [R 145/2003-2](#), T CARD OLYMPICS (fig.) / OLYMPIC, § 23). Case-law clearly establishes that when the proprietor of the earlier mark has shown that there is either actual and present injury to its mark or, failing that, a serious risk that such injury will occur in the future, it is for the proprietor of the later mark to establish that there is due cause for the use of that mark (06/07/2012, [T-60/10](#), Royal Shakespeare, EU:T:2012:348, § 67; 27/11/2008, [C-252/07](#), Intel, EU:C:2008:655, § 39).

In the absence of any indications in the evidence providing an apparent justification for the applicant's use of the contested mark, lack of due cause must be generally **presumed** (29/03/2012, [T-369/10](#), Beatle, EU:T:2012:177, § 76 and case-law cited therein; 14/05/2013, [C-294/12 P](#), Beatle, EU:C:2013:300, dismissing the appeal). However, the applicant may avail itself of the possibility of rebutting such a presumption by showing that it has a legitimate justification that entitles it to use the mark.

For example, such a situation could be envisaged if the applicant had been using the sign for dissimilar goods in the relevant territory before the opponent's mark was

applied for, or acquired a reputation, especially where such coexistence has not in any way affected the distinctiveness and repute of the earlier mark.

Interpreting Article 5(2) of Council Directive 89/104/EEC (whose legislative content is essentially identical to that of [Article 8\(5\) EUTMR](#)), the Court ruled that the proprietor of a trade mark with a reputation might be obliged, pursuant to the concept of ‘due cause’ within the meaning of that provision, to tolerate use by a third party of a sign similar to that mark in relation to a product that was identical to that for which that mark had been registered, if it was demonstrated that the sign was being used before the mark had been filed and that use of the sign in relation to the identical product was in good faith (06/02/2014, [C-65/12](#), Leidseplein Beheer and de Vries, EU:C:2014:49, § 60). The Court gave further detailed factors to be considered when assessing due cause on account of prior use.

The case-law below shows that due cause may be found where the applicant establishes that it cannot reasonably be required to abstain from use of the mark (for example, because its use of the sign is a generic use to indicate the type of goods and services — whether by generic words or generic figurative devices), or where it has some specific right to use the mark for the goods and services (for example, it shows that a relevant coexistence agreement permits its use of the sign).

The condition of due cause is not fulfilled merely by the fact that (a) the sign is particularly suitable for identifying the products for which it is used, (b) the applicant has already used this sign for these products or similar products within and/or outside the relevant territory of the European Union, or (c) the applicant invokes a right ensuing from a filing over which the filing of the opponent’s trade mark takes precedence (inter alia 23/11/2010, [R 240/2004-2](#), WATERFORD STELLENBOSCH (fig.) / WATERFORD; 15/06/2009, [R 1142/2005-2](#), (fig.) MARIE CLAIRE (fig.) / MARIE CLAIRE et al.). Mere use of the sign is not enough — what must be shown is a valid reason justifying that use.

### 3.5.1 Examples of due cause

#### 3.5.1.1 Due cause was accepted

Case No	Comment
02/06/2010, <a href="#">R 1000/2009-1</a> , GigaFlex / FLEX (fig.) et al., § 72	The applicant had a due cause within the meaning of <a href="#">Article 8(5) EUTMR</a> for inserting the term FLEX in the mark applied for, holding that this term was free from monopolies, since nobody holds exclusive rights in it and it is a suitable abbreviation, in many languages of the EU, to indicate that beds and mattresses are flexible.

Case No	Comment
30/07/2007, <a href="#">R 1244/2006-1</a> , MARTINI FRATELLI (fig.) / MARTINI	The applicant had two good reasons to use the name MARTINI in the mark applied for: (i) MARTINI is the family name of the founder of the applicant's company, and (ii) a coexistence agreement was signed in 1990.
20/04/2007, <a href="#">R 710/2006-2</a> , SPA et al. / CAL SPAS	The applicant had due cause to use the term SPAS as it corresponds to one of the generic uses of the term 'spa' as indicated in the judgment of 19/06/2008, <a href="#">T-93/06</a> , Mineral Spa, EU:T:2008:215.
25/08/2011, <a href="#">B 1 708 398</a> , Posten AB v Česká pošta s.p.	The applicant had due cause to use the figurative element of a postal horn since that device is widely used as a long-standing and historical symbol of postal services (trade mark registrations and internet evidence were submitted showing 29 European countries use the postal horn as a symbol for their postal services).

### 3.5.1.2 Due cause was not accepted

Case No	Comment
06/07/2012, <a href="#">T-60/10</a> , Royal Shakespeare	In order to establish due cause, it is not use per se of the contested trade mark that is required, but a reason justifying use of the trade mark. In this case, the applicant merely claimed to have 'demonstrated how and for which product the contested trade mark has been used in the past' but, even assuming that that aspect is relevant, provided no additional indication or explanation. Accordingly, the applicant had not established due cause for such use.

Case No	Comment
25/03/2009, <a href="#">T-21/07</a> , Spaline, EU:T:2009:80	There was no due cause, since it had not been shown that the word 'spa' had become so necessary to the marketing of cosmetic products that the applicant could not reasonably be required to refrain from use of the mark applied for. The argument that 'spa' was of descriptive and generic character for cosmetic products was rejected, since such character does not extend to cosmetic products 'but only to one of their uses or destinations'.
16/04/2008, <a href="#">T-181/05</a> , Citi	The use of the trade mark Citi in just one EU Member State (Spain) could not constitute due cause because, first, the extent of geographical protection of the national trade mark did not correspond to the territory covered by the trade mark applied for, and, second, the legal validity of that national registration was subject to dispute before the national courts. By the same token, the ownership of the domain 'citi.es' was held to be irrelevant.
10/05/2007, <a href="#">T-47/06</a> , Nasdaq; confirmed 12/03/2009, <a href="#">C-320/07 P</a> , Nasdaq	The only argument put forward before the Board of Appeal in respect of due cause (namely, that the word Nasdaq had been chosen because it is an acronym for 'Nuovi Articoli Sportivi Di Alta Qualità') was not convincing, noting that prepositions are not generally included in acronyms.

Case No	Comment
<p>23/11/2010, <a href="#">R 240/2004-2</a>, WATERFORD STELLENBOSCH (fig.) / WATERFORD</p>	<p>Contrary to the applicant's arguments that there was due cause because the term WATERFORD was allegedly very common in names and trade marks, the Board held that the applicant had failed to give any evidence of market coexistence of WATERFORD marks or to submit any element from which it would be possible to infer that the relevant general public (in the UK) considers Waterford as a commonplace geographical name.</p> <p>To the extent that such arguments play a role in assessing the uniqueness of a sign in order to establish whether the necessary link exists in the mind of the relevant public between the signs at issue, the Board held that, nevertheless, once such uniqueness had been established, such arguments cannot serve as due cause.</p> <p>The condition of due cause is not fulfilled merely by the fact that (a) the sign is particularly suitable for identifying the products for which it is used, (b) the applicant has already used the sign for these products or similar products within and/or outside the relevant territory of the European Union, or (c) the applicant invokes a right ensuing from a filing over which the filing of the opponent's trade mark takes precedence.</p>
<p>22/01/2015, <a href="#">T-322/13</a>, KENZO</p>	<p>The fact that the applicant's forename is Kenzo is not enough, for the purposes of <a href="#">Article 8(5) EUTMR</a>, to constitute due cause for use of the mark applied for.</p>

Case No	Comment
06/10/2006, <a href="#">R 428/2005-2</a> , TISSOT / TISSOT	The applicant's claim (unsubstantiated by any evidence) that the sign TISSOT is derived from the name of a trading company associated with the applicant's company since the early 1970s, would, even if proven, not amount, on its own, to 'due cause' within the meaning of <a href="#">Article 8(5) EUTMR</a> . People who inherit a surname that happens to coincide with a famous trade mark should not assume that they are entitled to use it in business in a manner that would unfairly take advantage of the reputation that has been built up by the efforts of the brand owner.
18/08/2005, <a href="#">R 1062/2000-4</a> , GRAMMY / GRAMMY	The argument that GRAMMY is an easy and nice-sounding abbreviation of the applicant's family name (Grammatikopoulos) was insufficient to establish due cause.



Case No	Comment
<p>15/06/2009, <a href="#">R 1142/2005-2</a>, MARIE CLAIRE (fig.) / MARIE CLAIRE et al.</p>	<p>Due cause under <a href="#">Article 8(5) EUTMR</a> means that, notwithstanding the detriment caused to, or unfair advantage taken of, the distinctive character or reputation of the earlier trade mark, registration and use by the applicant of the mark for the goods applied for may be justified if the applicant cannot be reasonably required to abstain from using the contested mark, or if the applicant has a specific right to use the mark for such goods that takes precedence over the earlier trade mark invoked in the opposition proceedings. In particular, the condition of due cause is not fulfilled merely by the fact that (a) the sign is particularly suitable for identifying the products for which it is used, (b) the applicant has already used the sign for these products or similar products within and/or outside the relevant territory of the EU, or (c) the applicant invokes a trade mark with a filing date that is earlier than the opponent's trade mark (decision of 25/04/2001, <a href="#">R 283/1999-3</a>, HOLLYWOOD).</p> <p>As regards the tolerance of the proprietor of the earlier mark, the Board held that such tolerance was merely for magazines and not for goods closer to its market sector (i.e. textiles). It noted that national case-law showed that while protection exists for each party within its own field of business, extension should be refused when they come closer to the other party's field of activities and could infringe upon their rights.</p> <p>In light of these factors, the Board held that the coexistence did not constitute due cause permitting registration of a EUTM.</p>

Case No	Comment
26/09/2012, <a href="#">T-301/09</a> , Citigate, § 116, 125 and 126	<p>Regarding the applicant's argument that it has due cause to use the mark applied for (Citigate), because it has used a variety of marks consisting of or containing Citigate in relation to the goods and services for which registration is sought, the Court stated the following: it should be noted that the documents produced by the applicant simply show that there are various companies whose business name contains the word Citigate and a number of domain names that also contain that word. That evidence is not sufficient to establish due cause, because it does not demonstrate actual use of the Citigate mark.</p> <p>As regards the applicant's argument that it has due cause to use the mark applied for since <b>the interveners have acquiesced to the use</b> of Citigate in relation to the goods and services covered by the application for registration, the Court stated that the <b>possibility cannot be excluded that, in certain cases, the coexistence of earlier marks on the market could reduce (...) the likelihood of a connection being made between two marks in accordance with <a href="#">Article 8(5) EUTMR</a>.</b></p> <p>In the present case, coexistence was not proven.</p>

Case No	Comment
01/03/2018, <a href="#">T-629/16</a> , DEVICE OF TWO PARALLEL STRIPES (other) / DEVICE OF THREE PARALLEL STRIPES (fig.) et al., EU:T:2018:108, § 192, 207-212	<p>The applicant argued that the marks at issue have, with the opponent's acquiescence, coexisted for a number of decades. However, in order to constitute due cause, the use of the mark applied for must satisfy a number of conditions.</p> <p>The applicant's argument cannot succeed where the contested mark has not been used: (i) throughout the relevant territory, (ii) peacefully and (iii) in good faith.</p> <p>In the present case the use of the slogan 'two stripes are enough' reveals that the use of the contested mark has already given rise to at least one attempt to take advantage of the repute of the earlier mark. Therefore, the use of the contested mark could not be regarded as having always been in good faith.</p>

***GUIDELINES FOR EXAMINATION OF  
EUROPEAN UNION TRADE MARKS***

***EUROPEAN UNION  
INTELLECTUAL PROPERTY OFFICE  
(EUIPO)***

***Part C***

***Opposition***

***Section 6***

***Geographical Indications (Article 8(6)  
EUTMR)***

## Table of Contents

<b>1 Introduction.....</b>	<b>1303</b>
<b>2 GIs eligible under Article 8(6) EUTMR.....</b>	<b>1304</b>
<b>2.1 GIs protected under EU law.....</b>	<b>1304</b>
2.1.1 The exhaustive nature of the EU system of protection.....	1305
<b>2.2 GIs protected under the laws of Member States.....</b>	<b>1306</b>
<b>2.3 GIs protected under international agreements.....</b>	<b>1306</b>
2.3.1 International agreements entered into by the EU.....	1306
2.3.2 International agreements entered into by Member States including the Lisbon Agreement ( ).....	1307
<b>2.4 Specifics of substantiation.....</b>	<b>1308</b>
<b>3 Scope of protection of GIs.....</b>	<b>1309</b>
<b>3.1 Situations covered by the EU Regulations.....</b>	<b>1309</b>
3.1.1 Use, including exploitation of the reputation of the GI.....	1310
3.1.2 Evocation, imitation, misuse and misleading indications and practices.....	1311
3.1.3 Limits to the scope of protection of GIs on relative grounds.....	1313
<b>3.2 Scope of protection of GIs protected under national law or         international agreements.....</b>	<b>1314</b>

## 1 Introduction

Pursuant to [Article 8\(6\) EUTMR](#), designations of origin and geographical indications protected under Union legislation or national law may be invoked in an opposition against an EUTM application. When defining the protection given to these specific designations, the regulations refer simply to the protected/registered names, regardless of whether those names refer to a protected designation of origin (PDO) or a protected geographical indication (PGI). Moreover, the scope of protection is not affected by any distinction between PDOs and PGIs. Therefore, this section will refer to these protected names as geographical indications (GIs) without making any distinction between them.

The essential function of the protection of a GI is to guarantee to the consumer the geographical origin of the goods and the special qualities connected with that origin (29/03/2011, [C-96/09 P](#), Bud, EU:C:2011:189, § 147).

Protection of GIs on relative grounds is complementary to the *ex officio* protection on absolute grounds ([Article 7\(1\)\(j\) EUTMR](#)). While there is interaction and overlaps with protection under absolute grounds, there are differences both in terms of procedure and substance arising from the relative grounds nature of protection under [Article 8\(6\) EUTMR](#).

[Article 8\(6\) EUTMR](#) reads:

Upon opposition by any person authorised under the relevant law to exercise the rights arising from a designation of origin or a geographical indication, the trade mark applied for shall not be registered where and to the extent that, pursuant to the Union legislation or national law providing for the protection of designations of origin or geographical indications:

1. an application for a designation of origin or a geographical indication had already been submitted, in accordance with Union legislation or national law, prior to the date of application for registration of the EU trade mark or the date of the priority claimed for the application, subject to its subsequent registration;
2. that designation of origin or geographical indication confers the right to prohibit the use of a subsequent trade mark.

[Article 8\(6\) EUTMR](#) is, therefore, a framework provision in the sense that it is the applicable EU legislation, Member State law or international agreement that determines the conditions of acquisition and scope of protection of the GI invoked. Furthermore, as will be explained below, the exhaustive nature of the EU system of protection of GIs in specific product areas determines the extent to which a GI protected under national law or international agreement is eligible to form the basis of an opposition under [Article 8\(6\) EUTMR](#).

For a general overview of GIs see the Guidelines, [Part B Examination, Section 4, Absolute Grounds for Refusal, Chapter 10, Trade Marks in Conflict with Geographical Indications \(Article 7\(1\)\(j\) EUTMR\)](#).

## 2 GIs eligible under Article 8(6) EUTMR

GIs are protected on various levels, under EU law, national law or international agreements, and cover various product areas such as agricultural products and foodstuffs, wines, spirits or craft and industrial products.

### 2.1 GIs protected under EU law

As regards **EU legislation** protecting GIs, the following EU regulations are currently in place:

- [Regulation \(EU\) No 1308/2013](#) <sup>(72)</sup> in respect of *wines*;
- [Regulation \(EU\) 2019/787](#) <sup>(73)</sup> in respect of *spirit drinks*;
- [Regulation \(EU\) No 1151/2012](#) <sup>(74)</sup> in respect of *agricultural products and foodstuffs*.

For more information see also the Guidelines, [Part B, Examination, Section 4, Absolute grounds for refusal, Chapter 10, Trade marks in conflict with geographical indications \(Article 7\(1\)\(j\) EUTMR\), paragraph 2, Definition of geographical indications under EU regulations](#).

GIs protected under the above Regulations may be a valid basis for an opposition under [Article 8\(6\) EUTMR](#), to the extent that they allow the person authorised under the applicable law to exercise those rights **to prevent the use** of a subsequent mark. Their ability to prevent use is governed by the relevant provisions of the Regulations cited above ([Article 13\(1\) of Regulation \(EU\) No 1151/2012](#), [Article 103\(2\) of Regulation \(EU\) No 1308/2013](#) and [Article 21 of Regulation \(EU\) 2019/787](#)). In this context, it is important to distinguish the latter provisions **preventing use** from those that **prevent registration** <sup>(75)</sup> of a trade mark, which are not a basis for opposition under [Article 8\(6\) EUTMR](#) (the provisions preventing registration are used as a basis for absolute grounds under [Article 7\(1\)\(j\) EUTMR](#)).

---

<sup>72</sup> [Regulation \(EU\) No 1308/2013](#) of the European Parliament and of the Council of 17 December 2013 establishing a common organisation of the markets in agricultural products and repealing Council Regulations (EEC) No 922/72, (EEC) No 234/79, (EC) No 1037/2001 and (EC) No 1234/2007.

<sup>73</sup> [Regulation \(EU\) 2019/787](#) of the European Parliament and of the Council of 17 April 2019 on the definition, description, presentation and labelling of spirit drinks, the use of the names of spirit drinks in the presentation and labelling of other foodstuffs, the protection of geographical indications for spirit drinks, the use of ethyl alcohol and distillates of agricultural origin in alcoholic beverages, and repealing Regulation (EC) No 110/2008.

<sup>74</sup> [Regulation \(EU\) No 1151/2012](#) of the European Parliament and of the Council of 21 November 2012 on quality schemes for agricultural products and foodstuffs, as amended by [Regulation \(EU\) 2021/2117](#) of the European Parliament and of the Council of 2 December 2021 amending Regulations (EU) No 1308/2013 establishing a common organisation of the markets in agricultural products, (EU) No 1151/2012 on quality schemes for agricultural products and foodstuffs, (EU) No 251/2014 on the definition, description, presentation, labelling and the protection of geographical indications of aromatised wine products and (EU) No 228/2013 laying down specific measures for agriculture in the outermost regions of the Union.

<sup>75</sup> [Article 14\(1\) of Regulation \(EU\) No 1151/2012](#), [Article 102\(1\) of Regulation \(EU\) No 1308/2013](#) and [Article 36\(1\) of Regulation \(EU\) 2019/787](#).

### 2.1.1 The exhaustive nature of the EU system of protection

The Court of Justice has stated that the EU system of protection for GIs for *agricultural products and foodstuffs* laid down in [Regulation \(EC\) No 510/2006](#) [then in effect] is '**exhaustive in nature**' (08/09/2009, [C-478/07](#), Budějovický Budvar, EU:C:2009:521). The Court further confirmed that the same must be true for the EU system of protection for GIs for *wines* as laid down in [Regulation \(EC\) No 1234/2007](#) [then in effect], as these 'two systems were, essentially, the same in nature, since their objectives and characteristics were similar' (14/09/2017, [C-56/16 P](#), PORT CHARLOTTE, EU:C:2017:693, § 76). For *agricultural products and foodstuffs*, see [Article 9 of Regulation \(EU\) No 1151/2012](#) read in conjunction with [recital 24 of that Regulation](#). For *wines* see [Article 107 of Regulation \(EU\) No 1308/2013](#).

The Office applies an analogous approach for GIs for *spirit drinks* for the following reasons. The former protection at national level of GIs for *spirit drinks* that now qualify for a GI under [Regulation \(EU\) 2019/787](#) was **discontinued** once those GIs were registered at EU level (see [Article 37 of Regulation \(EU\) 2019/787](#), read in conjunction with Articles [15\(2\)](#) and [20\(1\)](#) of Regulation (EC) No 110/2008).

As a result, in the areas of *agricultural products and foodstuffs, wines and spirit drinks*, protection at EU level is exhaustive in nature, which means that oppositions under [Article 8\(6\) EUTMR](#) cannot be based on national rights in these areas. This is because the EU system of protection comprising the above regulations **overrides and replaces** national protection of GIs for *agricultural products and foodstuffs, wines and spirit drinks*.

Therefore, for these products, the opponent must invoke the relevant EU legislation in the notice of opposition as the reference to national law provisions will not be considered relevant.

As an example, in two oppositions based on the GI 'Vinho Verde' the national right was invoked instead of the EU GI. As a result, the oppositions had to be rejected.

Earlier GI(s)	Comment	Case No
VINHO VERDE in Portugal (national right)	... under Article 8(6) EUTMR the opponent may not rely on a national earlier right, but merely on the right conferred under the EU system of protection of designations of origin and geographical indications for wine. (§ 99, <a href="#">R 282/2020-5</a> )	29/10/2021, <a href="#">R 126/2021-2</a> 02/10/2020, <a href="#">R 282/2020-5</a>



## 2.2 GIs protected under the laws of Member States

GIs protected under the laws of Member States may be a basis for opposition under [Article 8\(6\) EUTMR](#) but **only to the extent that no uniform EU protection is in place for the given category of goods**. This is the case, for example, for craft and industrial products (e.g. 'HEREND' for porcelain goods originating from Herend, Hungary).

In this regard, the opponent has to rely on the relevant national law which provides the protection for those national GIs. The substantiation requirements have to be observed (see [paragraph 2.4](#)).

## 2.3 GIs protected under international agreements

Notwithstanding that [Article 8\(6\) EUTMR](#) does not explicitly mention GIs protected under international agreements, the reference to 'Union legislation' and 'national law' naturally includes international agreements as they form part of the legal order of the European Union or the Member State that is a party to the international agreement.

In order for an opposition under [Article 8\(6\) EUTMR](#) to be successful on the basis of a right deriving from any international agreement, the provisions under the international agreement must be directly applicable and they must allow the beneficiary of the relevant GI to take direct legal action to prohibit the use of a subsequent trade mark.

In the latter respect, international agreements are **not always self-executing**. This depends on the characteristics of the agreement itself and on how they have been interpreted in the relevant jurisdiction. For example, the Office considers that the provisions of the Lisbon Agreement (in particular Articles 3 and 8) are not self-executing. As expressly indicated by Article 8 of the Lisbon Agreement, it is the relevant national legislation that must determine which type of legal actions may be taken, their scope and whether these legal actions include allowing the proprietor of an appellation of origin to prohibit the use of a subsequent trade mark. Therefore, in such cases, the requisite national legislation must be adduced as this is a necessary component in order for the opponent to prove that the GI in question can prevent use of the subsequent mark and that the opponent is entitled by the law governing the right to exercise this right.

### 2.3.1 International agreements entered into by the EU

GIs deriving from agreements between the EU and third countries can be invoked under [Article 8\(6\) EUTMR](#) if the provisions of these agreements vest the GI **in a particular beneficiary or a precise class of users** that have a direct right of action.

[Article 8\(6\)\(i\) EUTMR](#) requires that a GI already be applied for and be subsequently registered. However, this provision can also be applied by way of analogy to third-country GIs protected under international agreements. In the case of international agreements to which the EU is a party, the date of entry into force of the international

agreement is deemed to be the date of priority of such a GI (and in the case of a third-country GI added subsequently to the list, the date of entry into force of the relevant amendment), unless the international agreement stipulates an earlier date of priority.

The EU is a Contracting Party to the Geneva Act of the Lisbon Agreement, which entered into force on 26 February 2020. GIs originating in non-EU countries protected under the Geneva Act of the Lisbon Agreement can be relied on in oppositions under [Article 8\(6\) EUTMR](#) provided that they were granted protection in the EU by the Commission through Regulation (EU) 2019/1753 of the European Parliament and of the Council of 23/10/2019 on the action of the Union following its accession to the Geneva Act of the Lisbon Agreement on Appellations of Origin and Geographical Indications (the '[Regulation \(EU\) 2019/1753](#)') and provided that the contested trade mark was applied for after the notification of WIPO to the Commission of the international registration of the GI.

If the contested mark was applied for before the notification to the Commission of the international registration but after the filing of the international registration with the International Bureau, the GI only constitutes an earlier right if the opponent proves that the trade mark was applied for in bad faith.

The substantive law on which the opposition must rely when invoking GIs protected under the Geneva Act is Article 11(1) and (3) of the Geneva Act in conjunction with [Regulation \(EU\) 2019/1753](#). For further details, see [paragraph 3.2](#) below and the Guidelines, [Part B, Examination, Section 4, Absolute Grounds for Refusal, Chapter 10, Trade Marks in Conflict with Geographical Indications \(Article 7\(1\)\(j\) EUTMR\), paragraph 6.2.3, GI is Protected under the Lisbon System \(Geneva Act\)](#).

### 2.3.2 International agreements entered into by Member States including the Lisbon Agreement <sup>(76)</sup>

For the reasons set out in [paragraph 2.1.2](#) above, a GI protected under an international agreement concluded by Member States (either among Member States or with third countries) cannot be invoked as an earlier right under [Article 8\(6\) EUTMR](#) if it encroaches upon the exhaustive nature of EU law in the relevant areas (currently certain foodstuffs and other agricultural products, wines and spirit drinks).

In the 'Budějovický Budvar' case (08/09/2009, [C-478/07](#), Budějovický Budvar, EU:C:2009:521), the Court discussed the exhaustive nature of EU law as regards GIs originating from Member States. In the Office's interpretation, this also applies a fortiori to third-country GIs in the relevant product fields that enjoy protection in the territory of a Member State through an international agreement concluded between that Member State and a non-EU country <sup>(77)</sup>.

This equally applies to the Lisbon Agreement. In principle, appellations of origin protected in an EU Member State by virtue of the Lisbon Agreement cannot be a basis

---

<sup>76</sup> Some Member States (Bulgaria, Czech Republic, France, Italy, Hungary, Portugal and Slovakia) are party to the Lisbon Agreement for the Protection of Appellations of Origin and their International Registration of 1958 (as revised at Stockholm on 14/07/1967, and as amended on 28/09/1979).

<sup>77</sup> To which the EU is not a contracting party.

for opposition under [Article 8\(6\) EUTMR](#). The only exceptions in this regard are the following.

- International agreements that cover GIs that do not relate to agricultural products and foodstuffs, wines or spirit drinks.
- International agreements concluded with third countries by a Member State before its accession to the EU. This is because the obligations arising out of an international agreement entered into by a Member State before its accession to the EU have to be respected. However, Member States are required to take all appropriate steps to eliminate the incompatibilities between an agreement concluded before a Member State's accession and the Treaty (see Article 307 of the Treaty establishing the European Community, now [Article 351](#) (TFEU), as interpreted by the Court in its judgment of 18/11/2003, [C-216/01](#), Budějovický Budvar, EU:C:2003:618, § 168-172).
- International agreements concluded with a third country by a Member State after its accession to the EU, but before the entry into force of the uniform EU system of protection in the given product area.

As Member States are under an obligation to eliminate incompatibilities with EU law, the Office will apply the last two exceptions (which exclusively concern third country GIs in the fields of agricultural products and foodstuffs, wines or spirit drinks) **only when the opponent expressly refers to the exception and supports it by a coherent line of argument and relevant evidence** (in particular, concerning the date of entry into force of the cited international agreement in the EU Member State where protection is claimed and its continued validity). General allegations by the opponent (such as merely citing the relevant international agreement) will not be sufficient in themselves for the Office to consider that one of the latter two exceptions applies.

## 2.4 Specifics of substantiation

Pursuant to [Article 7\(2\) EUTMDR](#)<sup>78</sup>, the opponent must submit evidence of the existence and scope of protection of the earlier GI, as well as evidence of its entitlement to file the opposition. This applies to all actions, regardless of whether they are based on EU GIs, GIs protected by the laws of Member States or GIs protected by international agreements.

In particular, according to [Article 7\(2\)\(e\) EUTMDR](#), in order to substantiate its right, the opponent must provide the Office with evidence of the existence and scope of protection of the GI invoked. The opponent must also prove its entitlement to file the opposition, namely, that it is **authorised under the relevant law to exercise the rights arising from a GI** ([Article 46\(1\)\(d\) EUTMR](#) and [Article 7\(2\) EUTMDR](#)). Furthermore, the opponent must prove that the applicable law confers on it a **direct right of action** to prohibit unlawful use of a GI (see the Guidelines, [Part C, Opposition, Section 1, Opposition proceedings, paragraphs 4.2](#) and [4.2.4.4](#)).

---

<sup>78</sup> In a similar vein, [Article 16 EUTMDR](#) in relation to invalidity proceedings.

### 3 Scope of protection of GIs

#### 3.1 Situations covered by the EU Regulations

The **scope of protection of GIs protected under EU Regulations** is governed by [Article 13\(1\) of Regulation \(EU\) No 1151/2012](#), [Article 103\(2\) of Regulation \(EU\) No 1308/2013](#) and [Article 21 of Regulation \(EU\) 2019/787](#). The provisions preventing registration, [Article 14\(1\) of Regulation \(EU\) No 1151/2012](#), [Article 102\(1\) of Regulation \(EU\) No 1308/2013](#) and [Article 36\(1\) of Regulation \(EU\) 2019/787](#), are not a basis for opposition under [Article 8\(6\) EUTMR](#) (12/06/2007, [T-60/04](#) - [T-64/04](#), Bud, EU:T:2007:169, § 78); such an opposition cannot depend on whether the opponent fulfilled the conditions required to prohibit registration under the cited provisions (18/09/2015, [T-387/13](#), COLOMBIANO HOUSE / CAFE DE COLOMBIA, EU:T:2015:647, § 40 et seq.). Therefore, under [Article 8\(6\) EUTMR](#), a GI can prevail if the conditions set out in the provisions preventing use are met.

The EU regulations refer, *mutatis mutandis*, to a graduated list of prohibited acts against which GIs are protected:

1. any use of a GI (direct or indirect):
  - a. in respect of comparable products that do not comply with the product specification of a GI; or
  - b. insofar as such use exploits, weakens or dilutes<sup>79</sup> the reputation of a GI;
2. any misuse, imitation or evocation;
3. any other false or misleading indications or practices.

It must be emphasised that what applies are the specific conditions of the scope of protection as laid down in the applicable provisions and not, for example, the 'similarity of signs', 'similarity of goods and services' or 'likelihood of confusion'.

The provisions of the EU regulations preventing use contemplate situations where a GI can be invoked against goods or services that may go beyond goods and services that may be objected to under the *ex officio* examination of absolute grounds (subject to the conditions of the relevant provisions of those EU regulations). The scope of protection of GIs in an *ex officio* examination is narrower in line with the mandate contained in [Article 14 of Regulation \(EU\) No 1151/2012](#), [Article 102 of Regulation \(EU\) No 1308/2013](#) and [Article 36 Regulation \(EU\) 2019/787](#). Apart from the difference in goods that may be objected to in the absolute and relative grounds examination, the main difference is that the Office will need evidence to either assess any possible exploitation of reputation or establish that there is, indeed, a misleading indication or practice to be considered.

Detailed information on the scope of protection of GIs protected under the relevant EU regulations is included in the Guidelines, [Part B, Examination, Section 4, Absolute](#)

---

<sup>79</sup> [Regulation \(EU\) 2019/787](#) only refers to use which exploits the reputation of the protected name.

[grounds for refusal, Chapter 10, Trade marks in conflict with geographical indications \(Article 7\(1\)\(j\) EUTMR\)](#) (e.g. definitions of direct and indirect use, imitation, evocation, misuse, misleading indication and practices, objectionable products).

### 3.1.1 Use, including exploitation of the reputation of the GI

The cases involving the use of a GI for comparable products falling under [Article 13\(1\)\(a\) of Regulation \(EU\) No 1151/2012](#), [Article 103\(2\)\(a\)\(ii\) of Regulation \(EU\) No 1308/2013](#) and [Article 21\(2\)\(a\) of Regulation \(EU\) 2019/787](#) are normally part of the Office's *ex officio* assessment of absolute grounds. See also the Guidelines, [Part B, Examination, Section 4, Absolute grounds for refusal, Chapter 10, Trade marks in conflict with geographical indications \(Article 7\(1\)\(j\) EUTMR\), paragraph 4](#).

If an opponent claims in its submission that, for example, an EUTM application contains a GI and the goods applied for are comparable to those covered by that GI (or the goods constitute the specific object of services such as *retail, wholesale, import/export, provision of drink and food, production of [the product covered by the GI] for others*), the Office will, if this is indeed the case, reopen the examination on absolute grounds.

However, under [Article 13\(1\)\(a\) of Regulation \(EU\) No 1151/2012](#), [Article 103\(2\)\(a\)\(ii\) of Regulation \(EU\) No 1308/2013](#) and [Article 21\(2\)\(a\) of Regulation \(EU\) 2019/787](#), a GI can be invoked against goods and services that would not be objected to *ex officio* under absolute grounds, subject to use of the GI in the contested EUTM application and proof that such use in relation to the contested goods and services **would exploit the reputation of the GI**. On 'use of a GI' see the Guidelines, [Part B, Examination, Section 4, Absolute grounds for refusal, Chapter 10, Trade marks in conflict with geographical indications \(Article 7\(1\)\(j\) EUTMR\), paragraph 4.1](#). Therefore, the provisions regarding the exploitation of reputation of the protected name can only be relied upon when there is 'use' of a GI, and the opponent shows the possible exploitation of reputation of the GI for goods that are neither covered, nor comparable to those covered by the GI and services unrelated to the GI (as goods and services related to the GI would already be subject to objection under absolute grounds assessment).

The reputation of GIs depends on their image in the minds of consumers, and that image, in turn, depends essentially on particular characteristics and more generally on the quality of the product. It is on the quality of the product that its reputation is based (14/09/2017, [C-56/16 P](#), PORT CHARLOTTE, EU:C:2017:693, § 81-82). Therefore, contrary to the situation with trade marks, where reputation is quantitatively assessed, the reputation of a GI is linked only to the quality of the product that it designates. All registered GIs offer a guarantee of quality due to their geographical provenance. Therefore, the Office considers that GIs **are intrinsically reputed** within the meaning of [Article 13\(1\)\(a\) of Regulation \(EU\) No 1151/2012](#), [Article 103\(2\)\(a\)\(ii\) of Regulation \(EU\) No 1308/2013](#) and [Article 21\(2\)\(a\) of Regulation \(EU\) 2019/787](#) by the mere fact that they are registered. This is irrespective of whether a GI has been registered on the basis of a claim in the application to its reputation being essentially attributable to its

geographical origin ([Article 5\(2\)\(b\) of Regulation \(EU\) No 1151/2012](#), [Article 93\(1\)\(b\)\(i\) of Regulation \(EU\) No 1308/2013](#) and [Article 3\(4\) of Regulation \(EU\) 2019/787](#)).

Consequently, opponents **do not have to submit evidence of the reputation** of the GI. Nevertheless, opponents must submit **convincing arguments and/or evidence regarding the exploitation of the reputation of the GI**. The Court held that '[t]he incorporation in a trade mark of a name which is protected ... cannot be held to be capable of exploiting the reputation of that [name] ... if that incorporation does not lead the relevant public to associate that mark or the goods in respect of which it is registered with the [name] concerned or the ... product in respect of which it is protected' (14/09/2017, [C-56/16 P](#), PORT CHARLOTTE, EU:C:2017:693, § 115).

As a rule, general allegations (such as merely citing the relevant wording of the EU regulations) of exploitation of the reputation **will not be sufficient in themselves** to prove such exploitation. The opponent must adduce evidence and/or develop a cogent line of argument to demonstrate specifically how the alleged injury might occur, taking into account both the rights concerned, the goods and services in question and all the relevant circumstances.

Earlier GI(s)	Contested sign	Case No
<p><a href="#">CÍTRICOS VALENCIANOS</a> / <a href="#">CÍTRICS VALENCIANS</a> (PGI-ES-0152) for <i>orange, mandarin and lemon fruit</i></p>	 <p>EUTM application No 17 878 444 for <i>essential oils and food flavourings</i> (Classes 3 and 30)</p>	<p>24/03/2020, <a href="#">B 3 058 243</a> (exploitation of reputation)</p>
<p><i>Assessment:</i> Taking into account the presence of the terms 'citrics valencians' in the contested sign and the nature of the goods for which protection is sought (the protected citrus fruit may be ingredients of oils and aromas), and the efforts made in promoting the GI that are accredited by the opponent, when faced with the contested sign, the relevant consumers will probably associate it with the PGI '<a href="#">Cítrics Valenciens</a>' and the goods it covers. It will thus take advantage of the repute and power of attraction of the latter. The remaining elements of the contested trade mark do not prevent the association with the earlier right; on the contrary, they reinforce the association in the sense indicated by the opponent.</p>		

### 3.1.2 Evocation, imitation, misuse and misleading indications and practices

For 'evocation', 'imitation', 'misuse' and 'misleading indications and practices' see [Part B, Examination, Section 4, Absolute grounds for refusal, Chapter 10, Trade marks in conflict with geographical indications \(Article 7\(1\)\(j\) EUTMR\), paragraph 4](#), and more precisely paragraphs [4.2](#) and [4.3](#).



The Court of Justice has clarified that the concept of ‘evocation’ extends to all uses that take unfair advantage of the reputation enjoyed by the GI through association with it (09/09/2021, [C-783/19](#), Champanillo, EU:C:2021:713, § 50, see also the Opinion of the Advocate General Pitruzzella of 29/04/2021, [C-783/19](#), Champanillo, EU:C:2021:350, § 36-37). This is particularly relevant in cases based on [Article 8\(6\) EUTMR](#) where the opponent can submit the relevant evidence establishing the extent of its GI’s reputation and its potential exploitation.

Moreover, the Court of Justice clarified that the legal provisions on ‘evocation’ must be interpreted in the sense that they protect registered GIs against conducts/practices relating to both products and services, and, moreover, that there is no prerequisite that the product covered by the protected GI and the goods or services covered by the EUTM are identical or similar in order to establish evocation (09/09/2021, [C-783/19](#), Champanillo, EU:C:2021:713, § 52, 61, 66).

The following example illustrates this point:

Earlier GI(s)	Contested sign	Case No
<a href="#">PROSECCO</a> (PDO-IT-A0516) for wines	PERISECCO EUTM NO 12 788 907 registered for <i>alcoholic beverages (except beer and wine)</i> in Class 33	28/10/2021 <a href="#">R 1101/2019-1</a> (confirmed C 15 225, evocation)
<p><i>Assessment:</i> There is clearly a close visual and phonetic proximity between the PDO <a href="#">PROSECCO</a> and the contested mark PERISECCO (para. 63). The probability that the element PERISECCO [...] will directly bring to the mind of the average European consumer the PDO <a href="#">PROSECCO</a> when seeing it used for the applicant’s alcoholic beverages is particularly high (para. 65). This probability is not reduced following the partial surrender of the contested mark to -alcoholic beverages *except beers and wines*-. As reminded by the Court in the ‘Champanillo’ case (09/09/2021, <a href="#">C-783/19</a>, Champanillo, EU:C:2021:713), <a href="#">Article 103(2)(b) of Regulation No 1308/2013</a> (unlike part (a)), does not refer to comparable products. Thus, the concept of ‘evocation’ does not require that the product covered by the PDO and the product or service covered by the disputed name be identical or similar (para. 67). Bearing in mind all the circumstances of the case, in particular the outstanding reputation of the PDO <a href="#">PROSECCO</a> and the various additional circumstances regarding the marketing of the EUTM proprietor’s goods, underlined by the applicant in its submissions and in the contested decision, there is a very high probability that consumers, throughout the European Union, will establish a sufficiently clear and direct link between the term used to designate the EUTM proprietor’s products ‘PERISECCO’ and the PDO <a href="#">PROSECCO</a> (para. 71). The evocation in the mind of an average European consumer is enhanced by the fact that ‘PROSECCO’ is the name that has been used for centuries to refer to a wine originating from the area of Prosecco in the region of Trieste, and which nowadays enjoys an outstanding reputation for its wines that are now protected by the PDO ‘<a href="#">PROSECCO</a>’ (para. 72).</p>		

In cases based on [Article 8\(6\) EUTMR](#), therefore, the assessment is not limited to identical and comparable goods and related services as it is in the *ex officio* examination, which is based on the absolute grounds. Should the opponent claim in its

submission that, for example, an EUTM evokes a GI and the goods applied for are comparable to those covered by the GI (or the goods constitute the specific object of services such as *retail, wholesale, import/export, provision of drink and food, production of [the product covered by the GI] for others*), the Office will, if this is indeed the case, reopen the examination on the absolute grounds.

### 3.1.3 Limits to the scope of protection of GIs on relative grounds

The scope of protection of GIs under EU regulations cannot exceed what is required in order to safeguard the function of the GI, which is to designate goods as being from a particular **geographic origin** and as having the **special qualities connected therewith**. Unlike other signs, GIs are not used to indicate the commercial origin of goods and afford no protection in this regard.

Therefore, where the specification of an EUTM application **is limited, in relation to goods identical to the product covered by the GI, to goods in conformity with the specification of the relevant GI**, the function of the GI in question is safeguarded in relation to those products because the EUTM application only covers products from the particular **geographic origin and the special qualities connected therewith**. Consequently, an opposition against an EUTM application that has been appropriately limited will not succeed. See in this regard [Article 12\(1\) of Regulation \(EU\) No 1151/2012](#) or [Article 103\(1\) of Regulation \(EU\) No 1308/2013](#). For general information on limits to the scope of protection of GIs, see the Guidelines, [Part B, Examination, Section 4, Absolute grounds for refusal, Chapter 10, Trade marks in conflict with geographical indications \(Article 7\(1\)\(j\) EUTMR\), paragraph 4.5](#).

Earlier GI(s)	Contested sign	Case No
<p><a href="#">CAVA</a> (PDO-ES-A0735) for <i>wines</i></p>	 <p>EUTM No 16 564 271 applied for <i>wines, sparkling wines, all in conformity with the specifications of the PDO Cava.</i></p>	<p>16/10/2020, <a href="#">B 2 935 669</a> (exploitation of reputation)</p>
<p><i>Assessment:</i> Where the specification of an EUTM application is limited, in relation to goods identical to the product covered by the GI, to goods in conformity with the specification of the relevant protected GI, which is the case of the contested mark, <b>the function of the GI in question is safeguarded</b> in relation to those products because the EUTM application only covers products from the particular geographic origin and the special qualities connected therewith.</p>		



### 3.2 Scope of protection of GIs protected under national law or international agreements

The scope of protection of GIs protected under national law or international agreements, including agreements concluded by the EU with third countries, is **governed by the relevant provisions** (e.g. for the abovementioned Hungarian GI 'HEREND', by Article 109 of Act XI of 1997 on the protection of trade marks and geographical indications; for the GI '[Mezcal](#)', by the relevant provisions of the Agreement between the European Community and the United Mexican States on the mutual recognition and protection of designations for spirit drinks (OJ L 152, 11.06.1997, page 16). The substantive provisions of the agreement concerned may for instance include specific requirements or authorisation for the use of the protected term. See also the Guidelines, [Part B, Examination, Section 4, Absolute grounds for refusal, Chapter 10, Trade marks in conflict with geographical indications \(Article 7\(1\)\(j\) EUTMR\), paragraph 6.2.](#)

As regards the scope of protection of GIs protected under the Geneva Act to which the European Union is a contracting party, and in particular its Article 11, please see the Guidelines, [Part B, Examination, Section 4, Absolute grounds for refusal, Chapter 10, Trade marks in conflict with geographical indications \(Article 7\(1\)\(j\) EUTMR\), paragraph 6.2.3, GI is protected under the Lisbon System \(Geneva Act\).](#)

The Office considers that in spite of the different wording of Article 11(1) of the Geneva Act, the scope of protection corresponds to that of the GIs protected under the EU Regulations (i.e. against direct and indirect use of the GI for the same and comparable products, exploitation, weakening and dilution of reputation of the GI, misuse, imitation or evocation or other misleading indications and practices). In addition, the Office considers that the notion of 'goods that are not of the same kind' is analogous to the notion of 'non-comparable goods' under the EU Regulations providing for the protection of GIs. The Office will therefore apply the same standard to GIs protected under the Geneva Act and will examine potential conflict with earlier GIs, bearing in mind, *mutatis mutandis*, the rules contained above in the Guidelines, [Part B, Examination, Section 4, Absolute grounds for refusal, Chapter 10, Trade marks in conflict with geographical indications \(Article 7\(1\)\(j\) EUTMR\), paragraph 4, Situations covered by the EU Regulations and absolute grounds examination.](#)

Finally, unlike in the *ex officio* examination of absolute grounds of refusal, an opposition based on [Article 8\(6\) EUTMR](#) can be successful against goods and services that are not comparable to those for which the GI is protected, provided that the opponent submits evidence and arguments to prove that either Article 11(1)(a)(ii) or Article 11(1)(b) of the Geneva Act apply to such non-comparable goods or services. In this regard the Office will apply the same standard as in the examination of cases based on [Article 8\(6\) EUTMR](#) and invoking EU GIs as basis (see [paragraph 3.1](#) above).

***GUIDELINES FOR EXAMINATION OF  
EUROPEAN UNION TRADE MARKS***

***EUROPEAN UNION  
INTELLECTUAL PROPERTY OFFICE  
(EUIPO)***

***Part C***

***Opposition***

***Section 7***

***Proof of use***

## Table of Contents

<b>1 Introduction.....</b>	<b>1319</b>
<b>1.1 Function of proof of use.....</b>	<b>1319</b>
<b>1.2 Legislative framework.....</b>	<b>1319</b>
<b>2 General principles and standard of proof.....</b>	<b>1322</b>
<b>2.1 General principles.....</b>	<b>1322</b>
<b>2.2 Standard of proof.....</b>	<b>1323</b>
<b>3 Place of use.....</b>	<b>1325</b>
<b>3.1 Use on the ‘domestic’ market.....</b>	<b>1325</b>
<b>3.2 EUTMs: use in the European Union.....</b>	<b>1325</b>
<b>3.3 National marks: use in the relevant Member State.....</b>	<b>1327</b>
<b>3.4 Use in the import and export trade.....</b>	<b>1327</b>
<b>4 Time of use.....</b>	<b>1329</b>
.....	1329
.....	1330
<b>5 Extent of use.....</b>	<b>1330</b>
<b>5.1 Criteria.....</b>	<b>1330</b>
<b>5.2 Examples of insufficient use.....</b>	<b>1332</b>
<b>5.3 Examples of sufficient use.....</b>	<b>1335</b>
<b>6 Nature of use.....</b>	<b>1338</b>
<b>6.1 Use as a trade mark .....</b>	<b>1339</b>
6.1.1 Use of a mark in accordance with its function.....	1339
6.1.1.1 Use of individual marks.....	1339
6.1.1.2 Use of collective and certification marks.....	1341
6.1.2 Use in the course of trade.....	1342
6.1.2.1 Public use versus internal use.....	1342
6.1.2.2 Commercial activity versus promotional activity.....	1343
6.1.2.3 Use in relation to goods.....	1343
6.1.2.4 Use in relation to services.....	1344
6.1.2.5 Use in advertising.....	1345
6.1.2.6 Use on the internet.....	1347
<b>6.2 Use of the mark as registered or of a variation thereof.....</b>	<b>1350</b>

6.2.1 Use in the form as registered – simultaneous use of independent marks.....	1350
6.2.2 Use in a form different from the one registered.....	1354
6.2.2.1 Additions.....	1355
6.2.2.2 Omissions.....	1365
6.2.2.3 Modification of other characteristics.....	1375
<b>6.3 Use in connection with the registered goods and services.....</b>	<b>1378</b>
6.3.1 Comparison between goods/services used and specification of goods/ services.....	1379
6.3.2 Relevance of the classification.....	1381
6.3.3 Use and registration for general indications in ‘class headings’.....	1382
6.3.4 Use for subcategories of goods/services and similar goods/services.....	1382
6.3.4.1 Earlier mark registered for broad category of goods/services.....	1383
6.3.4.2 Earlier mark registered for precisely specified goods/services.....	1385
6.3.4.3 Examples.....	1385
6.3.5 Use of the mark on integral parts, aftersales services and second-hand market of the registered goods.....	1390
6.3.6 Use for the sale of the manufacturer’s own goods.....	1391
<b>7 Use by the proprietor or on its behalf.....</b>	<b>1393</b>
<b>7.1 Use by the proprietor.....</b>	<b>1393</b>
<b>7.2 Use by authorised third parties.....</b>	<b>1393</b>
<b>7.3 Use of collective and certification marks by authorised users.....</b>	<b>1394</b>
<b>8 Irrelevance of unlawful use.....</b>	<b>1394</b>
<b>9 Justification of non-use.....</b>	<b>1394</b>
<b>9.1 Business risks.....</b>	<b>1395</b>
<b>9.2 Government or court intervention.....</b>	<b>1395</b>
<b>9.3 Defensive registrations.....</b>	<b>1397</b>
<b>9.4 Force majeure.....</b>	<b>1397</b>
<b>9.5 Consequences of justification of non-use.....</b>	<b>1398</b>
<b>10 Decision.....</b>	<b>1398</b>
<b>10.1 Competence of the Office.....</b>	<b>1398</b>
<b>10.2 Need for assessing proof of use.....</b>	<b>1399</b>
<b>10.3 Overall assessment of the evidence presented.....</b>	<b>1399</b>
<b>10.4 Treatment of confidential information.....</b>	<b>1400</b>
<b>10.5 Examples.....</b>	<b>1401</b>
10.5.1 Genuine use accepted.....	1401

10.5.2 Genuine use not accepted..... 1405

# 1 Introduction

## 1.1 Function of proof of use

European Union legislation on trade marks establishes an obligation for the owner of a registered trade mark **to use** that mark in a genuine manner. The owner must put the mark to genuine use within a period of 5 years following its registration ([Article 18\(1\) EUTMR](#)). However, the owner has a 'grace period' of 5 years after registration, during which it cannot be required to demonstrate use of the mark in order to rely upon it — including in opposition proceedings before the Office. During the grace period, the mere formal registration gives the mark full protection. Once this period lapses, the owner may be required **to prove genuine use** of the earlier mark.

The reason behind the requirement that earlier marks must be put to genuine use is to restrict the number of trade marks registered and protected and, consequently, the number of conflicts between them (12/03/2003, [T-174/01](#), Silk Cocoon, EU:T:2003:68, § 38).

When it comes to the requirement to prove use in opposition proceedings before the Office, it is important to bear in mind that the purpose of [Article 47\(2\) and \(3\) EUTMR](#) is not to assess commercial success or to review the economic strategy of an undertaking, nor is it to restrict trade-mark protection to only large-scale commercial use of the marks (08/07/2004, [T-334/01](#), Hipoviton, EU:T:2004:223, § 32; 08/07/2004, [T-203/02](#), Vitafruit, EU:T:2004:225, § 38).

The Office does not inquire *ex officio* whether the earlier mark has been used. Such examination takes place only when the EUTM applicant makes an explicit request for proof of use. Such a request, if the legal requirements are met, triggers the procedural and substantive consequences laid down in the EUTMR, EUTMDR and EUTMIR.

## 1.2 Legislative framework

The legislative framework consists of provisions of the EUTMR, the EUTMDR, the EUTMIR and Directive (EU) 2015/2436 approximating the laws of the Member States relating to trade marks <sup>(80)</sup>([the Directive](#)), as implemented in the national law of the Member States.

### [Article 18 EUTMR](#)

[Article 18 EUTMR](#) stipulates the basic substantive requirement for the obligation to use registered marks:

If, within a period of five years following registration, the proprietor has not put the EU trade mark to genuine use in the Union in connection with the goods or services in

---

<sup>80</sup> [Directive \(EU\) 2015/2436 of the European Parliament and of the Council of 16 December 2015 to approximate the laws of the Member States relating to trade marks](#)

respect of which it is registered, or if such use has been suspended during an uninterrupted period of five years, the EU trade mark shall be subject to the sanctions provided for in this Regulation, unless there are proper reasons for non-use.

[Article 18\(1\)\(a\) EUTMR](#) states that use of the EU trade mark in a form differing in elements which do not alter the distinctive character of the mark in the form in which it was registered constitutes use. This applies regardless of whether or not the trade mark in the form as used is also registered in the name of the proprietor. [Article 18\(1\)\(b\) EUTMR](#) states that affixing the EU trade mark to goods or to the packaging of goods in the Union also constitutes use, even when solely for export purposes.

According to [Article 18\(2\) EUTMR](#), use of the EUTM with the consent of the proprietor will be deemed to constitute use by the proprietor.

#### [Article 47\(2\) and \(3\) EUTMR](#)

The consequences of a lack of use in opposition proceedings are dealt with in [Article 47\(2\) and \(3\) EUTMR](#):

If the applicant so requests, the proprietor of an earlier EU trade mark who has given notice of opposition shall furnish proof that, during the five-year period preceding the date of filing or the date of priority of the EU trade mark application, the earlier EU trade mark has been put to genuine use in the Union in connection with the goods or services in respect of which it is registered and which he cites as justification for his opposition, or that there are proper reasons for non-use, provided the earlier EU trade mark has at that date been registered for not less than five years. In the absence of proof to this effect, the opposition shall be rejected. If the earlier EU trade mark has been used in relation to only part of the goods or services for which it is registered it shall, for the purposes of the examination of the opposition, be deemed to be registered in respect only of that part of the goods or services.

Paragraph 2 shall apply to earlier national trade marks referred to in [Article 8\(2\)\(a\)](#), by substituting use in the Member State in which the earlier national trade mark is protected for use in the Union.

It follows from the wording of [Article 47\(2\) and \(3\) EUTMR](#) that proof of use can only be requested if the earlier right is an **EUTM** or other **trade mark** having effect in the EU or an EU Member State, as defined in [Article 8\(2\)\(a\) EUTMR](#). Since oppositions brought under [Article 8\(4\) EUTMR](#) cannot be based on either EUTMs or other trade marks referred to in [Article 8\(2\)\(a\) EUTMR](#), the EUTM applicant is not entitled to request proof of use for earlier rights relied upon in oppositions brought under this provision. Nevertheless, [Article 8\(4\) EUTMR](#) requires the opponent to prove use in the course of trade of more than mere local significance for the earlier rights in question.

As for [Article 8\(3\) EUTMR](#), no request for proof of use can be made under [Article 47\(2\) or \(3\)](#) for any of the earlier marks relied on. The reason is that the earlier marks eligible under [Article 8\(3\) EUTMR](#) include both trade marks having effect in the EU **and** outside the EU, requests for proof of use of the latter not being possible under the EUTMR. It would be discriminatory to request proof of use for some countries' trade marks but not for others. In any event, it follows from the specific requirement under [Article 8\(3\) EUTMR](#) to establish a principal / agent relationship, that, in principle, the

earlier mark has normally been put to use by the applicant, under authorisation, and so on behalf, of the proprietor of the earlier mark.

#### [Article 10 EUTMDR](#) and [Article 24 EUTMIR](#)

In accordance with [Article 10\(2\) EUTMDR](#), where, pursuant to [Article 47\(2\) or \(3\) EUTMR](#), the opponent has to submit proof of use or show that there are proper reasons for non-use, the Office will invite the opponent to provide the proof required within a period specified by the Office. If the opponent does not provide such proof before the time limit expires, the Office will reject the opposition.

In accordance with [Article 10\(3\) EUTMDR](#), the indications and evidence required to prove use must consist of indications concerning the place, time, extent and nature of use of the opposing trade mark for the goods and services in respect of which it is registered and on which the opposition is based, and evidence in support of these indications in accordance with paragraph 4.

In accordance with [Article 10\(4\) EUTMDR](#), the evidence must consist of written documents and in principle be confined to supporting documents and items such as packages, labels, price lists, catalogues, invoices, photographs, newspaper advertisements, and statements in writing as referred to in [Article 97\(1\)\(f\) EUTMR](#).

In accordance with [Article 10\(5\) EUTMDR](#), a request for proof of use may be submitted at the same time as observations on the grounds on which the opposition is based. Such observations may also be filed together with the observations in reply to the proof of use.

As regards language, the general rules relating to supporting documents to be used in written proceedings before the Office apply, as provided for in [Article 24 EUTMIR](#). As such, the evidence of use may be submitted in any official language of the European Union. Nevertheless, in accordance with [Article 10\(6\) EUTMDR](#), where the evidence submitted is not in the language of the opposition proceedings, the Office may require the opponent to submit a translation of the evidence in that language, within a period specified by the Office.

#### [The Directive](#)

[Articles 16\(1\), \(5\) and \(6\) of the Directive](#) contain provisions relating to trade marks having effect in a Member State substantially identical to [Article 18 EUTMR](#).

[Articles 16\(2\), \(3\) and \(4\) of the Directive](#) are relevant for the purposes of determining the grace period for non-use of trade marks having effect in a Member State.

This section of the Guidelines deals with the **substantive** aspects of proving genuine use. The **procedural** aspects of proof of use are dealt with in the Guidelines, [Part C, Opposition, Section 1, Opposition Proceedings, paragraph 5](#).



## 2 General principles and standard of proof

### 2.1 General principles

The EUTMR, the EUTMDR and the EUTMIR do not define what is to be regarded as 'genuine use'. However, the Court of Justice (the 'Court') has laid down several important principles as regards the interpretation of this term.

In *Minimax* (11/03/2003, [C-40/01](#), *Minimax*, EU:C:2003:145), the Court established the following principles:

- genuine use means **actual** use of the mark (paragraph 35);
- genuine use must, therefore, be understood to denote use that is **not merely token**, serving solely to preserve the rights conferred by the mark (paragraph 36);
- genuine use must be consistent with the **essential function** of a trade mark, which is to guarantee the identity of the origin of goods or services to the consumer or end user by enabling the latter, without any possibility of confusion, to distinguish the product or service from others that have another origin (paragraph 36);  
(<sup>81</sup>)
- genuine use entails use of the mark **on the market** for the goods or services protected by that mark and not just internal use by the undertaking concerned (paragraph 37);
- genuine use must relate to **goods or services** already marketed or about to be marketed and for which preparations by the undertaking to secure customers are under way, particularly in the form of advertising campaigns (paragraph 37);
- when assessing whether there has been genuine use, regard must be had to all the facts and circumstances relevant to establishing whether the commercial exploitation of the mark is **real**, in particular whether such use is viewed as warranted in the economic sector concerned to **maintain or create a share in the market** for the goods or services protected by the mark (paragraph 38);
- the circumstances of the case may, therefore, include giving consideration, inter alia, to the **nature** of the goods or services at issue, the **characteristics of the market** concerned and the scale and **frequency** of use of the mark (paragraph 39);
- use need **not**, therefore, always be **quantitatively significant** for it to be deemed genuine, as that depends on the characteristics of the goods or services concerned on the corresponding market (paragraph 39).

In its order of 27/01/2004, [C-259/02](#), *Laboratoire de la mer*, EU:C:2004:50, the Court further elaborated the *Minimax* criteria as follows:

- the question whether use is sufficient to preserve or create market share for the goods or services concerned depends on several factors and on a case-by-case assessment. The **characteristics** of the goods and services, the **frequency or**

---

<sup>81</sup> The criterion of 'identity of origin' applies only to individual marks. As regards the essential function of collective and certification marks and the consequences for assessing genuine use, see [paragraph 6.1.1.2](#) below.

**regularity** of the use of the mark, whether the mark is used for the purpose of marketing **all** the identical goods or services of the proprietor or merely some of them, or evidence that the proprietor is able to provide, are among the factors that may be taken into account (paragraph 22);

- use of the mark by a single client that **imports** the goods for which the mark is registered can be sufficient to demonstrate that such use is genuine, if it appears that the import operation has a genuine commercial justification for the proprietor of the mark (paragraph 24);
- a **de minimis** rule cannot be laid down (paragraph 25).

**Fast-track: 31/03/2023**

## 2.2 Standard of proof

[Article 47 EUTMR](#) requires **proof** of genuine use of the earlier mark. Genuine use of a trade mark cannot be proved by means of probabilities or suppositions, but must be demonstrated by solid and objective evidence of effective and sufficient use of the trade mark on the market concerned (18/01/2011, [T-382/08](#), Vogue, EU:T:2011:9, § 22).

Moreover, the Office cannot determine *ex officio* the genuine use of earlier marks. Even proprietors of purportedly well-known marks must submit evidence to prove genuine use of the earlier mark(s).

The Office does not necessarily require a high threshold of proof of genuine use. The Court has indicated that it is not possible to prescribe, in the abstract, **what quantitative threshold should be chosen** in order to determine whether use was genuine or not, and accordingly there can be no objective *de minimis* rule to establish a priori the level of use needed in order for it to be 'genuine'. So, whilst a minimum extent of use must be shown, what exactly constitutes this minimum extent depends on the circumstances of each case. The general rule is that, when it serves a real commercial purpose, **even minimal use of the trade mark could be sufficient to establish genuine use**, depending on the goods and services, and the **relevant market** (23/09/2009, [T-409/07](#), acopat, EU:T:2009:354, § 35 and case-law cited therein; 02/02/2012, [T-387/10](#), Arantax, EU:T:2012:51, § 42).

In other words, it is sufficient if the evidence of use proves that the trade mark owner has seriously tried to acquire or maintain a commercial position in the relevant market. However, not just any proven commercial exploitation can automatically be qualified as genuine use of the mark in question (17/07/2014, [C-141/13 P](#), Walzer Traum, EU:C:2014:2089, § 32). Use may still be insufficient even where commercial exploitation has been proven to a certain extent.

According to [Article 10\(3\) EUTMDR](#), the indications and evidence required in order to provide proof of use must concern the **place, time, extent and nature of use** of the opponent's trade mark for the relevant goods and services.

These requirements for proof of use are **cumulative** (05/10/2010, [T-92/09](#), STRATEGI / Stratégies, EU:T:2010:424, § 43). This means that the opponent is obliged

not only to indicate but also to prove each of these requirements. However, the sufficiency of the indication and proof as to the place, time, extent and nature of use has to be considered in view of the **entirety** of the evidence submitted. A separate assessment of the various relevant factors, each considered in isolation, is not suitable (17/02/2011, [T-324/09](#), Friboi, EU:T:2011:47, § 31).

Thus, the Office evaluates the evidence submitted in **an overall assessment**. All the circumstances of the specific case have to be taken into account and all the materials submitted must be assessed **in conjunction with each other**. Therefore, although pieces of evidence may be insufficient by themselves to prove the use of an earlier trade mark, they may contribute to proving use in combination with other documentation and information.

Evidence of use may be **of an indirect/circumstantial nature**, such as evidence about the share in the relevant market, the importing of the relevant goods, the supply of the necessary raw materials or packaging to the owner of the mark, or the expiry date of the relevant goods. Such indirect evidence can play a decisive role in the overall assessment of the evidence submitted. Its probative value has to be carefully assessed. For instance, the judgment of 08/07/2010, [T-30/09](#), Peerstorm, EU:T:2010:298, § 42 et seq. found that catalogues in themselves could — under certain circumstances — be conclusive evidence of sufficient extent of use.

It is necessary to take into account **the specific kind of the goods and services involved** when assessing the probative value of the evidence submitted. For example, it may be common in a particular market sector for the samples of the goods and services themselves not to bear indications of the place, time, extent and nature of use. In these cases it is obviously inappropriate to disregard such evidence of use if indications in this respect can be found in the other evidence submitted.

Each of the documents submitted has to be carefully evaluated as to whether it really reflects use in the 5 years preceding the date of filing or the date of priority of the EUTM application (see [paragraph 4](#) below) and use in the relevant territory (see [paragraph 3](#) below). <sup>(82)</sup> In particular, the dates and place of use shown on orders, invoices and catalogues are carefully examined.

Material submitted **without any indication of date of use** may, in the context of an overall assessment, still be relevant and taken into consideration **in conjunction with other pieces** of evidence that are dated (17/02/2011, [T-324/09](#), Friboi, EU:T:2011:47, § 33). This is the case in particular if it is common in a particular market sector for the samples of the goods and services themselves not to bear indications of time (05/09/2001, [R 608/2000-4](#), PALAZZO / HELADERIA PALAZZO, § 16, noting that ice-cream menus are rarely dated).

For implementation of the abovementioned general principles in practice, see the examples in [paragraph 10.5](#) below.

---

<sup>82</sup> Publication date of the contested EUTM application in the event of EUTM applications filed before 23/03/2016, see [paragraph 4.2](#) below.

### 3 Place of use

#### 3.1 Use on the ‘domestic’ market

Trade marks must be used in the territory where they are protected (European Union for EUTMs, the territory of the Member State for national marks or Benelux for Benelux marks, and the territories of the relevant countries for international registrations).

As the Court held in para. 30 of *Leno Marken*, its judgment of 19/12/2012, [C-149/11](#), *Onel / Omel*, EU:C:2012:816, ‘the territorial scope of the use is only one of several factors to be taken into account in the determination of whether that use is genuine or not’. The Court further indicated that use of the mark in non-EU territories cannot be taken into account (para. 38).

In view of the globalisation of trade, an indication of the registered seat of the owner of the mark may not be regarded as sufficient indication that the use has taken place in that particular country. Even though [Article 18\(1\)\(b\) EUTMR](#) stipulates that the affixing of the trade mark to goods or to the packaging thereof in the European Union solely for export purposes is considered as use of the mark, mere indication of the opponent’s seat as such does not constitute evidence of such acts. On the other hand, the fact that clients that have their seats outside the relevant territory are listed in the documents for proving use of the earlier mark is in itself not sufficient to rule out that services (e.g. promotion services) may actually have been rendered in the relevant territory for the benefit of these companies located in other territories (09/06/2010, [R 952/2009-1](#), *GLOBAL (fig.) / GLOBAL TABACOS (fig.)*, § 16).

#### 3.2 EUTMs: use in the European Union

If the earlier mark is a European Union mark, it must be used ‘in the Union’ (Articles [18\(1\)](#) and [47\(2\)](#) EUTMR). Following *Leno Marken*, [Article 18\(1\) EUTMR](#) must be interpreted as meaning that the territorial borders of the Member States should be disregarded when assessing whether an EUTM has been put to ‘genuine use’ in the European Union (§ 44).

In territorial terms and in view of the unitary character of the EUTM, the appropriate approach is not that of political boundaries but of market(s). Moreover, one of the aims pursued by the EUTM system is to be open to businesses of all kinds and sizes. Therefore, the size of an undertaking is not a relevant factor for establishing genuine use.

As the Court indicated in *Leno Marken*, it is impossible to determine a priori and in the abstract what territorial scope should be applied in order to determine whether use of the mark is genuine or not (§ 55). Territorial scope is only one of several factors to be taken into account when assessing whether use of an EUTM is genuine. Furthermore,

a *de minimis* rule for establishing whether that factor is satisfied cannot be laid down (07/11/2019, [T-380/18](#), INTAS / INDAS (fig.) et al., EU:T:2019:782, § 80).

An EUTM need not be used in an extensive geographic area for use to be deemed genuine, since this will depend on the characteristics of the goods or services concerned on the corresponding market and, more generally, on all the facts and circumstances relevant to establishing whether commercial exploitation of the mark serves to create or maintain market shares for the goods or services for which it was registered (19/12/2012, [C-149/11](#), Onel / Omel, EU:C:2012:816, § 55; 07/11/2019, [T-380/18](#), INTAS / INDAS (fig) et al., EU:T:2019:782 § 80).

All the relevant facts and circumstances must be taken into account, including the characteristics of the market concerned, the nature of the goods or services protected by the trade mark and the territorial extent and scale of the use as well as its frequency and regularity (19/12/2012, [C-149/11](#), Onel / Omel, EU:C:2012:816, § 58).

Moreover, for use of an EUTM to be deemed genuine, the mark need not be used in a substantial part of the European Union. The possibility that it may have been used in the territory of only a single Member State must not be ruled out, since the borders of the Member States must be disregarded while the characteristics of the goods or services concerned must be taken into account (07/11/2019, [T-380/18](#), INTAS / INDAS (fig) et al., EU:T:2019:782, § 80).

The General Court has held on numerous occasions that use of an EUTM in a single Member State (for example, in Germany, in Spain, or in the United Kingdom), or even in a single city in a Member State of the European Union, is sufficient to satisfy the criterion of territorial scope (07/11/2019, [T-380/18](#), INTAS / INDAS (fig) et al., EU:T:2019:782, § 81 and the case-law cited).

For example, use of an EUTM in the United Kingdom (15/07/2015, [T-398/13](#), TVR ITALIA (fig.) / TVR et al., EU:T:2015:503, § 57) or even in London and its immediate surroundings may be geographically sufficient (30/01/2015, [T-278/13](#), now, EU:T:2015:57). The Board of Appeal decision of 07/03/2013, [R 234/2012-2](#), now (fig.) (confirmed 30/01/2015, [T-278/13](#), now, EU:T:2015:57), considered the use of an EUTM for wireless broadband services in Class 42 **in the geographical area comprising London and the Thames Valley** sufficient to constitute genuine use in the United Kingdom and also in the European Union, taking into account the territorial extent [London being ‘the largest city in the United Kingdom and the largest urban zone in the European Union’, having ‘a metropolitan area ... with an estimated total population of between 12 million and 14 million people’, being ‘the world’s leading financial centre along with New York’, ‘a leading centre of arts, science, tourism and media and information technology’, and having a profile on the European commercial scene ‘disproportionately high in respect to the services in question’ ([R 234/2012-2](#), § 47), and the Thames Valley being ‘200 miles long and 30 miles wide’ and including ‘populous towns and cities of significant economic activity’ ([R 234/2012-2](#), § 45-46)], the scale, frequency and regularity of use and the characteristics of the market concerned ([R 234/2012-2](#), § 52).

In other words, whether an EUTM has been used in one Member State or several is irrelevant. What matters is the impact of use in the internal market and, more specifically, whether it is sufficient to maintain or create market share in that market for the goods and services covered by the mark and whether it contributes to a commercially relevant presence of the goods and services in that market. Whether that use results in actual commercial success is not relevant (07/11/2019, [T-380/18](#), INTAS / INDAS (fig) et al., EU:T:2019:782, § 82).

The Office must determine on a case-by-case basis whether the various indications and evidence can be combined for the purpose of assessing the genuine character of use, the geographical dimension of which is only one of the aspects to be considered.

In any event, it must be underlined that the European requirements or standards for genuine use are applicable (i.e. the conditions of [Article 18 EUTMR](#)) and not national standards or practices applied to EUTMs.

### 3.3 National marks: use in the relevant Member State

If the earlier mark is a national mark with effect in one of the Member States of the European Union, the mark must have been genuinely used in the country where it is protected ([Article 47\(3\) EUTMR](#)). Use in a part of the Member State, provided it is genuine, may be considered sufficient:

Case No	Earlier trade mark	Comment
11/05/2006, <a href="#">C-416/04 P</a> , Vitafruit	VITAFRUT	Use considered sufficient, even though the earlier Spanish mark was not present in a substantial part of the territory of Spain as the evidence referred to the sale of everyday consumer goods (concentrated fruit juices) to only a single customer in Spain (paras 60, 66 and 76).

If the earlier mark is an international mark or a Benelux mark, the mark must have been genuinely used in the territory of the relevant countries of the international registration or in Benelux, respectively.

### 3.4 Use in the import and export trade

According to [Article 18\(1\)\(b\) EUTMR](#), the affixing of the European Union trade mark to goods or to the packaging thereof in the European Union solely for **export** purposes also constitutes use within the meaning of [Article 18\(1\) EUTMR](#). The mark has to be

used (i.e. affixed to goods or their packaging) in the relevant market — that is, the geographical area where it is registered.

Case No	Earlier trade mark	Comment
04/06/2015, EU:T:2015:156 <a href="#">T-254/13</a> ,	STAYER	Genuine use may result from the export to a single operator located outside Europe, who can be an intermediary, for the purpose of selling to the end consumer in a non-EU country. Proof that the products have been put on the market in the non-EU importing country is not required (paras 57-61).
14/07/2010, <a href="#">R 602/2009-2</a>	RED BARON	The Board indicated that sales in Austria and Great Britain from the Netherlands also constituted genuine use in the Netherlands (para. 42).

Evidence relating only to the **import** of the goods in the relevant area may, depending on the circumstances of the case, suffice as proof of use in this area (see by analogy 09/07/2010, [T-430/08](#), Grain Millers, EU:T:2010:304, § 33, 40 et seq. regarding proof of use in the course of trade of a sign, on the basis of imports from Romania to Germany).

The Court has held that **transit**, which consists in transporting goods lawfully manufactured in a Member State to a non-member country by passing through one or more Member States, does not involve any marketing of the goods in question and is therefore not liable to infringe the specific subject matter of the trade mark (regarding the transit through France of goods originating in Spain and destined for Poland, see judgments of 23/10/2003, [C-115/02](#), Rioglass and Transremar, EU:C:2003:587, § 27; 09/11/2006, [C-281/05](#), Diesel, EU:C:2006:709, § 19). Therefore, mere transit through a Member State cannot constitute genuine use of the earlier mark in that territory (09/12/2015, [T-354/14](#), ZuMEX (fig.) / JUMEX, EU:T:2015:947, § 62).



## 4 Time of use

**Fast-track: 31/03/2023**

### 4.1 **Contested EUTM applications and International registrations designating the EU filed on or after 23/03/2016**

If the earlier mark is subject to the use requirement at all (registered for not less than 5 years), the actual period for which use must be shown can simply be computed backwards from the **filing or**, if the contested EUTM application has a priority date, **from the priority date** of the contested EUTM application. For example, if the contested EUTM application was filed on 15/06/2016, or if this date was the priority date of the contested EUTM application, the opponent would have to prove genuine use of its mark within the period from 15/06/2011 to 14/06/2016.

If the contested mark is an international registration designating the European Union, the actual period for which use must be proven can simply be computed backwards from the date of registration (INID code 151) or the date of priority (INID code 300), or, as the case may be, the date of subsequent designation of the European Union (INID code 891). For example, if the contested international registration were registered, or if the European Union were subsequently designated, on 15/06/2016, the opponent would have to prove genuine use of its mark within the period from 15/06/2011 to 14/06/2016.

Evidence referring to use made outside the relevant time frame is in general immaterial, unless it constitutes conclusive indirect proof that the mark must have also been put to genuine use during the relevant period. The Court held in this context that circumstances subsequent to the relevant point of time may make it possible to confirm or better assess the extent to which the trade mark was used during the relevant period and the real intentions of the proprietor during that time (27/01/2004, [C-259/02](#), *Laboratoire de la mer*, EU:C:2004:50, § 31).

Where a mark has not been genuinely used for more than 5 years before the filing or priority date of the contested EUTM application, the fact that there may be remaining goodwill or knowledge of the mark in the mind of the trade or customers does not 'save' the mark.

The use need not have been made throughout the period of 5 years, but rather within the 5 years. The provisions on the use requirement do not require continuous use (16/12/2008, [T-86/07](#), *Deitech*, EU:T:2008:577, § 52).



**Fast-track: 31/03/2023**

## **4.2 Contested EUTM applications and International registrations designating the EU filed before 23/03/2016**

For contested EUTM applications and International registrations designating the EU filed before 23/03/2016, the regime for calculating the relevant period prior to the entry into force of [Amending Regulation \(EU\) 2015/2424](#) applies, according to which the 5-year period has to be computed backwards from the **date of publication** of the contested EUTM application. In the case of contested IRs designating the EU, the equivalent date is the date of first publication of the IR or its subsequent designation in the EUTM Bulletin (25/04/2018, [T-312/16](#), CHATKA / CHATKA (fig.), EU:T:2018:221, § 19-42).

## **5 Extent of use**

### **5.1 Criteria**

In this regard, it has to be evaluated whether, in view of the market situation in the particular industry or trade concerned, it can be deduced from the material submitted that **the owner has seriously tried to acquire a commercial position in the relevant market**. The trade mark has to be used for goods or services already marketed or about to be marketed and for which preparations by the undertaking to secure customers are under way, particularly in the form of advertising campaigns (11/03/2003, [C-40/01](#), Minimax, EU:C:2003:145, § 37). This does not mean that the opponent has to reveal the total volume of sales or turnover figures.

Concerning the extent of use made of the earlier mark, account must be taken, in particular, of the **commercial volume** of all the acts of use on the one hand and the **duration** of the period in which those acts of use occurred, as well as the **frequency** of those acts, on the other (08/07/2004, [T-334/01](#), Hipoviton, EU:T:2004:223, § 35).

The assessment entails a **degree of interdependence between the factors** taken into account. Thus, the fact that commercial volume achieved under the mark was not high may be offset by the fact that use of the mark was extensive or very regular, and vice versa (08/07/2004, [T-203/02](#), Vitafruit, EU:T:2004:225, § 42).

Under certain circumstances, even **circumstantial evidence** such as catalogues featuring the trade mark, despite not providing direct information on the quantity of goods actually sold, can be sufficient by themselves to prove the extent of use in an overall assessment (15/07/2015, [T-398/13](#) TVR ITALIA (fig.) / TVR et al., EU:T:2015:503, § 57-58; 08/07/2010, [T-30/09](#), Peerstorm, EU:T:2010:298, § 42 et seq.).

Use does not have to be made during a minimum period of time to qualify as 'genuine'. In particular, **use does not have to be continuous** throughout the relevant period of 5 years. It is sufficient if use was made at the very beginning or end of the period, provided the use was genuine (16/12/2008, [T-86/07](#), Deitech, EU:T:2008:577).

The exact **decisive threshold** proving genuine use cannot be defined out of context. The turnover and volume of sales of the product must always be assessed in relation to all the other relevant factors, such as the volume of business, production or marketing capacity, or the degree of diversification of the undertaking using the trade mark, and the characteristics of the products or services on the relevant market. Use need not always be quantitatively significant for it to be deemed genuine, as that depends on the characteristics of the goods or services concerned on the corresponding market (11/03/2003, [C-40/01](#), Minimax, EU:C:2003:145, § 39; 08/07/2004, [T-203/02](#), Vitafruit, EU:T:2004:225, § 42).

Low turnover and sales, in absolute terms, of a medium- or low-priced product might support the conclusion that use of the trade mark in question is not genuine. However, with regard to expensive goods or an exclusive market, low turnover figures or a low volume of sales can be sufficient (22/10/2020, [C-720/18](#) & [C-721/18](#), Testarossa, ECLI:EU:C:2020:854, § 51-52). It is, therefore, always necessary to take the characteristics of the market in question into account (08/07/2004, [T-334/01](#), Hipoviton, EU:T:2004:223, § 51).

A *de minimis* rule cannot be laid down. Use of the mark by a single client, which imports the products for which the mark is registered, can be sufficient to demonstrate that such use is genuine if it appears that the import operation has a genuine commercial justification for the proprietor of the mark (27/01/2004, [C-259/02](#), Laboratoire de la mer, EU:C:2004:50, § 24 et seq.).

Genuine use is not excluded only because all use involves the same customer, as long as the trade mark is used publicly and outwardly and not solely within the undertaking that owns the earlier trade mark or within a distribution network owned or controlled by that undertaking (08/07/2004, [T-203/02](#), Vitafruit, EU:T:2004:225, § 50; 08/10/2014, [T-300/12](#), Fairglobe, EU:T:2014:864, § 36).

The smaller the commercial volume of the exploitation of the mark, the more necessary it is for the opposing party to produce additional evidence to dispel any doubts as to its genuineness (08/07/2004, [T-334/01](#), Hipoviton, EU:T:2004:223, § 37).

Concerning the ratio between the turnover generated by the sales of products under the earlier mark and the applicant's annual turnover, it should be noted that the degree of diversification of the activities of undertakings operating in one and the same market varies. Moreover, the obligation to produce evidence of genuine use of an earlier trade mark is not designed to monitor the commercial strategy of an undertaking. It may be economically and objectively justified for an undertaking to market a product or a range of products even if their share in the annual turnover of the undertaking in question is minimal (08/07/2004, [T-334/01](#), Hipoviton, EU:T:2004:223, § 49).

Special circumstances, for example, lower sales figures during the initial marketing phase of a product, could be of relevance when assessing the genuineness of use

(08/07/2004, [T-334/01](#), Hipoviton, EU:T:2004:223, § 53). The initial phase of marketing a product may last more than a few months but it cannot be prolonged indefinitely (18/03/2015, [T-250/13](#), SMART WATER, EU:T:2015:160, § 54-55; confirmed 17/03/2016, [C-252/15 P](#), SMART WATER, EU:C:2016:178).

## 5.2 Examples of insufficient use

Case No	Comment
18/03/2015, <a href="#">T-250/13</a> , SMART WATER	The test sales of 15 000 water bottles are considered symbolic in the light of the size of the European market (paras 34-35).
16/07/2014, <a href="#">T-196/13</a> , NAMMU, EU:T:2014:1065	The applicant provided an affidavit signed by the Head of the Import Department and Quality Manager, as well as photos, including one of a Nanu-Nana shop front, and others, undated, of various goods, such as folded paper boxes, albums, calendars, stickers, blocks, artists' materials, cards and other paper products, napkins, recipe books, furniture and home decor articles. The goods depicted all bear labels and stickers with the earlier mark on their packaging.  No evidence was submitted to prove the turnover figures given in the affidavits, and the photos were undated (para. 33).
17/01/2013, <a href="#">T-355/09</a> , Walzer Traum, EU:T:2013:22; confirmed 17/07/2014, <a href="#">C-141/13 P</a> , Walzer Traum	The opponent, a German bakery located in a city of 18 000 inhabitants, proved constant monthly sales of approximately 3.6 kg of exclusive, handmade chocolates over a period of 22 months. Despite being advertised on a web page accessible throughout the world, the chocolates could only be ordered and bought in the opponent's bakery. In view of the territorial and quantitative limits, the General Court considered that use had not been sufficiently proven (para. 32 et seq.).

Case No	Comment
30/04/2008, <a href="#">T-131/06</a> , Sonia Sonia Rykiel, EU:T:2008:135	54 units of women's slips and 31 units of petticoats were sold over a period of 13 months, for a total sum of EUR 432. The General Court considered these modest quantities with regard to the relevant market (everyday consumption goods, sold at a very reasonable price) to be insufficient.
27/02/2009, <a href="#">R 249/2008-4</a> , AMAZING ELASTIC PLASTIC II	500 plastic balloon kits given away as 'samples' free of charge cannot constitute genuine use.
20/04/2001, <a href="#">R 378/2000-1</a> , RINASCIMENTO/ RENACIMIENTO	The Board of Appeal confirmed the decision of the Opposition Division that the submission of one bill of lading showing the delivery of 40 packages of sherry is insufficient to prove genuine use.
09/02/2012, <a href="#">R 239/2011-1</a> , GOLF WORLD (fig.9 / GOLF WORLD et al. <a href="#">(B 1 456 443</a> , Golf World)	As the only evidence of use for <i>printed matter</i> , the opponent submitted evidence that proved 14 subscribers for a magazine in Sweden. The OD held that this is insufficient to prove genuine use in Sweden, particularly taking account of the fact that magazines are not high-priced articles.
20/05/2011, <a href="#">R 2132/2010-2</a> , SUSURRO (fig.) / SUSURRO	Nine invoices concerning the sale of wine in 2005, 2006, 2007 and 2008, showing that over a period of 36 months, goods marketed under the earlier mark and worth EUR 4 286.36 were sold, as well as an undated sample of a product label, were not considered sufficient proof of genuine use of a Spanish trade mark registered for <i>alcoholic drinks (except beers)</i> in Class 33. The evidence showed that the sales of wine had been made in a small, very provincial, part of Spain. For a country with over 40 million inhabitants, the amount sold of a relatively cheap wine was found to be too small to create or preserve an outlet for goods (wine) that are consumed in large quantities by the average Spanish consumer.

Case No	Comment
07/07/2011, <a href="#">R 908/2010-2</a> , ALFA-REN / ALPHA D3 et al.	Table of sales figures for ALFACALCIDOL products in Lithuania between 2005 and 2008, indicating products sold by Teva Corp. under the trade mark 'ALPHA D3' (source: IMS health database, Lithuania); an undated copy of packaging for a product 'ALPHA D3' (undated); and a copy of an advertisement for 'ALPHA D3' products sold in Lithuania (not translated) were found insufficient to show genuine use of the mark in Lithuania. It could not be seen from the evidence submitted whether the marked goods were actually distributed and, if so, the quantities involved.
16/03/2011, <a href="#">R 820/2010-1</a> , BE YOU / BEYU	Sales of goods with profits below EUR 200 during the 9-month period of use were not considered sufficient proof of genuine use of the opposing mark in respect of the goods in Class 14.
06/04/2011, <a href="#">R 999/2010-1</a> , TAUTROPFEN CHARISMA (fig.) / CHARISMA	Eleven invoices showing that 13 units of <i>perfumery</i> goods were sold in Spain between 2003 and 2005, for a total amount of EUR 84.63, were deemed as insufficient proof of genuine use of the sign. Account has been taken of the fact that the goods were intended for daily use and available at a very affordable price.
27/10/2008, <a href="#">B 1 118 605</a> , Viña la Rosa	Photocopies of three independent wine guides mentioning the opponent's trade mark (without further explanation as to the volume, edition, publisher, etc.) were not considered sufficient to prove use for wines.
21/06/1999, <a href="#">B 70 716</a> , Oregon	The Opposition Division found an invoice for 180 pairs of shoes as insufficient to prove genuine use.
30/01/2001, <a href="#">B 193 716</a> , Lynx	As evidence of use the opponent submitted two invoices, for a total amount of 122 items of clothing, and four undated labels with no indication of what goods they were to be affixed to. The Opposition Division considered them insufficient.

### 5.3 Examples of sufficient use

Case No	Comment
<p>16/11/2011,  <a href="#">T-308/06</a>,            Buffalo Milke,            EU:T:2011:675</p>	<p>Nine invoices dated between April 2001 and March 2002, representing sales of around EUR 1 600 (with a turnover figure barely above EUR 1 000 000 per year) and showing that items were delivered to different customers in small quantities (12, 24, 36, 48, 60, 72 or 144 pieces), for widely used products like <i>shoe polish</i>, in the largest European market, Germany, with approximately 80 million potential consumers, were deemed as providing evidence of use that objectively is such as to create or preserve an outlet for <i>polishing cream</i> and <i>leather conditioner</i>. Furthermore, the volume of sales, in relation to the period and frequency of use, was deemed to be significant enough not to be considered merely token, minimal or notional for the sole purpose of preserving the rights conferred by the mark. Confirmed by the General Court (para. 68)</p>
<p>10/09/2008,  <a href="#">T-325/06</a>,            Capio,            EU:T:2008:338</p>	<p>Evidence (invoices, lists of sales) proving that the intervener sold 4 hollow-fibre oxygenators with detachable hard-shell reservoirs in Finland in 1998, 105 in 1999 and 12 in 2001, for a total amount of EUR 19 901.76, was deemed sufficient proof of genuine use of the EUTM registered for <i>oxygenators with integrated pump; controllers for integrated pump; regulating devices of air pressure for integrated pump; suction pumps; blood flow meters</i> in Class 10 (paras 48, 60).</p>

Case No	Comment
<p>27/09/2007,  <a href="#">T-418/03</a>,            La Mer,            EU:T:2007:299</p>	<p>Ten invoices over a period of 33 months, relating to several product ranges, the packaging of which bears the trade mark concerned, with numbers very far apart (22 214 for the invoice of 03/01/1995, 24 085 for that of 04/05/1995, 24 135 for that of 10/05/1995 and 31 348 for that of 26/03/1997), showing that the sales were made to different persons, were deemed as permitting the inference that they had been submitted merely by way of illustration of total sales but not as showing that the trade mark was used publicly and outwardly rather than solely within the undertaking that owned the earlier trade mark or within a distribution network owned or controlled by that undertaking. Nevertheless, the sales effected, while not considerable, were deemed as constituting use that objectively was such as to create or preserve an outlet for the products concerned and entailing a volume of sales that, in relation to the period and frequency of use, was not so low as to allow the conclusion that the use was merely token, minimal or notional for the sole purpose of preserving the rights conferred by the mark (paras 87-90).</p>
<p>25/03/2009,  <a href="#">T-191/07</a>,            Budweiser,            EU:T:2009:83</p>	<p>The Board of Appeal (20/03/2007, <a href="#">R 299/2006-2</a>, 'BUDWEISER/BUDWEISER BUDVAR (fig.) et al., § 26) found essentially that the documents presented to it during the administrative proceedings — invoices proving the sale of beer in France amounting to more than 40 000 litres between October 1997 and April 1999, 23 invoices issued in Austria between 1993 and 2000 to a single buyer in Austria, and 14 invoices issued in Germany between 1993 and 1997 — were sufficient to demonstrate the extent of use of the earlier international word mark BUDWEISER (IR No 238 203) in those countries. The Board's findings were confirmed by the General Court.</p>

Case No	Comment
11/05/2006, <a href="#">C-416/04 P</a> , Vitafruit, EU:C:2006:310	Evidence of the sale to a single customer in Spain of concentrated fruit juices during a period of 11.5 months, with a total volume of sales of EUR 4 800, corresponding to the sale of 293 cases of 12 items each, was considered sufficient use of the earlier Spanish trade mark (paras 68-77).
08/07/2010, <a href="#">T-30/09</a> , Peerstorm, EU:T:2010:298	As evidence of use, the opponent (merely) provided several catalogues for end consumers, featuring the relevant trade mark on clothing articles. The Court held that ‘...it is true that those catalogues provide no information on the quantity of goods actually sold by the intervener under the trade mark PETER STORM. However, it is necessary to take into account ... the fact that a large number of items designated by the trade mark PETER STORM were offered in the catalogues and that those items were available in more than 240 shops in the United Kingdom for a significant part of the relevant period. Those factors support the conclusion, in the context of a global assessment ... that the extent of its use was fairly significant’ (paras 42 to 43).
04/09/2007, <a href="#">R 35/2007-2</a> , DINKY	The sale of approximately 1 000 miniature toy vehicles was considered sufficient extent of use in light of the products being sold mainly to collectors at a high price in a particular market.
11/10/2010, <a href="#">R 571/2009-1</a> , VitAmour / VITALARMOR	The sale of 500 kg of milk proteins for a total value of EUR 11 000 was considered sufficient to prove genuine use for <i>milk proteins for human consumption</i> . In view of the nature of the products, which are not consumer goods but ingredients for use by the food processing industry, the amount and values shown did demonstrate a market presence above the threshold required.



Case No	Comment
27/07/2011, <a href="#">R 1123/2010-4</a> , Duracryl / DURATINT et al.	Eleven invoices made out to different undertakings in various regions of Spain, showing that the proprietor of the mark sold, in the relevant period and under the mark, 311 containers of the product, in different sizes, for a net amount of EUR 2 684, were deemed sufficient to prove genuine use of a mark registered for <i>preservatives against deterioration of wood</i> in Class 2.
01/02/2011, <a href="#">B 1 563 066</a>	An annual turnover of more than EUR 10 million over several years was claimed for <i>medical preparations</i> . The corresponding invoices (one per relevant year) only proved actual sales of about EUR 20 per year. In an overall assessment, and in the context of further material submitted, such as price lists, a sworn statement, packaging and advertising material, the Office found this sufficient to prove genuine use.
26/01/2001, <a href="#">B 150 039</a>	The Opposition Division regarded evidence of sales of around 2 000 furry toy animals in a high-priced market sector as sufficient.
18/06/2001, <a href="#">B 167 488</a>	The opponent submitted one invoice referring to the sale of one high-precision laser cutting machine for FRF 565 000, a catalogue describing its performance and some photographs depicting the product. The Opposition Division considered them as sufficient evidence taking into account the nature of the product, the specific market and its considerably high price.

## 6 Nature of use

The term 'nature of use' refers to:

- use of the mark in accordance with its essential function, in the course of trade ([paragraph 6.1](#) below);
- use of the mark as registered or of a variation thereof ([paragraph 6.2](#) below); and
- use of the mark in connection with the goods and services for which it is registered ([paragraph 6.3](#) below).

## 6.1 Use as a trade mark

### 6.1.1 Use of a mark in accordance with its function

#### 6.1.1.1 Use of individual marks

[Article 18](#) and [Article 47\(2\) EUTMR](#) require proof of genuine use in connection with the goods or services for which the trade mark is registered and which the opponent cites as justification for its opposition. Hence, the opponent has to show that the mark has been used as a trade mark on the market.

As a trade mark has, inter alia, the function of operating as a link between the goods and services and the person responsible for their marketing, the proof of use must establish a **clear link between the use of the mark and the relevant goods and services**. As clearly indicated in [Article 10\(4\) EUTMDR](#), it is not necessary for the mark to be affixed to the goods themselves (12/12/2014, [T-105/13](#) TrinkFix, EU:T:2014:1070, § 28-38). A representation of the mark on packaging, catalogues, advertising material or invoices relating to the goods and services in question constitutes direct evidence that the mark has been put to genuine use.

Genuine use requires that use is made as a **trade mark**:

- not for purely illustrative purposes or on purely promotional goods or services,
- in accordance with its essential function, which is to guarantee the identity of the origin of the goods or services for which it is registered (11/03/2003, [C-40/01](#), Minimax, EU:C:2003:145, § 43).

Therefore, by way of example, the following are **not suitable** for supporting genuine use of a **trade mark**.

1. Use as a **certification mark**. Certification marks can be obtained in some jurisdictions for compliance with defined standards. The holder of a certification mark is not the authorised user, producer or provider of the certified goods or services, but rather the certifier, which exercises legitimate control over use of the certification mark. Certification marks may be used together with the individual trade mark of the producer of the certified goods or of the provider of the certified services. The essential function of a certification mark is different from the essential function of an individual trade mark: while the latter primarily serves to identify the origin of goods and services, the former serves to certify that the goods or services meet certain established standards and possess particular characteristics. Therefore, use as a certification mark does not serve as use as an individual trade mark, because it does not guarantee to consumers that the goods or services come from a single undertaking under the control of which the goods or services are manufactured or supplied and which, consequently, is responsible for the quality of those goods or services (08/06/2017, [C-689/15](#), Cotton Flower, EU:C:2017:434, § 45).

2. Use as a **Geographical Indication** (GI). The essential function of GIs is to designate the origin of goods as being from a particular region or locality. This is in contrast with the main function of an individual trade mark, namely to serve as an indicator of commercial origin. When a GI is contained within an individual mark that guarantees to consumers that the goods which it designates come from a single undertaking under the control of which those goods are manufactured and which is responsible for the quality of those goods, the opponent must submit proof of use as an individual mark (07/06/2018, [T-72/17](#), Steirisches Kürbiskernöl (fig.), EU:T:2018:335, § 52; 17/10/2019, [C-514/18 P](#), Steirisches Kürbiskernöl (fig.), EU:C:2019:878, § 37-43). Evidence of use as a GI (e.g. general statements of Regulatory Councils) cannot serve for proving use as an individual mark. For more information on geographical indications see [the Guidelines, Part B, Examination, Section 4, Absolute Grounds for Refusal, Chapter 10, Trade Marks in Conflict with Geographical Indications \(Article 7\(1\)\(j\) EUTMR](#).

Depending on the circumstances, the following situations may be suitable for supporting genuine use of the registered trade mark. That is because use of the sign can serve more than one purpose at the same time. Consequently, the following uses can also be use of the sign as a trade mark. However, the purpose for which a sign is used needs to be assessed individually.

1. **Use of a sign as a business, company or trade name** can be regarded as trade mark use provided that the relevant goods or services themselves are identified and offered on the market under this sign (13/04/2011, [T-209/09](#), Alder Capital, EU:T:2011:169, § 55-56). In general, this is not the case when the business name is merely used as a shop sign (except when proving use for retail services), or appears on the back of a catalogue or as an incidental indication on a label (18/01/2011, [T-382/08](#), Vogue, EU:T:2011:9, § 47).

In principle, use of the sign as a **company name or trade name**, is not, of itself, intended to distinguish goods or services. The purpose of a **company name** is to identify a company, whereas the purpose of a **trade name or a shop name** is to designate a business that is being run. Accordingly, where use of a company name, trade name or shop name is limited to identifying a company or designating a business that is being run, such use cannot be considered as being 'in relation to goods or services' (11/09/2007, [C-17/06](#), Céline, EU:C:2007:497, § 21; 13/05/2009, [T-183/08](#), Jello Schuhpark II, EU:T:2009:156, § 31-32).

Use of a business, company or trade name can be regarded as **use 'in relation to goods'** where:

- a party **affixes the sign** constituting its company name, trade name or shop name to the goods or;
- even though the sign is not affixed, the party uses the sign in such a way that a **link is established** between the company, trade or shop name and the goods or services (11/09/2007, [C-17/06](#), Céline, EU:C:2007:497, § 21-23).

Provided that either of these two conditions is met, the fact that a word element is used as the company's trade name does not preclude its use as a mark to designate goods or services (30/11/2009, [T-353/07](#), Coloris, EU:T:2009:475, § 38).

For example, the presentation of the business name at the top of **order forms or invoices** may, depending on how the sign appears on them, be suitable to support genuine use of the registered trade mark (06/11/2014, [T-463/12](#), MB, EU:T:2014:935, § 44-45). Simultaneous use of the company name and the trade mark on invoices may, when the two indications can be clearly distinguished, prove use of the sign as an indicator of the commercial origin of the services provided, irrespective of the fact that the invoices may also show other sub-brands (03/10/2019, [T-666/18](#), ad pepper (fig.), EU:T:2019:720, § 82-84).

However, mere use of a business name at the top of invoices without a clear reference to specific products/services is not sufficient.

2. Use of a **sign as a domain name or as part of a domain name** primarily identifies the website as such. However, depending on the circumstances, such use may also be use of a registered mark (this presupposes that it connects to a site on which the goods and services appear).

The mere fact that the opponent has registered a domain name containing the earlier trade mark is not sufficient in itself to prove genuine use of the trade mark. It is necessary for the party to prove that the relevant goods or services are offered under the trade mark contained in the domain name.

#### 6.1.1.2 Use of collective and certification marks

National and EU collective marks and certification marks can also constitute 'earlier trade marks' within the meaning of [Article 8\(2\) EUTMR](#) on which an opposition can be based and, as such, be subject to the requirement of use pursuant to [Article 47\(2\) and \(3\) EUTMR](#).

The requirements of the EUTMR relating to the conditions of use apply. However, the different function of these marks must be taken into account. The opponent must demonstrate that the authorised persons (see [paragraph 7.3](#)) used the collective or certification mark in accordance with its essential function.

The essential function of a **collective mark** is to distinguish the goods or services of the members of the **association** that is the proprietor of the mark from those of other undertakings (20/09/2017, [C-673/15 P & C-674/15 P & C-675/15 P & C-676/15 P](#), DARJEELING (fig.) / DARJEELING et al., EU:C:2017:702, § 63). The specific characteristic of collective marks is to indicate the **collective** commercial origin of the goods or services, that is to say to indicate that certain products or services come from a member of a certain 'collective', which is the proprietor of the collective mark, and not an **individual** commercial origin as is the case with individual marks. Therefore, unlike an individual mark, a collective mark does not have the function of indicating to consumers 'the identity of origin' of the goods or services in respect of which it is registered. Manufacturers, producers, suppliers or traders who are affiliated with the

association that is the proprietor of a collective mark do not have to form part of the same group of companies that manufacture or supply the goods or services under unitary control. In fact, they can be competitors, each of which uses, on the one hand, the collective mark indicating their affiliation with that association and, on the other, an individual mark indicating the identity of origin of their goods or services. However, like an individual mark, a collective mark must be used by the members of the association to create or preserve an outlet for the registered goods or services (12/12/2019, [C-143/19 P](#), EIN KREIS MIT ZWEI PFEILEN (fig.), EU:C:2019:1076).

The essential function of a **certification mark** is not to indicate **commercial** origin, as for individual and collective marks, but to differentiate the goods and services that are certified by the proprietor of the mark as meeting established standards and possessing particular characteristics from those that are not thus certified. For the use of a certification mark to be considered genuine, it must be used in accordance with this essential function.

## 6.1.2 Use in the course of trade

### 6.1.2.1 Public use versus internal use

The use must be public, that is to say it must be external and apparent to actual or potential customers of the goods or services. Use in the private sphere or purely internal use within a company or a group of companies does not amount to genuine use (09/12/2008, [C-442/07](#), Radetzky, EU:C:2008:696, § 22; 11/03/2003, [C-40/01](#), Minimax, EU:C:2003:145, § 37; 09/09/2015, [T-584/14](#), ZARA, EU:T:2015:604, § 33).

The mark must be used **publicly and outwardly** in the context of commercial activity with a view to economic advantage for the purpose of ensuring an outlet for the goods and services that it represents (12/03/2003, [T-174/01](#), Silk Cocoon, EU:T:2003:68, § 39; 30/04/2008, [T-131/06](#), Sonia Sonia Rykiel, EU:T:2008:135, § 38). Outward use does not necessarily imply use aimed at end consumers. For instance, the relevant evidence can validly stem from an **intermediary**, whose activity consists of identifying professional purchasers, such as distribution companies, to which the intermediary sells products it has had manufactured by original producers (21/11/2013, [T-524/12](#), RECARO, EU:T:2013:604, § 25-26).

Relevant evidence can also validly come from a **distribution company** that forms part of a group. Distribution is a method of business organisation that is common in the course of trade and implies use of the mark that cannot be regarded as purely internal use by a group of companies, since the mark is also used outwardly and publicly (17/02/2011, [T-324/09](#), Friboi, EU:T:2011:47, § 32).

Use of the mark must **relate to goods or services** already marketed or about to be marketed and for which preparations by the undertaking to secure customers are under way. Mere preparation to use the mark — such as the printing of labels, producing of containers, etc. — is internal use and, therefore, not use in the course of trade for the present purposes (11/03/2003, [C-40/01](#), Minimax, EU:C:2003:145, § 37).

## 6.1.2.2 Commercial activity versus promotional activity

Where the mark is protected for goods or services of **not-for-profit enterprises**, and the mark has been used, the fact that there is no profit motive behind the use is irrelevant: 'The fact that a charitable association does not seek to make profit does not mean that its objective cannot be to create and, later, to preserve an outlet for its goods or services' (09/12/2008, [C-442/07](#), Radetzky, EU:C:2008:696, § 17).

Goods and services offered **free of charge** may constitute genuine use when they are offered commercially, that is to say with the intention of creating or maintaining an outlet for those goods or services in the EU, as opposed to the goods or services of other undertakings, and therefore of competing with them (09/09/2011, [T-289/09](#), Omnicare Clinical Research, EU:T:2011:452, § 67-68).

Mere use of the mark on **promotional material for other goods** cannot normally be considered as sufficient (indirect) evidence of use within the meaning of trade mark law for the type of promotional items on which the mark is or has been used. For example, giving away articles of clothing such as T-shirts and baseball caps at promotional events with the purpose of marketing a certain other product, such as a drink, cannot be considered as genuine use of the mark at issue for clothing.

The Office practice concerning 'genuine use' with regard to promotional articles has been confirmed by the Court.

Earlier sign	Case No
WELLNESS	15/01/2009, <a href="#">C-495/07</a> , EU:C:2009:10 (preliminary ruling)
<p>The opponent owned the mark 'WELLNESS' in Classes 25 and 32. In the context of selling its 'WELLNESS' clothing, it also used the mark to designate an alcohol-free drink, which was handed out in small bottles as a gift along with the clothing sold. No drinks were sold separately under the 'WELLNESS' mark.</p> <p>The Court held that, where promotional items are handed out as a reward for the purchase of other goods and to encourage the sale of the latter, the mark loses its commercial raison d'être for the promotional goods and cannot be considered to have been genuinely used on the market for goods in that class (para. 22).</p>	

## 6.1.2.3 Use in relation to goods

Trade marks have traditionally been used on goods (printed on the goods, on labels, etc.) or their packaging. However, showing use on goods or their packaging is not the only way of proving use in relation to goods. It is sufficient, if there is a proper connection between the mark and the goods, for the mark to be used 'in relation to' the

goods or services, such as on brochures, flyers, stickers, signs inside places of sale, etc.

For example, when the opponent sells its goods only through catalogues (mail-order sales) or the internet, the mark may not always appear on the packaging or even on the goods themselves. In such cases, use on the (internet) pages where the goods are presented — provided it is otherwise genuine in terms of time, place, extent and nature — will generally be considered sufficient. The owner of the mark will not have to provide proof that the mark actually appeared on the goods themselves.

Earlier sign	Case No
PETER STORM	08/07/2010, <a href="#">T-30/09</a> , Peerstorm, EU:T:2010:298
The evidence produced to show genuine use of the mark at issue may include catalogues. 'It must be pointed out that, in addition to items of clothing designated by different marks, more than 80 different items are offered for sale in that catalogue under the mark PETER STORM. They comprise men's and women's jackets, jumpers, trousers, tee-shirts, footwear, socks, hats and gloves, the respective characteristics of which are briefly described. The earlier mark appears, in stylised characters, next to each item. In that catalogue, the prices of the items in GBP and the reference number for each item are stated' (paras 38-39).	

However, the situation is different when a trade mark is used, for example, in a catalogue or advertisements, or on bags or invoices, to designate the retailer of the goods and not the goods themselves.

Earlier sign	Case No
Schuhpark	13/05/2009, <a href="#">T-183/08</a> , Jello Schuhpark II, EU:T:2009:156
The General Court found that the use of the sign <i>Schuhpark</i> for footwear on advertisements, bags and invoices was not meant to identify the origin of the shoes (which bore their own mark or no mark at all) but rather the <b>company name or trade name</b> of the shoe retailer. This was considered insufficient to establish a link between the sign <i>Schuhpark</i> and the shoes. In other words, <i>Schuhpark</i> may well be a mark for the retail of shoes, but it was not used as a trade mark for goods (paras 31-32).	

#### 6.1.2.4 Use in relation to services

Marks cannot be directly used 'on' services. Therefore, use of marks registered for services will generally be on business paper, in advertising, or in some other way directly or indirectly related to the services. Where the use on such items demonstrates genuine use, such use will be sufficient.



Earlier sign	Case No
	06/11/2014, <a href="#">T-463/12</a> , MB, EU:T:2014:935
The earlier trade mark was registered in Class 42 for, inter alia, the services of a patent attorney. Its use on invoices, business cards and business correspondence was considered sufficient to show genuine use in connection with the services of a patent attorney.	
STRATEGIES	05/10/2010, <a href="#">T-92/09</a> , STRATEGI / Stratégies, EU:T:2010:424
Where an earlier mark was registered for <i>business management</i> services and used as the title of business magazines, the General Court did not exclude that such use could be considered genuine for the services in question if it were shown that the magazine provides support for the supply of the <i>business management</i> services, i.e. if the services are provided through the medium of a magazine. The fact that there is no 'direct bilateral link' between the publisher and the recipient of the services does not impair such a finding of genuine use. This is because the magazine is not distributed free of charge, which could lend credibility to the claim that payment of the price of the magazine constitutes remuneration for the service provided (paras 31-35).	

#### 6.1.2.5 Use in advertising

Trade marks fulfil their function of indicating the commercial origin of goods or services and symbols of the goodwill of their owner not only when they are actually used on or for goods or services, but also when they are used in advertising. In fact, the advertising or market communication function of trade marks is one of their most important functions.

Therefore, use in advertising will generally be considered as amounting to genuine use:

- if the volume of advertising is sufficient to constitute genuine public use of the mark; and
- if a relation can be established between the mark and the goods or services for which the mark is registered.

The Court confirmed this approach in the *Minimax* case, where it held that use of the mark must relate to goods or services already marketed or about to be marketed and for which preparations by the undertaking to secure customers are under way, **particularly in the form of advertising campaigns** (11/03/2003, [C-40/01](#), *Minimax*, EU:C:2003:145, § 37).

However, the outcome in a particular case will depend very much on the individual circumstances, as demonstrated by the following examples:



Earlier sign	Case No
BLUME	28/10/2002, <a href="#">R 681/2001-1</a> , Blumen Worldwide (fig.) / BLUME, LEOPOLDO BLUME
<p>Services: services of a publishing company in Class 41.</p> <p>The Board confirmed that the evidence (consisting of catalogues, press notes and advertisements) read in conjunction was enough to prove genuine use of the trade mark.</p> <p>'Although the order record and the receipt of the bank account do not provide any information on how and to what extent the mark was used in Spain, the remaining documents, namely the catalogues, press notes and advertisements, when read in conjunction, demonstrate that during the relevant period, the opponent has published in Spain books and magazines under the trade mark BLUME. Even if the opponent does not provide any invoices, orders or sales figures, there is some reason to assume that it advertised its books and magazines, promoted and sold them under the trade mark BLUME. Although the advertising documents and the press notes were identified and dated by the opponent, the trade mark BLUME is always mentioned in the press notes and on the cover page of the quoted books. In addition, the text is in the Spanish language and the price mentioned in pesetas. When read together with the catalogues, these press notes demonstrate that they refer to some of the books expressly quoted in the catalogues' (para. 23).</p>	

Earlier sign	Case No
BIODANZA	13/04/2010, <a href="#">R 1149/2009-2</a> , BIODANZA (fig.) / BIODANZA; confirmed 08/03/2012, <a href="#">T-298/10</a> , Biodanza, EU:T:2012:113

G&S: Classes 16 and 41.

The Board rejected the Opposition Division’s finding that the evidence (only advertisements) proved genuine use.

It follows clearly from the finding of the contested decision that the evidence of use submitted by the opponent consists solely of advertisements that can prove only that the opponent advertised a yearly ‘BIODANZA’ festival during the whole of the relevant period and workshops on both a regular and irregular basis from 2002.

However, contrary to the finding of the contested decision, such advertisements cannot provide proof of their distribution to a potential German clientele. Nor can they prove the extent of any distribution or the number of sales or contracts made for the services protected by the mark. The mere existence of advertisements could, at most, make it probable or credible that the services advertised under the earlier mark were sold or, at least, offered for sale within the relevant territory, but it cannot prove this, as was unduly supposed by the contested decision.

Where advertising is carried out in parallel with the marketing of goods and services and there is proof of both activities, advertising will support the genuineness of the use.

Advertising in advance of the actual marketing of goods and services — if it is with a view to establishing a market for the goods or services — will generally be considered to constitute genuine use.

Whether mere advertising, without any current or future plans to actually market goods or services, constitutes genuine use appears doubtful. As in most other situations, the outcome will depend on the circumstances of each case. For example, where the goods or services are available abroad, such as holiday accommodation or particular products, advertising alone may be sufficient to amount to genuine use.

6.1.2.6 Use on the internet

The standard applied when assessing evidence in the form of printouts from the internet is no stricter than when evaluating other forms of evidence. Consequently, the presence of the trade mark on websites can show inter alia the nature of its use or the fact that products or services bearing the mark have been offered to the public. However, the mere presence of a trade mark on a website is, of itself, not sufficient to prove genuine use unless the website also shows the place, time and extent of use or unless this information is otherwise provided.

Earlier sign	Case No
SHARP	20/12/2011, <a href="#">R 1809/2010-4</a> , SHARPMaster / SHARP (fig.)

Earlier sign	Case No
<p>The opponent submitted 'extracts from the opponent's websites for different countries'. The Board considered that 'simple print-outs from a company's own Internet page is not able to prove use of a mark for certain goods without complementary information as to the actual use of the Internet site by potential and relevant consumers or complementary advertising and sales figures regarding the different goods, photos of the goods with the corresponding mark etc.' (para. 33).</p>	

Earlier sign	Case No
<p>WALZERTRAUM</p>	<p>17/01/2013, <a href="#">T-355/09</a>, Walzer Traum, EU:T:2013:22; confirmed 17/07/2014, <a href="#">C-141/13 P</a>, Walzer Traum, EU:C:2014:2089</p>
<p>The opponent, a confectioner, which owns the German trade mark 'WALZERTRAUM' for goods in Class 30, sought to prove the extent of use of its mark by submitting evidence relating to an advertising brochure published on the internet, which gives general information about its working methods, the ingredients used for its products and the product range, including its 'WALZERTRAUM' chocolate. However, the goods could not be ordered online via the web page. For this reason the General Court held that a connection between the website and the number of items sold could not be established (para. 47).</p>	

In particular, the value in terms of evidence of internet extracts can be strengthened by submitting evidence that the specific website has been visited and, in particular, that orders for the relevant goods and services have been made through the website by a certain number of customers in the relevant period. For instance, useful evidence in this regard could be records that are generally kept when operating a business web page, for example records relating to the number of hits attained at various points in time or, in some cases, the countries from which the web page has been accessed.

As to the **relevant period**, information on the internet or in online databases is considered to be of the date on which the information was posted. Internet websites often contain highly relevant information. Certain information may even be available only from such websites. This includes, for example, online catalogues that are not available in printed format.

The nature of the internet can make it difficult to establish the actual date on which information was in fact made available to the public. For instance, not all web pages mention when they were published. In addition, websites are easily updated, yet most do not provide any archive of previously displayed material, nor do they display records that enable members of the public to establish precisely what was published when.

In this context, the date of use on the internet will be considered reliable in particular where:

- the website time-stamps each entry and thus provides information relating to the history of modifications applied to a file or web page (for example, as available for Wikipedia or as automatically appended to content, e.g. forum messages and blogs); or
- indexing dates are given to the web page by search engines (e.g. from the Google™ cache); or
- a screenshot of a web page bears a given date.

The evidence submitted must show that the online transactions were **connected with the goods or services** designated by the mark.

Earlier sign	Case No
ANTAX	02/02/2012, <a href="#">T-387/10</a> , Arantax, EU:T:2012:51
The opponent has submitted, inter alia, internet extracts from the home pages of several tax consultancies using the opposing mark. The General Court considered that the indications on the internet pages allowed the reader to establish a link between the trade mark and the services provided (paras 39-40).	

Whereas the **nature of the mark** and, to a certain extent, the **time** (as seen above) and **place** are less complex elements to prove, the **extent of use** presents more difficulties if only evidence of internet use is provided. It should be taken into account that transactions on the internet tend to eliminate most of the ‘traditional’ evidence of sales such as invoices, turnover, taxation documents, etc. New ‘electronic’ evidence tends to substitute them, or has already substituted them, as certified means of payment, orders and confirmations thereof, registrations of safe transactions, etc.

Earlier sign	Case No
Skunk funk (fig.)	31/03/2011, <a href="#">R 1464/2010-2</a> , SKUNK FU! (fig.) / SKUNK FUNK (fig.)
‘[E]xcerpts from third parties’ websites, despite having been printed out on 10 June 2008, contain consumers’ comments about ‘SKUNKFUNK’ clothes and shops dated within the relevant period. In particular, as regards the relevant territory, the documents show various comments made by consumers in Spain and dated December 2004 and February-March-April-May-July 2007. Moreover, as the Opposition Division pointed out, a blog comment (dated 4 March 2007) on the Internet page <a href="http://www.cybereuskadi.com">www.cybereuskadi.com</a> mentions that the opponent (‘designer of Skunkfunk’) “exports surf clothes worldwide and has a turnover of nearly 7 million euros per year” (para. 21).	

For further information regarding evidence originating from the Internet, please see the Guidelines, [Part C, Opposition, Section 5, Trade Marks with Reputation \(Article 8\(5\) EUTMR\), paragraph 3.1.4.4.](#)

## 6.2 Use of the mark as registered or of a variation thereof

When assessing genuine use of a trade mark, it must be taken into account that trade marks are used in a commercial context, on products, packaging, information and advertising materials, etc. They are normally used together with other product information, marketing messages, decorative elements and often with other marks (individual, collective or certification marks) or geographical indications and related symbols. Therefore, verifying whether the mark was used 'as registered' may prove to be a challenging exercise.

This section deals with (i) simultaneous use of independent marks and (ii) use in a different form that does not alter the distinctiveness of the mark as registered.

[Article 18\(1\)\(a\) EUTMR](#) provides that, apart from use of the mark in its registered form, use of the trade mark in a form differing in elements that do not alter the distinctive character of the mark as registered also constitutes 'use of the trade mark'. This applies regardless of whether the mark as used is also the subject of a separate trade mark registration of the proprietor.

The purpose of this provision is to allow the proprietor, in the commercial exploitation of the mark, to make variations in the mark that, without altering its distinctive character, enable it to be better adapted to the marketing and promotion requirements of the goods or services concerned (23/02/2006, [T-194/03](#), Bainbridge, EU:T:2006:65, § 50). In accordance with the purpose of that provision, where the mark used in trade differs from the form in which it was registered, the difference must be such that the two can still be regarded as broadly equivalent.

Endeavouring to converge trade mark practices, the European Union Intellectual Property Network published a Common Communication on the Common Practice - the Use of a Trade Mark in a Form Differing from the One Registered ([CP8](#))<sup>(83)</sup>. This section of the Guidelines is in line with CP8.

### 6.2.1 Use in the form as registered – simultaneous use of independent marks

Trade marks are often used together with other marks, for example, to indicate a house mark and a sub-brand. This constitutes use of a mark in the **same form** as registered, in parallel with, but independently from, other marks (simultaneous use of independent marks). This is different from use of a mark in a **different form** than the one registered (08/12/2005, [T-29/04](#), Cristal Castellblanch, EU:T:2005:438, § 33, 34; 06/11/2014, [T-463/12](#), MB, EU:T:2014:935, § 43). Consequently, in the case of simultaneous use of independent marks, the question of whether the distinctive character of the mark as registered has been altered does not even arise and [Article 18\(1\)\(a\) EUTMR](#) is not applicable. Accordingly, use of a mark without any modification, including simultaneous

<sup>83</sup> Available at <https://www.tmdn.org/network/converging-practices>

use with separate, independent marks, is covered by the first subparagraph of [Article 18\(1\) EUTMR](#), not by [Article 18\(1\)\(a\) EUTMR](#).

To establish simultaneous use, what has to be determined is whether the marks in question, despite being used together, remain **independent** from each other and whether they will be perceived in this way by the public. This is in contrast to where the public will instead perceive them as forming a **unit** and not as 'separate, independent marks'. In principle, a visual and/or conceptual **interaction** between the components that results in an inseparable unit would preclude those components from being perceived as 'separate, independent marks'. This requires a global assessment of various factors, such as:

- the intrinsic characteristics of the marks (dominant and distinctive elements; their respective position; use in a different size, typeface or colour; presence or absence of syntactical, grammatical or conceptual connections, etc.);
- the way the marks are presented in the evidence of use and the context of use (the business practices in the trade sector concerned, nature of the marks, i.e. company names, house marks, product-line identifiers, sub-brands etc.);
- specific evidence capable of establishing that the marks are perceived independently by the consumers.

A lack of evidence of the independent use and perception of the mark as registered does not preclude assessing the question of simultaneous use on the basis of the intrinsic characteristics of the marks and the general experience of trade practices in the relevant trade sector.



Mark as registered	Mark as used	Case No
YGAY		21/09/2010, <a href="#">T-546/08</a> , i Gai, EU:T:2010:404

The indication 'Marqués de Murrieta' refers to the winery responsible for the production and marketing of the wine, whereas 'YGAY' identifies the particular wine among the range of wines marketed by the manufacturer. The joint use of the words 'Marqués de Murrieta' and the earlier mark on the same medium does not affect the identification function of the earlier mark for the goods at issue. The joint use of several marks on product labels, particularly, those referring to the winery and the particular product, is a common commercial practice in the wine sector (paras 19-25).

Mark as registered	Mark as used	Case No
--------------------	--------------	---------

		<p>13/09/2016, <a href="#">T-146/15</a>, DARSTELLUNG EINES VIELECKS (fig.), EU:T:2016:469</p>
---	---	---

The joint use of a figurative element and a word element on the same textile or clothing item does not undermine the identification function of the registered mark; it is not unusual in the clothing sector to juxtapose a figurative element with a word element referring to the designer or manufacturer, without the figurative element losing its autonomous identification function in the overall impression (paras 58-60).

Mark as registered	Mark as used	Case No
		<p>Invented example (<a href="#">CP8</a>)</p>



Relevant goods are *pharmaceuticals* in Class 5.

The mark as registered, MAPALVAM, is used together with another distinctive mark, that is to say, house mark. In the pharmaceutical sector it is common that the product name appears together with the house mark. The mark as registered will be perceived independently in the mark as used.

Where a **distinctive word is superimposed** over the mark as registered consisting of a figurative element, pattern or a shape **of a low distinctive character**, it may prove difficult to determine whether it is a case of simultaneous use or of an alteration to the earlier mark. The question to be asked is whether the original mark is still perceived independently despite the superimposition of the distinctive word. If it is, it will be treated as simultaneous use. As stated in the judgment of 18/04/2013, [C-12/12](#), Colloseum Holding, EU:C:2013:253, § 35, a registered trade mark that is used only as part of a composite mark or in conjunction with another mark must **continue to be perceived as indicative of the origin of the product** at issue for that use to be covered by the term 'genuine use' within the meaning of Article 15(1) of Regulation No 40/94. <sup>(84)</sup> On the other hand, if it cannot be established that the original figurative, shape, pattern mark is perceived as an independent mark, this is not a scenario of

‘simultaneous use’ and the case must be assessed under the rules of alteration of distinctive character (see paragraph 6.2.2.1.2).

Conversely, where the mark as registered is a figurative or shape mark that is **not of a low distinctive character**, the superimposition of a distinctive word will normally not affect the capability of that figurative or shape mark to be perceived as an independent mark, as in the following examples of simultaneous use.



Mark as registered	Mark as used	Case No
		<p>10/10/2017, <a href="#">T-211/14 RENV.</a>, SHAPE OF AN OVEN (3D), EU:T:2017:715</p> <p>appeal dismissed, 23/01/2019, <a href="#">C-698/17 P</a>, SHAPE OF AN OVEN (3D), EU:C:2019:48</p>

First, it must be noted that, the mark as registered diverges significantly from what is customary in the relevant sector with regard to both, its cylindrical shape and the mode of operation induced by that shape. In those circumstances, that mark was considered to have a high degree of distinctive character (paras 42 and 46). Second, the word ‘Bullerjan’ occupies a small part of the structure and is only visible when the structure is viewed from the front part of the combustion chamber. Finally, the panel on which the word mark is embossed is metallic in appearance like the whole structure so that it does not really stand out from the rest of the structure. That word mark is therefore less striking than the shape of the product itself. In those circumstances, the overall perception of the mark in question is not affected by the presence of the word mark ‘Bullerjan’. This is all the more notable since the combination between a three-dimensional form and an additional word mark is common in the sector in question. Consequently, and given the distinctiveness of the mark at issue, that word mark does not call into question the fact that the three-dimensional shape is sufficient, in itself, to determine the commercial origin of those products (para. 47).

Mark as registered	Mark as used	Case No
--------------------	--------------	---------

<sup>84</sup> Article 15(1) of Regulation No 40/94 corresponded to [Article 18\(1\) EUTMR](#), first subparagraph, and not [Article 18\(1\)\(a\) EUTMR](#). The provision corresponding to [Article 18\(1\)\(a\) EUTMR](#) was Article 15(2)(a) in Regulation No 40/94.



		<p>28/02/2019, <a href="#">T-459/18</a>, PEPERO original (fig.) / REPRÉSENTATION D'UN BATÔNNET (fig.), EU:T:2019:119</p>
<p>On the basis of the evidence filed it was concluded that the mark as registered was used as a trade mark, namely, identifying the commercial origin of the goods at issue (paras 76, 94, 98). The superimposition of the mark 'MIKADO' does not alter the distinctive character of the shape mark as registered. In that regard, it should be noted that the mark 'MIKADO' partially covers the three-dimensional shape constituting the earlier mark both on the edge and the front of the packaging. However, the addition of this word will in no way prevent the consumer from perceiving the shape and colours of the earlier mark, the two ends of which remain visible and the relationship between the colours yellow and brown is clearly identifiable. In those circumstances, the 'MIKADO' mark appears as an independent element and not as forming a unit with the earlier mark (paras 99-100).</p>		

### 6.2.2 Use in a form different from the one registered

Where simultaneous use of independent marks is excluded, the difference in the mark as used must be assessed under [Article 18\(1\)\(a\) EUTMR](#) to determine whether it alters the distinctive character of the mark as registered. Essentially, what will be assessed is whether the mark as used constitutes an **acceptable or unacceptable 'variation'** of its registered form.

That assessment consists of two steps.

The **first step** is to clarify what is to be regarded as the distinctive character of the mark as registered by establishing **which elements contribute to the distinctive character** and to **what extent they do so** ('the distinctive essence of the mark'). This requires an assessment of the distinctive and visually dominant character **of the elements of the mark as registered** based on the intrinsic qualities of each, their relative position within the arrangement of the mark and their interactions.

The **second step** is to **identify the differences in the mark as used** and **evaluate the impact of the variations**. It should be established whether that distinctive essence of the mark as registered is present, missing or modified in the mark as used. This requires an assessment of the distinctive and dominant character **of the added, omitted or modified components in the mark as used**, based on the intrinsic qualities of each, their relative position within the arrangement of the mark and their interactions. There is interdependence between the strength of the distinctive character of a mark and the effect of any variation. Marks of a greater distinctive character may be less influenced by variations than marks of a limited distinctive character. Added or omitted elements are more likely to affect the distinctive character of marks of limited distinctive character (10/10/2018, [T-24/17](#), D-TACK / TACK et al., EU:T:2018:668, § 47

and the case-law cited therein). The practices of the relevant trade sector and the perception of the relevant public must also be taken into account.

The following paragraphs contain guidance and examples illustrating the impact of **additions** ([paragraph 6.2.2.1](#)), **omissions** ([paragraph 6.2.2.2](#)) and **modifications of other characteristics**, such as position or proportions ([paragraph 6.2.2.3](#)), depending on whether the mark as registered is of an **average** or a **low** degree of distinctive character. Although the mark as used may contain a **combination** of these variations, including an omission of an element and addition of another (replacement), the principles below may also serve as guidance for such cases.

#### 6.2.2.1 Additions

##### 6.2.2.1.1 Mark as registered distinctive to an average degree

The following main scenarios can be distinguished.

- Addition of a non-distinctive or weakly distinctive element
- Addition of a symbol or other orthographic character
- Addition of a distinctive (interacting) element

##### *Addition of a non-distinctive or weakly distinctive element*

In general, the addition of a non-distinctive or weakly distinctive element (be it a word or figurative element, including stylisation or colour) does not alter the distinctive character of the mark as registered, regardless of whether these elements are visually dominant or not.



Examples where the distinctive character is not altered:

Mark as registered	Mark as used	Case No
AINHOA	(i) AINHOA BIO (ii) AINHOA DELUXE (iii) 	23/09/2015, <a href="#">T-426/13</a> , AINHOA, EU:T:2015:669  appeal dismissed, 16/06/2016, <a href="#">C-611/15</a> P, AINHOA, EU:C:2016:463

G&S: Class 3

Territory: EU

*Assessment:* The additional elements, such as 'bio' or 'deluxe', are descriptive of the characteristics of the goods. The rectangle representing a cloudy sky positioned above the word element does not change the overall impression of the mark (paras 30-32) – acceptable variation.

Mark as registered	Mark as used	Case No
	(i)  (ii) 	29/04/2020, <a href="#">T-78/19</a> , green cycles (fig.), EU:T:2020:166

G&S: Classes 17, 20, 40 and 42

Territory: EU





*Assessment:* The additional elements 'solutions and products', 'plásticos Hidrosolubles s.l.', sometimes also preceded by the preposition 'by', are only minor additions as opposed to the expression 'green cycles', which constitutes the dominant element of the mark as used. The inversion of the colours of the mark as registered is not sufficient to affect the distinctive character of the mark as registered. The colours, blue, green and grey, are not particularly original or unusual in the registered and used forms of the mark (paras 68-69) – acceptable variation.

Mark as registered	Mark as used	Case No
		12/05/2016, <a href="#">T-322/14</a> and <a href="#">T-325/14</a> , MOBILE.DE, EU:T:2016:297 appeal dismissed, 28/02/2018, <a href="#">C-418/16P</a> , mobile.de, EU:C:2018:128

G&S: Class 35

*Territory:* Bulgaria

*Assessment:* Affixing of the element ‘.bg’ to the end of the mark does not alter the distinctive character of the mark as registered. Although this element conveys an additional message, the fact remains that it is commonly perceived as an indication of the top-level domain name associated with Bulgaria. This very common short territorial reference does not have any particular distinctive character. The marks at issue have their dominant word element in common, they also share the characteristics of their graphic configuration, such as the font and the framing, and they differ in secondary elements that are brief and not decisive as to their distinctive character (paras 57-58) – acceptable variation.

Mark as registered	Mark as used	Case No
	<p>(i)  </p> <p>(ii)  </p> <p>(iii)  </p>	<p>15/10/2019, <a href="#">T-582/18</a>, X BOXER BARCELONA (fig.) / X (fig.) et al., EU:T:2019:747</p>

G&S: Class 25





*Territory:* EU (evidence of use focusing on Germany, France and Italy)

*Assessment:* The word elements ‘bionic’, ‘socks’ and ‘technology’ occupy a secondary position in the marks as used because they are placed after the figurative element composed of the letter ‘x’ and the two arrows, which, taking into account its position and size, will attract more of the attention of the relevant public. Furthermore, the elements ‘bionic’, ‘socks’ and ‘technology’ are laudatory with regard to the products designated by the mark or descriptive of some of their characteristics. In particular, the term ‘socks’ is descriptive of the type of products concerned. The term ‘bionic’ will be perceived as a laudatory term, designating the fact of having powerful or exceptional capabilities, especially when used to denote sportswear. The term ‘technology’ will be seen as a reference to ‘smart’ sportswear with special features obtained through the use of technology that allow these garments to adapt to the ambient temperature or humidity (paras 45-48) – acceptable variation.

Mark as registered	Mark as used	Case No
--------------------	--------------	---------

FLAMINAIRE	<b>FLAMINAIRE</b>	08/12/2015, <a href="#">T-583/14</a> , FLAMINAIRE / FLAMINAIRE, EU:T:2015:943
<p>G&amp;S: Classes 16 and 34</p> <p><i>Territory:</i> Spain</p> <p><i>Assessment:</i> The marks as registered and used differ only in the stylisation of the upper-case letter 'A' and the use of a bold font. These differences do not alter the distinctive character of the mark as registered (para. 37) – acceptable variation.</p>		

Mark as registered	Mark as used	Case No
BROWNIES		30/01/2020, <a href="#">T-598/18</a> , BROWNIE / BROWNIE, Brownie (series mark), EU:T:2020:22
<p>G&amp;S: Classes 6, 18, 25, 26, 28 and 41</p> <p><i>Territory:</i> United Kingdom</p> <p><i>Assessment:</i> The word 'brownies' is clearly legible in the form in which the mark was used. The figurative elements of the mark used do not play any significant role in the overall impression conveyed by the mark and have no inherent semantic content of their own which would lend the mark distinctive character or designate the goods concerned. Those figurative elements are limited to the presentation of the word 'brownies' in a yellow stylised font and the dot on the letter 'i' in the form of a flower and, sometimes, an uneven border (paras 65-67) – acceptable variation.</p>		

Mark as registered	Mark as used	Case No
	<p>(i) </p> <p>(ii) </p> <p>(iii) </p>	24/05/2012, <a href="#">T-152/11</a> , Mad, EU:T:2012:263

G&S: Class 25

*Territory:* EU

*Assessment:* The letters M, A, D are arranged in a particular way in the mark as registered. The use of different colour combinations in the forms in which the mark was used should be allowed, as long as the letters contrast against the background (paras 41 and 45) – acceptable variation.

### *Addition of a symbol or other orthographic character*

Adding a punctuation mark (such as a dot or an exclamation mark), another orthographic character (such as an apostrophe, accent, hyphen or space) or other symbols (such as the plural or possessive symbol or the abbreviated company form), does not normally alter the distinctive character of the mark as registered.

However, if the new element changes the perception of the mark, for example by changing the meaning of the mark as registered, a different conclusion may be justified.

Examples where the distinctive character is not altered:

Mark as registered	Mark as used	Case No
CODICE	CÓDICE	16/12/2019, <a href="#">R 2539/2018-2</a> , Codicci banda nera / SHAPE OF A BLACK BOTTLE WITH AN ORANGE LABEL (3D) et al.
<p>G&amp;S: Class 33</p> <p><i>Territory:</i> Spain</p> <p><i>Assessment:</i> The use of the accent does not alter the distinctive character of the mark as registered (para. 28) – acceptable variation.</p>		

Mark as registered	Mark as used	Case No
Tentation	Tentations	29/07/2008, <a href="#">R 1939/2007-1</a> , TEMPTATION FOR MEN YANBAL (fig.) / TENTATION

G&S: Class 3

*Territory:* Benelux, Germany, Italy, Portugal, Romania and Spain (evidence of use focusing on Spain)

*Assessment:* Merely adding the letter 's' to the end of the trade mark does not substantially alter the visual appearance or pronunciation of the registered trade mark and does not create a different conceptual impression on the Spanish market, where the evidence of use focused. The trade mark in question will be perceived merely as being in its plural form as opposed to its singular form (para. 17) – acceptable variation.

Mark as registered	Mark as used	Case No
FOAMASTER	FOAMASTER®	04/07/2019, <a href="#">R 1808/2018-5</a> , Easy foam master / Foamaster et al.
<p>G&amp;S: Class 1</p> <p><i>Territory:</i> Germany</p> <p><i>Assessment:</i> The use of the mark together with the registered trade mark symbol ® does not alter the distinctive character of the mark as registered (paras 52-53) – acceptable variation.</p>		

Example where the distinctive character is altered:

Mark as registered	Mark as used	Case No
MEXAVIT	MEXA-VIT C	30/03/2007, <a href="#">R 159/2005-4</a> , Metavit / MEXA-VIT C et al.
<p>G&amp;S: Class 5</p> <p><i>Territory:</i> Austria</p> <p><i>Assessment:</i> The use of the mark with a different spelling and the addition of the letter 'C' alter the distinctive character of the mark as registered. This is because the letters 'VIT' are now seen as a descriptive element, 'VIT C', which refers to 'Vitamin C' – unacceptable variation.</p>		

#### *Addition of a distinctive (interacting) element*

In principle, the addition of a distinctive element that **interacts** with the mark as registered in such a manner that it can no longer be perceived independently, but rather as **forming a unit** (thus excluding simultaneous use of several marks) alters the distinctive character of the mark as registered.

Examples where the distinctive character is altered:

Mark as registered	Mark as used	Case No
NN		28/06/2017, <a href="#">T-333/15</a> , NN / NN, EU:T:2017:444 appeal dismissed, 17/01/2018 <a href="#">C-536/17 P</a> , EU:T:2018:14
<p>G&amp;S: Class 36</p> <p><i>Territory:</i> Spain</p> <p><i>Assessment:</i> The word mark 'núñez i navarro' is always placed below a circle containing the letters 'nn' and occupies a central position. Moreover, the word element 'núñez i navarro' is much larger than the word mark 'nn', both in terms of width and the number of characters each contains. The letters 'nn' are very likely to be perceived as the initials of the surnames 'núñez' and 'navarro'. As surnames, these are not generic terms referring to the services in question and therefore have normal distinctive character. In the circumstances, the addition of the word element 'núñez i navarro' to the earlier mark changes its distinctive character (paras 43-46) – unacceptable variation.</p>		

Mark as registered	Mark as used	Case No
TACK		10/10/2018, <a href="#">T-24/17</a> , D-TACK / TACK et al., EU:T:2018:668
<p>G&amp;S: Class 16</p> <p><i>Territory:</i> Spain</p> <p><i>Assessment:</i> The invoices did not contain any indication of the earlier word mark TACK as such; that reference was made instead to product names. The juxtaposition of the element 'ceys' could not be seen as an irrelevant or negligible addition to the element 'tack'. Furthermore, on the invoices and in the brochures and catalogues the elements 'tack' and 'ceys' appeared together as one single term or as a single eight-letter word element. The element 'tackceys' on the invoices, and in the text of the brochures and catalogues, will be perceived as an <b>indivisible unit</b>, the two words being conjoined. On the packaging and in the extracts from websites, brochures and the catalogues, the word 'tack' systematically appears in combination with the word 'ceys' and in a figurative manner. None of the items of evidence referred to above shows the earlier word mark TACK used in isolation or, at least, away from the element 'ceys' (paras 54-63) – unacceptable variation.</p>		

Mark as registered	Mark as used	Case No
--------------------	--------------	---------

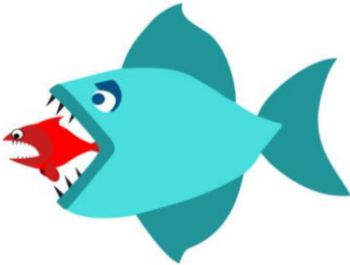

		<p>Invented example (CP8)</p>
<p>G&amp;S: Class 25</p> <p><i>Assessment:</i> The mark as registered is used with a distinctive figurative element (a blue fish) in such a manner that a single unit and a new concept is created in the mark as used (the big fish eating the small one) – unacceptable variation.</p>		

### 6.2.2.1.2 Mark as registered distinctive to a low degree

The following main scenarios can be distinguished.



- Addition of a non-distinctive or weakly distinctive element.
- Addition of a distinctive (interacting) element.

#### *Addition of a non-distinctive or weakly distinctive element*

When the mark as registered has a low degree of distinctive character, adding even a non-distinctive or weakly distinctive element may alter its distinctive character. Therefore, a case-by-case assessment is particularly important.

Examples where the distinctive character is altered:

Mark as registered	Mark as used	Case No
<p>CAFFE D'AUTORE</p>		<p>14/12/2018, <a href="#">R 932/2018-5</a>, La migliore interprete del caffè d'autore / Caffè d'autore (fig.) et al.</p>
<p>G&amp;S: Class 11: <i>Electric coffee machines for use in bars</i></p> <p><i>Territory:</i> EU</p> <p><i>Assessment:</i> In the mark as used the specific handwritten font style is the most distinctive element. This alters the distinctive character of the mark, as the use of this specific handwritten font style adds a distinctive element to the word mark which was not present in the form in which it was registered (paras 52-53) – unacceptable variation.</p>		

Mark as registered	Mark as used	Case No
	<p>(i)</p>  <p>(ii)</p> 	<p>19/06/2019, <a href="#">T-307/17</a>, DEVICE OF THREE PARALLEL STRIPES (fig.), EU:T:2019:427</p>
<p>G&amp;S: Class 25</p> <p>Territory: EU</p> <p><i>Assessment:</i> The following considerations are made in the context of <a href="#">Article 7(3) EUTMR</a>, applied by analogy to <a href="#">Article 18(1)(a) EUTMR</a> (para. 58). The mark at issue is a purely figurative mark presenting very few characteristics. One of those characteristics is the use of three black stripes against a white background. That characteristic gives rise to a specific contrast between, on the one hand, the three black stripes and, on the other hand, the white background and the white spaces separating those stripes. In those circumstances, <b>having regard, in particular, to the extreme simplicity of the mark at issue and the significance of the characteristic described above</b>, the act of reversing the colour scheme, even if a sharp contrast between the three stripes and the background is preserved, cannot be described as an insignificant variation as compared to the registered form of the mark at issue. It follows that the use of the mark in the form of three white (or light) stripes against a black (or dark) background alters the distinctive character of the mark as registered (paras 76-78) – unacceptable variation.</p>		



Mark as registered	Mark as used	Case No
<p>FLAVOUR AND AROMA</p>		<p>Invented example (<a href="#">CP8</a>)</p>

G&S: Class 31

*Territory:* English-speaking public

*Assessment:* The mark as registered has a low degree of distinctive character. The added element BAA-naa-NAA, which also has a low degree of distinctive character, is placed at the beginning and interacts with the mark as registered by creating a new concept – unacceptable variation.

Example where the distinctive character is not altered:

Mark as registered	Mark as used	Case No
	<p>(i)</p>  <p>(ii)</p> 	<p>13/09/2016, <a href="#">T-146/15</a>,                  DARSTELLUNG EINES                  VIELECKS (fig.), EU:T:2016:469</p>

G&S: Classes 9, 24, 25 and 42

*Territory:* EU

*Assessment:* The mere addition to the registered mark of a component lacking distinctive character, such as a circle, does not alter the distinctive character of the mark. The distinctive and dominant component of the mark as used is the element that constitutes the mark as registered, which remains clearly recognisable. Similarly, the use of the colour blue is not particularly original and does not alter the distinctive character of the mark as registered (paras 41-55) – acceptable variation.

*Addition of a distinctive (interacting) element*

The addition of a distinctive element to a mark that has a low degree of distinctive character generally results in an interaction between the two, such that the mark as registered will no longer be perceived independently. This alters the distinctive character of the mark as registered.

Example where the distinctive character is altered:

Mark as registered	Mark as used	Case No
--------------------	--------------	---------

		<p>28/02/2017,  <a href="#">T-766/15</a>,          REPRÉSENTATION DE SEMIS          DE POISSONS DORÉS SUR          FOND BLEU (fig.),          EU:T:2017:123</p>
<p>G&amp;S: Classes 29, 30 and 31</p> <p><i>Territory:</i> EU</p> <p><i>Assessment:</i> The mark as registered, a pattern of golden fish seedlings on a blue background, has a low degree of distinctive character. The public will perceive this element as decorative or intended to serve as a background. The distinctive mark 'LABEYRIE' appears prominently in a central position on the packaging of the goods and superimposed over the mark as registered (paras 50-54, 59-60) – unacceptable variation.</p>		

#### 6.2.2.2 Omissions

The omission of an element contributing to the distinctive character of the mark as registered is likely to alter its distinctive character.

##### 6.2.2.2.1 Mark as registered distinctive to an average degree

The following main scenarios can be distinguished.

- Omission of a non-distinctive element
- Omission of a weakly distinctive element
- Omission of a symbol or other orthographic character
- Omission of a distinctive element

##### *Omission of a non-distinctive element*

Where the omitted element is non-distinctive, the distinctive character of the mark as registered will not be altered.

Examples where the distinctive character is not altered:

Mark as registered	Mark as used	Case No
	Diacol	24/01/2017, <a href="#">T-258/08</a> , DIACOR / DIACOL, EU:T:2017:22

G&S: Class 5

Territory: Portugal



*Assessment:* Omitting the word 'Portugal', which is descriptive of the origin of the goods, does not affect the distinctive character of the mark as registered (para. 38) – acceptable variation.

Mark as registered	Mark as used	Case No
		29/09/2011, <a href="#">T-415/09</a> , Fishbone, EU:T:2011:550  confirmed 18/07/2013, <a href="#">C-621/11 P</a> , Fishbone, EU:C:2013:484

G&S: Class 25

Territory: Greece

*Assessment:* Omitting the slightly stylised word 'Beachwear', since it is descriptive of the kind of goods at issue, does not affect the distinctive character of the mark as registered (paras 62-63) – acceptable variation.

Mark as registered	Mark as used	Case No
		24/11/2005, <a href="#">T-135/04</a> , Online Bus, EU:T:2005:419

G&S: Classes 35, 40, 41 and 42



*Territory:* Germany

*Assessment:* The word elements ‘Betreuungsverbund für Unternehmer und Selbständige e.V.’ (meaning ‘Association for the assistance of businessmen and the self-employed, registered association’), written in small characters and occupying a secondary position in the mark as registered, are descriptive of the services at issue. Omitting this element does not alter the distinctive character of the mark as registered (paras 36-37) – acceptable variation.

### *Omission of a weakly distinctive element*

Where the omitted element has a low degree of distinctive character, the distinctive character of the mark as registered will normally not be altered. However, where that weakly distinctive element contributes significantly to the distinctive character of the mark as registered, is visually dominant or interacts with other elements, a different outcome may be justified. Therefore, a case-by-case assessment is particularly important.

Examples where the distinctive character is not altered:



Mark as registered	Mark as used	Case No
	(i) vieta (ii) 	10/12/2015, <a href="#">T-690/14</a> , Vieta, EU:T:2015:950

G&S: Class 9



*Territory:* EU

*Assessment:* The distinctive character of the mark is essentially derived from the word ‘vieta’ and not from the figurative elements. This word element is highly distinctive and occupies an important position in the overall impression created by the mark as registered, while the figurative elements have only a low degree of distinctive character and occupy a purely ancillary position in the overall impression. These figurative elements, including the typeface used, have a relatively marginal visual impact. The rectangular border does not present any originality in relation to usual commercial use. As regards the remaining figurative elements – the grey rectangles separating the letters of the word ‘vieta’ and the white rectangles in the middle of the sides of the rectangular border – they are very small in size, are not striking and do not present any originality (paras 47 and 48) – acceptable variation.

Mark as registered	Mark as used	Case No
--------------------	--------------	---------

	<p>(i)</p>  <p>(ii)</p> 	<p>14/12/2016, <a href="#">T-397/15</a>, PAL (fig.), EU:T:2016:730</p>
<p>G&amp;S: Class 7</p> <p>Territory: EU</p> <p><i>Assessment:</i> The figurative element of the mark as registered is essentially a frame highlighting the presence of the distinctive word element 'pal'. It will be perceived as being purely decorative. Omitting that element does not alter the distinctive character of the mark as registered (paras 32-38) – acceptable variation.</p>		

Example where the distinctive character is altered:

Mark as registered	Mark as used	Case No
		<p>Invented example (<a href="#">CP8</a>)</p>
<p>G&amp;S: Class 9</p> <p>Territory: English-speaking public</p> <p><i>Assessment:</i> The distinctive character of the mark as registered essentially derives from the combination of the verbal element 'BUBBLEKAT' and the other elements in the mark. Despite the low degree of distinctive character of the other elements, they interact and are visually dominant due to their size and prominent position. Omitting those elements alters the distinctive character of the mark as registered – unacceptable variation.</p>		



*Omission of a symbol or other orthographic character*

Omitting a punctuation mark, orthographic character (such as an apostrophe, accent, hyphen or space) or other symbols (such as the plural or possessive symbol or the abbreviated company form) does not normally alter the distinctive character of the mark as registered.

Examples where the distinctive character is not altered:

Mark as registered	Mark as used	Case No
Stöckert	(i) Stockert (ii) Stoeckert	22/04/2020, <a href="#">R 1061/2018-5</a> , STOCKERT medical solutions (fig.) / Stöckert
<p>G&amp;S: Classes 9 and 10</p> <p><i>Territory:</i> EU</p> <p><i>Assessment:</i> The element 'STOCKERT' is clearly the mark's dominant, most eye-catching element. The addition or deletion of the umlaut 'Ö' does not affect the distinctive character of the word element because the two small dots above the 'O' in the mark as registered are not a dominant or eye-catching element, although, when present, they will be noted, especially by the German-speaking public. Consequently, the suppression of an 'umlaut', or the conventional substitution of the letter 'ö' by the diphthong 'oe' are not considered to alter the distinctive character of the mark as registered (para. 55) – acceptable variation.</p>		

Mark as registered	Mark as used	Case No
PELASPAN-PAC	PELASPAN PAC	22/03/2013, <a href="#">R 1986/2011-4</a> , PELASPAN / PELASPAN et al.
<p>G&amp;S: Class 17</p> <p><i>Territory:</i> Benelux</p> <p><i>Assessment:</i> The use of the mark as registered without the hyphen connecting the elements 'PELASPAN' and 'PAC' does not alter its distinctive character (para. 25) – acceptable variation.</p>		

Mark as registered	Mark as used	Case No
		29/04/2010, <a href="#">R 877/2009-1</a> , Kaiku Bifi actiVium (fig.) / Bi-Fi (fig.) et al.
<p>G&amp;S: Class 29</p> <p><i>Territory:</i> Germany, Spain, France, Italy, Austria and Portugal</p> <p><i>Assessment:</i> The typeface has been modernised but the letters keep their rounded shape and the deletion of the hyphen may pass unnoticed. The distinctive character of the mark as registered is still based on the large black letters 'Bi Fi', the 'B' and 'F' being in upper case and the two 'i' letters in lower case, on a white background and outlined in silver. The orange background is merely the colour of the product packaging (para. 45) – acceptable variation.</p>		





Mark as registered	Mark as used	Case No
ΑΡΑΛΙΑ-ΑΠΑΛΙΑ	ΑΡΑΛΙΑ	15/09/2011, <a href="#">R_2001/2010-1</a> , ΑΡΑΝΙ / ΑΡΑΛΙΑ-ΑΠΑΛΙΑ
<p>G&amp;S: Class 30</p> <p>Territory: Greece</p> <p>Assessment: Omitting the transliteration of the term in Greek characters does not alter the distinctive character of the mark as registered – acceptable variation.</p>		

### *Omission of a distinctive element*

Omitting a distinctive element, whether it be a word or a figurative element, usually alters the distinctive character of the mark as registered even when such elements are not dominant, provided they are not negligible.

Examples where the distinctive character is altered:

Mark as registered	Mark as used	Case No
		04/05/2012, <a href="#">R_562/2012-2</a> , LT LIGHT-THECNO (fig.) / LIGHT TECHNOLOGY (fig.) et al.
<p>G&amp;S: Class 9</p> <p>Territory: Spain</p> <p>Assessment: The verbal elements 'light technology' have been omitted in the mark as used. Considering the importance in a composite mark of the verbal elements, by which the relevant public normally refer to such marks, the fact they are foreign words unlikely to be understood by the Spanish public and the way they are integrated into the figurative mark, omitting these word elements alters the distinctive character of the mark as registered (paras 27 and 32) – unacceptable variation.</p>		

Mark as registered	Mark as used	Case No
--------------------	--------------	---------

 <p><b>Sabores de Navarra</b></p> <p><i>La Sabiduría del Sabor</i></p>		<p>21/01/2015, <a href="#">T-46/13</a>, KIT, EL SABOR DE NAVARRA, EU:T:2015:39</p>
<p>G&amp;S: Class 29</p> <p><i>Territory:</i> EU (evidence focusing on Spain)</p> <p><i>Assessment:</i> Firstly, the words ‘Sabores de Navarra’ (tastes/flavours of Navarra) refer to sensations or impressions evoking a region of northern Spain. Thus, the elements can be perceived by the Spanish-speaking public as descriptive of the geographical origin of the goods in question. Moreover, the word ‘sabores’ (flavours) may be perceived as an indication of product quality, i.e. flavour. It follows that the elements ‘Sabores de Navarra’ must be regarded as essentially descriptive.</p> <p>The elements ‘La Sabiduría del Sabor’, given the meaning of the word ‘Sabiduría’ (wisdom) and the word ‘sabor’ (flavour), constitute a play on words and cannot be considered descriptive. It follows that the distinctiveness of the mark as registered comes essentially from the words ‘La Sabiduría del Sabor’ (paras 31-45) – unacceptable variation.</p>		

Mark as registered	Mark as used	Case No
FASHION TV	FASHION	13/05/2020, <a href="#">R 1221/2018-4</a> , Fashion TV
<p>G&amp;S: Classes 32 and 33</p> <p><i>Territory:</i> EU</p> <p><i>Assessment:</i> For a line of beverages which is described in the evidence as ‘a new brand of fashionable drinks’, the word ‘FASHION’ alone has very little, if any, distinctive character at all. By contrast, the word ‘TV’ neither alludes to drinks nor to the notion of fashion. As such, the word element ‘TV’ constitutes not only a distinctive element, but the most distinctive element of the mark at hand (para. 34) – unacceptable variation.</p>		

Mark as registered	Mark as used	Case No
--------------------	--------------	---------

	<p>ESCORPION</p>	<p>28/03/2007, <a href="#">R 1140/2006-2</a>, SCORPIO / ESCORPION (fig.)</p>
---	------------------	--

G&S: Classes 1, 3 and 4

*Territory:* Spain

*Assessment:* The mark as registered is strongly characterised by the presence of the figurative element. However, the documents submitted do not show any use of the figurative element contained in the mark as registered (paras 19-20) – unacceptable variation.



Mark as registered	Mark as used	Case No
		<p>31/03/2020, <a href="#">R 2111/2019-4</a>, natek (fig.) / Natec Ingenieros (fig.)</p>

G&S: Class 42

*Territory:* Spain

*Assessment:* The figurative device in the mark as registered will not be seen as purely ornamental or decorative. It is a very unique drawing combining various lines, shapes and colours which are visually quite eye-catching and endowed with personality and their own distinctive character. It has a certain degree of creativity and artistic imagination. It occupies nearly half of the mark. Consequently, it cannot be considered as negligible. Since the figurative element is visually dominant and is not negligible, omitting it alters the distinctive character of the mark as registered (paras 26-28) – unacceptable variation.

Mark as registered	Mark as used	Case No
--------------------	--------------	---------

		<p>15/12/2015, <a href="#">T-83/14</a>, ARTHUR &amp; ASTON / Arthur, EU:T:2015:974          appeal dismissed, 15/06/2016, <a href="#">C-94/16 P</a>, ARTHUR &amp; ASTON / Arthur, EU:C:2016:461</p>
<p>G&amp;S: Class 25  <i>Territory:</i> France  <i>Assessment:</i> The graphic element of the mark as registered, consisting of a stylised signature, disappears entirely from the mark as used and is replaced by a radically different graphic element which is very classical, symmetrical and static. The mark in its registered form attracts attention by its asymmetry and the dynamism conferred by the movement of the letters from left to right. The abovementioned differences are not negligible and the marks cannot be regarded as being broadly equivalent within the meaning of the case-law (paras 22-24) – unacceptable variation.</p>		

**6.2.2.2.2 Mark as registered distinctive to a low degree**

The following main scenarios can be distinguished.

- Omission of a non-distinctive distinctive element
- Omission of a weakly distinctive element

As a mark that has a low degree of distinctive character contains no elements of average distinctive character, the scenario of ‘omission of a distinctive element’ does not exist.

*Omission of a non-distinctive element*

When the mark as registered has a low degree of distinctive character and the omitted element is not distinctive, generally, the distinctive character of the mark as registered will not be altered. However, a different outcome may be justified in cases where the distinctive character of the mark as registered stems exclusively from the combination of non-distinctive elements.

Example where the distinctive character is altered:

Mark as registered	Mark as used	Case No
--------------------	--------------	---------

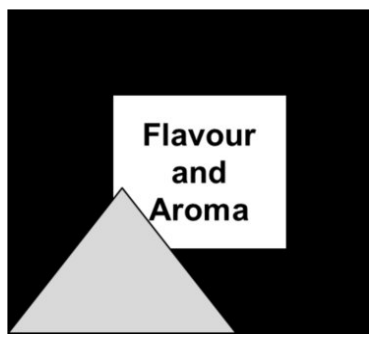
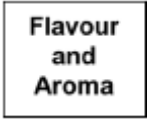
		<p>Invented example ( <a href="#">CP8</a> )</p>
<p>G&amp;S : Class 30</p> <p>Territory : English-speaking public</p> <p>Assessment: The distinctive character of the mark as registered derives from the combination of simple geometric shapes and descriptive words. The combination of such elements renders the mark as a whole distinctive, such that the omission of part of those elements alters the distinctive character of the mark – unacceptable variation.</p>		

*Omission of a weakly distinctive element*

When the mark as registered has a low degree of distinctive character, the omission of a weakly distinctive element, may result in an alteration of the distinctive character of the mark as registered, particularly if the omitted element is visually dominant or in cases when the distinctive character of the mark as registered stems from the combination of elements with a low degree of distinctive character. Therefore, a case-by-case assessment is particularly important.



Examples where the distinctive character is altered:

Mark as registered	Mark as used	Case No
		<p>15/09/2015, <a href="#">T-483/12</a> , LOTTE (fig.) / KOALA SCHÖLLER (fig.), EU:T:2015:635</p>

G&S : Class 30

*Territory* : Germany

*Assessment*: The mark is registered as a figurative mark and not as a three-dimensional mark with a hexagonal shape. Neither does the mark include a representation of two equilateral hexagonal panels, joined respectively on one sixth on the upper side and one sixth on the lower side of the reproduction of that mark, indicating that when all the panels are folded, they can form a hexagonal box. The representations of the packaging, as shown by the evidence, do not reproduce the triple effect created by the image of the three rectangular panels, which characterises that mark. This alters the distinctive character of the mark as registered (paras 111-117) – unacceptable variation.

Mark as registered	Mark as used	Case No
		<p>Invented example ( <a href="#">CP8</a> )</p>

G&S : Class 31

*Assessment* : The distinctive character of the sign as registered derives from a combination of non-distinctive and weakly distinctive elements, namely the word 'Bio' and the stylisation of the letter O resembling a cat. The combination of both elements renders the mark as a whole distinctive – unacceptable variation.

### 6.2.2.3 Modification of other characteristics

Changing the position or proportions of the elements of the mark as registered or switching between upper/lower case typeface, as long as it does not significantly depart from the usual way of writing, does not, in general, affect the distinctive character of the mark as registered.

However, irregular capitalisation or other additions that may influence how the elements are perceived (e.g. where the inverse order of the verbal elements leads to a different meaning or where a graphically highlighted part of the verbal element has a meaning of its own) may lead to a different conclusion.



Examples where the distinctive character is not altered:



Mark as registered	Mark as used	Case No
--------------------	--------------	---------

<p>DRINKFIT</p>		<p>12/12/2014, <a href="#">T-105/13</a>, TrinkFix, EU:T:2014:1070</p>
<p>G&amp;S: Class 29</p> <p><i>Territory:</i> EU</p> <p><i>Assessment:</i> The labels on bottles of beverages are narrow, so it is not unusual for a word mark to be written on two lines. The addition of the semi-circular graphical element does not change the overall impression of the mark (paras 47 and 49) – acceptable variation.</p>		

Mark as registered	Mark as used	Case No
<p>PALMA MULATA</p>		<p>12/03/2014, <a href="#">T-381/12</a>, EU:T:2014:119</p>
<p>G&amp;S: Class 33</p> <p><i>Territory:</i> EU</p> <p><i>Assessment:</i> The different arrangement and proportions of the word elements 'PALMA' and 'MULATA' in the mark as used do not introduce a change such as to alter the distinctive character of the mark as registered (paras 34-36) – acceptable variation.</p>		

Mark as registered	Mark as used	Case No
--------------------	--------------	---------

		<p>24/11/2005,  <a href="#">T-135/04</a>,                  Online Bus, EU:T:2005:419</p>
<p>G&amp;S: Classes 35, 40, 41 and 42</p> <p><i>Territory:</i> Germany</p> <p><i>Assessment:</i> Both the registered and the used form of the mark include the word 'BUS' and the figurative element of 'three interlaced triangles'. The presentation of the elements is not particularly original or unusual in either form. The variation in them does not affect the distinctive character of the trade mark. (para. 35) – acceptable variation.</p>		

Mark as registered	Mark as used	Case No
<p>AD-1841-TY</p>	<p>(i)</p>  <p>(ii)</p> 	<p>10/10/2017, <a href="#">T-233/15</a>, 1841,                  EU:T:2017:714</p>



G&S: Class 25

*Territory:* France

*Assessment:* The three principal components of the mark as registered, namely the elements 'AD', '1841' and 'TY' are always present at the same time in the marks as used, although a certain difference in positioning and size and some specific stylisation may be noted. Moreover, they remain legible and identifiable in the forms used (paras 73-76) – acceptable variation.

Example where the distinctive character is altered:

Mark as registered	Mark as used	Case No
LOVE YOUNG	YOUNG LOVE	Invented example (CP8)
<p>G&amp;S: Class 25</p> <p><i>Territory:</i> English-speaking public</p> <p><i>Assessment:</i> Although both verbal elements of the sign as registered are present in the mark as used, their use in an inverse order changes the meaning of the mark as registered – unacceptable variation.</p>		

### 6.3 Use in connection with the registered goods and services

In accordance with [Article 18 EUTMR](#), the mark must be used for the goods or services for which it is registered in order to be enforceable. In accordance with the first sentence of [Article 47\(2\) EUTMR](#), the earlier registered mark must have been put to genuine use in connection with the goods or services in respect of which it is registered and which the opponent cites as justification for its opposition. The third sentence of [Article 47\(2\) EUTMR](#) stipulates that if the earlier trade mark has been used for part only of the goods or services for which it is registered it will, for the purposes of the examination of the opposition, be deemed to be registered for only that part of the goods or services.

As the General Court stated in the *Aladin* case:

The provisions of Article 43 of Regulation No 40/94 [now [Article 47 EUTMR](#)] allowing an earlier trade mark to be deemed to be registered only in relation to the part of the goods or services in respect of which genuine use of the mark has been established (i) are a **limitation on the rights** which the proprietor of the earlier trade mark gains from his registration ..., and (ii) must be reconciled with the legitimate interest of the proprietor in being able in the future to **extend his range of goods or services**, within the confines of the terms describing the goods or services for which the trade mark was registered, by using the protection which registration of the trade mark confers on him.

That is particularly so when, as here, the goods and services for which the trade mark has been registered form a sufficiently narrowly-defined category.

(14/07/2005, [T-126/03](#), Aladin, EU:T:2005:288, § 51, emphasis added.)

The analysis of genuine use must in principle extend to all of the registered goods and/or services on which the opposition is based and for which the EUTM applicant has made an explicit request for proof of use. However, in situations where it is clear that likelihood of confusion can be established on the basis of **some** of the earlier goods and/or services, the Office's analysis of genuine use need not extend to all the earlier goods and/or services but instead may focus on only those goods and/or services sufficient for establishing identity/similarity to the contested goods and/or services.

In other words, since likelihood of confusion can be established on the basis of a finding of genuine use for some of the earlier goods and/or services, it is unnecessary to examine the evidence of use submitted by the opponent with respect to the remaining earlier goods and/or services.

The following sections include a number of guidelines to help establish whether the earlier trade mark has been effectively used for the registered goods and services. For further details, see [the Guidelines, Part C, Opposition, Section 2, Double Identity and Likelihood of Confusion, Chapter 2, Comparison of Goods and Services](#) and, in particular, the practice regarding the use of all the general indications in the class heading, and [the Guidelines, Part B, Examination, Section 3, Classification](#).

### 6.3.1 Comparison between goods/services used and specification of goods/services

It must always be carefully assessed whether the goods and services for which the mark has been used fall within the category of the registered goods and services.

#### Examples

Case No	Registered G&S	Used G&S	Comment
18/01/2011, <a href="#">T-382/08</a> , Vogue	<i>Footwear.</i>	<i>Retail of footwear.</i>	Not OK (paras 47, 48).
13/05/2009, <a href="#">T-183/08</a> , Jello Schuhpark II	<i>Footwear.</i>	<i>Retail services regarding footwear.</i>	Not OK (para. 32)
08/11/2001, <a href="#">R 807/2000-3</a> , DEMARA / DEMAR Antibioticos, S.A.	<i>Pharmaceuticals, veterinary and disinfectant products.</i>	<i>Napkins and napkin pants for incontinence.</i>	Not OK, even though the specific goods might be distributed by pharmacies (paras 14, 16).

Case No	Registered G&S	Used G&S	Comment
03/10/2008, <a href="#">R 1533/2007-4</a> , Geo Madrid (fig.) / GEO	<i>Telecommunication services in Class 38.</i>	<i>Providing an internet shopping platform.</i>	Not OK (para. 16).
03/05/2004, <a href="#">R 68/2003-2</a> , SWEETIE / SWEETY	<i>Preserved, dried and cooked fruits and vegetables; concentrated citrus fruit and fruit extracts, preserves; sugar, biscuits, cakes, pastry and confectionery.</i>	<i>Dessert toppings that are strawberry, caramel or chocolate flavoured.</i>	Not OK (para. 20).
24/02/2010, <a href="#">R 1519/2008-1</a> , DADO / DODOT et al.	<i>Baby diapers of textile in Class 25.</i>	<i>Disposable diapers of paper and cellulose (Class 16).</i>	Not OK (para. 29).
18/06/2010, <a href="#">R 594/2009-2</a> , BANIF / BANIF (fig.)	<i>Administration, representation and general counsel in Class 35</i>  <i>Technical, economic and administrative projects in Class 42.</i>	<i>Administration of funds and personal assets or real estate affairs (Class 36).</i>	Not OK (para. 39).
31/05/2011, <a href="#">B 1 589 871</a>	<i>Electric switches and 'parts of lamps'.</i>	<i>Apparatus for lighting.</i>	Not OK.
25/11/2002, <a href="#">B 253 494</a>	<i>Education services.</i>	<i>Entertainment services.</i>	Not OK.
28/04/2011, <a href="#">B 1 259 136</a>	<i>Transportation and distribution services in Class 39.</i>	<i>Home delivery of goods purchased in a retail store.</i>	Not OK as the registered services are provided by specialist transport companies whose business is not the provision of other services, while the home delivery of goods purchased in a retail store is just an additional auxiliary service integrated in retail services.

Case No	Registered G&S	Used G&S	Comment
23/08/2012, <a href="#">R 1330/2011-4</a> , AF (fig.)	<i>Advertising, business management, business administration, office functions</i> in Class 35.	<i>Retail services.</i>	Not OK. If a trade mark is registered for the general indications in Class 35, but use is proven only for <i>retail services</i> for particular goods, this cannot amount to valid proof of use for any of the specific indications of Class 35 or the class heading as a whole (para. 25 by analogy).

### 6.3.2 Relevance of the classification

Although the Nice Classification was adopted for exclusively administrative purposes, its **class numbers and explanatory notes** may be relevant in order to determine the **nature and purpose** of the **goods or services** for which a trade mark is **registered** and for which **genuine use must be proven**. This is particularly the case where terms in the specification are general and may cover different goods or services (06/10/2021, [T-397/20](#), Juvederm, EU:T:2021:653, § 35).

For example, a trade mark is registered for '*bread*' in Class 30 and use is shown for '*soft pastries covered with icing or coated with chocolate*'. When it comes to deciding whether the latter products come within the term '*bread*', it is relevant that Class 30 contains a category for '*pastries*', to which those products belong for classification purposes, and another category '*bread*', to which they do not belong (01/09/2021, [T-697/20](#), Donas dulcesol / Dulcesol, EU:T:2021:526, § 38). Similarly, if a trade mark is registered for '*coffee based beverages*' in Class 30 and it is used for '*energy drinks flavoured with coffee*', this use cannot amount to genuine use of the former. This is because '*energy drinks*' are non-alcoholic beverages that fall within Class 32, whereas beverages with a coffee base, which are included in Class 30 and expressly excluded from Class 32, refer more to beverages in which coffee constitutes the predominant and characteristic element (10/11/2021, [T-758/20 & T-759/20](#), Monster, EU:T:2021:776, § 49).

The impact of classification is even more apparent when similar categories of goods or services have been **classified in different classes** because the **specific purpose differs**. For instance, '*footwear*' can be classified in several classes depending on the intended purpose: '*orthopaedic footwear*' in Class 10 and ordinary '*footwear*' in Class 25. In such cases, the class chosen can be crucial. If the mark is registered for '*footwear*' in Class 25, the class chosen indicates that these goods are ordinary

footwear. Consequently, if the evidence shows use for '*orthopedic footwear*' only, genuine use of the mark has not been proved.

Nevertheless, it can be that the term for which the mark is registered in accordance with the Nice Classification in force on the date of application of the mark **clearly** identifies goods or services that belong **to a different class** (06/10/2021, [T-372/20](#), Juvederm, EU:T:2021:652, § 56-57). In these exceptional cases, **the wording itself is decisive** to determine the actual scope of protection (see, to this effect, 06/10/2021, [T-397/20](#), Juvederm, EU:T:2021:653, § 45). For example, if '*orthopedic footwear*' is registered in Class 25 and the mark is used for orthopedic footwear (which clearly belongs to Class 10) genuine use would be shown. This is because the scope of protection of the specific term '*orthopedic footwear*' remains clear irrespective of the wrong class number (06/10/2021, [T-372/20](#), Juvederm, EU:T:2021:652, § 55, 62).

For more on the relevance of the Nice Classification see: [Part B, Examination, Section 3, Classification, paragraph 4.2.1, General principles](#) and [4.2.2 Influence of classification on the scope of protection; Part C, Opposition, Section 2, Double identity and likelihood of confusion, Chapter 2, Comparison of goods and services, paragraph 1.2.3, Conclusions to be drawn from the structure of the Nice Classification](#).

### 6.3.3 Use and registration for general indications in 'class headings'

Where a mark is registered under **all** or **part of** the general indications listed in the class heading of a particular class and where it has been used for several goods or services that are properly classified in the same class under one of these **general indications**, the mark will be considered as having been used for that specific **general indication**.

Example: The earlier mark is registered for *clothing, footwear, headgear* in Class 25. The evidence relates to 'skirts', 'trousers' and 'T-shirts'.

Conclusion: The mark has been used for *clothing*.

On the other hand, when a mark is registered for only **part** of the **general indications** listed in the class heading of a particular class but has been used only for goods or services which fall under **another** general indication of that same class, the mark will not be considered as having been used for the registered goods or services (see also [paragraph 6.3.4](#)).

Example: The earlier mark is registered for *clothing* in Class 25. The evidence relates to 'boots' only.

Conclusion: The mark has not been used for the goods for which it is registered.

### 6.3.4 Use for subcategories of goods/services and similar goods/services

This part deals with the extent of protection granted where there is use for subcategories of goods and of 'similar' goods (or services).

In general, it is not appropriate to accept proof of use for 'different' but somehow 'linked' goods or services as automatically covering registered goods and services. In

particular, the concept of **similarity of goods and services is not a valid consideration** within this context. The third sentence of [Article 47\(2\) EUTMR](#) does not provide any exception in this regard.

Example: The earlier mark is registered for *clothing* in Class 25. The evidence relates to 'boots' only.

Conclusion: The mark has not been used for the goods for which it is registered.

#### 6.3.4.1 Earlier mark registered for broad category of goods/services

In the *Aladin* case, the General Court held:

if a trade mark has been registered for a category of goods or services which is sufficiently broad for it to be possible to identify within it a number of sub-categories capable of being viewed independently, proof that the mark has been put to genuine use in relation to a part of those goods or services affords protection, in opposition proceedings, only for the sub-category or sub-categories to which the goods or services for which the trade mark has actually been used belong.

(14/07/2005, [T-126/03](#), *Aladin*, EU:T:2005:288, § 45; see also 16/07/2020, [C-714/18 P](#), *tigha / TAIGA*, EU:C:2020:573, § 43.)

Therefore, if the earlier mark has been registered for a **broad category** of goods or services but the opponent provides evidence of use only for specific goods or services **falling within this category**, this raises the question of whether the submitted evidence is to be regarded strictly as proof of use only for the particular goods or services, which are not mentioned as such in the list of goods or services, or for the broad category as specified in the registration.

The General Court further pointed out, on the one hand, that it is necessary to interpret the last sentence of [Article 47\(2\) EUTMR](#) as seeking to deny a trade mark extensive protection, if it has only been used in relation to part of the goods or services for which it is registered, merely because it has been registered for a wide range of goods or services. Therefore, it is necessary to take account of the breadth of the categories of goods or services for which the earlier mark is registered, in particular the extent to which the categories concerned are described in general terms for registration purposes, and to do so in the light of the goods or services for which genuine use has actually been established (paragraph 44).

On the other hand, it is not necessary for the opponent to file evidence of all the commercial variations of similar goods or services but merely of those goods or services that are sufficiently distinct to constitute coherent categories or subcategories (paragraph 46). The underlying reason is that in practice it is impossible for the proprietor of a trade mark to prove that the mark has been used for all conceivable variations of the goods concerned by the registration.

Thus, protection is available **only** for the subcategory or subcategories to which the used goods or services belong if:

1. a trade mark has been registered for a **category** of goods or services:

- a. that is sufficiently broad to cover a number of subcategories other than in an arbitrary manner;
  - b. that are capable of being perceived as being independent from each other;
- and
2. it can be shown that the mark has been genuinely used in relation to only **part** of the initial broad specification.

Appropriate reasoning should be given for defining the subcategories and, on the basis of the evidence submitted by the opponent, it must be explained whether use has been shown in relation to only **part** of the initial broad specification or subcategory/subcategories. See examples in [paragraph 6.3.4.3](#) below.

This is especially important in the case of trade marks registered for *pharmaceutical preparations*, which are usually used only for one kind of medicine for treating a certain disease (see the examples of *pharmaceutical preparations* in [paragraph 6.3.4.3](#) below).

On the other hand, the use for a whole category has to be accepted if there are examples of different kinds of products belonging to this category and there is no other subcategory that covers the different products.

Contested sign	Case No
CARRERA	09/09/2009, <a href="#">R 260/2009-4</a> , (revocation)
<p>The proven use of a trade mark for:</p> <ul style="list-style-type: none"> <li>• decorative lettering;</li> <li>• increased performance packages;</li> <li>• covers for storage compartments;</li> <li>• wheel sets and complete wheel sets for summer and winter; and</li> <li>• door sill cover plates</li> </ul> <p>was considered sufficient proof of use for <i>motor vehicle and land vehicle parts</i> overall, for which the mark was registered. The main arguments were that it was used for numerous different motor vehicle parts and the goods for which use had been proven thus covered a wide spectrum of motor vehicle parts: elements of the chassis, the bodywork, the engine, the interior design and decorative elements.</p>	

In the case of a mark registered for a **broad category of goods and services that is not sufficiently clear and precise** to enable the competent authorities and economic operators, on that sole basis, to determine the scope of protection, it should be possible, in principle, to determine the precise scope through proof of use (29/01/2020, [C-371/18](#), SKY, EU:C:2020:45, § 68-70; 04/03/2020, [C-155/18 P](#), [C-156/18 P](#), [C-157/18 P](#) & [C-158/18 P](#), BURLINGTON / BURLINGTON ARCADE et al., EU:C:2020:151, § 136). The general principles stated above apply. For further information on unclear and imprecise terms, see the Guidelines, [Part C, Opposition](#).



[Section 2, Double Identity and Likelihood of Confusion, Chapter 2, Comparison of Goods and Services, paragraph 1.5.2.](#)

6.3.4.2 Earlier mark registered for precisely specified goods/services

In contrast, proof of genuine use of the mark for some of the specified goods or services necessarily covers the **entire category** if:

1. a trade mark has been registered for goods or services **specified** in a relatively precise manner; so that
2. it is not possible, without any artificiality, to make any significant subdivisions within the category concerned (14/07/2005, [T-126/03](#), Aladin, EU:T:2005:288, § 45; 16/07/2020, [C-714/18 P](#), tigha / TAIGA, EU:C: 2020:573, § 42).

The decision should duly indicate in which cases it is considered impossible to make subdivisions and, if necessary, why.

6.3.4.3 Examples

In order to define adequate subcategories of general **indications**, the **criterion of the purpose or intended use of the product or service** in question is of fundamental importance, as consumers do employ this criterion before making a purchase (13/02/2007, [T-256/04](#), Respicur, EU:T:2007:46, § 29-30; 23/09/2009, [T-493/07](#), Famoxin, EU:T:2009:355, § 37). If the goods or services concerned have several purposes, it is not possible to create, in a non-arbitrary manner, separate subcategories by considering in isolation each of those purposes (16/07/2020, [C-714/18 P](#), tigha / TAIGA, EU:C: 2020:573, § 51).

**Other applicable criteria** for defining adequate subcategories could be the characteristics of the product or service, for instance the nature of the product or service or the target consumer of the product or service. The geographical origin of the goods is not relevant. Even if the geographical origin of wines is an important factor when they are being chosen, such a factor is not so important that wines with different appellations of origin could constitute subcategories of goods that could be viewed autonomously (30/06/2015, [T-489/13](#), VIÑA ALBERDI / VILLA ALBERTI, EU:T:2015:446, § 37).

Earlier sign	Case No
ALADIN	14/07/2005, <a href="#">T-126/03</a>



Earlier sign	Case No
<p>G&amp;S: <i>polish for metals</i> in Class 3.</p> <p>Assessment of PoU: the earlier mark was registered for <i>polish for metals</i> in Class 3, but was actually used genuinely only for <i>magic cotton</i> (a product for polishing metals consisting of cotton impregnated with a polishing agent). The Court held that 'polish for metals', which in itself is already a subcategory of the class heading term <i>polishing preparations</i>, is sufficiently precise and narrowly defined in terms of the function and intended purpose of the claimed goods. No further subcategory can be established without being artificial, and thus, use for the entire category of <i>polish for metals</i> was assumed.</p>	

Contested sign	Case No
PELLICO	15/06/2018, <a href="#">R 2595/2015-G</a> , PELLICO (fig.) Revocation
<p>G&amp;S: <i>footwear</i> in Class 25.</p> <p>Assessment of PoU: use has been proven for <i>women's footwear</i> only, which constitutes a sufficiently distinct subcategory within the broad category of <i>footwear</i>. The targeted consumer does not wish only to satisfy the needs of covering and protecting their own feet, but is looking specifically for ladies' shoes. Market realities also support such division: many shoe shops offer exclusively women's footwear or physically separate the women's footwear section from the rest (paras 32, 39-42).</p>	

Contested sign	Case No
Turbo	19/06/2007, <a href="#">R 378/2006-2</a> , TURBO Revocation
<p>G&amp;S: <i>clothing</i> in Class 25.</p> <p>Assessment of PoU: the Board found that, in addition to swimwear, other types of clothing were referred to in the invoices and could be found in the catalogues, for example t-shirts, Bermuda shorts, cycling shorts and female underwear (para. 21). Thus, the Board found that use of the contested mark had been proved for <i>clothing</i> (para. 22). The Board, moreover, found it almost impossible and certainly unduly onerous to impose on the proprietor of a registered EUTM for <i>clothing</i> the obligation to demonstrate use in all possible subcategories that could be endlessly subdivided by the applicant (para. 25).</p>	

Earlier sign	Case No
--------------	---------

	19/01/2009, <a href="#">R 1088/2008-2</a> , EPCOS (fig.) / E epco SISTEMAS (fig.); confirmed 15/12/2010, <a href="#">T-132/09</a> , Epcos, EU:T:2010:518
<p>G&amp;S: <i>measuring apparatus and instruments</i> in Class 9.</p> <p>Assessment of PoU: the mark was used for apparatus and parts thereof for the measurement of temperature, pressure and level. The contested decision considered that the original specification of the earlier mark for <i>measuring apparatus and instruments</i> was a 'very wide' one, and determined, applying the criteria established in the <i>Aladin</i> judgment, that use had in fact only been shown for a subcategory of goods, namely: <i>measuring apparatus, all being for the measurement of temperature, pressure and level; parts for the aforesaid apparatus</i>. The Board found that approach to be a reasonable one in the circumstances of the case and endorsed the reasoning and findings of the contested decision in this regard (para. 29).</p>	

Contested sign	Case No
ICEBERG	23/07/2009, <a href="#">R 1166/2008-1</a> , ICEBERG Revocation
<p>G&amp;S: <i>apparatus for heating, steam generating, refrigerating, drying, ventilating and water supply purposes</i> in Class 11.</p> <p>Assessment of PoU: the Board concluded that the trade mark use was only proven for fridges, freezers and air-conditioning modules for yachts and boats (para. 26). These goods were included in the subcategories <i>apparatus for heating</i> (insofar as an air-conditioning machine can also perform as a heater), <i>apparatus for refrigerating</i> (insofar as an air-conditioning machine, a fridge and a freezer can keep air/things cold), and <i>apparatus for ventilating</i> (insofar as an air-conditioning machine, a fridge and a freezer all include ventilation circuits), for which the mark was registered. Therefore, the Board thought it should remain registered for those subcategories (para. 27). However, the Board did not consider it appropriate to limit the scope of protection of the trade mark to <i>yachts and boats</i>. This would have further split the 'subcategories' and would amount to unjustified limitation (para. 28).</p> <p>Conclusion: use was considered proven for <i>apparatus for heating, refrigerating and ventilating</i>.</p>	

Contested sign	Case No
LOTUS	02/12/2008, <a href="#">R 1295/2007-4</a> , LOTUS Revocation

G&S: *outerwear and underwear, hosiery, corsets, neckties, braces, gloves, underclothes* in Class 25.

Assessment of PoU: no evidence was submitted in respect of the goods *corsets, neckties, braces*. None of the pieces of evidence submitted mentions these goods or refers to them. Use must be demonstrated for all goods or services for which the trade mark is registered. The trade mark is registered for *outerwear and underwear*, but also for specific products within this category — inter alia *corsets, neckties, braces*. Use for other goods is not sufficient to maintain protection under trade mark law for these goods, even if these other goods also fall under the category *outerwear and underwear*. The Invalidity Division, however, considered use to be sufficient because, according to the principles of the *Aladin* judgment (14/07/2005, [T-126/03](#), *Aladin*, EU:T:2005:288) the *corsets, neckties, braces* fall under the generic term of *outerwear and underwear*. While this is indeed true, this question is subordinate to examining whether the goods used can be subsumed under the claimed term at all. This is not the case for *corsets, neckties, braces*. If, alongside the broad generic term, the trade mark also explicitly claims specific goods covered by the generic term, it must also have been used for these specific goods in order to remain registered for them (para. 25).

Earlier sign	Case No
GRAF-SYTECO	16/12/2010, <a href="#">R 1113/2009-4</a> , GRAFSYSTEM / GRAF-SYTECO
<p>G&amp;S: <i>electric instruments (included in Class 9); optical, weighing, measuring, signalling and checking (supervision) instruments; data processing equipment and computers, in particular for operating, monitoring and checking machines, installations, vehicles and buildings; recorded computer programs; electronic counters</i> in Class 9, <i>repair services</i> in Class 37 and <i>computer programming</i> in Class 42.</p> <p>Assessment of PoU: the devices that the opponent has proven to have placed on the market fall under the wording of <i>hardware</i> as specified in Class 9. This is, however, a vast category, especially considering the massive development and high specialisation taking place in this field, which can be divided into subcategories according to the actual goods produced. In the present case, the goods must be limited to the automotive industry. As the opponent is obliged to provide a legal guarantee to clients, it can be considered that it has also proven use of the service relating to repair of the hardware in question (Class 37). The Board also found that <i>recorded computer programs</i> in Class 9 were a very broad category and had to be limited to the actual field of activity of the opponent (paras 30-31). No evidence was submitted for Class 42.</p>	

Earlier sign	Case No
HEMICELL	20/09/2010, <a href="#">R 155/2010-2</a> , HICELL (fig.) / HEMICELL

*G&S: foodstuffs for animals in Class 31, and animal foodstuffs, animal feed and non-medicated additives for animal feed; all included in Class 31.*

Assessment of PoU: the contested decision erred in considering that the earlier mark had been put to genuine use for *foodstuffs for animals in Class 31, and animal foodstuffs, animal feed and non-medicated additives for animal feed; all included in Class 31*, since this finding is contrary to the findings of the Court in *Aladin*. The reason given by the contested decision is not acceptable because it should have been tested whether or not the category of goods covered by the earlier mark was susceptible of being divided into independent subcategories and whether the goods for which use of the earlier mark had been proven could be classified in one of those. Therefore, the Board considers that the earlier EUTM is, for the purposes of examination of the opposition, deemed to be registered in respect of *additives for animal feed only in Class 31*.

Contested sign	Case No
VIGOR	18/11/2015, <a href="#">T-361/13</a> , VIGOR / VIGAR
<p><i>G&amp;S: all kinds of brushes and brush goods, for cleaning and hygiene purposes in Class 21.</i></p> <p>The proven use of a trade mark for brooms, brushes and sponges, among other goods, was considered sufficient proof of use for 'all kinds of brushes and brush goods, for cleaning and hygiene purposes', for which the mark was registered. The Court stated that these household and kitchen products do not constitute a category that is broad enough for it to be necessary to identify them within subcategories in which actual use had specifically to be proven. Rather, it must be held that it is not possible to make significant subdivisions within that category of goods.</p>	

### Pharmaceutical preparations

In a number of cases, the Court had to define adequate subcategories for *pharmaceutical preparations* in Class 5. It held that the purpose and intended use of a therapeutic preparation are expressed in its therapeutic indication. Thus, the *therapeutic indication* is the key for defining the relevant subcategory of pharmaceutical products. Other criteria (such as dosage form, active ingredients, whether it is sold on prescription or over the counter) are irrelevant in this regard.

The following subcategories for *pharmaceutical preparations* were assumed to be adequate by the Court:

Case No	Adequate	Non-adequate
13/02/2007, <a href="#">T-256/04</a> , Respicur	<i>Pharmaceutical preparations for respiratory illnesses.</i>	<i>Multi-dose dry powder inhalers containing corticoids, available only on prescription.</i>
23/09/2009, <a href="#">T-493/07</a> , Famoxin	<i>Pharmaceutical preparations for cardiovascular illnesses.</i>	<i>Pharmaceutical preparations with digoxin for human use for cardiovascular illnesses.</i>
16/06/2010, <a href="#">T-487/08</a> , Kremezin, EU:T:2010:237	<i>Pharmaceutical preparations for heart treatment.</i>	<i>Sterile solution of adenosine for use in the treatment of specific heart condition, for intravenous administration in hospitals.</i>
17/10/2006, <a href="#">T-483/04</a> , Galzin, EU:T:2006:323	<i>Calcium-based preparations.</i>	<i>Pharmaceutical preparations.</i>

### 6.3.5 Use of the mark on integral parts, aftersales services and second-hand market of the registered goods

In the *Minimax* judgment, the Court held that, in certain circumstances, use of the mark may be considered genuine also for 'registered' goods that had been sold at one time and were no longer available (11/03/2003, [C-40/01](#), *Minimax*, EU:C:2003:145, § 40 et seq.).

- This may apply where the proprietor of the trade mark under which such goods had been put on the market **sells parts** that are integral to the make-up or structure of the goods previously sold.
- The same may apply where the trade mark proprietor makes actual use of the mark for **aftersales services**, such as the sale of accessories or related parts, or the supply of maintenance and repair services.

Sign	Case No
Minimax	11/03/2003, <a href="#">C-40/01</a>

G&S: *fire extinguishers and associated products v components and after-sales services.*

Assessment of PoU: the authorisation for the fire extinguishers sold by Ansul under the Minimax trade mark expired in the 1980s. Since then, Ansul has not been selling fire extinguishers under that mark. However, Ansul nonetheless sold component parts and extinguishing substances for fire extinguishers bearing the mark to undertakings with responsibility for maintaining them. During the same period, it also maintained, checked and repaired equipment bearing the Minimax mark itself, used the mark on invoices relating to those services and affixed stickers bearing the mark and strips bearing the words 'Gebruiksklaar Minimax' (Ready for use Minimax) to the equipment. Ansul also sold these stickers and strips to undertakings that maintain fire extinguishers.

However, this finding of the Court should be interpreted **strictly** and applied only in very exceptional cases. In *Minimax*, the Court accepted use for goods other than those registered, which runs counter to the general rule laid down in [Article 47\(2\) EUTMR](#).

In the *Testarossa* judgment, the Court of Justice confirmed that, in principle, the subsequent **resale of second-hand goods** bearing the trade mark does not constitute genuine use (22/10/2020, [C-720/18 & C-721/18](#), *Testarossa*, EU:C:2020:854, § 55). However, it held that the resale of second-hand goods bearing the trade mark **by the proprietor** can be taken into account as evidence of use of that mark. The fact that the proprietor of the trade mark cannot prohibit third parties from using his trade mark in respect of goods already put on the market under that mark does not mean that he cannot use it himself in respect of such goods. If the proprietor of the trade mark concerned actually uses that mark, **in accordance with its essential function**, which is to guarantee the **identity of the origin** of the goods for which it was registered, when reselling second-hand goods, such use is capable of constituting 'genuine use' (22/10/2020, [C-720/18 & C-721/18](#), *Testarossa*, EU:C:2020:854, § 56-60).

#### 6.3.6 Use for the sale of the manufacturer's own goods

Retail services in Class 35 are defined in the explanatory note of the Nice Classification as

... the bringing together, for the benefit of others, of a variety of goods (excluding the transport thereof), enabling customers to conveniently view and purchase those goods; such services may be provided by retail stores, wholesale outlets, through vending machines, mail order catalogues or by means of electronic media, for example, through web sites or television shopping programmes.

It follows from that explanatory note that the concept of 'retail services' relates to **three essential characteristics**: firstly, the purpose of these services is the sale of goods to consumers; secondly, they are addressed to consumers with a view to enabling them to conveniently view and purchase the goods; and, thirdly, they are provided for the benefit of others (04/03/2020, [C-155/18 P](#), [C-156/18 P](#), [C-157/18 P](#) & [C-158/18 P](#), *BURLINGTON / BURLINGTON ARCADE et al.*, EU:C:2020:151, § 126). The '**others**'

benefiting from the ‘bringing together of a **variety** of goods’ are the various manufacturers looking for an outlet for their goods.

The Court has held that the objective of retail trade is the sale of goods to consumers. This includes, in addition to the legal sales transaction, all activity carried out by the trader for the purpose of encouraging the conclusion of such a transaction. Such activity consists, inter alia, in selecting an assortment of goods offered for sale and in offering a variety of services aimed at inducing the consumer to conclude the abovementioned transaction with the trader in question, rather than with a competitor (07/07/2005, [C-418/02](#), Praktiker, EU:C:2005:425, § 34). For example, the concept of ‘retail services’ includes a shopping arcade’s services aimed at consumers with a view to enabling them to conveniently view and purchase the goods, for the benefit of the businesses occupying the arcade concerned (04/03/2020, [C-155/18 P](#), [C-156/18 P](#), [C-157/18 P](#) & [C-158/18 P](#), BURLINGTON / BURLINGTON ARCADE et al., EU:C:2020:151, § 130). The Court has confirmed that services can also be the subject of retail trade as there are situations in which a trader selects and offers an assortment of third-party services so that the consumer can choose among those services from a single point of contact (10/07/2014, [C-420/13](#), Netto Marken-Discount, EU:C:2014:2069, § 34).

In the same way that advertising one’s own goods does not constitute use for advertising services in Class 35, there is no use for retail services in Class 35 where the manufacturer is merely selling its own goods from its shop or website. The sale by the manufacturer of its own goods is not an independent service but an activity covered by the protection conferred by registration for the **goods**. It would not be appropriate to equate the protection conferred by registration for goods in any of Classes 1 to 34 with that conferred by registration for Class 35 retail services. While manufacturers may provide ancillary services (such as maintaining an outlet with shop assistants, advertising, consultancy, after-sales services, etc.) in the course of the sale of their own goods, such activities fall within the concept of a remunerated ‘service’ only if they do not form an integral part of the offer for sale of the goods (10/07/2014, [C-421/13](#), Apple Store, EU:C:2014:2070, § 26). Consequently, if a manufacturer uses a trade mark in relation to activities that form an integral part of the offer for the sale of its own goods, there is no use for retail services of such goods in Class 35. This interpretation is also confirmed by the examples of (infringing) use provided in [Article 9\(3\) EUTMR](#).

Nor would such sales activity be in line with the definition of ‘retail services’ as provided in the explanatory note to the Nice Classification and interpreted by the Court, because it does not entail any benefit for third-party manufacturers. Therefore, an essential characteristic of retail services is missing.

Furthermore, genuine use must be consistent with the essential function of a trade mark. The trade mark used in relation to an outlet for the manufacturer’s own goods serves to distinguish those **goods** from goods of other manufacturers but not to distinguish the **services** provided through that outlet from those provided through other outlets. Manufacturers selling their own goods from their own shops compete on the market of the **goods** they are selling but do not compete on the **retail services** market, which targets third-party manufacturers. Operating a shop **exclusively** for the purpose

of selling the manufacturer's own goods excludes offering competing goods from third-party manufacturers.

However, genuine use for retail services should not be denied if the opponent, when bringing together goods offered by third parties, includes, in addition to goods offered by other traders, goods that it itself manufactures.

## 7 Use by the proprietor or on its behalf

### 7.1 Use by the proprietor

According to Articles [18\(1\)](#) and [47\(2\)](#) EUTMR, it is in general the owner who has to put the earlier registered mark to genuine use. These provisions also cover use of the mark by the previous owner during its ownership.

### 7.2 Use by authorised third parties

According to [Article 18\(2\) EUTMR](#), use of the mark with the consent of the proprietor is deemed to constitute use by the proprietor. This means that the owner must have given its consent **prior** to the use of the mark by the third party. Acceptance later is insufficient.

A typical case of use by third parties is use made by **licensees**. Use by companies **economically related** to the trade mark proprietor, such as members of the same group of companies (affiliates, subsidiaries, etc.) is similarly to be considered as authorised use (30/01/2015, [T-278/13](#), now, EU:T:2015:57, § 38). Where goods are produced by the trade mark proprietor (or with its consent), but subsequently placed on the market by **distributors** at wholesale or retail level, this is to be considered as use of the mark (17/02/2011, [T-324/09](#), Friboi, EU:T:2011:47, § 32; 16/11/2011, [T-308/06](#), Buffalo Milke, EU:T:2011:675, § 73).

At the **evidence** stage it is prima facie sufficient that the opponent only submits evidence that a third party has used the mark. The Office infers from such use, combined with the opponent's ability to present evidence of it, that the opponent has given prior consent.

This position of the Office was confirmed by judgment of 08/07/2004, [T-203/02](#), Vitafruit, EU:T:2004:225, § 25 (further confirmed 11/05/2006, [C-416/04 P](#), Vitafruit, EU:C:2006:310). The Court pointed out that it was unlikely that the proprietor of a trade mark would be in a position to submit evidence if the mark had been used against its wishes. There was all the more reason to **rely on that presumption**, given that the applicant did not dispute the opponent's consent.

However, if the Office has **doubts** or, in general, in cases where the applicant explicitly contests the opponent's consent, the burden is on the opponent to submit further



evidence that it gave its consent prior to use of the mark. In such cases, the Office gives the opponent a further period of 2 months for the submission of such evidence.

### **7.3 Use of collective and certification marks by authorised users**

**Collective marks** are generally used not by the proprietor association but rather by its members. As far as EU collective marks are concerned, this is reflected in [Article 78 EUTMR](#), which provides that use by any authorised person satisfies the user requirement.

**Certification marks** are not used by their proprietors but by authorised users, for the purpose of guaranteeing to consumers that the goods or services possess a particular characteristic. As far as EU certification marks are concerned, this is reflected in [Article 87 EUTMR](#), which provides that use by the authorised person in accordance with the regulations governing the use of the certification mark satisfies the user requirement.

## **8 Irrelevance of unlawful use**

Whether a mark has been used in a way that satisfies the use requirements of Articles [18](#) and [47](#) EUTMR requires a factual finding of genuine use. Use will be ‘genuine’ in this context even if the user violates legal provisions.

Use that is **deceptive** within the meaning of [Article 7\(1\)\(g\)](#) or [Article 58\(1\)\(c\) EUTMR](#) or under provisions of national law remains ‘genuine’ for the purpose of asserting earlier marks in opposition proceedings. The sanctions for deceptive use are invalidation or revocation, as the case may be, or a prohibition of use (provided for pursuant to [Article 137\(2\) EUTMR](#)).

The same principle applies where use is made under an illegal licensing arrangement (for example arrangements violating the competition rules of the Treaty on the Functioning of the European Union or national rules). Similarly, the fact that use may infringe third-party rights is also irrelevant.

## **9 Justification of non-use**

According to [Article 47\(2\) EUTMR](#), the opponent may alternatively prove that there are justifiable reasons for non-use of its earlier registered mark. These reasons cover, as mentioned in the second sentence of Article 19(1) of the TRIPS agreement, circumstances arising independently of the will of the owner of the trade mark that constitute an obstacle to the use of the trade mark.

As an exception to the obligation of use, the concept of proper reasons for non-use is to be interpreted rather narrowly.

'Bureaucratic obstacles' as such, that arise **independently of the will** of the trade mark proprietor, are not sufficient, unless they have a **direct relationship** with the mark, so much so that use of the trade mark depends on successful completion of the administrative action concerned. However, the criterion of a direct relationship does not necessarily imply that use of the trade mark is impossible; it might suffice that use is **unreasonable**. It must be assessed on a case-by-case basis whether a change in the undertaking's strategy to circumvent the obstacle under consideration would make use of the mark unreasonable. Thus, for example, the proprietor of a mark cannot reasonably be required to change its corporate strategy and sell its goods in its competitors' sales outlets (14/06/2007, [C-246/05](#), Le Chef de Cuisine, EU:C:2007:340, § 52).

## 9.1 Business risks

The concept of proper reasons must be considered to refer to circumstances arising independently of the will of the owner that make use of the mark impossible or unreasonable, rather than to circumstances associated with commercial difficulties it is experiencing (14/05/0008, [R 855/2007-4](#), PAN AM, § 27; 09/07/2003, [T-156/01](#), Giorgio Aire, EU:T:2003:198, § 41; 18/03/2015, [T-250/13](#), SMART WATER, EU:T:2015:160, § 67-69).

Thus, financial difficulties encountered by a company as a result of an economic recession or due to its own financial problems are not considered to constitute proper reasons for non-use within the meaning of [Article 47\(2\) EUTMR](#), as these kinds of difficulties constitute a natural part of running a business.

## 9.2 Government or court intervention

Import restrictions or other government requirements are two examples of proper reasons for non-use that are explicitly mentioned in the second sentence of Article 19(1) of the TRIPS agreement.

**Import restrictions** include a trade embargo affecting the goods protected by the mark.

Other **government requirements** can be a state monopoly, which impedes any kind of use, or a state prohibition of the sale of goods for reasons of health or national defence. Typical cases in this respect are regulatory procedures such as:

- clinical trials and authorisation for new medicines (18/04/2007, [R 155/2006-1](#), LEVENIA / LEVELINA); or
- the authorisation of a food safety authority, which the owner has to obtain before offering the relevant goods and services on the market.

Earlier sign	Case No
HEMICELL	20/09/2010, <a href="#">R 155/2010-2</a> , HICELL (fig.) / HEMICELL
<p>The evidence submitted by the opponent duly shows that use of the earlier marks for a food additive, namely, <i>zootechnical digestibility enhancer (feed enzyme)</i> was conditional upon prior authorisation, to be issued by the European Food Safety Authority following an application filed before that body. Such a requirement is to be deemed a government requirement in the sense of Article 19(1) TRIPS.</p>	

With regard to Court proceedings or interim injunctions, the following must be differentiated:

On the one hand, the mere threat of litigation or a pending cancellation action against the earlier mark should not exempt the opponent from the obligation to use its trade mark in the course of trade. It is up to the opponent, being the attacking party in opposition proceedings, to conduct an adequate risk assessment of its chances to prevail in the litigation proceedings and to draw the appropriate conclusions from this evaluation as to whether or not to continue with use of its mark (18/02/2013, [R 1101/2011-2](#), SMART WATER, § 40; 18/03/2015, [T-250/13](#), SMART WATER, EU:T:2015:160).

Earlier sign	Case No
HUGO BOSS	09/03/2010, <a href="#">R 764/2009-4</a> , HUGO BOSS / BOSS
<p>The national [French cancellation] proceedings brought against the opposing trade mark cannot be acknowledged as a proper reason for non-use (para. 19).</p> <p>The fact remains that proper reasons for non-use are only those outside the sphere and influence of the trade mark proprietor, for instance national authorisation requirements or import restrictions. These are neutral with regard to the trade mark to be used; they concern not the trade mark but the goods and services that the proprietor wishes to use. Such national authorisation requirements or import restrictions apply to the type or properties of the product to which the trade mark is affixed, and cannot be circumvented by choosing a different trade mark. In the present case, conversely, the trade mark proprietor could have readily manufactured cigarettes in France or imported them into France if it had chosen a different trade mark (para. 25).</p>	

Earlier sign	Case No
MANPOWER	18/06/2010, <a href="#">R 997/2009-4</a> , MOON-POWER / MANPOWER

According to [Article 9 EUTMR](#) and [Article 5 of Directive 2008/95/EC](#), the trade marks of third parties must not be infringed. The requirement not to infringe trade marks applies to any person using a name in the course of trade, regardless of whether it has itself applied for or been granted trade mark protection for that name. A person refraining from such infringements is acting not for 'proper reasons' but as ordered by law. Hence, even refraining from use that would otherwise infringe a right is not a proper reason (09/03/2010, [R 764/2009-4](#), HUGO BOSS / BOSS, § 22) (para. 27).

Nor is use in such instances 'unreasonable'. Persons who, as trade mark proprietors, are threatened with proceedings or an interim injunction if they start using the trade mark concerned, must consider the prospects of the action against them succeeding and can either capitulate (not start using the trade mark) or defend themselves against the complaint. In any event, they have to accept the decision of the independent courts, which may be in expedited proceedings. Nor, pending a decision at final instance, can they object that they must be protected by the fact that, until that decision becomes final, uncertainty is to be recognised as a proper reason for non-use. In fact, the issue of what should happen in the period between the filing of an action or the application for an interim injunction and the conclusive final decision is again to be left to the courts, in that they take decisions that are not yet final on provisional enforceability. The defendant is not entitled to ignore those decisions and be put in a position as if there were no courts (para. 28).

On the other hand, for example, an interim injunction or a restraining court order in insolvency proceedings, imposing a general prohibition of transfers or disposals on the trade mark owner, can be a proper reason for non-use because it obliges the opponent to refrain from using its mark in the course of trade. Use of the mark contrary to such a court order would make the trade mark owner liable to damage claims (11/12/2007, [R 77/2006-1](#), MISS INTERCONTINENTAL (fig.), § 51).

### **9.3 Defensive registrations**

The General Court has clarified that the existence of a national provision recognising what are known as 'defensive' registrations (i.e. of signs not intended to be used in trade on account of their purely defensive function in relation to another sign that is being commercially exploited) cannot constitute a proper reason for non-use of an earlier trade mark invoked as a basis of an opposition (23/02/2006, [T-194/03](#), Bainbridge, EU:T:2006:65, § 46).

### **9.4 Force majeure**

Further justifiable reasons for non-use are cases of *force majeure* that hinder the normal functioning of the owner's enterprise.

## 9.5 Consequences of justification of non-use

The existence of justified reasons does not mean that non-use during the period concerned is treated as equivalent to actual use, which would result in a new grace period beginning after the end of the period of justified non-use.

Rather, non-use during such period merely stops the 5-year period from running. This means that the period of justified non-use is not taken into account in calculating the grace period of 5 years.

In addition, the length of time during which justified reasons existed may be significant. Reasons for non-use existing during only part of the relevant 5-year-period may not always be considered justification for setting the proof-of-use requirement aside. In this context, the period of time during which these reasons were pertinent and the elapse of time since they no longer applied are of particular importance (01/07/1999, [B 2 255](#)).

## 10 Decision

### 10.1 Competence of the Office

The Office makes its own evaluation of the evidence of use submitted. This means that the probative value of the evidence submitted is evaluated independently of the observations submitted by the applicant in this respect. Assessment of the relevance, pertinence, conclusiveness and efficacy of evidence lies within the discretion and power of judgment of the Office, not the parties, and falls outside the adversarial principle that governs *inter partes* proceedings (01/08/2007, [R 201/2006-4](#), OCB (fig.) / O.C.B., OCB (fig.), § 19; 14/11/2000, [R 823/1999-3](#), SIDOL / SIDOLIN).

A declaration by the applicant concluding that use has been proved does not, therefore, have any effect on the Office's findings. The request for proof of use is a defence plea by the applicant. However, once the defence plea has been raised by the applicant, it is solely up to the Office to carry out the subsequent procedure and evaluate whether the evidence submitted by the opponent is to be regarded as of sufficient probative value. However, the applicant does have the possibility of formally withdrawing the request for proof of use (see [paragraph 3.4.4](#) above).

This is not contrary to [Article 95\(1\) EUTMR](#), which stipulates that in *inter partes* proceedings the Office is restricted in its examination to the facts, evidence and arguments provided by the parties and the relief sought. However, although the Office is bound by the facts, evidence and arguments provided by the parties, it is not bound by the legal value that the parties may give thereto. Hence, the parties may agree as to which facts have been proved or not, but may not determine whether or not these facts are sufficient to establish genuine use (01/08/2007, [R 201/2006-4](#), OCB (fig.) / O.C.B., OCB (fig.), § 19; 14/11/2000, [R 823/1999-3](#), SIDOL / SIDOLIN, § 20; 13/03/2001, [R 68/2000-2](#), MOBEC / NOVEX PHARMA).

## 10.2 Need for assessing proof of use

A decision on whether the obligation of having genuinely used the registered mark has been fulfilled is not always necessary.

When **proof of use** of the earlier rights has been requested by the applicant, the Office will also examine whether, and to what extent, use has been proved for the earlier marks, provided this is relevant for the outcome of the decision in question. The examination of proof of use is always necessary and obligatory in cases where the opposition is fully or partially successful on the basis of the earlier mark that was subject to the proof of use obligation.

The Office may decide not to assess the proof of use if it is irrelevant to the outcome of the opposition, for example:

- under the ground of [Article 8\(1\)\(b\) EUTMR](#) , if there is no likelihood of confusion between the contested mark and the earlier mark that is subject to the proof of use obligation (10/02/2021, [T-117/20](#) , PANTHÉ (fig.) / P PANTHER (fig.) et al., EU:T:2021:81, § 64);
- if the opposition is fully successful on the basis of another earlier mark, which is not subject to the proof of use obligation;
- if the opposition is fully successful on the grounds of [Article 8\(3\) and/or Article 8\(4\) EUTMR](#) ;
- under the ground of [Article 8\(5\) EUTMR](#) , if one of the necessary conditions for application of this ground is not fulfilled.

However, in the event that the earlier trade mark that was subject to the proof of use obligation was examined in the decision but the assessment of the proof of use has been omitted, this will be expressly stated in the decision with a brief justification.

## 10.3 Overall assessment of the evidence presented

As stated in more detail above (see [paragraph 2.2](#) above), the Office has to evaluate the evidence submitted with regard to place, time, extent and nature of use in an **overall assessment**. A separate assessment of the various relevant factors, each considered in isolation, is not suitable (17/02/2011, [T-324/09](#), Friboi, EU:T:2011:47, § 31).

The **principle of interdependence** applies, meaning that weak evidence with regard to one relevant factor (e.g. low sales volume) might be compensated by solid evidence with regard to another factor (e.g. continuous use over a long period of time).

All the circumstances of the specific case have to be taken into account **in conjunction with each other** in order to determine whether the mark in question has been genuinely used. The particular circumstances can include, for example, the specific features of the goods/services in question (e.g. low- or high-priced; mass products versus special products) or the particular market or business area.

**Indirect/circumstantial evidence**, under certain conditions even on its own, can also be suitable for proving genuine use.

As the Office does not assess commercial success, even minimal use (but not mere token or internal use) can be sufficient to be deemed 'genuine', as long as it is viewed as warranted in the economic sector concerned to maintain or acquire a share in the market.

The decision indicates what **evidence** was submitted. However, in general, only the evidence relevant for the conclusion is mentioned. If the evidence is found convincing, it suffices for the Office to indicate those documents that were used to come to this conclusion and why. If an opposition is rejected because the proof of use was not sufficient, neither likelihood of confusion nor [Article 8\(5\) EUTMR](#), if claimed, is to be addressed.

## 10.4 Treatment of confidential information

Pursuant to [Article 113\(1\) EUTMR](#), the Office must publish its decisions. On the other hand, pursuant to [Article 114\(4\) EUTMR](#), upon the prior request of a party with a special interest in keeping parts of the file confidential, the data concerned must be kept confidential vis-à-vis the public<sup>(85)</sup>. However, the need to keep certain data confidential does not exempt the Office from the obligation to state the reasons for its decisions.

Given the public nature of decisions, the justified interest of a party in keeping certain information confidential vis-à-vis the public has to be reconciled with the Office's duty to state reasons. It may be problematic to reason without divulging confidential business data, but this can be done by referring to those data in a general manner and without disclosing concrete data. For example, the decision may refer to the invoices submitted, indicate the time span, frequency and territory of sales, the significance of the sales volumes they represent and whether they are sufficient to support the finding of genuine use. What is important is that the decision reflects that the relevant business data were considered and assessed in relation to the kind of goods and services at issue and the characteristics of the relevant market. Simply stating whether the relevant factors (time, place, nature and extent of use) have been fulfilled or not is not sufficient to support the final conclusion on the issue of genuine use.

Finally, it must be clarified that, notwithstanding the confidentiality of an entire submission or annex, data contained therein that are clearly within the public domain (e.g. in the form of press extracts) can be referred to in the decision.

---

<sup>85</sup> Note, however, that no parts of the file can be kept confidential vis-à-vis the other party to the proceedings due to the right of defence (see the Guidelines, [Part C, Opposition, Section 1, Opposition Proceedings, paragraph 4.4.4](#)).

## 10.5 Examples

The following cases present some of the decisions of the Office and the Court (with different outcomes) where the overall assessment of the submitted evidence was important.

### 10.5.1 Genuine use accepted

Case No	Comment
17/02/2011, <a href="#">T-324/09</a> , Friboi, EU:T:2011:47	The opponent (Fribo Foods Ltd.) submitted <b>several invoices</b> relating to large quantities of goods, addressed to its distribution company (Plusfood Ltd.), which belongs to the same group (Plusfood Group). It is not disputed that the distribution company put the products on the market later. Furthermore, the opponent presented <b>undated brochures</b> , a <b>press clip</b> and three <b>price lists</b> . With regard to the 'internal' invoices, the Court held that the producer-distributor-market chain was a common method of business organisation, which could not be regarded as purely internal use. The undated brochures had to be seen in conjunction with other dated evidence such as invoices and price lists and, therefore, might still be taken into consideration. The Court accepted genuine use and stressed that an overall assessment implied that all the relevant factors be viewed as a whole and not in isolation.



Case No	Comment
02/05/2011, <a href="#">R 872/2010-4</a> , CERASIL / CERATOSIL	The opponent submitted inter alia about <b>50 invoices</b> , not in the language of proceedings. The names of the addressees as well as the quantities sold were blacked out. The Boards held that standard invoices containing the usual information (date, indication of seller's and buyer's name/ address, product concerned, price paid) did not require a translation. Even though the names of the addressees and the quantities sold were blacked out, the invoices nevertheless confirmed the sale of 'CERATOSIL' products, measured in kilograms, to companies throughout the relevant territory during the relevant period. Together with the remaining evidence ( <b>brochures, affidavit, articles, photographs</b> ), this was considered sufficient to prove genuine use.
29/11/2010, <a href="#">B 1 477 670</a>	The opponent, which was active in the field of vehicle maintenance and the management of businesses associated with buying and selling vehicles, provided several <b>Annual Reports</b> giving a general overview of its overall commercial and financial activities. The OD found that these reports, by themselves, did not provide sufficient information on actual use for the majority of services claimed. However, in conjunction with <b>advertisements and publicity</b> displaying the mark in question for particular services, the OD concluded that the evidence as a whole provided sufficient indications as to the scope, nature, period and place of use for these services.

Case No	Comment
29/11/2010, <a href="#">R 919/2009-4</a> , GELITE / GEHOLIT	<p>The documents submitted by the appellant showed use of the trade mark for 'coating materials based on artificial resin (base, intermediate and top coatings) and industrial lacquers'. The attached <b>labels</b> showed use of the trade mark for various base, primer and top coatings. This information coincided with the attached <b>price lists</b>. The associated <b>technical information sheets</b> described the goods as corrosion coatings based on artificial resin, which are offered for sale in various colours. The attached <b>invoices</b> showed that these goods were supplied to various customers in Germany. Although the turnover figures stated in the written declaration in relation to the period from 2002 to 2007 did not expressly refer to Germany, it had to be concluded that they were obtained at least in part also in Germany. Consequently, the earlier mark was deemed to be used for the goods <i>lacquer, lacquer paints, varnishes, paints; dispersions and emulsions to coat and repair surfaces</i> because it was not possible to create any further subcategories for these goods.</p>

Case No	Comment
20/04/2010, <a href="#">R 878/2009-2</a> , SOLEA / Balea	<p>The solemn <b>declaration</b> refers to high sales figures (over EUR 100 million) for marked products from 2004 to 2006 and attaches internet extracts of <b>pictures</b> of the products sold during the relevant period (<i>soap, shampoo, deodorant (for feet and body), lotions, and cleaning items</i>). Although the internet extracts bear a copyright date of 2008, the credibility of what the declaration affirms is reinforced by the <b>judgment</b> of the State Court of Mannheim, a copy of which had been adduced previously by the opponent in order to demonstrate the enhanced distinctiveness of the earlier mark and which referred to the market share enjoyed by products bearing the opponent's mark for ladies' face care products (6.2 %), caring lotions (6.3 %), shower soaps and shampoos (6.1 %) and men's face care and shaving products (7.9 %). Moreover, the judgment states that, according to a <b>GfK study</b>, one fifth of German citizens purchase at least one BALEA product per annum. Reference is also made to <b>two further studies</b> that demonstrate that the brand is well known in Germany. Thus, proof of use for the mark has been demonstrated sufficiently for the products on which the opposition is based.</p>
25/03/2010, <a href="#">R 1752/2008-1</a> , ULUDAG / BURSA uludağ (fig.)	<p>The evidence provided to substantiate use of the earlier Danish trade mark appears to be sufficient. The Board is satisfied that the invoice provided shows place and time of use, as it proves the sale to a Danish company of 2 200 cartons of products within the relevant date. The <b>labels</b> submitted show use on soft drinks bearing the mark as represented on the registration certificate. As to the question whether proof consisting of <b>one single invoice</b> is sufficient in terms of extent of use, the content of that invoice, in the context of the remaining pieces of evidence, serves, in the Board's view, to conclude that the use made of the mark in Denmark is sufficient and genuine in connection with <i>aerated water, aerated water with fruit taste and soda water</i>.</p>

## 10.5.2 Genuine use not accepted

Case No	Comment
18/01/2011, <a href="#">T-382/08</a> , Vogue, EU:T:2011:9	The opponent submitted a <b>declaration</b> from the opponent's managing partner and 15 footwear manufacturers that footwear had been produced for the opponent under the trade mark VOGUE over a number of years, 35 <b>photographs</b> of VOGUE footwear models, photographs of stores and <b>670 invoices</b> issued to the opponent by footwear manufacturers. The Court held that the declarations did not provide sufficient evidence concerning the extent, place and time of use. The invoices concerned the sale of footwear <b>to</b> the opponent, not the sale of footwear to end consumers and, therefore, were not suitable for proving external use. Mere presumptions and suppositions ('highly unlikely', 'unreasonable to think', '... which probably explains the absence of invoices ...', 'reasonable to assume', etc.) cannot replace solid evidence. Therefore, genuine use was denied.
19/09/2007, 1359 C; confirmed 09/09/2008, <a href="#">R 1764/2007-4</a> , PAN AM II	The owner of the mark owned a US-based airline, operating solely in the US. The fact that flights could also be booked via internet from the European Union could not alter the fact that the actual services of transportation (Class 39) were rendered exclusively outside the relevant territory. Furthermore, the <b>lists submitted of passengers</b> with addresses in the European Union could not prove that the flights had actually been booked from Europe. Finally, the <b>website</b> was exclusively written in English, the prices were in US dollars and the relevant telephone and fax numbers were from within the US. Therefore, genuine use in the relevant territory was denied.

Case No	Comment
<p>04/05/2010, <a href="#">R 966/2009-2</a>, COAST / GREEN COAST (fig.) et al.</p>	<p>There are no special circumstances that might justify a finding that the <b>catalogues</b> submitted by the opponent, on their own or in combination with the <b>website</b> and <b>magazine extracts</b>, prove the extent of use of any of the earlier signs for any of the G&amp;S involved. Although the evidence submitted shows use of the earlier sign in connection with <i>clothing for men and women</i>, the opponent did not produce any evidence whatsoever indicating the commercial volume of the exploitation of this sign to show that such use was genuine.</p>
<p>08/06/2010, <a href="#">R 1076/2009-2</a>, EURO CERT (fig.)/ EUROCERT</p>	<p>It is well established in the case-law that a <b>declaration</b>, even if sworn or affirmed in accordance with the law under which it is rendered, must be corroborated by independent evidence. The declaration in this case, drawn up by an employee of the opponent's company, contains an outline of the nature of the relevant services, but only general statements concerning trade activities. It contains no detailed sales or advertising figures or other data that might show the extent and use of the mark. Furthermore, a mere <b>three invoices</b> with important financial data blanked out and a <b>list of clients</b> can hardly be considered corroborative evidence. Therefore, no genuine use of the earlier mark has been demonstrated.</p>

Case No	Comment
01/09/2010, <a href="#">R 1525/2009-4</a> , OFFICEMATE / OFFICEMATE (fig.)	The <b>spreadsheets</b> with turnover figures and the <b>Analysis and Review reports</b> concerning sales figures are documents drawn up by or commissioned by the appellant itself and, therefore, have less probative value. None of the evidence submitted contains any clear indication concerning the place of use of the earlier mark. The spreadsheets and the Analysis and Review Reports, which contain data compiled on the total value of estimated sales (in SEK) between the years 2003 to 2007, contain no information on where the sales took place. There is no reference to the territory of the European Union, where the earlier trade mark is registered. The invoices do not cover any sales of goods made by the appellant. Therefore, the evidence submitted is clearly insufficient to prove genuine use of the earlier mark.
12/12/2002, <a href="#">T-39/01</a> , HIWATT, EU:T:2002:316	A <b>catalogue</b> showing the mark on three different models of amplifiers (but not indicating place, time or extent), a <b>catalogue of the Frankfurt International trade fair</b> showing that a company called HIWATT Amplification International exhibited at that fair (but not indicating any use of the trade mark) and a copy of the 1997 HIWATT <b>Amplification Catalogue</b> showing the mark on different models of amplifiers (but not indicating place or extent of use) were not considered sufficient to prove genuine use, principally because of lack of extent of use.

---

**GUIDELINES FOR EXAMINATION OF  
EUROPEAN UNION TRADE MARKS**

**EUROPEAN UNION  
INTELLECTUAL PROPERTY OFFICE  
(EUIPO)**

***Part D***

***Cancellation***

---

## Table of Contents

<b>Section 1 Cancellation Proceedings.....</b>	<b>1410</b>
<b>Section 2 Substantive provisions.....</b>	<b>1444</b>



***GUIDELINES FOR EXAMINATION OF  
EUROPEAN UNION TRADE MARKS***

***EUROPEAN UNION  
INTELLECTUAL PROPERTY OFFICE  
(EUIPO)***

***Part D***

***Cancellation***

***Section 1***

***Cancellation Proceedings***

## Table of Contents

<b>1 Introduction — General Outline of Cancellation Proceedings.....</b>	<b>1413</b>
<b>2 Applications for Cancellation.....</b>	<b>1414</b>
<b>2.1 Persons entitled to file an application for cancellation.....</b>	<b>1414</b>
<b>2.2 Written applications.....</b>	<b>1415</b>
<b>2.3 Payment.....</b>	<b>1415</b>
<b>2.4 Languages and translation of the application for cancellation.....</b>	<b>1416</b>
2.4.1 Language of the proceedings.....	1416
2.4.2 Translation of the evidence required for admissibility.....	1417
<b>2.5 Admissibility check.....</b>	<b>1418</b>
2.5.1 Absolute admissibility requirements.....	1419
2.5.1.1 Contested mark is not yet registered.....	1419
2.5.1.2 Contested mark no longer exists.....	1419
2.5.1.3 <i>Res judicata</i> [Article 63(3) EUTMR].....	1419
2.5.1.4 Subsequent applications based on other rights that could have been invoked in support of the first application [Article 60(4) EUTMR].....	1421
2.5.1.5 Revocation on non-use: the mark has been registered for less than 5 years.....	1423
2.5.1.6 Application filed in the wrong language.....	1423
2.5.1.7 Identification of the contested mark.....	1423
2.5.1.8 Identification of the grounds.....	1423
2.5.1.9 Identification of the earlier marks/rights.....	1424
2.5.2 Relative admissibility requirements.....	1424
2.5.2.1 Identification of the applicant and/or representative.....	1425
2.5.2.2 Other particulars of the earlier marks/rights.....	1425
2.5.2.3 Application entered by a licensee or person entitled under European Union legislation or national law.....	1426
2.5.2.4 Extent of the application for cancellation.....	1426
2.5.2.5 Invitation to remedy deficiencies.....	1426
2.5.3 Optional indications.....	1427
2.5.3.1 Reasoned statement and supporting evidence.....	1427
2.5.3.2 Request for an earlier effective date of revocation.....	1427
<b>2.6 Notification of the admissibility of the application and the         commencement of the adversarial part of the proceedings.....</b>	<b>1428</b>
<b>3 Adversarial Stage.....</b>	<b>1429</b>
<b>3.1 Completion of the application.....</b>	<b>1429</b>

<b>3.2 Substantiation.....</b>	<b>1429</b>
3.2.1 Online Evidence.....	1431
3.2.1.1 Earlier trade mark applications and registrations, non-registered trade marks and other signs used in the course of trade, designations of origin and geographical indications (Article 60(1) EUTMR).....	1431
3.2.1.2 Industrial property rights (Article 60(2)(d) EUTMR).....	1431
<b>3.3 Translations and changes of language during cancellation proceedings.....</b>	<b>1432</b>
3.3.1 Change of language.....	1432
3.3.2 Translation of evidence of substantiation submitted by the applicant.....	1433
3.3.2.1 Evidence of filing, registration or renewal certificates or equivalent documents, any provisions of the applicable national law.....	1433
3.3.2.2 Other evidence.....	1433
3.3.3 Translation of observations submitted by the parties in the course of the proceedings.....	1434
3.3.4 Translation of evidence submitted by the EUTM proprietor in the course of the proceedings.....	1434
3.3.5 Translation of proof of use.....	1435
<b>3.4 Requests for proof of use.....</b>	<b>1435</b>
<b>4 Other Issues.....</b>	<b>1436</b>
<b>4.1 Continuation of proceedings.....</b>	<b>1436</b>
<b>4.2 Suspensions.....</b>	<b>1436</b>
<b>4.3 Surrenders, withdrawals and closure of the proceedings.....</b>	<b>1437</b>
4.3.1 Surrender of the contested mark.....	1437
4.3.1.1 Application for revocation pending.....	1437
4.3.1.2 Application for a declaration of invalidity pending.....	1438
4.3.1.3 The surrender predates the cancellation application.....	1439
4.3.1.4 Partial surrender does not affect the extent of the cancellation.....	1439
4.3.1.5 Surrender to be filed by way of a separate document.....	1439
4.3.2 Withdrawal of the application for cancellation.....	1439
4.3.3 Contested mark expires or is cancelled in parallel proceedings.....	1440
4.3.4 Decision on the apportionment of costs.....	1440
<b>4.4 Applications for revocation and for invalidity against the same EUTM</b>	<b>1441</b>
<b>4.5 Contested international registrations designating the EU.....</b>	<b>1441</b>
<b>4.6 Assignment.....</b>	<b>1442</b>
4.6.1 Admissibility of the request.....	1442
4.6.2 Priority of examination of the request for assignment.....	1443

## 1 Introduction — General Outline of Cancellation Proceedings

Proceedings in the Office concerning the revocation or invalidity of a registered European Union trade mark (EUTM) are grouped under the general heading of ‘cancellation proceedings’ and are managed in the first instance by the Cancellation Division. The basic rules regarding these proceedings are mainly contained in Articles [58 to 60](#) and Articles [62](#) and [64](#) EUTMR, and in Articles [12 to 20](#) EUTMDR.

Cancellation proceedings are initiated with the submission of an application for revocation or for a declaration of invalidity (the ‘application for cancellation’) against a registered EUTM. The EUTM proprietor is informed of this application, which can be accessed in the electronic file accessible on the Office’s website. An application for cancellation against an EUTM application that has not yet been registered or a trade mark that is no longer registered is not admissible.

Once the application for cancellation is received, the Office checks that the corresponding cancellation fee has been paid. If the fee has not been paid, the application is deemed not to have been filed.

Next, the Office verifies the admissibility of the application. There are two kinds of admissibility deficiencies.

1. **Absolute deficiencies:** deficiencies that cannot be remedied after the filing of the application. These deficiencies will automatically lead to the application being considered inadmissible.
2. **Relative deficiencies:** deficiencies that can be remedied after the filing of the application. The Office invites the cancellation applicant to remedy the deficiency in a non-extendable time limit of 2 months, failing which the application will be rejected as inadmissible.

Once the application is deemed filed, the Office will make an entry in the Register of the pending cancellation proceedings for the contested EUTM ([Article 111\(3\)\(n\) EUTMR](#)). This is to inform third parties about them. In parallel, the adversarial part of the proceedings is opened, the application for cancellation and other documents received are sent to the EUTM proprietor, and the parties are invited to submit observations (and, if applicable, proof of use).

There are usually two rounds of observations, after which the adversarial part is closed and the file is ready for a decision. Once the decision becomes final (i.e. if no appeal has been filed within the prescribed time limit, or when the appeal proceedings are closed), the Office will make the corresponding entry in the Register, in accordance with [Article 64\(6\) EUTMR](#).

In many respects, cancellation proceedings follow the same or analogous procedural rules as those established for opposition proceedings (e.g. friendly settlement, withdrawals of the application for cancellation, correction of mistakes and revocation, time limits, multiple cancellations, change of parties, *restitutio*). For all these matters, see the relevant sections of the Guidelines and in particular [Part C, Opposition](#).

[Section 1, Opposition Proceedings](#). This section of the Guidelines will therefore only focus on those aspects of the cancellation proceedings that are different from opposition proceedings.

## 2 Applications for Cancellation

### 2.1 Persons entitled to file an application for cancellation

Articles <a href="#">46(1)</a> and <a href="#">63(1)</a> EUTMR
--

Cancellation proceedings can never be initiated *ex officio* by the Office but only upon receipt of an application from a third party.

Applications for revocation or for invalidity based on absolute grounds (Articles [58](#) and [59](#) EUTMR) may be filed by:

1. any natural or legal person, or
2. any group or body set up for the purpose of representing the interests of manufacturers, producers, suppliers or services, traders or consumers, which under the terms of the law governing it has the capacity in its own name to sue and be sued.

As regards applications for revocation or for invalidity based on absolute grounds, the applicant does not need to demonstrate an interest in bringing proceedings (08/07/2008, [T-160/07](#), Color Edition, EU:T:2008:261, § 22-26, confirmed by 25/02/2010, [C-408/08 P](#), Color Edition, EU:C:2010:92, § 37-40). This is because, while relative grounds for invalidity protect the interests of proprietors of certain earlier rights, the absolute grounds for invalidity and for revocation aim to protect the general interest (including, in the case of revocations based on lack of use, the general interest in revoking the registration of trade marks that do not satisfy the use requirement) (30/05/2013, [T-396/11](#), Ultrafilter International, EU:T:2013:284, § 17-18).

In contrast, applications for invalidity based on relative grounds ([Article 60 EUTMR](#)) may only be filed by the persons mentioned in [Article 46\(1\) EUTMR](#) (in the case of applications based on [Article 60\(1\) EUTMR](#)) or by those entitled under European Union legislation or under the law of the Member State concerned to exercise the rights in question (in the case of applications based on [Article 60\(2\) EUTMR](#)).

Applications for revocation or invalidity based on Articles [81](#), [82](#), [91](#) or [92](#) EUTMR (in particular specific revocation and absolute grounds for collective marks and certification marks) follow the same rules, regarding entitlement, as applications for revocation or for invalidity based on absolute grounds ([Article 74\(3\) EUTMR](#)).

## 2.2 Written applications

### [Article 63\(2\) EUTMR](#)

An application for cancellation has to be filed in writing. It is not obligatory to use the forms provided by the Office, as long as all the admissibility requirements are met. However, the use of the official forms is highly recommended. Applications for cancellation may be submitted electronically.

## 2.3 Payment

Articles [63\(2\)](#) and [180\(3\)](#) EUTMR

Articles [15\(1\)](#) and [18\(2\)](#) EUTMDR

For general rules on payments, see the Guidelines, [Part A, General Rules, Section 3, Payment of Fees, Costs and Charges](#).

An application for cancellation is not deemed to have been filed until the fee has been paid. For this reason, before examining the admissibility of the application, the Office will first check that the fee has been received.

Where the Office finds that the fee has not been paid, it will invite the applicant to pay it within a given time limit. If the required fee is not paid within the time limit, the Office will inform the applicant that the application for cancellation is deemed not to have been filed. If the fee is paid, but after the specified time limit, it will be refunded to the applicant.

In cases where the fee is received after the expiry of the time limit specified by the Office but the applicant provides proof that, within the time limit, it duly gave an order to a banking establishment to transfer the amount of the payment in a Member State, [Article 180\(3\) EUTMR](#) will be applied, including the payment of a surcharge where applicable (see the Guidelines, [Part A, General Rules, Section 3, Payment of Fees, Costs and Charges](#)).

The filing date of an application for cancellation is not affected by the date of payment of the fee, since [Article 63\(2\) EUTMR](#) does not establish any consequence as regards the filing date of the application. When the fee is paid before the expiry of the time limit specified by [Article 15\(1\) EUTMDR](#), the application is deemed to have been filed and the filing date will be that on which the written statement was received by the Office.

As a general principle, the cancellation fee is an application fee due for the filing of the application regardless of the outcome of the proceedings. Therefore, it will not be refunded in cases of inadmissibility.

Neither will the cancellation fee be refunded in cases where the application for cancellation is withdrawn at any stage.

In this context, the only provisions that envisage the refund of the cancellation fee are [Article 15\(1\) EUTMDR](#), applicable only in cases where the application is deemed not to have been filed as a result of a late payment, and [Article 18\(2\) EUTMDR](#), which, applying [Article 9\(4\) EUTMDR](#) *mutatis mutandis*, envisages a refund of 50 % of the cancellation fee in the event of multiple applications, provided that the proceedings were suspended before the commencement of the adversarial part of the proceedings.

However, in the event of the withdrawal of the application for cancellation where the declaration of withdrawal reaches the Office on the same day as the original application, the fee will be refunded.

## 2.4 Languages and translation of the application for cancellation

### 2.4.1 Language of the proceedings

[Article 146\(5\) to \(7\) EUTMR](#)

[Article 15\(2\) and \(3\) EUTMDR](#)

The application for revocation or invalidity must be filed in one of the five languages of the Office. The rules regarding the language of proceedings are explained in detail in the Guidelines, [Part A, General Rules, Section 4, Language of Proceedings](#).

According to these rules, in cancellation proceedings there are cases where the applicant has a choice between two possible languages of proceedings (the first and second languages of the contested mark, both being languages of the Office), and cases where there is only one possible language of proceedings (when the first language is not one of the five languages of the Office, the language of the cancellation proceedings can only be the second language of the contested mark).

In cases where there is a choice, the language of proceedings will be that expressly indicated in the application for cancellation or, in the absence of an express indication, the language in which the application for cancellation was filed, in both cases provided that it is one of the possible languages of proceedings.

Where the wrong language of the proceedings has been chosen by the applicant, the EUTMR distinguishes between two different scenarios: where the incorrect language is a language of the Office, and where the incorrect language is one of the official languages of the European Union (but not of the Office). Depending on which of the above applies, there are different consequences for the applicant and time limits to respect when choosing the correct language of the proceedings and submitting the translation of the application for cancellation.

- If the application has been filed in a **language of the Office** that is not one of the possible languages of the proceedings, of its own motion the applicant has to submit a translation of the application into the first language, provided that it is a language of the Office, or into the second language. The translation must be produced **within**

**1 month of the filing date of the application for cancellation**, failing which the application will be rejected as inadmissible ([Article 146\(7\) EUTMR](#); [Article 15\(2\) and \(3\) EUTMDR](#)).

[Article 15\(4\) EUTMDR](#), regarding the invitation to the applicant to remedy deficiencies, does not refer to [Article 146\(7\) EUTMR](#); therefore, in these cases **the Office will not send a deficiency letter**, it will wait for 1 month from the filing date for the translation of the cancellation application to be submitted.

- If the language chosen by the applicant is **not a language of the Office**, the application will be rejected as inadmissible. [Article 146\(5\) EUTMR](#) applies, as it clearly specifies that the application for cancellation must be filed in a language of the Office. As it has not been filed in a language of the Office, the one-month period to remedy the deficiency of [Article 146\(7\) EUTMR](#) does not apply.

In the event that the language chosen by the applicant is not one of the possible languages of the proceedings, any correspondence issued by the Office in the cancellation proceedings will be in the first language of the contested mark, providing that it is a language of the Office, or in the second language if the first one is not one of the five languages of the Office.

Concerning the use of official forms, [Article 146\(6\) EUTMR](#) states that when the form provided by the Office is used, it may be used in any official language of the European Union, provided that it is completed in one of the languages of the Office as far as textual elements are concerned.

Where the applicant uses the official form in a language that cannot be the language of the proceedings, all textual elements are in the wrong language and a language has been chosen that cannot be the language of the proceedings, the above principles apply: where the incorrect language chosen is a language of the Office, the applicant has 1 month to submit a translation on its own motion; where the incorrect language chosen is not a language of the Office, the deficiency cannot be remedied and the application will be deemed inadmissible.

#### 2.4.2 Translation of the evidence required for admissibility

Articles <a href="#">15(4)</a> and <a href="#">16(2)</a> EUTMDR
---

Where evidence in support of the application is required to evaluate the admissibility of the case (e.g. the particulars of the earlier right on which the application is based), and this evidence is not in the language of the proceedings, or translated into that language, the Office will invite the applicant to remedy the deficiency pursuant to [Article 15\(4\) EUTMDR](#) (02/03/2007, [R 300/2006-4](#), ACTILON / ACTELION (fig.)). If the deficiency is not remedied, the application for cancellation will be rejected as totally or partially inadmissible (Articles [15\(4\)](#) and [16\(2\)](#) EUTMDR).



## 2.5 Admissibility check

[Article 58](#) and Articles [60\(4\)](#), [63\(3\)](#) and [66\(2\)](#) EUTMR

Articles [12](#), [15](#) and [16](#) EUTMDR

Once the Office has established that the corresponding fee has been duly paid, it checks the admissibility of the application.

In contrast to opposition proceedings, there is no cooling-off period and the applicant has until the closure of the adversarial part of the proceedings to submit evidence for substantiation. This means, in particular, that in the case of an application for invalidity based on relative grounds, the proof of the existence, validity and scope of protection of all the earlier rights and the evidence proving the applicant's entitlement to them have to be submitted. These documents should preferably be submitted together with the application.

The admissibility check covers both absolute and relative requirements.

**Absolute admissibility requirements** are the indications and elements that must be present in the application. They are described in detail in [paragraph 2.5.1](#). The applicant cannot remedy any failure to comply with an absolute admissibility requirement. If an absolute admissibility requirement is not met, the Office will consider the application inadmissible.

**Relative admissibility requirements** are the indications and elements that can be remedied by the applicant. They are described in detail in [paragraph 2.5.2](#). The applicant must remedy any relative admissibility deficiency notified by the Office within a non-extendable time limit of 2 months. If the deficiency is not remedied within the specified time limit, the Office will reject the application for cancellation as inadmissible.

Identification elements for absolute and relative admissibility are to be looked for not only in the application for cancellation, but also in its annexes (09/12/2020, [T-30/20](#), Promed, EU:T:2020:599, § 27-29). The same applies where the applicant provides evidence by referring to an online source pursuant to [Article 16\(1\)\(b\) or \(c\), second sentence, EUTMDR](#).

As long as an application for a declaration of invalidity based on relative grounds is found to be admissible for one earlier right, the parties will be notified accordingly and the proceedings will continue. The admissibility of any other earlier right will be examined later during the proceedings if necessary (e.g. if the earlier right that has been found admissible is not substantiated, see [paragraph 3.2](#), or where the application for invalidity cannot be fully upheld on the basis of that earlier right). The same applies to applications for invalidity based both on relative and absolute grounds.

Any decision to reject an application for cancellation as inadmissible will also be communicated to the EUTM proprietor ([Article 15\(5\) EUTMDR](#)) but can only be appealed by the applicant.

## 2.5.1 Absolute admissibility requirements

Where an absolute admissibility deficiency is found, the Office will invite the applicant to comment on the inadmissibility within 2 months. If, after hearing the applicant, the Office still maintains that there is an absolute admissibility deficiency, a decision will be issued rejecting the application for cancellation as inadmissible. This decision will be copied to the EUTM proprietor.

### 2.5.1.1 Contested mark is not yet registered

The application is filed against an EUTM that has not yet been registered. An application for cancellation can only be filed against a registered EUTM. A request directed against an application that has not yet been registered is premature (22/10/2007, [R 284/2007-4](#), VISION / VISION).

### 2.5.1.2 Contested mark no longer exists

The application is filed against an EUTM that no longer exists at the time of filing, since it has already been surrendered, has expired, or has been revoked or invalidated by a final decision.

### 2.5.1.3 *Res judicata* [Article 63(3) EUTMR]

<a href="#">Article 63(3) EUTMR</a>
-------------------------------------

Pursuant to [Article 63\(3\) EUTMR](#), an invalidity or revocation application is inadmissible where an application relating to the **same subject matter and cause of action, and involving the same parties**, has been adjudicated on its own merits, either by the Office or by an EUTM court as referred to in [Article 123 EUTMR](#), and a decision on that invalidity or revocation application has acquired the authority of a final decision.

#### a. Final decision on the substance

The defence of *res judicata* is effective only where there is a previous **final decision on the substance** in a counterclaim or cancellation application. The bar to admissibility does not apply, for instance, when a cancellation application was withdrawn before the corresponding decision became final or when the previous final decision declared the application inadmissible and did not adjudicate on the substance (15/09/2021, [T-207/20](#), PALLADIUM HOTELS & RESORTS (fig.) / Grand hotel palladium, EU:T:2021:587, § 42).

#### b. Same subject matter and cause of action

Advocate General Bobek pointed out that the terminology used for the individual requirements of *res judicata* may differ depending on the language version of the EUTM Regulation (EUTMR) (opinion of Advocate General Bobek of 13/04/2016, [C-226/15 P](#), English Pink / PINK LADY, EU:C:2016:250, footnote 5). In particular, the

English version of the EUTMR uses the term ‘subject matter’, whereas the French version uses ‘l’objet’ for capturing the same requirement. In his Opinion, the Advocate General interpreted ‘**cause of action**’ as referring to the **facts and legal provisions** that are relied on as the basis of the claim, and ‘**subject matter**’ as referring to both, the object of the action in the sense of the **result** the claimant is aiming at **and** the particular thing that is the **subject of the action** (Opinion of Advocate General Bobek of 13/04/2016, [C-226/15 P](#), English Pink / PINK LADY, EU:C:2016:250, footnote 5).

In view of the above and considering that the same ‘subject matter’ and ‘cause of action’ are both necessary requirements for applying *res judicata*, and that in certain circumstances they may overlap, the different scenarios involving these two elements will be presented together.

- *Res judicata* does not apply to an **application for invalidity** where a final decision was taken in previous invalidity proceedings where **different earlier rights** were invoked as a basis of the action. The identity of the cause of action with that of the prior case implies not only the same legal basis (e.g. reliance on the same legal provisions in support of the applications), but also the same facts and, in particular, the same earlier rights (see, by analogy, 17/11/2021, [T-538/20](#), Paños de limpieza, Ropa de mesa, EU:T:2021:793, § 19-20). The cause of action differs when the invalidity of the contested sign is sought in the proceedings before the Office in relation to an earlier right that was not relied on before (nor ruled upon by) the national court (see, by analogy, 17/11/2021, [T-538/20](#), Paños de limpieza, Ropa de mesa, EU:T:2021:793, § 21).
- *Res judicata* does not apply to an **application for invalidity** before the Office where the previous decision has been taken by a national EUTM court on **an application for a declaration of non-infringement**. The decisions of a national court ruling on an action for a declaration of non-infringement do not have the same subject matter as the invalidity proceedings before the Office (19/01/2022, [T-483/20](#), Shoes (3D), EU:T:2022:11, § 43-44).
- A prior decision by the Office in **opposition proceedings** between the same parties and relating to the same mark does not preclude a **later application for invalidity** based on the same earlier rights (14/10/2009, [T-140/08](#), TiMiKinderjoghurt, EU:T:2009:400, § 36, appeal to the Court dismissed; 22/11/2011, [T-275/10](#), Mpay24, EU:T:2011:683, § 15; 23/09/2014, [T-11/13](#), Mego, EU:T:2014:803, § 12), since the cause of action is different. However, a different outcome in invalidity proceedings is unlikely to arise except where one or more of the following conditions is fulfilled:
  - new facts are proven (e.g. proof of use or reputation of the earlier mark, not made available during opposition proceedings);
  - the manner in which key legal assessments are made has changed (e.g. with regard to the standards for assessing likelihood of confusion), for example, as a result of intervening judgments of the Court of Justice of the European Union.
- *Res judicata* does not apply to a **request for revocation** where the previous final decision refers to **another request for revocation submitted on a different date**. This is because the points in time at which the circumstances leading to the

revocation have to be established (lack of use, EUTM becoming generic or subject to misleading use) are different and the subject matter cannot therefore be deemed to be the same (31/01/2014, [7 333 C](#); 15/07/2015, [T-398/13](#), TVR ITALIA (fig.) / TVR et al., EU:T:2015:503, § 39).

- A prior decision in an **infringement action** before a national EUTM court does not constitute *res judicata* in **cancellation** or **proceedings concerning registration** (e.g. in examination or opposition proceedings) before the Office. A distinction must be made between, firstly, the subject matter of infringement proceedings and, secondly, actions for a declaration of invalidity and opposition proceedings. The possibility for the proprietor of an earlier EUTM to bring infringement proceedings against the proprietor of a later registered EUTM cannot render either an application for a declaration of invalidity or an opposition before the Office devoid of purpose (21/07/2016, [C-226/15 P](#), English Pink / PINK LADY, EU:C:2016:582, § 61). In addition, even when the contested national mark is identical to the contested EUTM, and the national proceedings and the proceedings before the Office involve the same parties, the subject matter of the two proceedings is not identical: the infringement action seeks, *inter alia*, the annulment of the national mark, whilst the proceedings before the Office concern the invalidity or the refusal of the registration of the EUTM (see, by analogy, 21/07/2016, [C-226/15 P](#), English Pink / PINK LADY, EU:C:2016:582, § 54).

#### c. Same parties

The application of *res judicata* requires that the parties to both proceedings (the one in question and the one that led to the previous final decision) are the same.

The notion of ‘same parties’ also covers successors in title and authorised licensees. In other words, *res judicata* applies if the party to the second action is the successor in title or an authorised licensee of the party to the first proceedings.

#### 2.5.1.4 Subsequent applications based on other rights that could have been invoked in support of the first application [Article 60(4) EUTMR]

##### [Article 60\(4\) EUTMR](#)

According to [Article 60\(4\) EUTMR](#), where the proprietor of an earlier right has previously made an application for a declaration of invalidity of an EUTM or has made a counterclaim for invalidity in infringement proceedings on the basis of rights in [Article 60\(1\) or \(2\) EUTMR](#) before an EUTM court, it may not submit a new application for a declaration of invalidity on the basis of other rights referred to in [Article 60\(1\) or \(2\) EUTMR](#) that it could have invoked in support of the first application.

This means that the Office will reject as inadmissible, in its entirety, any new application filed by the proprietor of an earlier right referred to in [Article 60\(1\) or \(2\) EUTMR](#) or by its successor in title, where such an application is based on other rights provided for in said Article(s), which could have been claimed in the first proceedings but were not.

This applies, irrespective of whether the new application is directed against the same and/or other goods or services than the ones initially contested.

The new application will be found inadmissible regardless of whether the first proceedings led to a final decision on the merits. In fact, [Article 60\(4\) EUTMR](#) applies even when the first request was withdrawn or declared inadmissible, or if it is still pending. The mere filing of the previous application is sufficient for applying this provision (15/09/2021, [T-207/20](#), PALLADIUM HOTELS & RESORTS (fig.) / Grand hotel palladium, EU:T:2021:587, § 43 and 45).

Such an approach follows from the general principles of legal certainty and legitimate expectations that, also, derive from an EUTM having been registered and being in the EUTM Register. These principles require that the application of the law to a specific situation be predictable and the interests of an EUTM proprietor protected against any subsequent 'attacks' from the same applicant (or its successor in title), which should not be allowed to circumvent the prohibition established by [Article 60\(4\) EUTMR](#) by submitting new application(s) for a declaration of invalidity on the basis of rights that were available to it at the moment of the original proceedings (15/09/2021, [T-207/20](#), PALLADIUM HOTELS & RESORTS (fig.) / Grand hotel palladium, EU:T:2021:587, § 44).

On the other hand, it follows from the wording of [Article 60\(4\) EUTMR](#) that, in principle, it cannot be applied when the new application for invalidity is based on **the same earlier right** that was invoked in the course of a previous action which was not adjudicated on the merits. Otherwise, there would be an overlap between the application of [Article 60\(4\) EUTMR](#) and [Article 63\(3\) EUTMR](#) (*res judicata*). Moreover, this would entail depriving [Article 63\(3\) EUTMR](#) of any useful effect (15/09/2021, [T-207/20](#), PALLADIUM HOTELS & RESORTS (fig.) / Grand hotel palladium, EU:T:2021:587, § 46). Therefore, [Article 60\(4\) EUTMR](#) will not apply to any subsequent application based on the same earlier right to the extent that its 'scope' (e.g. in terms of legal grounds and goods and services invoked) is the same or falls within the scope of the first action.

In addition, where an applicant requests the assignment of an EUTM pursuant to [Article 21\(2\)\(a\) EUTMR](#) in a procedure brought under [Article 60\(1\)\(b\) EUTMR](#), and, in a later application, requests a declaration that the same EUTM is invalid on the basis of other relative grounds, [Article 60\(4\) EUTMR](#) cannot be interpreted so as to bar the applicant from pursuing its claims under the other invalidity grounds should its primary request for assignment fail.

As regards counterclaims, [Article 128 EUTMR](#) imposes an obligation on EUTM courts or the interested party to notify the Office of the initiation of counterclaims for invalidity and their outcome. Where this is not done, an EUTM proprietor wishing to rely on the defence provided for by [Article 60\(4\) EUTMR](#) must submit, in order to support their claim, objective evidence that shows that proceedings entailing a counterclaim for invalidity of the EUTM is pending before an EUTM court such as a Declaration from the EUTM Court Registry (see also Part E, Register Operations, Section 6 Other entries in the register, [2 Application to Register the Filing of a Counterclaim Before an EUTM or a CD Court](#) on page 1646).

2.5.1.5 Revocation on non-use: the mark has been registered for less than 5 years

[Article 58 EUTMR](#)

An application for revocation based on non-use is filed against a trade mark that has not been registered for 5 years at the date of the application.

2.5.1.6 Application filed in the wrong language

[Article 146\(5\) EUTMR](#)

[Article 15\(2\) and \(3\) EUTMDR](#)

An application for cancellation is filed without having used the official form, which is neither in the correct language as established in [Article 146 EUTMR](#) nor translated into that language within 1 month of the filing of the application for cancellation. For more detailed information, see [paragraph 2.4](#) above.

2.5.1.7 Identification of the contested mark

[Article 12\(1\)\(a\) EUTMDR](#)

An application for cancellation must contain the EUTM registration number in respect of which revocation or a declaration of invalidity is sought and the name of its proprietor.

For more details on this admissibility deficiency, see the Guidelines, [Part C, Opposition, Section 1, Opposition Proceedings, paragraph 2.4.1.1](#), as the same explanations and reasoning apply to cancellation proceedings.

2.5.1.8 Identification of the grounds

[Article 12\(1\)\(b\) EUTMDR](#)

An application for cancellation must contain an indication of the grounds on which it is based, that is to say, an identification of the specific provisions of the EUTMR that justify the requested cancellation, as laid down in Articles [58](#), [59](#), [60](#), [81](#), [82](#), [91](#) or [92](#) EUTMR.

The applicant may limit the grounds on which the application was initially based but cannot enlarge the scope of the application by claiming any additional grounds during the course of the proceedings.

For more details on this admissibility deficiency, see the Guidelines, [Part C, Opposition, Section 1, Opposition Proceedings, paragraph 2.4.1.3](#), as the same explanations and reasoning apply to cancellation proceedings.

Revocation and invalidity grounds cannot be combined in a single application but must be subject to separate applications and entail the payment of separate fees. However, an application for revocation can be based on several revocation grounds, and an application for invalidity can be based on a combination of absolute and relative grounds.

#### 2.5.1.9 Identification of the earlier marks/rights

Where an application for invalidity is based on relative grounds ([Article 60 EUTMR](#)), the application must contain particulars of the right or rights on which the application is based.

[Article 60\(1\) EUTMR](#)

[Article 12\(2\)\(a\) EUTMDR](#)

Concerning the absolute identification requirements of earlier marks/rights invoked under [Article 60\(1\) EUTMR](#), see the Guidelines, [Part C, Opposition, Section 1, Opposition Proceedings, paragraph 2.4.1.2](#), as cancellation proceedings follow the same rules as oppositions, because [Article 12\(2\)\(a\) EUTMDR](#) applies the requirements of [Article 2\(2\)\(b\) EUTMDR](#) *mutatis mutandis*.

[Article 60\(2\) EUTMR](#)

[Article 12\(2\)\(b\) EUTMDR](#)

Concerning the absolute identification requirements of earlier rights invoked under [Article 60\(2\) EUTMR](#), such as:

- the right to a name;
- the right to personal portrayal;
- a copyright;
- an industrial property right.

The absolute identification requirements are:

- an indication of the nature of the earlier right;
- a representation of the earlier right;
- an indication of whether this right exists in the whole of the European Union or in one or more Member States, and if so, an indication of those Member States.

#### 2.5.2 Relative admissibility requirements

The relative admissibility requirements laid down by [Article 15\(4\) EUTMDR](#) are set out below.



### 2.5.2.1 Identification of the applicant and/or representative

#### [Article 12\(1\)\(c\) EUTMDR](#)

For information on the identification of the cancellation applicant, appointment of a professional representative, and the conditions under which appointment of a representative is mandatory see the Guidelines, [Part A, General rules, Section 5, Parties to the Proceedings and Professional representation](#), paragraphs [3](#) and [5](#).

Concerning multiple applicants, applications for invalidity based on relative grounds follow the same rules as oppositions (see the Guidelines, [Part C, Opposition, Section 1, Opposition Proceedings](#)). These rules are directly connected to the entitlement requirements of Articles [46\(1\)](#) and [63\(1\)](#) EUTMR (see above).

In contrast, in the case of applications for invalidity based on absolute grounds and for revocation there are no particular requirements regarding multiple applicants, except that they have to be clearly indicated in the application.

Please note that in all cases concerning multiple applicants, [Article 73 EUTMDR](#) and [Article 18\(2\) and \(3\) EUTMIR](#) will be applied (appointment of a common representative and fixing of costs).

### 2.5.2.2 Other particulars of the earlier marks/rights

#### [Article 12\(2\)\(c\) EUTMDR](#)

##### Dates

[Article 2\(2\)\(d\) and \(e\) EUTMDR](#) apply *mutatis mutandis*.

For more details on this admissibility deficiency, see the corresponding section in the Guidelines, [Part C, Opposition, Section 1, Opposition Proceedings, paragraph 2.4.2.1](#), as the same explanations and reasoning apply to cancellation proceedings.

##### Representation of earlier marks/signs

[Article 2\(2\)\(f\) EUTMDR](#) applies *mutatis mutandis*.

For more details on this admissibility deficiency, see the corresponding section in the Guidelines, [Part C, Opposition, Section 1, Opposition Proceedings, paragraph 2.4.2.2](#), as the same explanations and reasoning apply to cancellation proceedings.

##### Goods and services

[Article 2\(2\)\(g\) EUTMDR](#) applies *mutatis mutandis*.

For more details on this admissibility deficiency, see the corresponding section in the Guidelines, [Part C, Opposition, Section 1, Opposition Proceedings, paragraph 2.4.2.3](#), as the same explanations and reasoning apply to cancellation proceedings.



2.5.2.3 Application entered by a licensee or person entitled under European Union legislation or national law

[Article 12\(2\)\(d\) EUTMDR](#)

It is assumed that the applicant claims to be the owner of the earlier right, unless otherwise stated.

For more details on this admissibility deficiency, see the Guidelines, [Part C, Opposition, Section 1, Opposition Proceedings, paragraph 2.4.2.5](#), as the same explanations and reasoning apply to cancellation proceedings.

[Article 2\(2\)\(h\)\(iii\) EUTMDR](#) applies *mutatis mutandis*.

2.5.2.4 Extent of the application for cancellation

[Article 12\(1\)\(d\) EUTMDR](#)

The application may contain an indication of the goods and services against which the application is directed; in the absence of such an indication, the application will be considered to be directed against all of the goods and services of the contested registration.

If the applicant indicates that the application is only directed against part of the goods and services of the contested registration, it will have to list these goods/services clearly. If it does not do so, the application will be considered to be directed against all of the goods and services of the contested registration.

For more details, see the Guidelines, [Part C, Opposition, Section 1, Opposition Proceedings, 2.4.2.4 Extent of opposition](#), as the same explanations and reasoning apply to cancellation proceedings.

An applicant is entitled to limit the scope of its application by excluding subcategories of the goods and/or services for which the contested mark is registered (see, as regards applications for revocation, judgment of 09/12/2014, [T-307/13](#), ORIBAY, EU:T:2014:1038, § 25).

2.5.2.5 Invitation to remedy deficiencies

[Article 15\(4\) and \(5\) EUTMDR](#)

In accordance with [Article 15\(4\) EUTMDR](#), if the Office finds that an application for cancellation does not comply with [Article 12\(1\)\(c\), or \(2\)\(c\) or \(d\) EUTMDR](#), it will invite the applicant to remedy the deficiencies within a specific time limit. Please note that this only applies to deficiencies regarding admissibility requirements, and not to deficiencies regarding substantiation requirements, which the applicant must remedy of its own motion (see [paragraph 3.2](#) below).

If the deficiencies are not remedied before the expiry of the time limit, the Office will issue a decision rejecting the application as inadmissible. In cases where the application for cancellation is based on several grounds and/or earlier rights and the deficiencies only relate to some of them, the proceedings can continue in relation to the other grounds or earlier rights for which there are no admissibility deficiencies (partial admissibility).

In the context of [Article 15\(4\) EUTMDR](#), the fact that the applicant is invited to remedy a deficiency cannot lead to enlargement of the scope of the proceedings (earlier rights, goods and services, etc.) determined by the initial request.

Finally, [Article 15\(4\) EUTMDR](#) is only applicable to the list of relative admissibility requirements contained in [Article 12 EUTMDR](#). Deficiencies in relation to absolute admissibility requirements are not covered by [Article 15\(4\) EUTMDR](#) and cannot be remedied (i.e. they lead to the rejection of the application in question as inadmissible).

### 2.5.3 Optional indications

#### 2.5.3.1 Reasoned statement and supporting evidence

##### [Article 12\(4\) EUTMDR](#)

According to [Article 12\(4\) EUTMDR](#), an application for cancellation may also contain a reasoned statement on the grounds setting out the facts and arguments on which it is based and supporting evidence.

Both the reasoned statement on the grounds and the supporting evidence are optional at the stage of filing the application for revocation or for a declaration of invalidity. When they are necessary to substantiate the application they must be provided before the expiry of the substantiation period, which is the closure of the adversarial part of the revocation or invalidity proceedings ([Article 16\(1\) EUTMDR](#)). They concern the substance, not the admissibility of the application.

#### 2.5.3.2 Request for an earlier effective date of revocation

##### [Article 62\(1\) EUTMR](#)

An earlier effective date of revocation can be requested in the application for revocation (see also the Guidelines, [Part D, Cancellation, Section 2, Substantive Provisions, paragraph 1.3.1](#)). A later request to that effect must be denied as an inadmissible extension of the scope of the initial application.

## 2.6 Notification of the admissibility of the application and the commencement of the adversarial part of the proceedings

[Article 64\(1\) EUTMR](#)

[Article 17\(1\) EUTMDR](#)

Once the application for cancellation has been found admissible, the adversarial part of the proceedings is opened and the application for cancellation and other documents received are sent to the EUTM proprietor.

The notification of the application to the EUTM proprietor will contain an invitation to submit observations (and in the case of an application for revocation based on [Article 58\(1\)\(a\) EUTMR](#), an invitation to submit proof of genuine use — see [Article 19\(1\) EUTMDR](#)). In practice, the Office grants the EUTM proprietor 2 months for its first reply to the application.

The notification informing the parties that the application for cancellation has been found admissible constitutes a decision (see, by analogy to opposition proceedings, 18/10/2012, [C-402/11 P](#), Redtube, EU:C:2012:649, § 42-53). As it is a decision that does not terminate proceedings, it may only be appealed together with the final decision on the case ([Article 66\(2\) EUTMR](#)). Consequently, the Office is bound by this decision and may only revoke it if the requirements of [Article 103 EUTMR](#) for the revocation of decisions are met. This means that, for instance, if an admissibility deficiency is found after the application has been notified, it should first be determined whether the decision on admissibility can still be revoked. If so, the Office will issue the corresponding deficiency letter once the previous decision on admissibility has been revoked.

Revocation does not occur where the cause of inadmissibility arises **after** the initial admissibility check (e.g. when an applicant outside the EEA ceases to have a representative and does not appoint one, or when res judicata applies because a pertinent decision becomes final during the cancellation proceedings). In such cases the Office will again check the admissibility and issue the corresponding deficiency letter without revoking the previous admissibility decision (which did not contain any error at the time it was adopted).

## 3 Adversarial Stage

### 3.1 Completion of the application

[Article 64 EUTMR](#)

[Article 17\(2\) EUTMDR](#)

According to [Article 64\(1\) EUTMR](#), the Office may invite the parties to submit observations as often as it considers necessary. In practice, and in the interest of avoiding an unnecessary prolongation of the proceedings, the Office will usually grant two rounds of observations, usually ending with those of the EUTM proprietor (i.e. application for cancellation — EUTM proprietor's observations — applicant's observations — EUTM proprietor's observations).

However, additional rounds of observations may be granted in exceptional circumstances, in particular when additional relevant evidence, which could not have been submitted beforehand, is submitted in the last round. It is the Office's practice to give the parties a time limit of 2 months to submit their observations.

As regards applications for invalidity based on relative grounds, the EUTM proprietor may also file a request for proof of use of the earlier trade marks on which the application is based. If the request is admissible, the Office will invite the applicant to submit the proof ([Article 64\(2\) and \(3\) EUTMR](#) and [Article 19\(2\) EUTMDR](#)). For more guidance on requests for proof of use, see [paragraph 3.4](#) below.

Once the parties have submitted their observations and/or proof of use (if applicable) the adversarial part is closed and the file is ready for decision.

If at any stage of the proceedings one of the parties does not submit observations within the specified time limit, the Office will close the adversarial part and take a decision on the basis of the evidence before it ([Article 17\(2\) EUTMDR](#)).

As regards the rules on time limits, extensions, notification or change of parties in the course of proceedings, etc., see the Guidelines, [Part C, Opposition, Section 1, Opposition Proceedings](#), as the rules are applicable *mutatis mutandis*.

### 3.2 Substantiation

[Article 16](#) and [Article 17\(2\), \(3\) and \(4\) EUTMDR](#)

Unlike in the case of oppositions, there is no time limit for submitting a request for cancellation. This, in principle, allows cancellation applicants all the time they need to prepare their application and gather all the facts, evidence and arguments in support. Therefore, cancellation applicants should submit **all** the facts, evidence and arguments

in support **together with the application**. It is only once it is in receipt of all the facts, evidence and arguments in support of the application that the EUTM proprietor can prepare its defence and that a meaningful exchange of observations can ensue during the adversarial part of the proceedings.

Pursuant to [Article 16\(1\) EUTMDR](#), the cancellation applicant has until the closure of the adversarial part of the proceedings to present the facts, evidence and arguments in support of the application. The rationale of this provision is to grant more flexibility than in opposition proceedings to **complete** the facts, evidence and arguments in support of the application, particularly in response to the EUTM proprietor's challenges, given that cancellation is the last resort for challenging the validity of an EUTM (see also [paragraph 2.5.1.4](#) above). It is, moreover, in the cancellation applicant's best interest to submit all facts, evidence and arguments in support of the application (including any necessary translations) together with the application. Otherwise, the cancellation applicant runs the risk that, if the EUTM proprietor does not submit observations in reply, the adversarial part will be closed without the cancellation applicant having been given any further chance to submit anything further. This is because [Article 17\(2\) EUTMDR](#) states that, where the Office has invited a party to file observations within a specified period and it does not do so, the Office must close the adversarial part of the proceedings and base its ruling on the revocation or invalidity on the basis of the evidence before it.

In the case of an application for revocation pursuant to [Article 58\(1\)\(a\) EUTMR](#), the onus is on the EUTM proprietor to submit the proof of genuine use or of proper reasons for non-use; therefore, this is the only case where the applicant does not have to substantiate the application ([Article 19\(1\) EUTMDR](#)).

In the case of an application for revocation pursuant to [Article 58\(1\)\(b\) or \(c\) EUTMR](#) or an application for invalidity based on absolute grounds pursuant to [Article 59 EUTMR](#), the applicant must submit facts, arguments and evidence to support the grounds on which the application is based ([Article 16\(1\)\(a\) EUTMDR](#)).

In the case of an application for invalidity based on relative grounds pursuant to [Article 60\(1\) EUTMR](#), the applicant must prove the existence, validity and scope of protection of the earlier rights invoked, as well as submit evidence proving its entitlement to file the application for cancellation ([Article 16\(1\)\(b\) EUTMDR](#)). As regards substantiation requirements of earlier rights, see the Guidelines, [Part C, Opposition, Section 1, Opposition proceedings, paragraph 4.2](#), and the section on invalidity proceedings based on relative grounds in the Guidelines, [Part D, Cancellation, Section 2, Substantive provisions](#). If the earlier right that has been found admissible is not substantiated and there is another earlier right that is substantiated, the absolute admissibility requirements for that earlier right will be checked.

In the case of an application for invalidity based on relative grounds pursuant to [Article 60\(2\) EUTMR](#), the applicant must submit evidence of acquisition, continued existence and scope of protection of the earlier right, as well as evidence proving its entitlement to file the application for cancellation ([Article 16\(1\)\(c\) EUTMDR](#)).

Furthermore, for grounds invoked pursuant to [Article 60\(1\)\(c\) and \(d\) and Article 60\(2\) EUTMR](#), the applicant must specify the provisions of the applicable law it intends to rely on. If the law invoked is national law, it must also provide its contents by adducing official publications of the relevant provisions or jurisprudence. In all cases, the applicant must prove that it fulfils the conditions of acquisition and scope of protection of the applicable law invoked. See the Guidelines, [Part C, Opposition, Section 1, Opposition proceedings, paragraphs 4.2.4.3 and 4.2.4.4](#).

If the applicant does not submit the facts, arguments or evidence required to substantiate the application, the application will be rejected as unfounded ([Article 17\(3\) EUTMDR](#)).

### 3.2.1 Online Evidence

#### 3.2.1.1 Earlier trade mark applications and registrations, non-registered trade marks and other signs used in the course of trade, designations of origin and geographical indications (Article 60(1) EUTMR)

According to [Article 16\(1\)\(b\) EUTMDR](#), in the case of an application for invalidity based on the relative grounds for invalidity listed in [Article 60\(1\) EUTMR](#), the evidence required for the substantiation of the claim is the same as that required in opposition proceedings, as [Article 7\(3\) EUTMDR](#) applies *mutatis mutandis*. This also means, that the applicant in invalidity proceedings can rely on online substantiation for evidence of filing or registration of these earlier rights, and, where applicable, the relevant national law.

As the practice of informing the Office of the intention to rely on online evidence, and the identification of the online source is the same as for opposition proceedings, see the Guidelines, [Part C, Opposition, Section 1, Opposition Proceedings, paragraph 4.2](#), where the process of ‘formal declaration’ is explained, and later to each specific paragraph concerning each type of earlier right for the identification of the online sources.

#### 3.2.1.2 Industrial property rights (Article 60(2)(d) EUTMR)

In addition to the above, according to [Article 16\(1\)\(c\) EUTMDR](#), second sentence, where evidence concerning the filing or registration of an earlier **industrial property right** is to be submitted (under [Article 60\(2\)\(d\) EUTMR](#)), including where evidence concerning the contents of the relevant national law is required under this ground, and this evidence is accessible online from a source recognised by the Office, the applicant may rely on online substantiation.

Reliance on an industrial property right is specific to invalidity proceedings; however, applying the same reasoning and process set out in opposition proceedings, the applicant must formally declare its reliance on online substantiation before the expiry of the substantiation deadline. In addition, the Office will accept the identification of the official publications and/or national databases to the extent that they originate from the

government or official body of the respective Member State, and if they are publicly accessible and free of charge. For the identification of national law, the same requirements apply as in non-registered trade marks or other signs used in the course of trade (see the Guidelines, [Part C, Opposition, Section 1, Opposition Proceedings, paragraph 4.2.4.3](#)).

### **3.3 Translations and changes of language during cancellation proceedings**

#### **3.3.1 Change of language**

[Article 146\(8\) EUTMR](#)

[Article 13 EUTMDR](#)

The language of cancellation proceedings will in general be determined by the applicant in the cancellation application and has to comply with [Article 146 EUTMR](#). See [paragraph 2.4.1](#) above for more details about the choice of language for cancellation proceedings.

However, the parties to cancellation proceedings may also agree on a different official language of the European Union as the language of the proceedings ([Article 146\(8\) EUTMR](#)).

This agreement has to be communicated to the Office within 2 months of the notification of the application for cancellation to the EUTM proprietor. Where the application has not been filed in that language, the EUTM proprietor may request that the applicant submit a translation into that language. The translation request must be received by the Office within the same 2-month period. In this case, the applicant will be invited by the Office to submit the translation of the application into the language chosen by both parties within a time limit set for this purpose.

Where the translation is formally requested and it is not submitted or it is submitted late, or where the request to change the language is submitted late (after the expiry of the 2 months), the language of the proceedings will remain unchanged ([Article 13 EUTMDR](#)).



### 3.3.2 Translation of evidence of substantiation submitted by the applicant

[Article 16\(2\) EUTMDR](#)

[Article 24](#) and [Article 25\(1\) EUTMIR](#)

#### 3.3.2.1 Evidence of filing, registration or renewal certificates or equivalent documents, any provisions of the applicable national law

Where the application is based on the grounds of [Article 60\(1\) and \(2\) EUTMR](#), the evidence concerning the **filing, registration or renewal of earlier marks or rights**, or where applicable, the **contents of the relevant national law** must be submitted in the language of the proceedings, or should be translated into the language of the proceedings.

The translation is to be submitted by the applicant of its own motion within **1 month** of the filing of such evidence. This applies to all the evidence submitted by the applicant in the course of the proceedings in order to comply with the requirements of [Article 16\(1\)\(b\) and \(c\) EUTMDR](#), whether it is submitted together with the application or at a later stage. **The Office will not send a deficiency letter**, and it is up to the applicant to submit the translation of the evidence in support of the application of its own motion.

The requirement of translating the evidence of substantiation also relates to online evidence referred to by the applicant, where the language of the online evidence is not the same as the language of the proceedings. This follows from [Article 16\(2\) EUTMDR](#), which states that ‘evidence accessible online’ must also either be in the language of the proceedings, or be accompanied by a translation.

[Article 25\(1\) EUTMIR](#) requires that the translation reproduces the structure and contents of the original document. In the case of translations of online evidence of substantiation, the submission of the translation without the original will be accepted, as long as the document to which it refers is identified correctly.

Any document in support of the application that is not translated by the applicant into the language of proceedings within the time limit specified in [Article 16\(2\) EUTMDR](#) will be deemed not to have been received by the Office, and therefore will not be taken into account ([Article 25\(2\) EUTMIR](#)) (05/03/2012, [R 826/2010-4](#), MANUFACTURE PRIM 1949 (fig.), § 25).

#### 3.3.2.2 Other evidence

Any other evidence submitted by the applicant to substantiate the application, such as **evidence showing use in the course of trade or evidence of reputation**, will be subject to [Article 24 EUTMIR](#), namely it will only have to be translated into the language of the proceedings at the Office’s request within a period specified to that effect.



### 3.3.3 Translation of observations submitted by the parties in the course of the proceedings

[Article 146\(9\) EUTMR](#)

[Article 25\(2\)\(a\) EUTMIR](#)

In written proceedings before the Office, a party who submits observations in a **language of the Office** other than the language of the proceedings has to submit a translation of those observations in the language of the proceedings within **1 month** of the submission date ([Article 146\(9\) EUTMR](#)).

The Office **will not ask for the translations** and will proceed with the case. It is up to the party to submit the requisite translations.

If the translations are not submitted on the parties' initiative within the time limit of 1 month, the observations will be deemed not to have been received by the Office, and therefore will not be taken into account ([Article 25\(2\)\(a\) EUTMIR](#)).

Where a party submits observations in a **language of the European Union** that is **not** a language of the Office, the one-month time limit to translate the observations does not apply. The observations will be deemed not to have been received from the outset, and will not be taken into account.

### 3.3.4 Translation of evidence submitted by the EUTM proprietor in the course of the proceedings

[Article 24](#) and [Article 25\(2\)\(a\) EUTMIR](#)

The supporting documents submitted by the EUTM proprietor in the course of the proceedings (except for proof of use, see below) are subject to [Article 24 EUTMIR](#), and therefore may be submitted in any official language of the European Union.

In accordance with this provision, the EUTM proprietor is not automatically obliged to submit a translation, but **the Office may require it to do so within a time limit**. When exercising its discretion in this matter, the Office will take into account the nature of the evidence and the interests of the parties.

In cases where the Office does invite the EUTM proprietor to submit translations of the evidence, failure to do so within the specified time limit will mean that the untranslated documents will not be taken into account ([Article 25\(2\)\(a\) EUTMIR](#)).

### 3.3.5 Translation of proof of use

[Article 19 EUTMDR](#)

[Article 24 EUTMIR](#)

According to [Article 19\(1\) EUTMDR](#) (to which [Article 10\(6\) EUTMDR](#) applies *mutatis mutandis*) and to [Article 19\(2\) EUTMDR](#) (to which [Article 24 EUTMIR](#) applies directly), evidence of use may be submitted in any official language of the European Union.

Where the evidence of use is not in the language of the proceedings, the Office **may** require the party to submit a translation of the evidence into that language within a time limit specified by it. In exercising its discretion in this matter, the Office will take into account the nature of the evidence and the interests of the parties. In cases where the Office does invite the party to submit translations of the evidence, failure to do so within the specified time limit will mean that the untranslated documents will not be taken into account.

For further guidance on translation of evidence of use, see the Guidelines, [Part C, Opposition, Section 1, Opposition Proceedings, paragraph 5.6](#).

## 3.4 Requests for proof of use

[Article 19\(2\) EUTMDR](#)

The practice regarding proof of use requests according to [Article 64\(2\) or \(3\) EUTMR](#), where the EUTM proprietor wishes to request proof of use of the earlier trade marks on which the application for invalidity is based, has been aligned with opposition proceedings ([Article 10\(1\) EUTMDR](#)). In cancellation proceedings, a request for proof of use must be filed by the EUTM proprietor together with its first reply to the application, within the first time limit set to submit observations according to [Article 17\(1\) EUTMDR](#).

If a request for proof of use is submitted by the EUTM proprietor at a later stage of the proceedings, it will not be admissible.

In addition, according to [Article 19\(2\) EUTMDR](#), where the EUTM proprietor wishes to request proof of use, it must do so by way of a **separate document**. For a definition of a 'separate document' and further guidance on requests for proof of use, see the Guidelines, [Part C, Opposition, Section 1, Opposition proceedings, paragraph 5.1.4 Request made in a separate document](#) et al.

## 4 Other Issues

### 4.1 Continuation of proceedings

#### [Article 105 EUTMR](#)

According to [Article 105\(1\) EUTMR](#), any party to proceedings before the Office that has omitted to observe a time limit vis-à-vis the Office may, upon request, obtain the continuation of proceedings, provided that at the time the request is made the omitted act has been carried out. The request for continuation of proceedings will be admissible only if it is presented within 2 months of the expiry of the unobserved time limit and will not be deemed to have been filed until the corresponding fee has been paid.

This provision is applicable to all the proceedings before the Office. For more details, see the Guidelines, [Part A, General Rules, Section 1, Means of Communication, Time Limits](#).

In cancellation proceedings, continuation of proceedings can be requested for any of the different time limits within the cancellation proceedings (except for the time limit established in [Article 68\(1\) EUTMR](#) to file an appeal).

### 4.2 Suspensions

#### [Article 132 EUTMR](#)

#### [Article 71 EUTMDR](#)

In the matter of suspensions, see in general the Guidelines, [Part C, Opposition, Section 1, Opposition Proceedings](#) (taking into account, however, that in cancellation proceedings there is no cooling-off period). [Article 71 EUTMDR](#) applies.

The main particularity of cancellation proceedings in this matter concerns the specific rules on related actions before European Union trade mark courts. According to [Article 132\(2\) EUTMR](#), the Office, when hearing an application for cancellation will, unless there are special grounds for continuing the hearing, of its own motion after hearing the parties or at the request of one of the parties and after hearing the other parties, suspend the proceedings where the validity of the contested EUTM is already in issue on account of a counterclaim before a European Union trade mark court.

[Article 132\(2\) EUTMR](#) also states that if one of the parties to the proceedings before the European Union trade mark court so requests, the European Union trade mark court may, after hearing the other parties to these proceedings, suspend the proceedings. The Office will continue the proceedings pending before it in this case.

A request for suspension pursuant to [Article 132\(2\) EUTMR](#) should be supported by relevant evidence. Suspension requests are only considered relevant to the proceedings and might be granted under [Article 132\(2\) EUTMR](#) in cases where they refer to the contested EUTM and not where they refer to other EUTMs contested in parallel cancellation proceedings.

### 4.3 Surrenders, withdrawals and closure of the proceedings

[Article 57\(2\) EUTMR](#)

[Article 17\(5\), \(6\), \(7\) and \(8\) EUTMR](#)

#### 4.3.1 Surrender of the contested mark

In principle, the consequences in cancellation proceedings of a total surrender of the contested EUTM (or of a partial surrender of some of the goods and/or services against which the application for cancellation is directed) are similar to those of the withdrawal of an EUTM application in opposition proceedings.

However, unlike what occurs with the withdrawal of an EUTM application, the effects of the surrender of a registered EUTM are not the same as those of the decision on the substance terminating the proceedings in question. While the surrender of an EUTM only becomes effective on the date on which the surrender is registered, a decision cancelling the EUTM produces its effects from an earlier date, be it from the outset (in the case of invalidity) or from either the date on which the cancellation request was filed or which was fixed in the Office's decision at the request of one of the parties pursuant to [Article 62\(1\) EUTMR](#) (in the case of revocation). Consequently, despite the declaration of surrender of the contested EUTM, the applicant may still claim to have a legitimate interest in continuing the cancellation proceedings in order to obtain a decision on the substance (24/03/2011, [C-552/09 P](#), TiMiKinderjoghurt, EU:C:2011:177, § 42-43; 22/10/2010, [R 463/2009-4](#), MAGENTA (col.), § 25-27).

In practice, when there is a total or partial surrender of an EUTM that is subject to cancellation proceedings, and this surrender affects the scope of the proceedings, the Office will suspend the registration of the surrender and, in parallel, will notify the cancellation applicant of the surrender, inviting it to inform the Office whether it withdraws the application in view of the declared surrender. The consequence for the parties and the Office will depend not only on the reply of the applicant, but also on the type of cancellation proceedings in question, that is to say, whether the cancellation action is an application for revocation or whether it is an application for a declaration of invalidity.

##### 4.3.1.1 Application for revocation pending

If, in reply to the Office's letter, the applicant replies by withdrawing the application for revocation as a consequence of the surrender, the surrender will be recorded and the

proceedings will be closed without a decision on the substance. The application will be withdrawn.

If the applicant does not reply, the suspension of the surrender will be maintained and the cancellation proceedings will continue until there is a final decision on the substance. There is no need for the applicant to claim any legitimate interest.

After the decision on the substance has become final, the surrender will be recorded only for the goods and/or services for which the contested EUTM has not been revoked, if any.

#### 4.3.1.2 Application for a declaration of invalidity pending

If, in reply to the Office's letter, the applicant replies by withdrawing the application for a declaration of invalidity as a consequence of the surrender, the surrender will be recorded and the proceedings will be closed without a decision on the substance. The application will be withdrawn.

If the applicant does not reply, or does not claim any specific legitimate interest, the surrender will be recorded and the cancellation proceedings will continue for the remaining goods and/or services against which the cancellation is directed that were not removed by the partial surrender, if any. If all of the contested goods are removed by the surrender, the invalidity proceedings will be closed by a notification to that effect, without a decision on the substance. The application will be closed due to the surrender.

If the applicant replies and declares to have a **legitimate interest** in obtaining a decision on the substance, the Office will assess the request. A claim to a legitimate interest will only be accepted where the applicant proves why a decision on the substance of the declaration of invalidity is required, and why the surrender of the contested mark is not sufficient. Claims without any supporting evidence and without any explanation as to why the surrender of the mark is insufficient (as opposed to a declaration of invalidity) will be rejected. In addition, the legitimate interest must be real, direct and present. Requests based on possible future conflicts or presumed conflict arising from the conversion of the contested EUTM to a national registration will be rejected. As cases where a legitimate interest is claimed will mostly involve pending court proceedings, the party claiming this interest must lay out the relief sought in these court proceedings. The Cancellation Division will take a formal decision on the rejection of a claim of legitimate interest, maintaining the suspension of the surrender until the decision becomes final. Once the decision becomes final, the invalidity proceedings will be closed without a decision on the substance and the surrender will be recorded.

Only in cases where a legitimate interest is claimed and proven by the applicant, will the Office maintain the suspension of the surrender until a final decision is taken on the substance. In all other cases, the surrender will be recorded and the cancellation proceedings will continue for the remaining goods and/or services against which the cancellation is directed that were not removed by the partial surrender, if any. If all of the contested goods are removed by the surrender, the invalidity proceedings will be

closed without a decision on the substance. The application will be closed due to the surrender.

#### 4.3.1.3 The surrender predates the cancellation application

Where surrender is declared before the filing of the cancellation action, but had not yet been entered into the Register at the time of filing the application, the Office will take note of the surrender and enter it in the Register, irrespective of the filing of any later cancellation actions, including applications for revocation where the cancellation applicant asks for an earlier date to be fixed pursuant to [Article 62\(1\) EUTMR](#).

For the Office to suspend the entry in the Register of the surrender as explained above, it must have been declared subsequent to the submission of the cancellation application.

#### 4.3.1.4 Partial surrender does not affect the extent of the cancellation

Where a partial surrender does not affect any of the contested goods and/or services, the partial surrender will be registered as described in the Guidelines, [Part E, Register Operations, Section 1, Changes in a Registration](#), and the applicant in the cancellation proceedings will not be informed.

#### 4.3.1.5 Surrender to be filed by way of a separate document

According to [Article 17\(7\) EUTMDR](#), during the course of cancellation proceedings, where the EUTM proprietor wishes to surrender the contested mark, it must do so by way of a separate document.

When defining what a 'separate document' is, see the Guidelines, [Part C, Opposition, Section 1, Opposition Proceedings, paragraph 4.4.1](#), as the same principles apply.

#### 4.3.2 Withdrawal of the application for cancellation

The cancellation applicant can withdraw its application for cancellation at any time during the proceedings. The Office will inform the EUTM proprietor about the withdrawal and close the proceedings.

The **withdrawal of any pending appeal** (before the Boards of Appeal, the General Court or the Court of Justice) means that the **contested decision becomes final**. Consequently, the request for cancellation may no longer be withdrawn thereafter.

For further information concerning withdrawal of the application for cancellation after a decision by the Cancellation Division has been rendered, see, by analogy, the Guidelines, [Part C, Opposition, Section 1, Opposition Proceedings, paragraph 6.2.2.3](#).

#### 4.3.3 Contested mark expires or is cancelled in parallel proceedings

Similarly to the process explained above in [paragraph 4.3.1.2](#), where some (or all) of the contested goods and services are removed as a consequence of the final expiry of the contested EUTM, or as a consequence of a refusal in parallel revocation proceedings, the Office will inform the applicant and invite it to inform the Office whether it has a legitimate interest in obtaining a decision on the merits from an earlier date. The same applies as has already been explained in [paragraph 4.3.1.2](#), where a legitimate interest will have to be claimed and proven by the applicant.

If a legitimate interest is not claimed or proven, or where the contested mark was invalidated from the outset in the parallel invalidity proceedings, the proceedings will be closed without a decision on the substance.

The application will be closed due to the expiry or cancellation of the contested mark in the parallel case.

In the event that the expiry or the cancellation in parallel proceedings does not remove all of the contested goods, and a legitimate interest has not been claimed or proven, the proceedings will continue for the remaining goods and/or services against which the cancellation is directed that were not removed.

#### 4.3.4 Decision on the apportionment of costs

##### [Article 109\(4\) and \(6\) EUTMR](#)

The party that terminates the proceedings by withdrawing the application for revocation or the application for a declaration of invalidity, or by not renewing registration of the EUTM, or by surrendering the EUTM, will bear the fees and the costs incurred by the other party ([Article 109\(4\) EUTMR](#)), except in cases where the withdrawal is a consequence of a surrender (see paragraphs [4.3.1.1](#) and [4.3.1.2](#) above), in which case the costs will be borne by the EUTM proprietor.

In addition, the parties may indicate that a surrender or a withdrawal is a consequence of an agreement they have reached, and that a decision on costs is not necessary. The Office will not issue a decision on costs if such a request is received together with a request for surrender or withdrawal and is signed by both parties. Such a request can also be sent in two separate letters to the Office. In cases where no indication is given as to whether the parties have agreed on the costs, the Office will take a decision on costs immediately. The decision on costs already issued will not be revised by the Office in the event that the parties provide such information after the date of the decision. It is left to the parties to respect the agreement and not to 'execute' the Office's decision on costs.

For more details on the Office's practice of apportionment and fixing of costs in *inter partes* proceedings, see the Guidelines, [Part C, Opposition, Section 1, Opposition Proceedings, paragraphs 6.5 and 6.6](#).

[Article 15\(5\) EUTMDR](#)

Where an application for revocation or declaration of invalidity is rejected in its entirety as inadmissible pursuant to [Article 15\(2\), \(3\) or \(4\) EUTMDR](#), prior to the notification of the application under [Article 17\(1\) EUTMDR](#), no decision on costs will be taken.

#### 4.4 Applications for revocation and for invalidity against the same EUTM

If the same EUTM is subject to both revocation and invalidity proceedings, the Office has the power of discretion to decide in each case, taking into account the principles of economy of proceedings and administrative efficiency, whether one of the proceedings has to be suspended until the other has terminated, or in which order the proceedings should be decided.

If it is first decided that the EUTM is totally invalid (or partially, but for all the goods/services against which the revocation is directed), and once this decision becomes final, the parallel revocation proceedings will automatically be closed, as they no longer have any object. The costs are at the discretion of the Office ([Article 109\(5\) EUTMR](#)), which will usually conclude that each party has to bear its own costs.

However, taking into account the different effects of revocation (*ex nunc*) and of a declaration of invalidity (*ex tunc*), when it is first decided that the EUTM should be totally revoked (or partially, but for all the goods/services against which the invalidity is directed), the Office will inform the applicant of this decision when it becomes final and will invite it to submit its observations on the closure of the invalidity proceedings. If the applicant demonstrates a sufficient legal interest in obtaining a declaratory invalidity decision, the proceedings will continue.

#### 4.5 Contested international registrations designating the EU

[Article 190\(2\)](#) and [Article 198 EUTMR](#)

Cancellation proceedings can also be directed against international registrations (IRs) designating the European Union. The specific rules that are applicable in these cases (in particular in connection with the filing date and the relevant time limit for proof of use) can be found in the Guidelines, [Part M, International Marks](#).

A cancellation application against an IR may be filed after the date of the publication of the IR designating the European Union in the Official Bulletin of the Office (M.3.1. - International registrations with or without amendments since their publication under [Article 190\(1\) EUTMR](#)).

As regards WIPO representatives of the holders of contested IRs, the Office will as a general rule communicate with them, irrespective of the IR holder's location, when they comply with the criteria of [Article 120 EUTMR](#).



Where the WIPO representative of the IR holder does not comply with the criteria of [Article 120 EUTMR](#), the notification of the cancellation application will be sent directly to the IR holder, and a copy will be sent to its WIPO representative for information purposes.

The notification of the cancellation application will also invite the IR holder to appoint a professional representative in accordance with [Article 120 EUTMR](#) within 2 months of its receipt. In cases of obligatory representation ([Article 119\(2\) EUTMR](#)), the notification will indicate the consequences of not complying with this requirement (namely, that any communications sent by the IR holder in the course of the proceedings will not be taken into account).

## 4.6 Assignment

[Article 21\(1\) and \(2\)\(a\) EUTMR](#)

[Article 20 EUTMDR](#)

The cancellation applicant may request an assignment of the EUTM as an alternative to a declaration of invalidity if the conditions of [Article 21\(1\) and \(2\)\(a\) EUTMR](#) are fulfilled. In summary, the cancellation applicant will become the proprietor of the EUTM if the claim is successful. As the request is dealt with in the context of a procedure for a declaration of invalidity pursuant to [Article 60\(1\)\(b\) EUTMR](#), the rules of such proceedings apply.

Assignment will apply only in the case of an application for invalidity based on [Article 60\(1\)\(b\) EUTMR](#) in conjunction with [Article 8\(3\) EUTMR](#), namely where an EUTM is registered in the name of an unauthorised agent, without the proprietor's authorisation. For these cases, the applicant in the invalidity proceedings may request **either** the invalidity of the mark (pursuant to [Article 60\(1\)\(b\) EUTMR](#)), **or** the assignment of the EUTM in the applicant's favour (pursuant to [Article 21 EUTMR](#) and [Article 20\(1\) EUTMDR](#)).

If the contested EUTM survives the action in part, either because the action was directed against part of the goods and services only or was partly unsuccessful, the mark will be split. The part for the successful applicant will be given a new trade mark registration number with the new proprietor, its representative from the invalidity proceedings and the list of goods and services for which the claim was successful. All other particulars of the mark remain as in the original mark.

### 4.6.1 Admissibility of the request

When filing an application for invalidity based on [Article 60\(1\)\(b\) EUTMR](#) in conjunction with [Article 8\(3\) EUTMR](#), in the application form the cancellation applicant must indicate the relief sought, which can be:

1. a declaration of invalidity; **or**

2. assignment pursuant to [Article 21\(2\)\(a\) EUTMR](#).

A request for assignment cannot be invoked cumulatively with a request for invalidating the EUTM under the same ground of [Article 60\(1\)\(b\) EUTMR](#). If the cancellation applicant does so erroneously, the Office will invite the applicant to choose one type of relief or the other. The party will be informed that in the absence of a reply, the Office will assume that the cancellation applicant wishes to rely on the relief of assignment (and not a declaration of invalidity).

4.6.2 Priority of examination of the request for assignment

If the applicant invokes [Article 60\(1\)\(b\) EUTMR](#) with relief seeking the assignment of the contested EUTM and [Article 59\(1\)\(a\) EUTMR](#) (registration contrary to the provisions of [Article 7 EUTMR](#)), the Office will first examine the absolute grounds for invalidity due to the public interest underlying that provision. If an absolute ground for invalidity applies, the Office cannot grant the assignment of the EUTM.

If the applicant invokes [Article 60\(1\)\(b\) EUTMR](#) with relief seeking the assignment of the contested EUTM and any other ground for invalidity (i.e. bad faith pursuant to [Article 59\(1\)\(b\) EUTMR](#), or any other relative ground pursuant to [Article 60\(1\)\(a\), \(c\), \(d\)](#), or [Article 60\(2\) EUTMR](#)), the Office will first examine the request for assignment. The alternative relief stipulated in [Article 21\(2\)\(a\) EUTMR](#) would lose its useful effect if the Office had the discretion to invalidate the EUTM, contrary to the express intention of the applicant. In addition, while the winning applicant's legal situation would be substantially different if, instead of assignment, the EUTM were invalidated, the losing proprietor's legal situation would be the same whatever the outcome.

For more details on assignment in invalidity proceedings, see the Guidelines, [Part D, Cancellation, Section 2, Substantive Provisions](#).

***GUIDELINES FOR EXAMINATION OF  
EUROPEAN UNION TRADE MARKS***

***EUROPEAN UNION  
INTELLECTUAL PROPERTY OFFICE  
(EUIPO)***

***Part D***

***Cancellation***

***Section 2***

***Substantive provisions***

## Table of Contents

<b>1 General Remarks.....</b>	<b>1448</b>
<b>1.1 The grounds for cancellation.....</b>	<b>1448</b>
<b>1.2 <i>Inter partes</i> proceedings.....</b>	<b>1448</b>
<b>1.3 The consequences of revocation and invalidity.....</b>	<b>1449</b>
1.3.1 The legal effect of revocation.....	1449
1.3.2 The legal effect of invalidity.....	1449
1.3.3 The legal effect of a request for assignment of an EUTM.....	1449
<b>2 Revocation.....</b>	<b>1450</b>
<b>2.1 Introduction.....</b>	<b>1450</b>
<b>2.2 Non-use of the EUTM — Article 58(1)(a) EUTMR.....</b>	<b>1450</b>
2.2.1 Burden of proof.....	1451
2.2.2 Genuine use.....	1451
2.2.3 Period of time to be considered.....	1452
2.2.4 Proper reasons for non-use.....	1453
<b>2.3 EUTM becoming a common name (generic term) — Article 58(1)(b) EUTMR.....</b>	<b>1453</b>
2.3.1 Burden of proof.....	1453
2.3.2 Point in time to be considered.....	1454
2.3.3 Relevant public.....	1454
2.3.4 Common name.....	1454
2.3.5 Defence for the proprietor.....	1455
<b>2.4 EUTM becoming misleading — Article 58(1)(c) EUTMR.....</b>	<b>1455</b>
2.4.1 Burden of proof.....	1455
2.4.2 Point in time to be considered.....	1456
2.4.3 Standards to be applied.....	1456
2.4.4 Examples.....	1456
<b>2.5 Additional grounds for revocation of EU collective marks (Article 81 EUTMR).....</b>	<b>1457</b>
<b>2.6 Additional grounds for revocation of EU certification marks (Article 91 EUTMR).....</b>	<b>1457</b>
<b>3 Absolute Grounds for Invalidity.....</b>	<b>1458</b>
<b>3.1 EUTM registered contrary to Article 7 EUTMR — Article 59(1)(a) EUTMR.....</b>	<b>1458</b>
3.1.1 Burden of proof.....	1458

3.1.2 Points in time to be considered.....	1458
3.1.3 Standards to be applied.....	1459
<b>3.2 Defence against a claim of lack of distinctiveness.....</b>	<b>1459</b>
<b>3.3 Bad faith — Article 59(1)(b) EUTMR.....</b>	<b>1460</b>
3.3.1 Relevant point in time.....	1460
3.3.2 Concept of bad faith.....	1460
3.3.2.1 Factors likely to indicate the existence of bad faith.....	1461
3.3.2.2 Factors unlikely to indicate the existence of bad faith.....	1465
3.3.3 Proof of bad faith.....	1465
3.3.4 Relation to other EUTMR provisions.....	1466
3.3.5 Extent of invalidity.....	1466
<b>3.4 Absolute grounds for invalidity for EU collective marks.....</b>	<b>1466</b>
<b>3.5 Absolute grounds for invalidity for EU certification marks.....</b>	<b>1467</b>
<b>4 Relative Grounds for Invalidity.....</b>	<b>1467</b>
<b>4.1 Introduction.....</b>	<b>1467</b>
<b>4.2 Grounds under Article 60(1) EUTMR.....</b>	<b>1468</b>
4.2.1 Standards to be applied.....	1468
4.2.2 Points in time to be considered.....	1468
4.2.2.1 For the assessment of enhanced distinctiveness or reputation.....	1468
4.2.2.2 Application based on Article 60(1)(c) EUTMR in conjunction with Article 8(4) EUTMR.....	1469
<b>4.3 Grounds under Article 60(2) EUTMR — other earlier rights.....</b>	<b>1469</b>
4.3.1 A right to a name/right of personal portrayal.....	1469
4.3.2 Copyright.....	1472
4.3.3 Other industrial property rights.....	1475
<b>4.4 Non-use of the earlier mark.....</b>	<b>1475</b>
<b>4.5 Defences against an invalidity application based on relative grounds. 1477</b>	
4.5.1 Consent to registration.....	1477
4.5.1.1 Examples rejecting the claim of consent to registration.....	1477
4.5.1.2 Examples accepting the claim of consent to registration.....	1478
4.5.2 Acquiescence.....	1479
4.5.2.1 Examples rejecting the acquiescence claim.....	1480
4.5.2.2 Examples (partially) accepting the acquiescence claim.....	1483
<b>Annex 1 Grounds for Invalidity: Temporal Scope of Application Following the Entry into Force of Regulation (EU) 2015/2424 on 23 March 2016.....</b>	<b>1485</b>

<b>1 Absolute Grounds for Invalidity</b> .....	<b>1485</b>
1.1 Grounds for invalidity that applied before 23 March 2016 by virtue of EU regulations other than the CTMR.....	1485
1.2 Grounds for invalidity that were not envisaged by EU law before the entry into force of Regulation (EU) 2015/2424 on 23 March 2016.....	1486
<b>2 Relative Grounds for Invalidity, Namely Article 60(1)(d) EUTMR in Conjunction with Article 8(6) EUTMR and the Relationship with Article 60(1)(c) EUTMR in Conjunction with Article 8(4) EUTMR</b> .....	<b>1486</b>

## 1 General Remarks

### 1.1 The grounds for cancellation

Pursuant to [Article 63\(1\) EUTMR](#), cancellation proceedings comprise applications for revocation and for declarations of invalidity.

The grounds for revocation are established in [Article 58 EUTMR](#).

The grounds for invalidity are established in [Article 59 EUTMR](#) (absolute grounds), and [Article 60 EUTMR](#) (relative grounds). For the temporal scope of application of the grounds for invalidity following the entry into force of Regulation (EU) [2015/2424](#), see Annex 1 below.

In addition to those general grounds, specific grounds can be invoked by a cancellation applicant in support of its request to cancel a collective mark as per [Article 81 EUTMR](#) (grounds for revocation) and [Article 82 EUTMR](#) (grounds for invalidity), or a certification mark, as per [Article 91 EUTMR](#) (grounds for revocation) and [Article 92 EUTMR](#) (grounds for invalidity) (see paragraphs [2.5](#) and [2.6](#), [3.4](#) and [3.5](#) below).

Where an EUTM is registered in the name of the proprietor's agent or representative without its authorisation, the proprietor may request that the Office assigns the EUTM in his or her favour. This is as an alternative relief in a procedure for a declaration of invalidity under [Article 60\(1\)\(b\) EUTMR](#) in conjunction with [Article 8\(3\) EUTMR](#). For further details, see paragraph [1.3.3](#) below and the Guidelines, [Part D, Cancellation, Section 1, Cancellation Proceedings](#).

The EUTMDR in Articles [12 to 19](#), lays down the relevant provisions concerning applications for revocation and for a declaration of invalidity, including the languages of such proceedings, admissibility, substantiation and examination of the merits, etc.

### 1.2 *Inter partes* proceedings

Cancellation proceedings are never initiated by the Office itself. The initiative lies with the applicant for cancellation, even in cases based on absolute grounds for invalidity.

[Article 63\(1\) EUTMR](#) establishes the conditions that the applicant must fulfil in order to have *locus standi* for filing an application for revocation or for a declaration of invalidity. For further details, please see the Guidelines, [Part D, Cancellation, Section 1, Cancellation Proceedings, paragraphs 2.1](#) and [4.1](#).

## 1.3 The consequences of revocation and invalidity

### 1.3.1 The legal effect of revocation

According to [Article 62\(1\) EUTMR](#), in the event of **revocation**, and to the extent that the rights of the proprietor have been revoked, the EUTM will be deemed not to have the effects specified in the EUTMR as from the date of the application for revocation.

An earlier date on which one of the grounds for revocation occurred may be fixed by the Office if this is requested by one of the parties, provided that the requesting party shows a legitimate legal interest in this respect. On the basis of information available in the relevant case file, it must be possible to determine the earlier date accurately. The earlier date should, in any event, be set after the 5-year ‘grace period’ that the EUTM proprietor has after the registration of an EUTM pursuant to [Article 18 EUTMR](#) (28/07/2010, 3 349 C, Alpatrad, confirmed by 08/10/2012, [R 444/2011-1](#), ALPHATRAD (fig.), § 48-50; 16/01/2014, [T-538/12](#), Alpatrad, EU:T:2014:9).

Where the application for revocation was preceded by a counterclaim for revocation pursuant to [Article 128 EUTMR](#) between the same parties and ‘deferred’ by a court pursuant to [Article 128\(7\) EUTMR](#), the effective date of revocation will be the date of the counterclaim, regardless of whether that date was explicitly requested in the application for revocation before the Office (see at [paragraph 2.2.3](#) below). This is without prejudice to any possible request of an earlier effective date for revocation in the initial counterclaim (in which case a legitimate interest has to be proven).

For Office practice regarding surrenders when there is a revocation case pending, see the Guidelines, [Part D, Cancellation, Section 1, Cancellation Proceedings, paragraph 4.3](#).

### 1.3.2 The legal effect of invalidity

According to [Article 62\(2\) EUTMR](#), in the event of a **declaration of invalidity**, the EUTM will be deemed not to have had, as from the outset, the effects specified in the EUTMR.

For Office practice regarding surrenders when there is an invalidity case pending, see the Guidelines, [Part D, Cancellation, Section 1, Cancellation Proceedings, paragraph 4.3](#).

### 1.3.3 The legal effect of a request for assignment of an EUTM

Pursuant to Articles [21\(2\)\(a\)](#) and [163\(1\)\(b\)](#) EUTMR, where the EUTM proprietor seeks a declaration of invalidity under [Article 60\(1\)\(b\) EUTMR](#) in conjunction with [Article 8\(3\) EUTMR](#), the proprietor may request, as an alternative to invalidating the mark, its assignment in his or her favour if it was registered in the name of its agent or representative without its authorisation. Such a request for assignment is not a separate ground for action, but merely **alternative relief**. If the claim is successful, the



applicant will become the proprietor of the EUTM with retroactive effect to the date of filing, or where applicable, priority, of the contested EUTM. Such an alternative remedy is not available in other grounds for invalidity.

## 2 Revocation

### 2.1 Introduction

According to [Article 58\(1\) EUTMR](#), there are three grounds for revocation.

- The EUTM has not been put to genuine use during a continuous period of 5 years.
- The EUTM has become generic due to acts/inactivity of its proprietor.
- The EUTM has become misleading due to the use made by its proprietor or with its consent.

These grounds are examined in further detail in the paragraphs below. According to [Article 58\(2\) EUTMR](#), where the grounds for revocation exist for only some of the registered goods and services, the EUTM proprietor's rights will be revoked only for those goods and services.

In addition to these grounds, [Article 81 EUTMR](#) lists three further specific grounds on which the rights of the proprietor of an **EU collective mark** may be revoked. Specific, additional grounds for revocation of **EU certification marks** are listed in [Article 91 EUTMR](#).

### 2.2 Non-use of the EUTM — Article 58(1)(a) EUTMR

According to [Article 58\(1\)\(a\) EUTMR](#), if within a continuous period of 5 years after the EUTM has been registered and before the filing of the application for cancellation the EUTM has not been put to genuine use, within the meaning of [Article 18 EUTMR](#), then the EUTM must be revoked unless there are proper reasons for non-use.

Pursuant to [Article 58\(2\) EUTMR](#), if the EUTM has been used for only some of the goods and services for which it is registered, the revocation will be limited to the goods and services not used.

As regards **procedural aspects** of the submission of the evidence (time limits for submitting evidence, additional rounds for observations and submission of additional relevant evidence, translation of evidence, etc.), see the Guidelines, [Part D, Cancellation, Section 1, Cancellation Proceedings](#).

The practice rules applicable to the **substantive assessment** of proof of use of earlier rights in opposition proceedings are applicable to the assessment of requests for revocation based on non-use (see the Guidelines, [Part C, Opposition, Section 7, Proof of use](#)). However, there are a number of particularities to be taken into account in the context of revocation proceedings, which will be examined below.

### 2.2.1 Burden of proof

Pursuant to [Article 19\(1\) EUTMDR](#), the burden of proof lies with the EUTM proprietor.

It is the proprietor of the mark at issue that is best placed to adduce evidence to support the assertion that its mark has been put to genuine use (22/10/2020, [C-720/18 and C-721/18](#), Ferrari, EU:C:2020:854, § 78 and 81-82 and the case-law cited therein). On the other hand, the revocation applicant is not required to make any substantiated submissions to support its application that go beyond the claim that the mark has not been put to genuine use by its proprietor (e.g. to carry out market research concerning the possible use of that mark by its proprietor) (10/03/2022, [C-183/21](#), Maxxus, EU:C:2022:174, § 38 and 46).

The role of the Office is to assess the evidence put before it in the light of the parties' submissions. The Office cannot determine *ex officio* genuine use of marks subject to a revocation action. It has no role in collecting evidence itself. Even proprietors of purportedly well-known marks must submit evidence to prove genuine use of their marks.

### 2.2.2 Genuine use

According to [Article 19\(1\) EUTMDR](#) in conjunction with [Article 10\(3\) EUTMDR](#), the indications and evidence for submitting proof of use must consist of indications concerning the place, time, extent and nature of use of the contested trade mark for the goods and services for which it is registered.

As indicated above, the assessment of genuine use (including place, time, extent and nature of use) is the same in cancellation proceedings and in opposition proceedings. The detailed considerations in the Guidelines, [Part C, Opposition, Section 7, Proof of use](#) should be followed.

Lack of genuine use for some of the contested goods or services in a revocation case implies the revocation of the registered EUTM for those goods or services. Consequently, great care must be taken when assessing the evidence of use in revocation proceedings regarding **the use for the registered (and contested) goods or services**.

Case No	Comment
---------	---------

<p>02/10/2012,  <a href="#">R 1857/2011-4</a>  AQUOS</p>	<p>The EUTM was registered for <i>angling articles</i>; <i>angling equipment</i>; <i>angling accessories</i> in Class 28. The Board confirmed the Cancellation Division decision and maintained the EUTM for <i>fishing rods</i> and the unchallenged <i>fishing lines</i> in Class 28. The Board concurred with the Cancellation Division that the evidence submitted in order to prove use of the contested EUTM showed genuine use for 'fishing rods' and that these goods are sufficiently distinct from the broad categories of <i>angling articles</i> and <i>angling equipment</i> to form coherent subcategories. This finding was not challenged by the appellant.</p>
--	---

### 2.2.3 Period of time to be considered

Pursuant to [Article 58\(1\)\(a\) EUTMR](#), the EUTM becomes susceptible to revocation if it has not been put to genuine use within a continuous period of 5 years. However, no person may claim that the proprietor's rights in an EUTM should be revoked where, during the interval between expiry of the 5-year period and filing of the application, genuine use of the trade mark has started or resumed. Further, according to [Article 62\(1\) EUTMR](#), if the request for revocation is granted, the effective date of revocation is the date of the application for revocation.

It follows from those provisions that the proprietor must prove genuine use of the contested EUTM within the **5-year period preceding the date of the application for revocation** (17/12/2020, [C-607/19](#), HUSQVARNA, EU:C:2020:1044, § 35-41).

For example, if the EUTM was registered on 01/01/2011, it became susceptible to revocation on 02/01/2016. If the application for revocation was filed on 15/09/2016, the EUTM proprietor would have to prove genuine use of its mark within the period from 15/09/2011 to 14/09/2016.

Even in the case where an EUTM has not been put to genuine use in any continuous 5-year period after its registration, it cannot be revoked if genuine use commenced or was resumed before the filing of the application for revocation. However, where this period is no more than 3 months **and** it can be established that the proprietor started or resumed genuine use of the mark in view of threatening revocation, evidence of this use cannot be taken into account, and the EUTM will have to be revoked. The burden of proof is on the applicant for revocation to prove that it made the EUTM proprietor **aware of its intention** to file an application for revocation.

In no case can evidence of genuine use **preceding** a continuous 5-year period of non-use be taken into account, regardless of how long-standing that use may have been.

If an **earlier effective date of revocation** is requested pursuant to [Article 62\(1\) EUTMR](#), this can only be granted — subject to the cancellation applicant proving a legitimate interest (see [paragraph 1.3.1](#) above) — if no genuine use of the contested mark has been proved **both** within the 5-year period preceding the date of application for revocation **and** within the 5-year period preceding the earlier effective date requested. This follows from the wording of [Article 62\(1\), second sentence, EUTMR](#), which provides that an earlier effective date for revocation may be set if the ground for revocation ‘occurred’ on that date. However, even if such an earlier effective date is requested, the EUTM proprietor’s prime interest is to prove genuine use of the contested mark within the 5-year period immediately preceding the date of application for revocation. If genuine use of the contested EUTM within this period is proven, the contested mark cannot be revoked at all. Proof of genuine use of the contested mark within the 5-year period preceding the requested earlier effective date may become relevant only if there is no proof of genuine use of the contested mark within the 5-year period immediately preceding the date of application for revocation.

If the application for revocation was preceded by a counterclaim for revocation pursuant to [Article 128 EUTMR](#) between the same parties and ‘deferred’ by a court pursuant to [Article 128\(7\) EUTMR](#), the time period for which genuine use must be proven is the 5 years preceding the date of the **counterclaim** (17/01/2018, [T-68/16](#), DEVICE OF A CROSS ON A SPORT SHOE SIDE (fig.), EU:T:2018:7, § 55-56).

#### 2.2.4 Proper reasons for non-use

The detailed considerations in the Guidelines, [Part C, Opposition, Section 7, Proof of use](#) and in particular [paragraph 9](#) should be followed.

### 2.3 EUTM becoming a common name (generic term) — Article 58(1)(b) EUTMR

An EUTM will be revoked if, as a result of action or inaction on the part of the proprietor, it has become the common name in the trade for a product or service for which it was registered.

#### 2.3.1 Burden of proof

The burden is on the applicant for revocation to prove that the term has become the common name in the trade as a result of either:

- action, or
- inaction

on the part of the proprietor.

The Office will examine the facts in accordance with [Article 95\(1\) EUTMR](#) within the scope of factual submissions made by the revocation applicant (13/09/2013, [T-320/10](#), Castel, EU:T:2013:424, § 28). In doing so, it may take into consideration obvious and

well-known facts. However, it will not go beyond the legal arguments submitted by the revocation applicant. If a request for revocation is based only on [Article 58\(1\)\(b\) EUTMR](#), the trade mark could not then be revoked due to being, for example, against public order and morality.

### 2.3.2 Point in time to be considered

The applicant for revocation must prove that the trade mark has become the common name in the trade for the product or service in question after the date of registration of the EUTM, although facts or circumstances that took place between application and registration can be taken into account. The fact that the sign was, at the date of application, the common name used in the trade for the goods or services in respect of which registration was sought would only be relevant in the context of an invalidity action.

### 2.3.3 Relevant public

An EUTM is liable to be revoked in accordance with [Article 58\(1\)\(b\) EUTMR](#) if it has become the common name for the product or service not just among some but among the vast majority of the relevant public, including those involved in the trade for the product or service in question (29/04/2004, [C-371/02](#), Bostongurka, EU:C:2004:275, § 23, 26). Whether a trade mark has become the common name in the trade for a product or service in respect of which it is registered must be assessed not only in the light of the perception of consumers or end users but also, depending on the features of the market concerned, in the light of the perception of those in the trade, such as sellers (06/03/2014, [C-409/12](#), Kornspitz, EU:C:2014:130, § 28). However, in some specific circumstances, it might be sufficient that the sellers of the finished product do not inform their customers that the sign has been registered as a trade mark and do not offer their customers assistance at the time of sale, which includes an indication of the origin of the goods for sale (06/03/2014, [C-409/12](#), Kornspitz, EU:C:2014:130, § 23-25, 30).

### 2.3.4 Common name

A sign is regarded as the 'common name in the trade' if it is established practice in the trade to use the term in question to designate the goods or services for which it is registered (see the Guidelines, [Part B, Examination, Section 4, Absolute Grounds for Refusal, Chapter 5, Customary Signs or Indications \(Article 7\(1\)\(d\) EUTMR\)](#)). It is not necessary to prove that the term directly describes a quality or characteristic of the goods or services, but merely that it is actually used in the trade to refer to those goods or services. The distinctive force of a trade mark is always more likely to degenerate when a sign is suggestive or apt in some way, especially if it has positive connotations that lead others to latch on to its suitability for designating not just a particular producer's product or service but a particular type of product or service (30/01/2007, [1 020 C](#), Stimulation, § 22, 32 et seq.).

The fact that a trade mark is being used as the common name to refer to a specific product or service is an indication that it has lost its ability to differentiate the goods or services in question from those of other undertakings. One indication that a trade mark has become generic is when it is commonly used verbally to refer to a particular type or characteristic of the goods or services. However, this is not in itself decisive: it must be established whether the trade mark is still capable of differentiating the goods or services in question from those of other undertakings.

The absence of any alternative term or the existence of only one long, complicated term may also be an indication that a sign has become the common name in the trade for a specific product or service.

#### 2.3.5 Defence for the proprietor

Where the proprietor of the EUTM has done what could reasonably have been expected in the particular case (e.g. organised a TV campaign or placed advertisements in newspapers and relevant magazines), the EUTM cannot be revoked. The proprietor must then check whether its trade mark appears in dictionaries as a generic term; if it does, the proprietor can request from the publisher that in future editions the trade mark will be accompanied by an indication that it is a registered trade mark ([Article 12 EUTMR](#)).

### 2.4 EUTM becoming misleading — Article 58(1)(c) EUTMR

If, as a result of use made of the mark by the proprietor or with its consent, the mark is liable to mislead the public, particularly concerning the nature, quality or geographical origin of the goods or services for which it is registered, the EUTM can be revoked. In this context, quality refers to a characteristic or attribute rather than a degree or standard of excellence.

#### 2.4.1 Burden of proof

The Office will examine the facts in accordance with [Article 95\(1\) EUTMR](#) within the scope of factual submissions made by the revocation applicant (13/09/2013, [T-320/10](#), Castel, EU:T:2013:424, § 28). In doing so, it may take into consideration obvious and well-known facts. However, it will not go beyond the legal arguments submitted by the applicant for revocation.

The burden of proof that the mark has become misleading rests on the applicant for revocation, who must further prove that it is the use made by the proprietor that causes the misleading effect. If the use is made by a third party, the burden is on the applicant for revocation to prove that the proprietor has consented to that use, unless the third party is a licensee of the proprietor.

#### 2.4.2 Point in time to be considered

The applicant for revocation must prove that the trade mark has become liable to mislead the public, particularly concerning the nature, quality or geographical origin of the goods or services in question, after the date of registration of the EUTM. If the sign was already deceptive or liable to deceive the public at the date of application, this would be relevant in the context of an invalidity action.

#### 2.4.3 Standards to be applied

The Guidelines contain details of the criteria to be applied when assessing whether an EUTM application complies with [Article 7\(1\)\(g\) EUTMR](#) (see the Guidelines, [Part B, Examination, Section 4, Absolute Grounds for Refusal, Chapter 8, Deceptive Trade Marks \(Article 7\(1\)\(g\) EUTMR\)](#)). The criteria are comparable to those applied in revocation proceedings under [Article 58\(1\)\(c\) EUTMR](#).

#### 2.4.4 Examples

A trade mark composed of, or containing, a geographical indication will, as a rule, be perceived by the relevant public as a reference to the place from where the goods originate. The only exception to this rule is where the relationship between the geographical name and the products is manifestly so fanciful (e.g. because the place is not known, and unlikely to become known, to the public as the place of origin of the goods in question) that consumers will not make such a connection.

In this regard, the trade mark MÖVENPICK OF SWITZERLAND was revoked because the goods in question were produced (according to the facts) solely in Germany, not in Switzerland (12/02/2009, [R 697/2008-1](#), MÖVENPICK OF SWITZERLAND).

Moreover, where a trade mark containing the word elements 'goats' and 'cheese' and a figurative element clearly depicting a goat is registered for 'goats' cheese', and use is proven for cheese not made from goats' milk, the EUTM will be revoked.

Where a trade mark containing the word elements 'pure new wool' is registered for 'clothing' and use is proven for clothing manufactured from artificial fibres, the EUTM will be revoked.

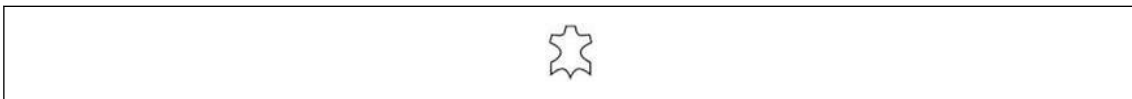

Where a trade mark containing the words 'genuine leather' or the corresponding pictogram is registered for 'shoe wear' and use is proven for shoes not made of leather, the EUTM will be revoked.



## **2.5 Additional grounds for revocation of EU collective marks (Article 81 EUTMR)**

According to [Article 81 EUTMR](#), in addition to the grounds for revocation provided for in [Article 58 EUTMR](#), the rights of the proprietor of an EU collective mark will be revoked on application to the Office or on the basis of a counterclaim in infringement proceedings, if:

1. the proprietor does not take reasonable steps to prevent the mark being used in a manner incompatible with the conditions of use, where these exist, laid down in the regulations governing use, amendments to which have, where appropriate, been mentioned in the Register;
2. the proprietor of the EU collective mark uses it in such a way that it becomes liable to mislead the public as regards the character or significance of the mark, in particular, if it is likely to be taken to be something other than a collective mark, as stated in [Article 76 EUTMR](#);
3. the amended regulations do not satisfy the requirements of [Article 75 EUTMR](#) or involve one of the grounds for refusal referred to in [Article 76 EUTMR](#), but the amendment has been mentioned in the Register in breach of the provisions of [Article 79\(2\) EUTMR](#), unless the proprietor of the mark, by further amending the regulations governing use in order to comply with the requirements of those provisions.

## **2.6 Additional grounds for revocation of EU certification marks (Article 91 EUTMR)**

According to [Article 91 EUTMR](#), in addition to the grounds for revocation provided for in [Article 58 EUTMR](#), the rights of the proprietor of an EU certification mark will be revoked on application to the Office or on the basis of a counterclaim in infringement proceedings, where any of the following conditions is fulfilled:

1. the proprietor carries on a business involving the supply of goods or services of the kind certified, in breach of [Article 83\(2\) EUTMR](#);
2. the proprietor does not take reasonable steps to prevent the mark being used in a manner that is incompatible with the conditions of use laid down in the regulations governing use, amendments to which have, where appropriate, been mentioned in the Register;
3. the manner in which the mark has been used by the proprietor has caused it to become liable to mislead the public in the manner referred to in [Article 85\(2\) EUTMR](#);
4. an amendment to the regulations governing use of the mark has been mentioned in the Register in breach of [Article 88\(2\) EUTMR](#), unless the proprietor of the mark, by further amending the regulations governing use, complies with the requirements of that Article.



### 3 Absolute Grounds for Invalidity

#### 3.1 EUTM registered contrary to Article 7 EUTMR — Article 59(1)(a) EUTMR

An EUTM can be declared invalid if, at the time of its application, an objection could have been raised under any of the grounds listed in [Article 7 EUTMR](#).

##### 3.1.1 Burden of proof

The purpose of invalidity proceedings is, inter alia, to enable the Office to review the validity of the registration of a trade mark and to adopt, where necessary, a position that it should have adopted of its own motion in the registration process in accordance with [Article 42\(1\) EUTMR](#) (30/05/2013, [T-396/11](#), Ultrafilter International, EU:T:2013:284, § 20).

[Article 95\(1\) EUTMR, second sentence](#), explicitly states that in invalidity proceedings pursuant to [Article 59 EUTMR](#), the Office will **limit its examination to the grounds and arguments submitted by the parties**. The EUTM enjoys a **presumption of validity and it is for the invalidity applicant to invoke before the Office the specific facts that call the validity of a trade mark into question** (13/09/2013, [T-320/10](#), Castel, EU:T:2013:424, § 27-29).

Consequently, the Office will examine the facts in accordance with [Article 95\(1\) EUTMR](#), second sentence, within the **scope of factual submissions** made by the applicant for the declaration of invalidity (13/09/2013, [T-320/10](#), Castel, EU:T:2013:424, § 28). In doing so, it may take into consideration obvious and well-known facts. However, it will **not go beyond the grounds and arguments submitted by the applicant** for the declaration of invalidity.

One of the arguments that the EUTM proprietor may put forward against the invalidity applicant's claim is evidence that the EUTM has acquired distinctive character following use. See [paragraph 3.2](#) below.

##### 3.1.2 Points in time to be considered

The General Court has held that whether a trade mark should be registered or should be declared invalid must be assessed on the basis of the situation at the date of its application, not of its registration (03/06/2009, [T-189/07](#), Flugbörse, EU:T:2009:172; confirmed by 23/04/2010, [C-332/09 P](#), Flugbörse, EU:C:2010:225).

Generally speaking, any developments or events after the date of application or priority date will not be taken into consideration. For example, the fact that a sign has, after the date of application, become the common term used in the trade for the goods or services for which registration was sought is in principle irrelevant for the purposes of examining an invalidity action (it would only be relevant in the context of a revocation

action). However, such facts subsequent to the date of application can nevertheless be taken into account where and to the extent that they allow conclusions to be drawn regarding the situation at the date of application for the EUTM. This might be the case, for example, with dictionary extracts that post-date the application date. Unless rapid development of linguistic usage or living conditions (in the sense of social or technical 'trends') has taken place after the date of application, words will usually only be listed in dictionaries if their actual use and meaning has been established over a considerable period of time (25/11/2015, [T-223/14](#), VENT ROLL, EU:T:2015:879, § 39).

### 3.1.3 Standards to be applied

The Guidelines, [Part B, Examination, Section 4, Absolute Grounds for Refusal](#), contain details of the criteria to be applied when assessing whether an EUTM application complies with [Article 7 EUTMR](#). The criteria are identical to those applied in invalidity proceedings under [Article 59\(1\)\(a\) EUTMR](#).

## 3.2 Defence against a claim of lack of distinctiveness

A trade mark that falls foul of [Article 59\(1\)\(a\) EUTMR](#) in conjunction with [Article 7\(1\)\(b\), \(c\) or \(d\) EUTMR](#) will not be declared invalid where it has acquired distinctiveness through use ([Article 59\(2\) EUTMR](#)). The provision of [Article 59\(2\) EUTMR](#) is governed by the same logic as [Article 7\(3\) EUTMR](#) and must be interpreted in the same way and in the light of the same relevant factors (28/06/2019, [T-340/18](#), SHAPE OF A FLYING V GUITAR (3D), EU:T:2019:455, § 64).

The distinctive character acquired following use is, in the context of invalidity proceedings, an exception to the grounds for invalidity of [Article 59\(1\)\(a\) EUTMR](#) in conjunction with [Article 7\(1\)\(b\), \(c\) and \(d\) EUTMR](#). Since it is an exception, the **onus of proof** is on the party seeking to rely on it, namely the proprietor of the contested mark. The proprietor of the contested mark is best placed to adduce evidence in support of the assertion that its mark has acquired a distinctive character following the use which has been made of it (e.g. concerning the intensity, geographical extent, duration of use, promotional investment). Consequently, where the proprietor of the contested mark invokes the distinctive character acquired through use, but fails to adduce evidence thereof, the mark must be declared invalid (19/06/2014, joined cases [C-217/13](#) & [C-218/13](#), Oberbank e.a, EU:C:2014:2012, § 68-71).

The EUTM proprietor may also invoke the defence of acquired distinctiveness on a subsidiary basis and expressly request the Cancellation Division to decide first on the invoked ground of invalidity ([Article 59\(1\)\(a\) EUTMR](#) in conjunction with [Article 7\(1\)\(b\), \(c\) or \(d\) EUTMR](#)).

The Cancellation Division will normally grant these requests (unless the circumstances dictate otherwise, e.g. where the contested mark should be declared invalid on different grounds) and issue an appealable decision on the ground of invalidity invoked (as allowed under [Article 66\(2\) EUTMR](#)). If this results in a finding that [Article 59\(1\)\(a\) EUTMR](#) in conjunction with [Article 7\(1\)\(b\), \(c\) or \(d\) EUTMR](#) applies, and once this

decision has become final, the adversarial part of the proceedings will be reopened in order to give the EUTM proprietor the opportunity to submit evidence in support of its claim of acquired distinctiveness.

The Guidelines, [Part B, Examination, Section 4, Absolute Grounds for Refusal, Chapter 14, Acquired Distinctiveness Through Use \(Article 7\(3\) EUTMR\)](#), contain details of the criteria to be applied when assessing whether an EUTM has acquired distinctiveness through use.

The proprietor must prove that the trade mark has acquired distinctive character at the latest by the date of application for a declaration of invalidity (05/03/2003, [T-237/01](#), BSS, EU:T:2003:54, § 53).

Therefore, evidence of acquired distinctiveness (i) by the application date of the EUTM (or the date of priority where applicable), (ii) between the application date of the EUTM (or the date of priority where applicable) and the date of registration, and (iii) between the date of registration and the date of application for a declaration of invalidity are all relevant.

### 3.3 Bad faith — Article 59(1)(b) EUTMR

The EUTMR considers bad faith only as an absolute ground for the **invalidity** of an EUTM, to be relied on either before the Office or by means of a counterclaim in infringement proceedings. Therefore, bad faith is not relevant in examination or opposition proceedings (for opposition proceedings, 17/12/2010, [T-192/09](#), Seve Trophy, EU:T:2010:553, § 50).

#### 3.3.1 Relevant point in time

The relevant point in time for determining whether there was bad faith on the part of the EUTM owner is the **time of filing of the application for registration**. However, the following must be noted.

- Facts and evidence dated prior to filing can be taken into account for interpreting the owner's intention at the time of filing the EUTM. These facts may include, inter alia, whether there is already a registration of the mark in a Member State, in the Office or in another jurisdiction, the circumstances under which that mark was created and the use made of it since its creation (see [paragraph 3.3.2.1](#) below, third paragraph).
- Facts and evidence dated subsequent to filing can sometimes be used for interpreting the owner's intention at the time of filing the EUTM, in particular whether the owner has used the mark since registration (see [paragraph 3.3.2.1](#) below, third paragraph).

#### 3.3.2 Concept of bad faith

The concept of bad faith referred to in [Article 59\(1\)\(b\) EUTMR](#) is an autonomous concept of European Union (EU) law, which must be given a uniform interpretation in

the EU (preliminary ruling of 27/06/2013, [C-320/12](#), Malaysia Dairy, EU:C:2013:435). However, it is not defined, delimited or even described in any way in the legislation.

Advocate General Sharpston proposed to define it as a 'conduct which departs from accepted principles of ethical behaviour or honest commercial and business practices' (opinion of Advocate General Sharpston of 11/06/2009, [C-529/07](#), Lindt Goldhase, EU:C:2009:148, § 60).

[Article 59\(1\)\(b\) EUTMR](#) meets the general interest objective of preventing trade mark registrations that are abusive or contrary to honest commercial and business practices. These registrations are contrary to the principle that EU law cannot be extended to cover abusive practices on the part of a trader, which do not make it possible to attain the objective of the legislation in question (23/05/2019, [T-3/18 & T-4/18](#), ANN TAYLOR / ANNTAYLOR et al., EU:T:2019:357, § 33).

The ground of bad faith applies where it is apparent from relevant and consistent indicia that the proprietor of an EUTM filed its application for registration not with the aim of engaging fairly in competition, but with the intention of undermining the interests of third parties, in a manner inconsistent with honest practices, or with the intention of obtaining, without even targeting a specific third party, an exclusive right for purposes other than those falling within the functions of a trade mark, in particular the essential function of indicating origin (12/09/2019, [C-104/18 P](#), STYLO & KOTON (fig.), EU:C:2019:724, § 46).

In order to find out whether the owner had been acting in bad faith at the time of filing the application, an **overall assessment** must be made in which all the relevant factors of the individual case must be taken into account (preliminary ruling of 27/06/2013, [C-320/12](#), Malaysia Dairy, EU:C:2013:435, § 37), in particular the whole list of goods and services for which the mark was applied for, even though it was not finally registered for some of them. A **non-exhaustive** list of these factors is given below.

### 3.3.2.1 Factors likely to indicate the existence of bad faith

The case-law shows three factors to be particularly relevant.

1. **Identity or similarity of the signs:** the fact that the EUTM allegedly registered in bad faith is identical or similar to a sign to which the invalidity applicant refers may be significant for finding bad faith. Although there is identity or similarity with an earlier sign in many cases where bad faith is found, likelihood of confusion is not a prerequisite of bad faith (12/09/2019, [C-104/18 P](#), STYLO & KOTON (fig.), EU:C:2019:724, § 51). Finally, identity or similarity of the signs is not in itself sufficient to show bad faith (01/02/2012, [T-291/09](#), Pollo Tropical chicken on the grill, EU:T:2012:39, § 90; 28/01/2016, [T-335/14](#), DoggiS, EU:T:2016:39, § 59-60).
2. **Knowledge of the use of an identical or similar sign:** the fact that the EUTM owner knew or should have known about the use of an identical or similar sign by a third party for identical or similar products or services may also be significant.

There is knowledge, for example, where the parties have been in a business relationship with each other and, as a result thereof, 'could not ignore, and was

probably aware that the invalidity applicant had been using the sign for a long time' (11/07/2013, [T-321/10](#), Gruppo Salini, EU:T:2013:372, § 25), when the reputation of the sign, even as a 'historical' trade mark, is a well-known fact (08/05/2014, [T-327/12](#), Simca, EU:T:2014:240, § 50), or when the identity or quasi-identity between the contested mark and the earlier signs 'manifestly cannot be fortuitous' (28/01/2016, [T-335/14](#), DoggiS, EU:T:2016:39, § 60).

Knowledge **may be presumed to exist** ('must have known') on the basis, inter alia, of general knowledge in the economic sector concerned or of the duration of use. The longer the use of a sign, the more likely it is that the EUTM owner had knowledge of it (11/06/2009, [C-529/07](#), Lindt Goldhase, EU:C:2009:361, § 39). Depending on the circumstances of the case, this presumption may apply even if the sign was registered in a non-EU country (28/01/2016, [T-335/14](#), DoggiS, EU:T:2016:39, § 64-71).

However, knowledge of an identical or similar earlier sign for identical or similar goods or services is **not sufficient in itself** to support a finding of bad faith (11/06/2009, [C-529/07](#), Lindt Goldhase, EU:C:2009:361, § 40, 48-49). It always depends on the circumstances of the case (see, for example, 14/02/2012, [T-33/11](#), Bigab, EU:T:2012:77, § 27).

Similarly, the fact that the applicant knows or should know that, at the time of filing of its application, a third party is **using a mark abroad** that is liable to be confused with the mark whose registration has been applied for is not sufficient, **in itself**, to permit the conclusion that the applicant is acting in bad faith (preliminary ruling of 27/06/2013, [C-320/12](#), Malaysia Dairy, EU:C:2013:435, § 37).

Knowledge or presumption of knowledge of an existing sign is not required where the EUTM owner misuses the system with the intention of preventing **any** similar sign from entering the market (see, for example, the artificial extension of the grace period for non-use in paragraph 3(e) below).

3. **Dishonest intention on the part of the EUTM owner:** this is a subjective factor that has to be determined by reference to objective circumstances (11/06/2009, [C-529/07](#), Lindt Goldhase, EU:C:2009:361, § 42). Again, several factors can be relevant. See, for example, the following case scenarios.
  - a. Bad faith exists where applications for trade marks are diverted from their initial purpose and filed speculatively or solely with a view to obtaining financial compensation (07/07/2016, [T-82/14](#), LUCEO, EU:T:2016:396, § 145).
  - b. Bad faith is found when it can be inferred that the purpose of the EUTM applicant is to 'free-ride' on the reputation of the invalidity applicant (14/05/2019, [T-795/17](#), NEYMAR, EU:T:2019:329, § 51) or on its registered marks and to take advantage of that reputation (08/05/2014, [T-327/12](#), Simca, EU:T:2014:240, § 56), even if those marks have lapsed (21/12/2015, [R 3028/2014-5](#), PM PEDRO MORAGO (fig.), § 25).
  - c. The absence of any intention to use a trade mark for some or all of the goods and services applied for constitutes bad faith in respect thereof if the EUTM applicant acted with the intention of undermining the interest of third parties in a manner inconsistent with honest practices or — without even targeting a specific third

party — of obtaining an exclusive right for purposes other than those falling within the functions of a trade mark. When the absence of any intention to use a trade mark in accordance with the essential functions of a trade mark concerns only certain goods or services referred to in the application for registration, that application constitutes bad faith only insofar as it relates to those goods or services (29/01/2020, [C-371/18](#), SKY, EU:C:2020:45, § 81; 11/06/2009, [C-529/07](#), Lindt Goldhase, EU:C:2009:361, § 44; 07/07/2016, [T-82/14](#), LUCEO, EU:T:2016:396, § 126). However, if there is some commercial logic to the filing of the EUTM and it can be assumed that the EUTM owner did intend to use the sign as a trade mark for the goods for which protection was sought, this would tend to indicate that there was no dishonest intention. For example, this could be the case if the EUTM owner had a commercial incentive to protect the mark more widely, for example an increase in the number of Member States in which the owner generates turnover from goods marketed under the mark (14/02/2012, [T-33/11](#), Bigab, EU:T:2012:77, § 20, 23).

- d. The existence of a direct or indirect relationship between the parties prior to the filing of the EUTM, for example a pre-contractual, contractual or post-contractual (residual) relationship, can also be an indicator of bad faith on the part of the EUTM owner (01/02/2012, [T-291/09](#), Pollo Tropical chicken on the grill, EU:T:2012:39, § 85-87; 11/07/2013, [T-321/10](#), Gruppo Salini, EU:T:2013:372, § 25-32). The EUTM owner's registration of the sign in its own name in such cases can, depending on the circumstances, be considered a breach of honest commercial and business practices.
- e. Bad faith has been found where an EUTM owner tries to artificially extend the grace period for non-use, for example by filing a repeat application of an earlier EUTM in order to avoid the loss of a right as a result of non-use (13/12/2012, [T-136/11](#), Pelikan, EU:T:2012:689, § 27). This case needs to be distinguished from the situation in which the EUTM owner, in accordance with normal business practice, seeks to protect variations of its sign, for example, where a logo has evolved (13/12/2012, [T-136/11](#), Pelikan, EU:T:2012:689, § 36 et seq.).
- f. Bad faith has also been found where the EUTM owner makes a successive chain of applications for registration of national trade marks, designed to grant it a blocking position for a period exceeding the 6-month period of reflection provided for by [Article 34\(1\) EUTMR](#) and even the 5-year grace period provided for by [Article 58\(1\)\(a\) EUTMR](#) (07/07/2016, [T-82/14](#), LUCEO, EU:T:2016:396, § 51).
- g. A request for financial compensation made by the EUTM owner to the invalidity applicant may lead to a finding of bad faith if there is evidence that the EUTM owner knew of the existence of the earlier identical or similar sign and expected to receive a proposal for financial compensation from the invalidity applicant (08/05/2014, [T-327/12](#), Simca, EU:T:2014:240, § 72).

In addition to the abovementioned factors, **other potentially relevant factors** identified in case-law and/or Office practice to assess the existence of bad faith include those listed here.

1. The circumstances under which the contested sign was created, the use made of it since its creation, the commercial logic underlying the filing of the application for



registration of that sign as an EUTM and the chronology of events leading up to that filing (14/02/2012, [T-33/11](#), Bigab, EU:T:2012:77, § 21 et seq.; 08/05/2014, [T-327/12](#), Simca, EU:T:2014:240, § 39; 26/02/2015, [T-257/11](#), COLOURBLIND, EU:T:2015:115, § 68).

2. The nature of the mark applied for. Where the sign for which registration is sought consists of the entire shape and presentation of a product, the fact that the EUTM owner was acting in bad faith at the time of filing might more readily be established where the competitor's freedom to choose the shape of a product and its presentation is restricted by technical or commercial factors, with the result that the EUTM owner is able to prevent its competitors not merely from using an identical or similar sign, but also from marketing comparable products (11/06/2009, [C-529/07](#), Lindt Goldhase, EU:C:2009:361, § 50).
3. The degree of inherent or acquired distinctiveness enjoyed by the invalidity applicant's sign and the EUTM owner's sign, as well as its degree of reputation, even if this is only residual (08/05/2014, [T-327/12](#), Simca, EU:T:2014:240, § 40, 46 and 49).
4. The fact that the national mark on which the EUTM owner has based a priority claim has been declared invalid due to bad faith (30/07/2009, [R 1203/2005-1](#), BRUTT).

Finally, the case-law and/or the Office have identified a number of factors that, considered in isolation, are not enough to find bad faith but that, in combination with other relevant factors (to be identified on a case-by-case basis), might indicate the existence of bad faith.

- The fact that an earlier, very similar, EUTM was revoked for goods or services in a number of classes is not, in itself, sufficient to allow any conclusions to be drawn as to the EUTM owner's intentions at the time of filing the EUTM application for the same goods or services (13/12/2012, [T-136/11](#), Pelikan, EU:T:2012:689, § 45).
- The fact that the application for registration of the contested EUTM is filed 3 months before expiry of the period of grace for the earlier EUTMs is not sufficient to counteract factors that show that the EUTM owner's intention was to file a modernised trade mark covering an updated list of services (13/12/2012, [T-136/11](#), Pelikan, EU:T:2012:689, § 50 and 51).
- The filing of applications for declarations that the invalidity applicant's marks are invalid constitutes the legitimate exercise of an EUTM owner's exclusive right and cannot in itself prove any dishonest intent on its part (13/12/2012, [T-136/11](#), Pelikan, EU:T:2012:689, § 66).
- The fact that, after successfully registering the EUTM at issue, the EUTM owner serves formal notice on other parties to cease using a similar sign in their commercial relations is not in itself an indication of bad faith. Such a request falls within the scope of the rights attaching to the registration of an EUTM; see [Article 9 EUTMR](#) (14/02/2012, [T-33/11](#), Bigab, EU:T:2012:77, § 33). However, in circumstances where this request is connected with other factors (e.g. the mark is not being used), it might be an indication of the intention to prevent another party from entering the market.
- In cases where the EUTM proprietor owns more than one trade mark, the mere fact that the differences between the EUTM at issue and the previous EUTM registered

by the same proprietor are so insignificant as not to be noticeable to the average consumer cannot establish by itself that the contested EUTM is a mere repeat application made in bad faith (13/12/2012, [T-136/11](#), Pelikan, EU:T:2012:689, § 33-34).

### 3.3.2.2 Factors unlikely to indicate the existence of bad faith

Case-law has identified several factors that, in general, are unlikely to prove bad faith.

- Extending the protection of a national mark by registering it as an EUTM falls within a company's normal commercial strategy (14/02/2012, [T-33/11](#), Bigab, EU:T:2012:77, § 23; 01/02/2012, [T-291/09](#), Pollo Tropical chicken on the grill, EU:T:2012:39, § 58).
- Bad faith cannot be found on the basis of the length of the list of goods and services set out in the application for registration (07/06/2011, [T-507/08](#), 16PF, EU:T:2011:253, § 88). As a rule, it is legitimate for an undertaking to seek registration of a mark not only for the categories of goods and services that it markets at the time of filing the application but also for other categories of goods and services that it intends to market in the future (14/02/2012, [T-33/11](#), Bigab, EU:T:2012:77, § 25; 07/06/2011, [T-507/08](#), 16PF, EU:T:2011:253, § 88). Nevertheless as explained under point 3(c) in [paragraph 3.3.2.1 \(Factors likely to indicate the existence of bad faith\)](#), the registration of a trade mark by an applicant without any intention to use it for the goods and services covered by that registration may constitute bad faith where there is no rationale for the application for registration (29/01/2020, [C-371/18](#), SKY, EU:C:2020:45, § 77).
- The fact that the owner of several national marks decides to apply for an EUTM for only one and not all of them cannot be an indication of bad faith. The decision to protect a mark at both national and EU level is a choice dictated by the proprietor's marketing strategy. It is not for the Office or the Court to interfere with this choice (14/02/2012, [T-33/11](#), Bigab, EU:T:2012:77, § 29).
- If a sign enjoys a reputation at national level and the owner applies for an EUTM, the extent of the sign's reputation might justify the owner's interest in ensuring broader legal protection (11/06/2009, [C-529/07](#), Lindt Goldhase, EU:C:2009:361, § 51-52).
- The act of filing an application for cancellation of the earlier trade mark while opposition proceedings brought on the basis of that earlier trade mark are still pending is not evidence of bad faith (25/11/2014, [T-556/12](#), KAISERHOFF (fig.) / KAISERHOFF, EU:T:2014:985, § 12).

### 3.3.3 Proof of bad faith

In invalidity proceedings pursuant to [Article 59 EUTMR](#), the Office will **limit its examination to the grounds and arguments submitted by the parties** ([Article 95\(1\) EUTMR, second sentence](#)).

The cancellation applicant must establish the circumstances that make it possible to conclude that the EUTM was applied for in bad faith. The good faith of the EUTM



applicant is presumed until proven otherwise (23/05/2019, [T-3/18 & T-4/18](#), ANN TAYLOR / ANNTAYLOR et al., EU:T:2019:357, § 34 and case-law cited therein).

Where the Office finds that the objective circumstances of the case may lead to the rebuttal of the presumption of good faith, it is for the EUTM proprietor to provide plausible explanations on the objectives and commercial logic pursued by the application for registration of that mark (23/05/2019, [T-3/18 & T-4/18](#), ANN TAYLOR / ANNTAYLOR et al., EU:T:2019:357, § 36-37).

### 3.3.4 Relation to other EUTMR provisions

Whilst [Article 8\(3\) EUTMR](#) is a manifestation of the principle that commercial transactions must be conducted in good faith, [Article 59\(1\)\(b\) EUTMR](#) is the general expression of that principle (see p. 4 et seq. of the Guidelines, [Part C, Opposition, Section 3, Unauthorised Filing by Agents of the TM proprietor \(Article 8\(3\) EUTMR\)](#)).

### 3.3.5 Extent of invalidity

According to [Article 59\(3\) EUTMR](#), the absolute grounds for invalidity referred to in [Article 59\(1\) EUTMR](#) may, depending on the circumstances, exist in respect of only some of the goods and services for which the contested mark has been registered.

The invalidity applicant can determine the extent of the invalidity action. If it challenges only some of the goods and services covered by the contested EUTM, the Office will limit its assessment to those goods and services.

The **extent of a declaration of invalidity** based on a finding of bad faith will be determined on the basis of the evidence and arguments provided by the invalidity applicant and will depend on the nature of the specific behaviour constituting bad faith.

For example:

- where bad faith is found because the contested EUTM was filed with the deliberate purpose of creating an association with the invalidity applicant (14/05/2019, [T-795/17](#), NEYMAR, EU:T:2019:329, § 55), the EUTM will normally be declared invalid in its entirety;
- where bad faith is found because of the absence of any intention to use the trade mark, the EUTM may be declared only partially invalid if the invalidity applicant cannot adequately establish that such bad faith applies to all the goods and services (29/01/2020, [C-371/18](#), SKY, ECLI:EU:C:2020:45, § 81).

## 3.4 Absolute grounds for invalidity for EU collective marks

Apart from the grounds for invalidity explained above, provided for in Articles [59](#) and [60](#) EUTMR, an EU collective mark that has been registered in breach of the provisions of [Article 76 EUTMR](#) will be declared invalid on application to the Office in the following cases:

- where Articles [74](#) and [75](#) EUTMR are not satisfied, or where the regulations governing use are contrary to public policy or to accepted principles of morality;
- where the public is liable to be misled regarding the character of the significance of the mark, in particular if it is likely to be taken to be something other than a collective mark.

[Article 76\(3\) EUTMR](#) in conjunction with [Article 82 EUTMR](#) *in fine* clarify that where the proprietor amends the regulations of use then meets the requirements of paragraphs [1](#) and [2](#) above, such EU collective mark will not be refused.

### 3.5 Absolute grounds for invalidity for EU certification marks

[Article 92 EUTMR](#) states that when an EU certification mark has been registered in breach of [Article 85 EUTMR](#) (e.g. the conditions in Articles [83](#) and [84](#) EUTMR are not satisfied), it will be declared invalid unless the proprietor amends the regulations governing use, and consequently, these meet the requirements of [Article 85 EUTMR](#).

## 4 Relative Grounds for Invalidity

### 4.1 Introduction

[Article 60 EUTMR](#) enables proprietors of earlier rights to apply for a declaration of invalidity of an EUTM in a range of situations (grounds), which are detailed below.

- The same grounds as in opposition proceedings:
  - an earlier trade mark, within the meaning of [Article 8\(2\) EUTMR](#), is identical or similar to the contested EUTM and covers identical or similar goods and services or is reputed ([Article 60\(1\)\(a\) EUTMR](#) in conjunction with [Article 8\(1\)\(a\) or \(b\)](#) and [Article 8\(5\) EUTMR](#));
  - a trade mark has been filed without authorisation by an agent or representative of its proprietor ([Article 60\(1\)\(b\) EUTMR](#) in conjunction with [Article 8\(3\) EUTMR](#));
  - a non-registered trade mark or other sign used in the course of trade can invalidate an EUTM registration if national legislation allows the proprietor of the earlier non-registered trade mark or another sign to prohibit the use of the subsequent EUTM ([Article 60\(1\)\(c\) EUTMR](#) in conjunction with [Article 8\(4\) EUTMR](#));
  - a designation of origin or a geographical indication can invalidate an EUTM registration if EU or national legislation allows the person authorised under the relevant law to exercise the rights arising from a designation of origin or a geographical indication to prohibit the use of the subsequent EUTM ([Article 60\(1\)\(d\) EUTMR](#) in conjunction with [Article 8\(6\) EUTMR](#)).
- an additional ground based on **another earlier right**, to the extent that EU law or national law (including rights deriving from international agreements having effect in

a Member State) entitles the proprietor to prohibit the use of the contested EUTM ([Article 60\(2\) EUTMR](#)), in particular:

- a right to a name,
- a right of personal portrayal,
- a copyright,
- an industrial property right.

These **grounds** are further developed below (paragraphs [4.2](#) and [4.3](#)).

As in opposition proceedings, the proprietor of the contested EUTM may require the invalidity applicant to submit **proof of genuine use** of its earlier trade mark. The particularities regarding the relevant period for assessing genuine use in invalidity proceedings are explained in [paragraph 4.4](#) below.

Finally, the EUTMR includes a number of provisions that can be invoked by the EUTM proprietor against an invalidity application, depending on the type of earlier right invoked (e.g. whether or not it is an earlier EUTM or national trade mark). These provisions are dealt with under [paragraph 4.5](#) below.

## 4.2 Grounds under Article 60(1) EUTMR

### 4.2.1 Standards to be applied

The substantive conditions for considering an earlier right referred to in [Article 60\(1\) EUTMR](#) in conjunction with [Article 8 EUTMR](#) as a relative ground for a declaration of invalidity are the same as in opposition proceedings. The practice rules relating to the corresponding ground of opposition should be applied accordingly.

### 4.2.2 Points in time to be considered

#### 4.2.2.1 For the assessment of enhanced distinctiveness or reputation

In line with opposition proceedings, in invalidity proceedings an invalidity applicant relying on enhanced distinctiveness or reputation must prove that its earlier right has acquired **enhanced distinctiveness or reputation** by the **filing** date of the contested EUTM, taking account, where appropriate, of any priority claimed. In addition, the reputation or the enhanced distinctive character of the earlier mark must still exist when the **decision on invalidity is taken**.

In opposition proceedings, due to the short time span between the filing of the EUTM application and the opposition decision, it is normally presumed that the enhanced distinctiveness or reputation of the earlier trade mark still exists at the time of the decision (see the Guidelines, [Part C, Opposition, Section 5, Trade Marks with Reputation \(Article 8\(5\) EUTMR\)](#)). In invalidity proceedings, however, the time span can be considerable. In this case, the invalidity applicant must show that its earlier right continues to enjoy enhanced distinctive character or reputation at the time the decision on invalidity is taken.

#### 4.2.2.2 Application based on Article 60(1)(c) EUTMR in conjunction with Article 8(4) EUTMR

In the event of an application for invalidity based on [Article 60\(1\)\(c\) EUTMR](#) in conjunction with [Article 8\(4\) EUTMR](#), the invalidity applicant must show the earlier sign's **use in the course of trade of more than local significance** by the **filing date** of the contested EUTM (or the priority date if relevant). In **invalidity proceedings**, the applicant also has to prove that the sign was used in the course of trade of more than local significance at another point in time, namely **at the time of filing of the invalidity request**. This condition stems from the wording of [Article 60\(1\)\(c\) EUTMR](#), which states that an EUTM will be declared invalid 'where there **is** an earlier right as referred to in [Article 8\(4\)](#) and the conditions set out in that paragraph are fulfilled' (05/10/2004, 606 C; 03/08/2011, [R 1822/2010-2](#), BABY BAMBOLINA (fig.), § 15). Once proved, this requirement is considered still to be fulfilled at the **time the decision on invalidity is taken** unless there is evidence to the contrary (e.g. a company name is invoked but the company has ceased to exist).

There are further particularities regarding **substantiation and admissibility**, which are dealt with in the Guidelines, [Part D, Cancellation, Section 1, Cancellation Proceedings](#).

### 4.3 Grounds under Article 60(2) EUTMR — other earlier rights

An EUTM is liable to be declared invalid on the basis of the rights below where use of the trade mark could be prohibited under the EU or national law governing their protection. This is **not an exhaustive list** of such earlier rights.

[Article 60\(2\) EUTMR](#) applies only where the rights invoked are of such a nature that they are not considered typical rights to be invoked in cancellation proceedings under [Article 60\(1\) EUTMR](#) (13/12/2011, [4 033 C](#), § 12).

#### 4.3.1 A right to a name/right of personal portrayal

Not all Member States protect the right to a person's name or portrayal. The exact scope of protection of the right will follow from the national law (e.g. whether the right is protected irrespective of the goods and services the contested mark covers).

The invalidity applicant will have to provide the necessary **national legislation in force** and put forward a **cogent line of argument** as to why it would succeed in preventing the use of the contested mark under the specific national law. A mere reference to the national law will not be considered sufficient: it is not for the Office to make that argument on the applicant's behalf (05/07/2011, [C-263/09 P](#), Elio Fiorucci, EU:C:2011:452).



Earlier right	Contested sign	Case No
---------------	----------------	---------

TELESIS	TELESIS	08/03/2011, <a href="#">R 134/2009-2</a>
<p><i>Right to a name under Austrian law</i></p> <p>Under Austrian law (Section 43 AGBG), 'the person whose right to use his name has been contested or whose name is used without due [cause] to his detriment, infringing his protectable interests, can request the infringer to cease and desist and to compensate any damages. Such protection extends as well to distinctive designations of traders, even if they deviate from the civil name of that trader ... Even if Section 43 AGBG may also apply to a trader's name, the scope of protection does not go beyond the field of activity of the sign used. The remaining contested services are dissimilar to the services of the earlier right as ... they concern different branches of activity (paras 61-63)'. Thus, the requirements under Austrian law were not fulfilled and the request for invalidity based on <a href="#">Article 53(2)(a) of Regulation No 207/2009</a> [now <a href="#">Article 60(2)(a) EUTMR</a>] in conjunction with Austrian law was rejected.</p>		

Earlier right	Contested sign	Case No
'MARQUÉS DE BALLESTAR' Nobility title (título nobiliario)	 MARQUÉS DE BALLESTAR	03/12/2009, <a href="#">R 1288/2008-1</a>
<p><i>Right to a name under Spanish law</i></p> <p>In Spain, noble titles are protected under Law 1/1982 as if they were persons' names. The applicant for cancellation proved that this noble title exists and that it is held by her. The European Union trade mark comprises a small coat of arms and the words MARQUÉS DE BALLESTAR in large letters. The wine could not be correctly identified in any business transaction without mentioning the words MARQUÉS DE BALLESTAR. The right conferred by the EUTM consists of using this in the following ways: placing it on the product container, putting the product bearing the trade mark onto the market, and using it in publicity (<a href="#">Article 9 EUTMR</a>). Consequently, trade mark use is use 'for publicity, commercial or similar purposes', within the meaning of Article 7(6) of Law 1/1982. Since these uses are considered by this Law as 'unlawful intrusions', the protection provided by Article 9(2) of that same Law would be admissible. This Article allows the adoption of measures to 'put an end to the unlawful intrusion'. The EUTM must be declared invalid because its use can be prohibited as a result of a right to a name in accordance with the Spanish legislation on protection of the right to honour, personal and family privacy and own image (para. 14 et seq.).</p>		

Earlier right	Contested sign	Case No
---------------	----------------	---------

DEF-TEC	DEF-TEC	11/08/2009, <a href="#">R 871/2007-4</a>
<p><i>Right to a name under German law</i></p> <p>The Board considers that ‘what could eventually be protected under § 12 BGB is the name of the cancellation applicant, which is “DEF-TEC Defense Technology GmbH”, but not the sign “DEF-TEC” which is not the cancellation applicant’s name ... the registration, and eventual use as a trade mark, of the designation “DEF-TEC” on pepper sprays cannot infringe the right to the cancellation applicant’s name. ... § 12 BGB protects the names of physical persons and as there is no absolute prohibition to bear a name which is similar to another person’s name, its protection is limited to cases where the right to the other person’s name is denied or misappropriated ... and nothing else applies to the extended application of § 12 BGB to the names of legal persons ... The request for declaration of invalidity fails on account of all the earlier rights invoked’ (para. 38 et seq.).</p>		

Earlier right	Contested sign	Case No
Personality rights of Michael Jackson		17/07/2013, <a href="#">R 944/2012-2</a>
Personality rights of Michael Jackson		17/07/2013, <a href="#">R 878/2012-2</a>

*Right to a personal portrayal under German law*

The request for a declaration of invalidity was based on a right to personal portrayal in Germany according to German national law, namely Sections 823 and 1004 German Civil Code (BGB) in conjunction with Articles 1, 2 of the German Constitution.

The Board finds that the famous person (Michael Jackson) is recognisable in the contested EUTM due to the characteristics resulting from the image that are specific to him and the text that accompanies it. This is considered to be use of an image right according to German case-law, which is a special form of general personality rights protected by German law. The Board finds that the cancellation applicants have sufficiently proved that the right to one's own image is a special form of personality rights protected under German Law, that use of the contested EUTM by the EUTM proprietor infringes Michael Jackson's image and that the cancellation applicants are entitled to prohibit this use according to German law as developed by established German jurisprudence. As a result, the request for a declaration of invalidity of the contested EUTM must be upheld in its entirety ...

#### 4.3.2 Copyright



According to [Article 60\(2\)\(c\) EUTMR](#), a European Union trade mark will be declared invalid on application to the Office where the use of such trade mark may be prohibited pursuant to another earlier right under the EU legislation or national law governing its protection, and in particular copyright.



Although the EU legislator has harmonised certain aspects of copyright protection (see [Directive 2001/29/EC](#) of the European Parliament and of the Council of 22/05/2001 on the harmonisation of certain aspects of copyright and related rights in the information society, OJ L 167, 22/06/2001, pp. 10-19), so far there is no full-scale harmonisation of the copyright laws of the Member States, nor is there a uniform EU copyright. However, all the Member States are bound by the *Berne Convention for the Protection of Literary and Artistic Works* and the *Agreement on Trade-Related Aspects of Intellectual Property Rights* (TRIPS).

The invalidity applicant will have to provide the necessary **national legislation in force** and put forward a **cogent line of argument** as to why it would succeed under the specific national law in preventing the use of the contested mark. A mere reference to the national law will not be considered sufficient: it is not for the Office to make that argument on the applicant's behalf (see, by analogy, 05/07/2011, [C-263/09 P](#), Elio Fiorucci, EU:C:2011:452).

The notion of copyright protection is applicable irrespective of the goods and services the contested mark covers. It merely requires an unauthorised reproduction or adaptation of the protected work or a part thereof in the contested mark. It follows, that similarity for the purposes of the assessment of likelihood of confusion is not the relevant test to be applied.





Earlier right	Contested sign	Case No
		09/09/2010, <a href="#">R 1235/2009-1</a>
<p><i>Copyright under Italian law</i></p> <p>The Board indicates that this ground for invalidity is relative and, therefore, only holders of earlier rights — or other parties, if allowed by the law governing those rights — are entitled to invoke it (<a href="#">Article 56(1)(c) of Regulation No 207/2009</a> [now <a href="#">Article 63(1)(c) EUTMR</a>]). The right relied upon here is copyright. Therefore, the party entitled to act is the holder of the copyright in the flower design or another party authorised by the law governing copyright. The invalidity applicant acknowledges that ownership of the copyright in the design ‘belongs to third parties’ (in fact to one third party: Corel Corporation, the graphic design company). The invalidity applicant does not own the right it seeks to rely upon. It solely has the right to use clip art with the flower shape and use it for purely private purposes. The ground was rejected (para. 32 et seq.).</p>		

Earlier right	Contested sign	Case No
		30/06/2009, <a href="#">R 1757/2007-2</a>
<p><i>Copyright under French law</i></p> <p>‘... the mere fact that the stylisation of the letter ‘G’ is ‘simple’, does not exclude its protection under French copyright law ... Indeed, for a work of the mind to be protected, it is sufficient for it to be “original” ... While it is true that the contested EUTM is not an exact copy of the earlier work, it must be borne in mind that the partial reproduction and adaptation without the consent of the owner of the copyright is also prohibited. The Board considers this to be the case here. The contested EUTM has taken all the essential characteristic features of the prior work: a stand-alone capital ‘G’ in straight, thick, black lines, in a perfectly square flattened shape ... the ‘G’ of the contested EUTM is drawn in a thick, black line of equal width and its inner part reaches further inside, than is the case in the prior work. However, the difference in these minor details constitute minimal modifications which do not affect the overlap in the essential characteristic features of the earlier work, namely, a stand-alone capital ‘G’ with a perfectly rectangular form, a flattened shape and thick, black lines ... As the partial reproduction or adaptation of the prior work has been done without the owner’s consent, it is unlawful. Therefore, the contested decision must be annulled and the request for a declaration of invalidity ... must be upheld’ (para. 33 et seq.).</p>		

Earlier right	Contested sign	Case No
---------------	----------------	---------



		<p>16/05/2012, <a href="#">R 1925/2011-4</a></p>
<p><i>Copyright under German law</i></p> <p>'Pursuant to § 1 of the German Copyright Act, copyright protection is granted to the "authors" of "works of literature, science, or art". § 2 of the Act lists various types of work considered works of art. Pursuant to § 16 et seq., the copyright law protects the author. Under the assumption that the claimed subject-matter constituted a "work" in the sense of those provisions, the cancellation applicant failed to demonstrate and to prove who was its author, and, how the cancellation applicant (a legal person with its seat in Japan) acquired the exclusive rights from the author' (paras 12-13). The Board examined each of these aspects. Moreover, it describes the differences between trade mark similarity and copying for the purposes of copyright infringement. The cancellation applicant had mixed up both concepts (paras 22-24).</p>		



Earlier right	Contested sign	Case No
		<p>05/03/2012, <a href="#">5377 C</a></p>
<p><i>Copyright protected in the United Kingdom</i></p> <p>Section 1(1)(a) of UK Copyright Designs Patents Act 1988 (CDPA) provides that a copyright subsists in original artistic works; Section 4(1) CDPA defines an 'artistic work' as 'a graphic work, photograph, sculpture or collage irrespective of artistic quality'. Section 4(2) CDPA defines a 'graphic work' as including any 'painting, drawing, diagram, map, chart ... plan ... engraving, etching, lithograph, woodcut or similar work'. The Cancellation Division held, at the outset, that the applicants have established that both logos were created by their authors at a time prior to the filing of the EUTM. The designs at issue can be considered to meet also the substantive standards of the protection in the UK. The similarities are 'original and so marked as to warrant a finding that the one has been copied from the other', or expressed in other words, similarities are 'sufficiently numerous or extensive to justify an inference of copying'. Accordingly, the similarities between the copyrights and the contested EUTM are such that they are sufficiently close, numerous and extensive to be rather the result of copying than of coincidence. For the above reasons, the contested EUTM must be declared invalid since its use may be prohibited under Section 16(3) CDPA, which applies by virtue of <a href="#">Article 53(2)(c) of Regulation No 207/2009</a> [now <a href="#">Article 60(2)(c) EUTMR</a>] (paras 36-49).</p>		

### 4.3.3 Other industrial property rights

Other industrial property rights and prior works at national or EU level, such as a registered Community design (RCD), may be invoked.

The invalidity applicant will have to provide the necessary national legislation in force and put forward a cogent line of argument as to why it would succeed under the specific national law in preventing the use of the contested mark. A mere reference to the national law will not be considered sufficient: it is not for the Office to make that argument on the applicant's behalf (see, by analogy, 05/07/2011, [C-263/09 P](#), Elio Fiorucci, EU:C:2011:452).

In the case of an RCD there is no need to prove what protection is given under the law. The Cancellation Division will apply the standards of the applicable design law of the EU.

Earlier right	Contested sign	Case No
 <p>(earlier RCD)</p>	 <p>(shape of a teabag)</p>	<p>14/02/2012, <a href="#">R 2492/2010-2</a></p>
<p>'Article 19(1) Council Regulation CDR states that a registered Community design confers on its holder the exclusive right to use it and to prevent any third party not having his consent from using it. The aforementioned use covers, in particular, the making, offering, putting on the market, importing, exporting or using of a product in which the design is incorporated or to which it is applied, or stocking such a product for those purposes. According to Article 10(1) CDR the scope of the protection conferred by a Community design includes any design which does not produce on the informed user a different overall impression. The earlier RCD and the contested EUTM provoke a different overall impression. ... Furthermore, it is observed that the earlier RCD introduces additional differences, such as the presence of a remarked base that does not form part of the contested EUTM. Consequently, the Board confirms the Cancellation Division finding that the rights conferred by RCD No 241 427 pursuant to Article 19(1) CDR cannot be invoked against the contested EUTM' (paras 59-64).</p>		

**Fast-track: 31/03/2023**

## 4.4 Non-use of the earlier mark

According to [Article 64\(2\) and \(3\) EUTMR](#), where the **earlier mark has been registered for 5 years or more** when the application for a declaration of invalidity is filed, the proprietor of the EUTM may request that the proprietor of the earlier mark

submit proof that the earlier mark has been put to genuine use in the EU in connection with the goods or services for which it is registered or that proper reasons for non-use exist.

According to [Article 19\(2\) EUTMDR](#) in conjunction with [Article 10\(3\) EUTMDR](#), the indications and evidence of use must establish the place, time, extent and nature of use of the earlier trade mark for the goods and services for which it is registered and on which the application for a declaration of invalidity is based.

The practice rules applicable to the **substantive assessment** of proof of use of earlier rights in opposition proceedings are applicable to the assessment of proof of use in invalidity proceedings (see the Guidelines, [Part C, Opposition, Section 7, Proof of use](#)). In particular, when the EUTM proprietor requests proof of use of the earlier rights, the Office will examine whether, and to what extent, use has been proved for the earlier marks, provided this is relevant for the outcome of the decision.

Finally, there is a particularity to be taken into account in the assessment of proof of use in the context of invalidity proceedings. It regards the **relevant time of use**. Pursuant to [Article 64\(2\) EUTMR](#) in conjunction with [Article 47\(2\) EUTMR](#), in contrast to opposition proceedings, there are two relevant periods during which use has to be established.

- The first relevant period applies in all cases where the earlier trade mark had been registered for more than 5 years prior to the application for invalidity: the period of 5 years preceding the date of **filing** of the application for a declaration of invalidity (first relevant period).
- Additionally, in cases where the earlier trade mark had been registered for at least 5 years, in the case of a contested EUTM, on the date of filing or, where applicable, priority <sup>(86)</sup>, and, in the case of a contested international registration designating the EU, on the date of international registration (INID code 151) or subsequent designation (INID code 891), or, as the case may be, the date of priority (INID code 300) of the contested international registration <sup>(87)</sup>: the period of 5 years preceding that date (second relevant period).

These two relevant periods do not necessarily overlap: they may totally or partially overlap or follow on from each other (with or without a gap). In the event of an overlap in the periods, proof of use of the earlier mark relating to the period of overlap can be taken into account for each of the two relevant periods (29/11/2018, [C-340/17 P](#), *Alcolock*, EU:C:2018:965, § 84).

---

<sup>86</sup> For contested EUTM applications filed before 23/03/2016, the relevant date is the date of publication.

<sup>87</sup> For contested international registrations designating the EU filed before 23/03/2016, the relevant date is the date of first publication of the contested IR or its subsequent designation in the EUTM Bulletin.

## 4.5 Defences against an invalidity application based on relative grounds

### 4.5.1 Consent to registration

According to [Article 60\(3\) EUTMR](#), the EUTM may not be declared invalid if the owner of the earlier right consents expressly to the registration of the EUTM before filing the application for a declaration of invalidity.

Consent does not have to be given before the date of registration of the EUTM. It is sufficient if it is given before the application for invalidity is filed. For these purposes, the Office will take into account, for instance, a contract to this effect between the parties.

Evidence of express consent must take the form of a statement (and not of conduct). The statement must come from the applicant (and not from third parties). The consent must be 'express' (and not implicit or presumed) (23/07/2009, [R 1099/2008-1](#), BRANDY MELVILLE (fig.) / MELVILLE (fig.) et al., § 46). The burden of proof for this consent lies with the EUTM proprietor.

The peaceful coexistence of the marks on the market cannot take the place of the 'express consent' of the right holder for the purposes of [Article 60\(3\) EUTMR](#). Furthermore, the coexistence agreement cannot be interpreted in such a way as to extend beyond its scope without the express consent of the parties (03/06/2015, [T-544/12](#) & [T-546/12](#), PENZA PHARMA, EU:T:2015:355, § 40, 50).

Merely withdrawing an opposition unilaterally does not imply that the opponent consents to the registration of the EUTM application (14/10/2008, [R 946/2007-2](#) & [R 1151/2007-2](#), VISIONIC/Visonic LTD (fig.), § 26). Therefore, the Office will analyse the circumstances under which withdrawal of the opposition has been made (see examples below, namely 03/06/2015, [T-544/12](#) & [T-546/12](#), PENZA PHARMA; 14/10/2008, [R 946/2007-2](#) & [R 1151/2007-2](#), VISIONIC/Visonic LTD (fig.)).

#### 4.5.1.1 Examples rejecting the claim of consent to registration

Earlier right	Contested sign	Case No
PENTASA	PENSA PHARMA 	03/06/2015, <a href="#">T-544/12</a> , EU:T:2015:355; 03/06/2015, <a href="#">T-546/12</a> , EU:T:2015:355

In the letters sent to the Office and to the applicant, the interveners expressly stated that the withdrawal of the oppositions would be followed up with applications for a declaration of invalidity once those marks were registered. The Court concluded that in those circumstances, the withdrawals in question cannot be interpreted as being tantamount to the interveners' express consent, for the purposes of [Article 53\(3\) of Regulation No 207/2009](#) [now [Article 60\(3\) EUTMR](#)] to the registration of the contested marks. That withdrawal does not, in law, have any effect on the lawfulness of the filing of a future application for a declaration of invalidity. There is no provision in the EUTMR that provides, at least expressly, that the withdrawal of an opposition entails the renunciation of the right to file an application for a declaration of invalidity (paras 43-45).

The Court also stated that there is no consent to the extension of the coexistence agreement to the contested mark and goods (para. 51). The mark to which the coexistence agreement relates and the contested figurative mark are different, with the result that coexistence agreement cannot apply to the latter mark, to which it does not relate, and which is not, in any event, identical to the mark covered by the agreement (para. 53).

#### 4.5.1.2 Examples accepting the claim of consent to registration

Earlier right	Contested sign	Case No
	VISIONIC	<a href="#">R 946/2007-2</a> , <a href="#">R 1151/2007-2</a>
<p>The cancellation applicant made the express offer 'to withdraw the opposition' in exchange for the limitation of the list of goods applied for on the part of the proprietor. The Board of Appeal noted that the unequivocal offer, corresponding to the subsequent limitation of the list of goods, became legally binding as soon as it was accepted by the proprietor. It was conclusively executed by the express, unconditional (once the condition of the limitation had been fulfilled) and unequivocal withdrawal of the opposition filed by the cancellation applicant. Taking into account the foregoing, the Board concluded that the cancellation applicant consented expressly and unequivocally to the registration of the contested EUTM, which therefore should not have been declared invalid by the contested decision ... (paras 27, 30 and 31).</p>		

Earlier right	Contested sign	Case No
SKYROCK		29/09/2011, <a href="#">R 1736/2010-2</a>

The EUTM proprietor argued that by virtue of the coexistence agreement, the cancellation applicant had effectively consented to the registration of the contested EUTM pursuant to [Article 53\(3\) of Regulation No 207/2009](#) [now [Article 60\(3\) EUTMR](#)]. The Board of Appeal examined the coexistence agreement and the interpretation thereof by the French courts. It concluded that the French courts construed the coexistence agreement as conferring a right on the part of the EUTM proprietor to register marks, other than 'SKYROCK' and 'SKYZIN', that contain the prefix 'SKY'. 'That agreement has a worldwide scope of application and therefore applies to European Union trade mark applications or registrations, such as the one in dispute in the present case' (para. 32).

#### 4.5.2 Acquiescence

According to [Article 61 EUTMR](#), where the proprietor of an earlier EUTM or national trade mark has acquiesced in the use of the contested EUTM for a period of five successive years, while being aware of the use, the contested EUTM is not liable to be declared invalid, unless registration of the later EUTM was applied for in bad faith.

The aim of [Article 61 EUTMR](#) is to penalise the proprietors of earlier trade marks that have acquiesced, for a period of five successive years, in the use of a later EUTM while being aware of such use, by excluding them from seeking a declaration of invalidity of that trade mark, which will then therefore be able to coexist with the earlier trade mark (28/06/2012, [T-133/09](#), B. Antonio Basile 1952, EU:T:2012:327, § 32).

The burden of proof is on the proprietor of the contested EUTM to show that:

- the contested EUTM was used in the EU (or in the Member State where the earlier trade mark is protected) during a period of at least five successive years;
- the invalidity applicant was **actually** aware of this use (04/10/2018, [T-150/17](#), FLÜGEL / ... VERLEIHT FLÜGEL et al., EU:T:2018:641, § 34-35);
- although the invalidity applicant could have stopped the use, it nevertheless remained inactive (22/09/2011, [C-482/09](#), Budweiser, EU:C:2011:605, § 44). This is not the case where there was a licence or distribution relationship between the parties, so that the invalidity applicant could not lawfully oppose use of the sign.

All three conditions must be fulfilled. If they are, the limitation on acquiescence will apply only to the contested goods or services for which the later EUTM has been used.

The period of limitation as a consequence of acquiescence starts running from the time when the proprietor of the earlier trade mark **becomes aware** of the use of the later EUTM. That date must necessarily be later than that of registration of the contested EUTM, that is, when the rights in an EUTM are obtained and it is used as a registered trade mark on the market with third parties therefore being aware of its use. It is at this point that the proprietor of the earlier mark has the option of not acquiescing in its use and, therefore, opposing it or seeking a declaration of invalidity of the later trade mark (28/06/2012, [T-133/09](#), B. Antonio Basile 1952, EU:T:2012:327, § 33; 06/06/2013, [C-381/12 P](#), B. Antonio Basile 1952, EU:C:2013:371, § 56; 04/10/2018, [T-150/17](#), FLÜGEL / ... VERLEIHT FLÜGEL et al., EU:T:2018:641, § 32-33).

The proprietor of the contested mark cannot be required to prove, in addition to the invalidity applicant's awareness of the **use** of the contested EUTM, that the invalidity applicant was also aware of its **registration**, for at least 5 years, as an EUTM. The reference in [Article 61\(1\) and \(2\) EUTMR](#) to acquiescence in the use of a later 'EUTM' merely refers to the requirement that the later sign must have been registered as an EUTM for at least 5 years. This is an objective requirement, which is independent of the invalidity applicant's knowledge (21/10/2008, [R 1299/2007-2](#), Ghibli (fig.), § 41-47).

The proprietor of the contested mark must prove use of the contested mark to the extent that it can be established that the proprietor of the earlier mark was actually aware of this use (04/10/2018, [T-150/17](#), FLÜGEL / ... VERLEIHT FLÜGEL et al., EU:T:2018:641, § 41-42).

[Article 61 EUTMR](#) is not applicable when the contested EUTM was filed in bad faith. This exception will only be considered if it is argued and proved by the invalidity applicant.

[Article 61 EUTMR](#) does not refer to the possible consequences of acquiescence by a person authorised to exercise the rights arising from a designation of origin or a geographical indication. Therefore, the proprietor of an EUTM cannot rely on acquiescence where an invalidity application is based on an earlier designation of origin or a geographical indication pursuant to [Article 8\(6\) EUTMR](#).



#### 4.5.2.1 Examples rejecting the acquiescence claim

Earlier right	Contested sign	Case No
BASILE		28/06/2012, <a href="#">T-133/09</a> , B António Basile 1952, EU:T:2012:327  (06/06/2013, <a href="#">C-381/12 P</a> , B. António Basile 1952, EU:C:2013:371 appeal dismissed)
<p>The appeal applicant did not adduce 'any evidence capable of establishing when the intervener became aware of the use of the contested trade mark after its registration. It merely stated that the contested trade mark had been used for more than five years in Italy and that the intervener must have been aware of that use. Nevertheless, ... less than five years had elapsed between the date of registration of the contested trade mark and the date when the application for a declaration of invalidity was filed, as use of that mark prior to its registration is not relevant since it had not yet been registered' (para. 34).</p>		

Earlier right	Contested sign	Case No



DIABLO	DIABLO	02/07/2012, <a href="#">R 1022/2011-1</a>
<p>'In the case at hand, the contested European Union trade mark was registered on 11 April 2007 and the request for invalidity was filed on 7 July 2009. Thus, the contested mark had been registered as a European Union trade mark for less than five years. Given that one of the conditions provided for in <a href="#">Article 54(2) of Regulation No 207/2009</a> [now <a href="#">Article 61(2) EUTMR</a> ] is not fulfilled, the Board concludes that the Cancellation Division was right in holding that the applicant has not acquiesced in the use of the EUTM' (paras 25-26).</p>		

Earlier right	Contested sign	Case No
		20/07/2012, <a href="#">R 2230/2010-4</a> (confirmed 23/10/2013, <a href="#">T-417/12</a> , Aqua flow, EU:T:2013:550)
<p>'The late evidence [submitted] by the EUTM proprietor shows that in 2005 "AQUA FLOW" branded products were being distributed by various companies in Spain including Hydro Sud. It is claimed that the cancellation applicant was aware of that use. The EUTM proprietor furnished three invoices to third companies located in Spain: "Hydro Sud", "Tonocolor SL Hydro Sud" and "H2O Problematica del Agua". These invoices are dated 18 June 2004, 31 May 2005 and 31 July 2006 and contain headings with a representation of the mark "AQUA FLOW". However, all these invoices postdate May 2004 (five years before the date of the cancellation request (May 2009). Under the assumption that the cancellation applicant had knowledge of them, or of the underlying commercial transactions, this would not be enough for the finding that there was an uninterrupted period of five years preceding the cancellation request ...' (paras 21-22). Therefore, the EUTM proprietor's claim of acquiescence was dismissed.</p>		

Earlier right	Contested sign	Case No
	PURELL	02/02/2012, <a href="#">R 1317/2009-1</a>



' [Article 54\(2\) of Regulation No 207/2009](#) [now [Article 61\(2\) EUTMR](#) ] requires that the contested European Union trade mark be used for five successive years in Germany and that the cancellation applicants have acquiesced in this use for this period. In the present case, the arguments and materials submitted by the parties do not allow for the conclusion that the contested mark was used in Germany and that the cancellation applicants could reasonably be presumed to be aware of that use and to have acquiesced, for five successive years, in that use ... the sole elements that would suggest some connection with Germany and on which the EUTM proprietor relies primarily on appeal (i.e. the figures related to the unique local distributor and the internet excerpts examined in light of the correspondence of 2001 between the parties) are insufficient to hold that the cancellation applicants have acquiesced in the long and well-established honest use of the contested mark in Germany' (para. 47).

Earlier right	Contested sign	Case No
	BONA	04/03/2015, <a href="#">R 267/2014-2</a>

The request for invalidity is based on the earlier UK trade mark registration. There was no dispute as to the fact that there was a verbal coexistence agreement in force concerning the United Kingdom from 2004 onwards (although there was no agreement as to its exact content). The Board indicates that as long as there existed coexistence agreement between the parties, the cancellation applicant had no reason to prohibit this use of the latter EUTM.

In the present case the moment in time when the proprietor of the earlier trade had the option of not acquiescing in the use of the contested EUTM could be 16/02/2010, when, according to the cancellation applicant, the verbal agreement between the parties was breached and ceased. There is no evidence that the cancellation applicant had this option earlier. The application for a declaration of invalidity was filed on 11/07/2012 and, therefore, less than five successive years had passed between the end of the verbal agreement, in other words, from the moment when the cancellation applicant gained the option of not acquiescing in the use of the contested EUTM, and the application for a declaration of invalidity (paras 31-33).

Earlier right	Contested sign	Case No
...VERLEIHT FLÜGEL	FLÜGEL	04/10/2018, <a href="#">T-150/17</a> , FLÜGEL,EU:T:2018:641

The invoices did not demonstrate to a sufficient degree the use of the contested mark in order to establish the intervener's **actual** awareness of that use. ... although a relatively low volume of sales is capable of showing a certain use of a mark, that volume may be insufficient to establish that the proprietor of the earlier mark was actually aware of that use (paras 41-42). The proprietor of the contested mark merely makes general statements as regards the goods covered by the marks at issue being offered for sale in the same establishments, but does not provide any specific element establishing that the representatives of the proprietor of the earlier mark were actually aware of the use of the contested mark (para. 42). In the absence of further detailed information, it cannot be inferred from the sponsorship of a singer and his statement that goods under the contested mark were sold in an establishment also frequented by the representatives of the proprietor of the earlier mark, that the proprietor of the earlier mark had been aware of such commercial use (para. 43). The declaration of the owner of an establishment claiming visits by the representatives of the proprietor of the earlier mark in his establishment also cannot constitute evidence of sufficient value in the absence of further specific information of the claimed visits (para. 45). Awareness of (infringing) use **outside** the relevant territory cannot establish awareness of use **within** the relevant territory (paras 47-48). Any awareness, by the proprietor of the earlier mark, of the use of **other** marks similar to the contested mark, is not sufficient to establish its **actual** awareness of the use of the contested mark (para. 48).

4.5.2.2 Examples (partially) accepting the acquiescence claim

Earlier right	Contested sign	Case No
CITYBOND	CITIBOND	<a href="#">3971 C</a> 26/03/2012
<p>Taking the evidence as a whole, it showed that all the conditions for acquiescence were met for some of the contested services. In particular, the exchange of letters between the parties showed that the applicant was aware of the existence of the EUTM 'CITIBOND' for some of the services. Moreover, the extracts and the statutory declaration (2003) included in proceedings in the UK, and the rest of the financial information, demonstrated that the applicant was conscious of the use of the EUTM 'CITIBOND' in the UK, bearing in mind that the financial market is very specific and highly specialised.</p>		

Earlier right	Contested sign	Case No
Ghibli et al.		21/10/2008, <a href="#">R 1299/2007-2</a>

The cancellation applicant acknowledged that he was aware of the use of this sign, in Italy. The legal issue was whether ... the cancellation applicant also had to be aware of the legal status of the sign used, namely, that it had been used as a registered EUTM in Italy. In the Board's view, [Article 53\(2\) of Regulation No 207/2009](#) [now [Article 60\(2\) EUTMR](#)] cannot be interpreted to require the EUTM proprietor to prove — in addition to the 5 years' concurrent use, knowingly tolerated by the proprietor of the earlier right — that the cancellation applicant also knew, for at least 5 years, that the later mark was protected as an EUTM. What matters in this context is the objective circumstance that the sign (the use of which has been knowingly tolerated by the cancellation applicant), must have existed, for at least 5 years, as an EUTM. In view of the evidence in the file, it was proven that when the request for a declaration of invalidity was filed, the cancellation applicant had been aware and tolerated the use of the contested EUTM in Italy for more than 5 years, irrespective of whether or not he was aware of the fact of registration (para. 35 et seq.).

## **Annex 1 Grounds for Invalidity: Temporal Scope of Application Following the Entry into Force of Regulation (EU) 2015/2424 on 23 March 2016**

### **1 Absolute Grounds for Invalidity**

The general principle is that the Office applies those absolute grounds for invalidity that were laid down in the law to a European Union trade mark (application) — that is, either in [Regulation \(EC\) No 207/2009](#) or in any other directly applicable legislative text binding the EU and thus the Office — **at the date of their filing**.

Therefore, the **new** grounds for invalidity, that is, those that have been introduced to the EUTMR by [Regulation \(EU\) 2015/2424](#), apply only to a European Union trade mark (application) filed on and after 23 March 2016.

However, some grounds for refusal and invalidity introduced for the first time by [Regulation \(EU\) 2015/2424](#) into the EUTMR are, as a matter of law, not new as they had already been applied before 23 March 2016, by virtue of other binding legislative texts of the EU.

On this basis, the following distinction applies:

#### **1.1 Grounds for invalidity that applied before 23 March 2016 by virtue of EU regulations other than the CTMR**

The following grounds for invalidity introduced for the first time into the EUTMR by [Regulation \(EU\) 2015/2424](#) apply to European Union trade marks filed before 23 March 2016.

- [Article 7\(1\)\(k\) EUTMR](#): conflict with earlier EU traditional terms for wines  
This ground for invalidity was already envisaged in [Article 113\(2\) of Regulation \(EU\) No 1308/2013](#) of the European Parliament and of the Council of 17 December 2013 establishing a common organisation of the markets in agricultural products and repealing Council Regulations (EEC) No [922/72](#), (EEC) No [234/79](#), (EC) No [1037/2001](#) and (EC) No [1234/2007](#) in conjunction with Articles [40](#) and [41](#) of Commission Regulation (EC) No 607/2009 of 14 July 2009 laying down certain detailed rules for the implementation of [Council Regulation \(EC\) No 479/2008](#) as regards protected designations of origin and geographical indications, traditional terms, labelling and presentation of certain wine sector products.
- [Article 7\(1\)\(l\) EUTMR](#): conflict with earlier EU traditional specialties guaranteed  
This ground for invalidity was already envisaged in [Article 24 of Regulation \(EU\) No 1151/2012](#) of the European Parliament and of the Council of 21 November 2012 on quality schemes for agricultural products and foodstuffs.
- [Article 7\(1\)\(m\) EUTMR](#): conflict with earlier EU plant variety denominations

This ground for invalidity was already envisaged in [Council Regulation \(EC\) No 2100/94](#) of 27/07/1994 on Community plant variety rights. The Office applied this Regulation in conjunction with [Article 7\(1\)\(f\) EUTMR](#).

## 1.2 Grounds for invalidity that were not envisaged by EU law before the entry into force of Regulation (EU) 2015/2424 on 23 March 2016

The following grounds for invalidity did not exist in EU law before the entry into force of [Regulation \(EU\) 2015/2424](#) and apply therefore only to European Union trade marks filed on and after 23 March 2016.

- ‘Other characteristics’ (than the shape), under [Article 7\(1\)\(e\) EUTMR](#).
- Conflicts with an earlier PGI/PDO protected at **national** level, under [Article 7\(1\)\(j\) EUTMR](#).
- Conflicts with an earlier plant variety denomination protected at **national** level, under [Article 7\(1\)\(m\) EUTMR](#).

## 2 **Relative Grounds for Invalidity, Namely Article 60(1)(d) EUTMR in Conjunction with Article 8(6) EUTMR and the Relationship with Article 60(1)(c) EUTMR in Conjunction with Article 8(4) EUTMR**

[Regulation \(EU\) 2015/2424](#) amending Regulation (EC) No 207/2009 on the Community trade mark (Amending Regulation) introduced [Article 53\(1\)\(d\) of Regulation No 207/2009](#) in conjunction with [Article 8\(4a\) of Regulation No 207/2009](#) [now [Article 60\(1\)\(d\) EUTMR](#) in conjunction with [Article 8\(6\) EUTMR](#)] as a specific ground for invalidity for designations of origin and geographical indications (GIs) protected under EU or national law.

Prior to that, GIs could form the basis of an application for invalidity pursuant to [Article 53\(1\)\(c\) of Regulation No 207/2009](#) in conjunction with [Article 8\(4\) of Regulation No 207/2009](#). However, the introduction of this specific ground means that as of the entry into force of [Article 53\(1\)\(d\) of Regulation No 207/2009](#), GIs can only be invoked under the new ground. GIs can no longer form the basis of an application for invalidity under [Article 53\(1\)\(c\) of Regulation No 207/2009](#), even though the wording of that provision has not changed. Nevertheless, if an invalidity request based on a GI is filed after entry into force of the Amending Regulation, incorrectly indicating [Article 53\(1\)\(c\) of Regulation No 207/2009](#) as a ground for invalidity, the Office will examine the request to the extent that it is clearly based on a GI, as if the ground invoked were [Article 53\(1\)\(d\) of Regulation No 207/2009](#). In such a case, there is no doubt as to the intention of the invalidity applicant to invoke the provision protecting earlier GIs.

[Article 53\(1\)\(c\) of Regulation No 207/2009](#), in conjunction with [Article 8\(4\) of Regulation No 207/2009](#), continues to apply in invalidity proceedings based on GIs pending at the time of entry into force of the Amending Regulation.

As stated above, only [Article 8\(4a\) of Regulation No 207/2009](#) can be invoked in applications for invalidity based on GIs as of the date of entry into force of the Amending Regulation. In the absence, on the one hand, of any transitory provisions and temporal restrictions as regards contested European Union trade marks in the Amending Regulation, and, on the other, considering that GIs were also a ground for refusal under the previous regime and that their use in the course of trade is inherent in their function, as of its entry into force, [Article 53\(1\)\(d\) of Regulation No 207/2009](#) in conjunction with [Article 8\(4a\) of Regulation No 207/2009](#) can be invoked against EUTMs regardless of their filing or priority date, and therefore even against EUTMs filed and registered with the Office before the entry into force of the Amending Regulation.

The protection afforded to GIs by [Article 53\(1\)\(d\) of Regulation No 207/2009](#) in conjunction with [Article 8\(4a\) of Regulation No 207/2009](#) is therefore a continuation of the protection previously afforded by [Article 53\(1\)\(c\) of Regulation No 207/2009](#) in conjunction with [Article 8\(4\) of Regulation No 207/2009](#) . GIs thus invoked under [Article 53\(1\)\(d\) of Regulation No 207/2009](#) in conjunction with [Article 8\(4a\) of Regulation No 207/2009](#) had already to be protected at the time of filing the contested EUTM and be entitled to prohibit use of a subsequent trade mark. Furthermore, the essential conditions for protection of such earlier GIs as provided for by relevant EU or national legislation (e.g. protection against any direct or indirect commercial use; misuse, imitation or evocation; false or misleading indication or other misleading practice) applied already at the filing or priority date of the contested EUTM, even if filed before the entry into force of the Amending Regulation. [Article 8\(4a\) of Regulation No 207/2009](#) better reflects the requirements of EU legislation, which does not require that a GI is used in the course of trade in order for it to be entitled to prevent unauthorised use.

Nevertheless, [Article 63\(3\) EUTMR](#) prevents an applicant whose previous request for invalidity based on a GI under [Article 53\(1\)\(c\) of Regulation No 207/2009](#) has been adjudicated on its merits from filing a new application for invalidity under [Article 53\(1\)\(d\) of Regulation No 207/2009](#) on the basis of the same GI against the same contested mark.

---

**GUIDELINES FOR EXAMINATION**

**EUROPEAN UNION**  
**INTELLECTUAL PROPERTY OFFICE**  
**(EUIPO)**

***Part E***

***Register operations***

---

## Table of Contents

<b>Section 1 Changes in a registration.....</b>	<b>1490</b>
<b>Section 2 Conversion.....</b>	<b>1510</b>
<b>Section 3 EUTMs and RCDs as objects of property.....</b>	<b>1530</b>
<b>Section 4 Renewal.....</b>	<b>1592</b>
<b>Section 5 Inspection of files.....</b>	<b>1615</b>
<b>Section 6 Other entries in the register.....</b>	<b>1642</b>



**GUIDELINES FOR EXAMINATION OF  
EUROPEAN UNION TRADE MARKS**

**EUROPEAN UNION  
INTELLECTUAL PROPERTY OFFICE  
(EUIPO)**

***Part E***

***Register operations***

***Section 1 Changes in a  
registration***

## Table of Contents

<b>1 Surrender.....</b>	<b>1493</b>
<b>1.1 General principles.....</b>	<b>1493</b>
<b>1.2 Legal effect.....</b>	<b>1493</b>
<b>1.3 Formal requirements.....</b>	<b>1494</b>
1.3.1 Form and language.....	1494
1.3.2 Fees.....	1494
1.3.3 Necessary particulars.....	1495
1.3.4 Partial surrender.....	1495
1.3.5 Signature.....	1495
1.3.6 Representation.....	1495
1.3.7 Requirements where a licence or other right in the EUTM has been registered.....	1496
<b>1.4 Examination.....</b>	<b>1497</b>
1.4.1 Competence.....	1497
<b>2 Alteration of a Trade Mark.....</b>	<b>1497</b>
<b>2.1 General principles.....</b>	<b>1497</b>
<b>2.2 Formal requirements.....</b>	<b>1498</b>
2.2.1 Form and language.....	1498
2.2.2 Fees.....	1498
2.2.3 Mandatory indications.....	1498
<b>2.3 Substantive conditions for alteration.....</b>	<b>1499</b>
2.3.1 Examples of acceptable alterations.....	1499
2.3.2 Examples of unacceptable alterations.....	1500
<b>2.4 Publication.....</b>	<b>1501</b>
<b>3 Changes of Name or Address.....</b>	<b>1501</b>
<b>4 Changes in Collective and Certification Trade Mark Regulations.....</b>	<b>1502</b>
<b>4.1 Registration of the amended regulations.....</b>	<b>1503</b>
<b>5 Division.....</b>	<b>1504</b>
<b>5.1 General provisions.....</b>	<b>1504</b>
<b>5.2 Formal requirements.....</b>	<b>1504</b>
5.2.1 Form and language.....	1504
5.2.2 Fees.....	1505

5.2.3 Mandatory indications.....	1505
<b>5.3 Registration.....</b>	<b>1506</b>
<b>5.4 New file, publication.....</b>	<b>1507</b>
<b>6 Post-Registration Seniority Claims.....</b>	<b>1507</b>
<b>6.1 General principles.....</b>	<b>1507</b>
<b>6.2 Legal effect.....</b>	<b>1507</b>
<b>6.3 Formal requirements.....</b>	<b>1508</b>
6.3.1 Form and language.....	1508
6.3.2 Fees.....	1508
6.3.3 Mandatory indications.....	1508
<b>6.4 Examination.....</b>	<b>1508</b>
<b>6.5 Registration and publication.....</b>	<b>1509</b>
<b>6.6 Cancellation of seniority claims.....</b>	<b>1509</b>
<b>7 Replacement of an EUTM Registration by an IR.....</b>	<b>1509</b>

## 1 Surrender

[Article 57 EUTMR](#)

[Article 15 EUTMIR](#)

### 1.1 General principles

At any time after registration, a European Union trade mark (EUTM) may be surrendered by its proprietor in respect of some or all of the goods and services. The surrender must be declared to the Office in writing. (For information on the withdrawal of EUTM applications, that is, prior to registration, see [the Guidelines, Part B, Examination, Section 1, Proceedings, paragraph 5.1.](#))

### 1.2 Legal effect

[Article 57\(2\) EUTMR](#)

[Article 15 EUTMIR](#)

Surrenders only become legally effective on the date of entry in the EUTM Register. The registration procedure for the surrender may be suspended during ongoing proceedings (see [paragraph 1.4](#) below).

The proprietor's rights in the registered EUTM, as well as those of its licensees and any other holders of rights in the mark, lapse with an *ex nunc* effect on the date of the registration of the surrender in the EUTM Register. Therefore, the surrender has no retroactive effect.

The surrender has procedural and substantive effects.

In procedural terms, when the surrender is entered in the EUTM Register, the EUTM ceases to exist and any proceedings (with the exception of invalidity or revocation proceedings) involving the mark before the Office terminate.

The substantive effects of surrender vis-à-vis third parties comprise the EUTM proprietor renouncing any rights arising from its mark in the future.

The EUTM proprietor is bound by the declaration of surrender during its registration procedure, provided that the following circumstances are present.

1. No revocation of the declaration reaches the Office on the same day as the receipt of the declaration of surrender. That means that if a declaration of surrender and a communication revoking that declaration reach the Office on the same day (regardless of the hour and minute of their receipt), they cancel each other out. Once it becomes effective, the declaration may not be revoked.

2. The declaration meets all the formal requirements, in particular those identified in [paragraph 1.3.7](#) below.

### 1.3 Formal requirements

#### 1.3.1 Form and language

[Article 146\(2\) and \(6\) EUTMR](#)

[Article 17\(7\)](#) and [Article 65 EUTMDR](#)

[Article 24 EUTMIR](#)

The proprietor must declare the surrender to the Office in writing. The general rules for communication with the Office apply (see [the Guidelines, Part A, General Rules, Section 1, Means of Communication, Time Limits](#)).

The declaration of surrender must be submitted in writing in one of the five languages of the Office, namely, English, French, German, Italian or Spanish.

However, when the declaration of surrender is filed using the form provided by the Office pursuant to [Article 65 EUTMDR](#), the form may, according to [Article 146\(6\) EUTMR](#), be used in any of the official languages of the European Union, provided that the form is completed in one of the languages of the Office, as far as textual elements are concerned.

Where there is an application for revocation or for a declaration of invalidity pending against an EUTM, and the proprietor wishes to surrender the contested EUTM, it must do so by way of a separate document. For more information on the separate document requirement, see [the Guidelines, Part C, Opposition, Section 1, Opposition Proceedings, paragraph 4.4.1](#).

The declaration of surrender is void where it contains conditions or time limitations. For example, it may not be made under the condition that the Office takes a particular decision or, in *inter partes* proceedings, that the other party makes a procedural declaration. For instance, during cancellation proceedings the mark may not be (partially) surrendered on the condition that the cancellation applicant withdraws its cancellation action. However, this does not exclude the possibility of an agreement between the parties, or prevent both parties from requesting successive actions (for example, surrender of the trade mark and withdrawal of the cancellation action) in the same communication to the Office.

#### 1.3.2 Fees

There is no fee for a declaration of surrender.

### 1.3.3 Necessary particulars

#### Article 15 EUTMIR

The declaration of surrender must contain the particulars referred to in [Article 15 EUTMIR](#). These are:

- the EUTM registration number;
- the EUTM proprietor's name and address or the proprietor's Office ID number together with the proprietor's name;
- where the surrender is only for some of the goods or services for which the mark is registered, either the goods and services for which the surrender is declared or an indication of the goods and services for which the mark is to remain registered or both (see [paragraph 1.3.4](#) below).

### 1.3.4 Partial surrender

An EUTM may be surrendered in part, that is, for some of the goods and services for which it is registered. A partial surrender only becomes effective on the date it is entered in the EUTM Register.

For a partial surrender to be accepted, the following two conditions relating to the goods and services must be met:

1. the new wording must not constitute an extension of the list of goods and services;
2. the partial surrender must constitute a valid description of goods and services.

For further details on acceptable restrictions and for the practice regarding the declaration referred to in [Article 33\(8\) EUTMR](#), see [the Guidelines, Part B, Examination, Section 3, Classification](#).

### 1.3.5 Signature

Except where [Article 63\(1\)\(a\) EUTMDR](#) allows otherwise, the declaration of surrender must be signed by the EUTM proprietor or its duly appointed representative.

### 1.3.6 Representation

#### Articles [119\(2\)](#) and [120\(1\)](#) EUTMR

The general rules apply (see [the Guidelines, Part A, General Rules, Section 5, Professional Representation](#)).

### 1.3.7 Requirements where a licence or other right in the EUTM has been registered

A surrender cannot be registered if third parties have registered rights in the EUTM (such as licensees, pledgees, etc.) without first fulfilling certain additional requirements.

Where a licence, or another right in the EUTM, is entered in the EUTM Register, the following additional requirements apply.

1. The EUTM proprietor must submit sufficient proof that it has informed the licensee, pledgee, etc. of its intention to surrender.

If the proprietor proves to the Office that the licensee, pledgee, etc. has given its **consent** to the surrender, the surrender will be registered upon receipt of that notice.

If the EUTM proprietor merely submits proof that it has **informed** the licensee/pledgee of its intention to surrender, the Office will inform the proprietor that the surrender will be registered 3 months after the date on which the Office received the evidence ([Article 57\(3\) EUTMR](#)).

The Office will consider a copy of the communication from the proprietor to the licensee/pledgee as sufficient evidence. The same applies to a written statement signed by the licensee/pledgee that it has been informed. An affidavit by the proprietor is not necessary. The term ‘proves’ in [Article 57\(3\) EUTMR](#) does not refer to absolute certainty but to a reasonable probability, as follows from the other language versions of the Regulations ([Article 57\(3\) EUTMR](#): Italian version: *dimostra*, German version: *glaubhaft macht*). The documents may be in any of the 23 official languages of the European Union. However, the Office may require a translation into the language chosen for the declaration of surrender or, at the choice of the declarant, into any of the five languages of the Office.

If no proof has been provided or it is insufficient, the Office will request that it be submitted within 2 months.

2. Where a levy of execution is entered in the EUTM Register, the declaration of surrender must be accompanied by a declaration of consent to the surrender signed by the authority competent for the levy of execution (see [the Guidelines, Part E, Register Operations, Section 3, EUTMs and RCDs as Objects of Property, Chapter 2, Licences, Rights in Rem, Levies of Execution, Insolvency Proceedings, Entitlement Proceedings or Similar Proceedings](#)).
3. Where insolvency or similar proceedings are entered in the EUTM Register, the declaration of surrender must be requested by the liquidator (see [the Guidelines, Part E, Register Operations, Section 3, EUTMs and RCDs as Objects of Property, Chapter 2, Licences, Rights in Rem, Levies of Execution, Insolvency Proceedings, Entitlement Proceedings or Similar Proceedings](#)).

## 1.4 Examination

[Article 57\(2\) EUTMR](#)

[Article 17\(4\), \(5\) and \(6\) EUTMDR](#)

### 1.4.1 Competence

Where surrender (or a partial surrender) is declared during ongoing revocation or invalidity proceedings against the validity of the EUTM that is being surrendered, the Office will suspend the registration of the surrender and invite the cancellation applicant to indicate whether it wishes to continue with the proceedings. For details concerning the treatment of surrenders received during the course of open cancellation proceedings, see [the Guidelines, Part D, Cancellation, Section 1, Cancellation Proceedings, paragraph 4.3.1](#).

Where the EUTM is subject to a case pending before the General Court or the Court of Justice, the surrender must be filed at the Office (not before the General Court or the Court of Justice). The Office will then inform the General Court or the Court of Justice whether or not it finds the surrender acceptable and valid.

## 2 Alteration of a Trade Mark

### 2.1 General principles

[Article 54 EUTMR](#)

[Article 10 EUTMIR](#)

This section of the Guidelines and the provisions cited above deal solely with alterations of the EUTM that are requested by the proprietor of its own accord.

There is a difference between an amendment of an EUTM application and an alteration of a registered EUTM. The amendment of an EUTM application is governed by [Article 49 EUTMR](#) and [Article 11 EUTMDR](#). The alteration of a registered EUTM is governed by [Article 54 EUTMR](#) and [Article 10 EUTMIR](#) (for more information on amendments of an EUTM application, see [the Guidelines, Part B, Examination, Section 2, Formalities](#)).

This section does not apply to corrections of obvious errors by the Office in its publications or in the EUTM Register; such corrections are made *ex officio*, or at the proprietor's request, pursuant to [Article 44\(3\)](#) and [Article 102 EUTMR](#) (for more information, see [the Guidelines, Part A, General Rules, Section 6, Revocation of Decisions, Cancellation of Entries in the Register and Correction of Errors](#)).



The alteration of a mark enables the representation of a mark to be altered, providing the alteration relates to the proprietor's name and/or address **and** does not substantially affect the identity of the trade mark as originally registered.

The Regulations do not provide for the possibility of altering other elements of the EUTM registration.

## 2.2 Formal requirements

### 2.2.1 Form and language

[Article 54](#) and [Article 146\(6\) EUTMR](#)

The application to alter the mark, that is, the representation of the mark, must be submitted in writing in one of the five languages of the Office, namely, English, French, German, Italian or Spanish.

However, when the application for the registration of an alteration of the mark is filed using the form provided by the Office pursuant to [Article 65 EUTMDR](#), the form may, according to [Article 146\(6\) EUTMR](#), be used in any of the official languages of the European Union, provided that the form is completed in one of the languages of the Office, as far as textual elements are concerned.

### 2.2.2 Fees

[Article 54\(4\)](#) and [Annex I A\(28\) EUTMR](#)

The application to alter the mark is considered not to have been filed until the fee has been paid. The amount of this fee is EUR 200 (see [the Guidelines, Part A, General Rules, Section 3, Payment of Fees, Costs and Charges](#)).

### 2.2.3 Mandatory indications

[Article 54\(3\) EUTMR](#)

[Article 10 EUTMIR](#)

The application for alteration must contain:

- the EUTM registration number;
- the EUTM proprietor's name and address in accordance with [Article 2\(1\)\(b\) EUTMIR](#), or the proprietor's Office ID number together with the proprietor's name;
- an indication of the element in the representation of the mark to be altered and the altered version of the element;
- a representation of the mark as altered that complies with the formal requirements laid down in [Article 3 EUTMIR](#).

## 2.3 Substantive conditions for alteration

[Article 54\(2\) EUTMR](#) allows the alteration of the representation of the mark only under very limited conditions, namely only when:



- the EUTM includes the EUTM proprietor’s name and/or address, **and**
- these are the elements for which alteration is sought, **and**
- the alteration would not substantially affect the identity of the trade mark as originally registered.



Strict rules apply: where the proprietor’s name or address is part of the distinctive elements of the mark, for example, part of a word mark, an alteration is in principle excluded since the identity of the mark would be substantially affected. A mark may be altered if the EUTM proprietor’s name or address appears on a figurative mark, for example, the label of a bottle, as a subordinate element in small letters. Such elements would normally not be taken into account in determining the scope of protection or the fulfilment of the use requirement. The rationale of [Article 54\(2\) EUTMR](#) is precisely to exclude any alteration of the registered EUTM that could affect its scope of protection or the assessment of the use requirement, so that rights of third parties cannot be affected.

No other element of the mark may be altered, not even if it is only a subordinate element in small letters of a descriptive nature, such as the indication of the percentage of alcohol on a label of a bottle of wine.

Furthermore, [Article 54\(2\) EUTMR](#) does not allow for the alteration of the list of goods and services (09/07/2008, [R 585/2008-2](#), SAGA, § 16). After registration, the only way to change the list of goods and services is through partial surrender under [Article 57 EUTMR](#) (see [paragraph 1.3.4](#) above).

### 2.3.1 Examples of acceptable alterations

Mark as registered	Proposed alteration
<p>EUTM No 7 389 687</p> 	

Mark as registered	Proposed alteration
<p>EUTM No 4 988 556</p> 	

### 2.3.2 Examples of unacceptable alterations

Mark as registered	Proposed alteration
<p>EUTM No 11 058 823</p> <p>ROTAM — INNOVATION IN POST PATENT TECHNOLOGY'</p>	<p>ROTAM — INNOVATION IN POST PATENT TECHNOLOGY</p>
<p>EUTM No 9 755 307</p> <p><b>MINADI MINADI Occhiali</b></p>	<p>MINADI</p>
<p>EUTM No 10 009 595</p> <p>CHATEAU DE LA TOUR SAINT-ANNE</p>	<p>CHATEAU DE LA TOUR SAINTE-ANNE</p>
<p>EUTM No 9 436 072</p> <p>SLITONE ULTRA</p>	<p>SLITONEULTRA</p>
<p>EUTM No 2 701 845</p> 	
<p>EUTM No 3 115 532</p> 	

Mark as registered	Proposed alteration
EUTM No 7 087 943 	
EUTM No 8 588 329 	

## 2.4 Publication

Where the alteration of the registration is allowable, it will be registered and published. The publication will contain a representation of the EUTM as altered.

Within 3 months of the publication of the alteration ([Article 54\(5\) EUTMR](#)), third parties whose rights may be affected by the alteration may challenge the registration thereof. For this procedure, the provisions on the opposition procedure apply *mutatis mutandis*.

## 3 Changes of Name or Address

Articles [55](#) and [111](#) and [Article 146\(6\) EUTMR](#)

[Article 12\(a\), \(b\) and \(c\) EUTMIR](#)

Both registered European Union trade marks (EUTMs) and EUTM applications may be the subject of changes of name and address. Unless otherwise provided, the practice applicable to EUTMs is also applicable to EUTM applications.

It is possible to change the name, address or nationality of the proprietor of a registered EUTM or its representative. The application to register the change must be submitted in one of the five languages of the Office, namely, English, French, German, Italian or Spanish. The change will be entered in the EUTM Register and published.

Pursuant to [Article 12 EUTMIR](#), the name, including the indication of the legal form, and address of the proprietor or representative may be amended freely, provided that:

- as regards the proprietor's name, the change is not the consequence of a transfer;

- as regards the representative's name, there is no substitution of one representative by another.

Pursuant to [Article 111\(3\)\(a\) EUTMR](#), the indication of the nationality or the State of establishment of a legal person may also be altered or added, provided that it is not the consequence of a transfer.

A change of the proprietor's name within the sense of [Article 12 EUTMIR](#) is a change that does not affect the ownership, whereas a transfer is a change from one proprietor to another. In case of doubt as to whether the change falls under [Article 20 EUTMR](#), see [the Guidelines, Part E, Register Operations, Section 3, EUTMs and RCDs as Objects of Property, Chapter 1, Transfer](#), for details and the applicable procedure.

Likewise, a change of a representative's name within the sense of [Article 55\(4\) EUTMR](#) and [Article 12 EUTMIR](#) is limited to a change that does not affect the identity of the appointed representative; for example, where the name changes as a result of marriage. [Article 55\(4\) EUTMR](#) and [Article 12 EUTMIR](#) also apply where the name of an association of representatives changes. Such a change of name must be distinguished from the substitution of one representative by another, which is subject to the rules governing the appointment of representatives. For details, see [the Guidelines, Part A, General Rules, Section 5, Professional Representation](#).

To register a change of name and address, the proprietor must submit an application to the Office. The application must contain the EUTM number as well as the name and address of the proprietor ([Article 2\(1\)\(b\) EUTMIR](#)) or of the representative ([Article 2\(1\)\(e\) EUTMIR](#)), both as registered in the file and as amended.

Normally no proof or evidence of the change is necessary. However, in case of doubt, the examiner may ask for proof such as a certificate from a trade register. The application to register the change of name or address is not subject to a fee.

Legal persons may only have one official address. In case of doubt, the examiner may ask for evidence of the legal form or of the address in particular. The official name and address are also used as the address for service by default. A proprietor should have only one address for service. In order to ensure the veracity and correctness of the Register, a change in the proprietor's official name or official address will be registered for all EUTMs, RCDs and pending proceedings of this entity in the name of that proprietor. Unlike the address for service, a change in the official name or address cannot be registered solely for specific portfolios of rights. These rules apply to representatives by analogy.

## 4 Changes in Collective and Certification Trade Mark Regulations

Articles [79](#) and [88](#) and [Article 146\(6\) EUTMR](#)

According to Articles [79](#) and [88](#) EUTMR, the proprietors of EU collective and certification marks must submit to the Office any amended regulations governing use.

The application to enter in the EUTM Register an amendment of the regulations governing the use of a collective or certification trade mark must be submitted in writing in one of the five languages of the Office, namely, English, French, German, Italian or Spanish.

#### 4.1 Registration of the amended regulations

[Article 75\(2\)](#), Articles [76](#) and [77](#), [Article 79\(3\) and \(4\)](#) and Articles [84](#), [85](#) and [88](#) and [111](#) EUTMR

The amendment of the regulations governing the use of a collective or certification trade mark will not be entered in the EUTM Register if the amended regulations do not satisfy the requirements of [Article 75\(2\)](#) or [Article 84 EUTMR](#), or if they involve one of the grounds for refusal referred to in Article [76](#) or [85](#) EUTMR.

Where the registration of the amendment of the regulations is accepted, it will be registered and published.

The applicant for the amendment will specify the part of the amended regulations to be entered in the EUTM Register, which can be as follows.

##### **For collective marks:**

- the EUTM proprietor's name and address;
- the purpose of the association or the purpose for which the legal person governed by public law is constituted;
- the bodies authorised to represent the association or the legal person;
- the conditions for membership;
- the persons authorised to use the mark;
- where appropriate, the conditions governing use of the mark, including sanctions;
- if the mark designates the geographical origin of goods or services, authorisation for any person whose goods or services originate in the geographical area concerned to become a member of the association.

##### **For certification marks:**

- the EUTM proprietor's name and address;
- a declaration that the proprietor complies with the requirements laid down in [Article 83\(2\) EUTMR](#);
- the characteristics of the goods or services to be certified by the EU certification mark, such as the material, mode of manufacture of goods or performance of services, quality or accuracy;
- the conditions governing the use of the EU certification mark, including sanctions;
- the persons authorised to use the EU certification mark;
- how the certifying body is to test those characteristics and to supervise the use of the EU certification mark.

Within 3 months of the publication of the amended regulations, third parties whose rights may be affected by the amendment may challenge the registration thereof. For this procedure, the provisions on third party observations apply *mutatis mutandis*.

## 5 Division

### 5.1 General provisions

[Article 56](#) and [Annex I A\(25\) EUTMR](#)

[Article 11 EUTMIR](#)

A registration can be split into different parts not only as the result of a partial transfer (see [the Guidelines, Part E, Register Operations, Section 3, EUTMs and RCDs as Objects of Property, Chapter 1, Transfer](#)), but also on the EUTM proprietor's own motion. A division of a trade mark is particularly useful in order to isolate a disputed trade mark for certain goods or services and maintain the registration for the remainder. For information on the division of EUTM applications, see [the Guidelines, Part B, Examination, Section 1, Proceedings](#).

Whereas a partial transfer is free of charge and involves a change of ownership, the declaration of division of a trade mark is subject to a fee and the trade mark remains in the hands of the same proprietor. If the fee has not been paid, the declaration of division is considered not to have been filed. The declaration must be made in one of the five languages of the Office.

For information on the division of international registrations designating the EU under the Madrid Protocol, please see [the Guidelines, Part M, International Marks, paragraph 5, Division](#).

### 5.2 Formal requirements

#### 5.2.1 Form and language

[Article 146\(6\) EUTMR](#)

A declaration of division of an EUTM must be submitted in writing in one of the five languages of the Office namely, English, French, German, Italian or Spanish.

However, when the declaration of division of an EUTM is filed using the form provided by the Office pursuant to [Article 65 EUTMDR](#), the form may be used in any of the official languages of the European Union, provided that the form is completed in one of the languages of the Office, as far as textual elements are concerned.

## 5.2.2 Fees

### [Annex I A\(25\) EUTMR](#)

The declaration is subject to a fee of EUR 250; the declaration is considered not to have been filed until the fee has been paid (see [the Guidelines, Part A, General Rules, Section 3, Payment of Fees, Costs and Charges](#)).

## 5.2.3 Mandatory indications

### [Article 54\(4\)](#) and [Article 56 EUTMR](#)

### [Article 11 EUTMIR](#)

The declaration of division must contain:

- the registration number of the EUTM to be divided;
- the proprietor's name and address; if the proprietor has previously been allocated an ID number by the Office, it is sufficient to indicate that ID number together with the proprietor's name;
- the list of goods and services for the divisional registration, or, if more than one new registration is to be created, for each divisional registration;
- the list of goods and services that will remain in the original EUTM.

The goods and services must be distributed between the original EUTM and the new EUTM so that the goods and services in the original and the new EUTM do not overlap. The two specifications taken together must not be broader than the original specification. Goods or services that have been objected to or contested (e.g. absolute grounds examination, contested in opposition proceedings, etc.) should remain in the original EUTM. Only those goods and services that are neither contested nor objected to may be split and placed within the new EUTM.

Therefore, the indications must be clear, precise and unequivocal. For example, when an EUTM for goods or services in several classes is involved, and the 'split' between the old and new registration concerns whole classes, it is sufficient to indicate the respective classes for the new registration or for the remaining one.

When the declaration of division indicates goods and services that are explicitly mentioned in the original list of goods and services, the Office will automatically keep the goods and services that are not mentioned in the declaration of division in the original EUTM. For example, the original list contains goods A, B, and C and the declaration of division relates to C; the Office will keep goods A and B in the original registration and create a new registration for C.

For the assessment of whether there is a limitation or a broadening of scope of the list, the rules generally applicable in such situations apply (see [the Guidelines, Part B, Examination, Section 3, Classification](#)).



In all cases it is highly recommended to submit a clear and precise list of goods and services to be divided, together with a clear and precise list of goods and services to remain in the original registration. Furthermore, the original list must be clarified. For example, if the original list related to *alcoholic beverages* and the division relates to *whisky* and *gin*, the original list must be amended by restricting it to *alcoholic beverages, except whisky and gin*.

There are also certain periods during which, for procedural economy or to safeguard third-party rights, a declaration of division is not admissible. These periods are prescribed by [Article 56\(2\) EUTM](#) and are as follows.

- While cancellation proceedings are pending before the Office (application for revocation or declaration of invalidity), only those goods and services against which the cancellation request is not directed may be divided from the original EUTM. The Office interprets [Article 56\(2\)\(a\) EUTMR](#) as not only excluding a division where some of the contested goods are divided from the original EUTM, with the effect that the cancellation proceedings would have to be split, but also as excluding the division of all the contested goods from the original EUTM. However, in this case, the EUTM proprietor will be given the opportunity to amend the declaration of division by dividing the other goods and services from the original EUTM, that is, those that are not contested in the cancellation proceedings.
- While proceedings are pending before the Boards of Appeal, the General Court or the Court of Justice, only those goods and services not affected by those proceedings may be divided from the original EUTM, due to the suspensive effect of the proceedings.
- Likewise, while a counterclaim for revocation or declaration of invalidity is pending before an EUTM court, the same conditions apply. This covers the period starting on the day the counterclaim was lodged before the EUTM court and ending on the date on which the Office records the EUTM court's judgment in the EUTM Register pursuant to [Article 128\(6\) EUTMR](#).

### 5.3 Registration

[Article 56\(5\), \(6\) and \(7\) EUTMR](#)

If the Office accepts the declaration of division, a new registration is created as of that date and not retroactively from the date of the declaration.

The new registration keeps the filing date and, depending on the goods and services, any priority or seniority dates; the seniority effect may become partial.

All requests and applications submitted and all fees paid prior to the date on which the Office receives the declaration of division are also deemed to have been made or paid for the resulting divisional registration. However, fees duly paid for the original registration will not be refunded. The practical effects of this provision can be illustrated by the following examples.

- Where an application for the registration of a licence was submitted and the payment of the fee for its registration was received by the Office prior to the declaration of division, the licence will be registered in the EUTM Register for both the original and the divisional EUTM if the licence covers goods and/or services in the original and divisional EUTM. No further fees need to be paid.
- Where an EUTM registration containing two classes is to be divided into two registrations, no additional class fees for the renewal are payable as from **the date on which the division is entered in the EUTM Register** but, instead, two basic renewal fees will be payable, one for each registration.

## 5.4 New file, publication

### [Article 111\(3\) EUTMR](#)

A new file must be created for the divisional registration. It must contain all the documents that were on file for the original registration, plus all the correspondence related to the declaration of division, as well as all correspondence for the new registration.

The division will be published in the EUTM Bulletin.

## 6 Post-Registration Seniority Claims

### [Article 40 EUTMR](#)

Decision No [EX-17-3](#) of the Executive Director of the Office of 18/09/2017

### 6.1 General principles

The proprietor of an earlier trade mark registered in a Member State, including a trade mark registered under international arrangements having effect in a Member State, that holds an identical EUTM for goods or services that are identical with or contained in those for which the earlier trade mark has been registered, may claim for the EUTM the seniority of the earlier trade mark in respect of the Member State in or for which it is registered.

Seniority may be claimed at any time after the registration of the EUTM.

### 6.2 Legal effect

Concerning the legal effects of a seniority claim, see [the Guidelines, Part B, Examination, Section 2, Formalities, paragraph 13](#), which applies by analogy to post-registration seniority claims.

## 6.3 Formal requirements

### 6.3.1 Form and language

[Article 40](#) and [Article 146\(6\) EUTMR](#)

The seniority claim must be declared to the Office in writing and must be submitted in one of the five languages of the Office namely, English, French, German, Italian or Spanish.

However, when the seniority claim is filed using the form provided by the Office pursuant to [Article 65 EUTMDR](#), the form may be used in any of the official languages of the European Union, provided that the form is completed in one of the languages of the Office, as far as textual elements are concerned.

### 6.3.2 Fees

There is no fee for an application for a seniority claim.

### 6.3.3 Mandatory indications

[Article 40 EUTMR](#)

Decision No [EX-17-3](#) of the Executive Director of the Office of 18/09/2017

A valid claim must contain the indications as listed in [paragraph 13.2 of the Guidelines, Part B, Examination, Section 2, Formalities](#), which applies equally to post-registration seniority claims.

## 6.4 Examination

Seniority may only be claimed from an earlier **registration**, not an earlier application. The date of the earlier trade mark must be before the respective dates of the EUTM (filing date or, if available, priority date).

For details of the examination of seniority claims, the triple identity requirements and examples of acceptable and unacceptable seniority claims, see [the Guidelines, Part B, Examination, Section 2, Formalities, paragraphs 13.2, 13.3, 13.4 and 13.6](#), which apply equally to post-registration seniority claims.

If the claim to seniority does not satisfy the formal requirements or if the marks are not identical, the Office will notify the proprietor and give it 2 months to remedy the deficiency or submit observations.

If the deficiency is not remedied, the Office will inform the proprietor that the right to claim seniority has been rejected.

## 6.5 Registration and publication

Articles [39\(5\)](#) and [40\(4\)](#) and [Article 111\(3\)\(f\) EUTMR](#)

If the claim to seniority is acceptable, the Office will register it and inform the central industrial property office(s) of the Member State(s) concerned.

The seniority claim will be published in the EUTM Bulletin.

## 6.6 Cancellation of seniority claims

The EUTM proprietor may at any time request cancellation of the seniority claim from the EUTM Register of its own motion.

Seniority claims may also be cancelled by a decision of a national court (see [Article 6 Directive \(EU\) 2015/2436](#)).

The cancellation of the seniority claim will be published in the EUTM Bulletin. [Article 111\(3\)\(f\) EUTMR](#) provides that the cancellation of seniority will be registered.

## 7 Replacement of an EUTM Registration by an IR

[Article 111\(3\)\(t\)](#) and [Article 197 EUTMR](#)

Article *4bis* Madrid Protocol

Rule 21 Regulations under the Protocol

In accordance with Article *4bis* of the Madrid Agreement and Protocol, the holder of an international registration designating the European Union (IR) may request the Office to take note in its Register that an EUTM registration is replaced by a corresponding IR. The holder's rights in the European Union will be considered to start from the date of the earlier EUTM registration. Therefore, the Office will enter in the EUTM Register that an EUTM has been replaced by a designation of the EU through an IR, and that entry will be published in the EUTM Bulletin.

For more information on replacement, see the Guidelines, [Part M, International Marks](#).

***GUIDELINES FOR EXAMINATION OF  
EUROPEAN UNION TRADE MARKS***

***EUROPEAN UNION  
INTELLECTUAL PROPERTY OFFICE  
(EUIPO)***

***Part E***

***Register operations***

***Section 2***

***Conversion***

## Table of Contents

<b>1 Introduction.....</b>	<b>1512</b>
<b>2 Conversion of EUTMs and IRs Designating the EU.....</b>	<b>1513</b>
2.1 Conversion of EUTMs.....	1513
2.2 Conversion of IRs designating the EU.....	1513
<b>3 Valid EUTM Application as a Condition for Conversion.....</b>	<b>1515</b>
<b>4 Grounds Precluding Conversion.....</b>	<b>1515</b>
4.1 Revocation on the grounds of non-use.....	1516
4.2 Ground for refusal limited to a Member State or extended to the entire EU.....	1516
4.3 Withdrawal/surrender after a decision has been rendered.....	1517
4.4 Competence to decide on grounds precluding conversion.....	1518
<b>5 Formal Requirements for the Request for Conversion.....</b>	<b>1518</b>
5.1 Time limit.....	1518
5.1.1 Start of time limit where the Office issues a notification.....	1519
5.1.2 Start of time limit in other cases.....	1519
5.2 Request for conversion.....	1520
5.3 Language.....	1522
5.4 Fees.....	1522
<b>6 Examination by the Office.....</b>	<b>1523</b>
6.1 Stages of the procedure – competence.....	1523
6.2 Publication of the request and entry in the Register.....	1523
6.3 Examination.....	1524
6.3.1 Fees.....	1524
6.3.2 Time limit.....	1524
6.3.3 Language.....	1524
6.3.4 Formalities.....	1525
6.3.5 Grounds.....	1525
6.3.6 Representation.....	1526
6.3.7 Partial conversion.....	1526
6.4 Transmission to designated offices.....	1527
<b>7 Effects of Conversion.....</b>	<b>1528</b>

## 1 Introduction

Conversion is the process of turning a European Union trade mark (EUTM) application or registration into one or more national applications. Its main features are laid down in Articles [139 to 141](#) EUTMR and Articles [22](#) and [23](#) EUTMIR. If an EUTM ceases to exist, it can, depending on the specific reason for this, be converted into trade marks that are valid in certain Member States. Conversion is particularly useful for overcoming possible problems with the EUTM's unitary character. For example, if the EUTM faces a registrability problem in only one or several countries on absolute grounds or due to an opposition based on an earlier right valid in only one country or several countries, the EUTM applicant can apply to convert the EUTM into individual, national trade mark applications in the countries not affected by these grounds.

The EUTM system is based on the principle that the European Union and national trade mark systems are complementary. They are notably linked to each other by the seniority and conversion procedures. The system is construed in such a way that the earlier filing date of a registered right will always prevail in the territory in which it is valid, irrespective of whether the registered trade mark results from a national filing, an international designation or an EUTM application (15/07/2008, [R 1313/2006-G](#), CARDIVA (fig.) / CARDIMA (fig.); 22/09/2008, [R 207/2007-2](#), RESTORIA / RESTORIA, § 34).

Conversion is a two-tier system involving, firstly, the payment of the conversion fee and the examination of the request for conversion before the Office and, secondly, the conversion procedure itself before the national offices. Depending on national law, the converted trade mark will either be registered immediately or enter the national examination, registration and opposition procedures in the same way as a normal national trade mark application.

Where the EU is designated in an international registration (IR) and to the extent that the designation has been withdrawn, refused or has ceased to have effect, a request may also be made for conversion into national trade mark applications in one, several or all of the Member States, or through a subsequent designation of the Member States under the Madrid System.

Conversion of IRs designating the EU is not to be confused with 'transformation', which is a legal feature introduced by the Madrid Protocol (MP) in order to soften the consequences of the five-year dependency period and central attack (ceasing of effect of the basic mark) existing under the Madrid Agreement (see Article 6(3) MP). Transformation allows for a centrally attacked international mark to be transformed into a direct EUTM application, but does not allow for the conversion of an EU designation into national filings. For more information on transformation, see [the Guidelines, Part M, International marks](#).

## 2 Conversion of EUTMs and IRs Designating the EU

### 2.1 Conversion of EUTMs

Articles [139\(1\)](#) and [140\(1\)](#) and [Article 159 EUTMR](#)

[Article 22\(e\), \(f\)](#) and [Article 35\(1\) EUTMR](#)

The applicant for an EUTM or proprietor of a registered EUTM may request the conversion of its EUTM application or registered EUTM. The request may be for conversion into national trade mark applications in one, several or all of the Member States. With regard to Belgium, Luxembourg and the Netherlands, the term 'national trade mark applications' includes Benelux trade mark applications, and 'national office', the Benelux Office for Intellectual Property (BOIP).

Conversion is possible in the following circumstances ('grounds for conversion'):

- where an EUTM application has been finally refused by the Office ([Article 139\(1\)\(a\) EUTMR](#)) in a decision on absolute or relative grounds for refusal during examination or opposition proceedings;
- where an EUTM application has been withdrawn by the applicant ([Article 49, Article 139\(1\)\(a\) EUTMR](#));
- where an EUTM application is considered to be withdrawn, namely when class fees have not been paid within the relevant time limit after filing the application ([Article 41\(5\), Article 139\(1\)\(a\) EUTMR](#));
- where an EUTM registration ceases to have effect ([Article 139\(1\)\(b\) EUTMR](#)), that is, in the following circumstances:
  - where an EUTM registration has been validly surrendered ([Article 57 EUTMR](#));
  - where an EUTM registration has not been renewed ([Article 53 EUTMR](#));
  - where an EUTM registration has been declared invalid by the Office or by a European Union trade mark court (Articles [62](#) and [128 EUTMR](#));
  - where the rights of the proprietor of an EUTM registration have been revoked by the Office or by an EUTM court ([Article 62 EUTMR](#)) — except in the case of revocation for non-use, unless the mark was genuinely used under the laws of the Member State for which conversion has been requested ([Article 139\(2\) EUTMR](#)) (see [paragraph 4.1](#) below).

### 2.2 Conversion of IRs designating the EU

The holder of an IR designating the EU may request the conversion of the designation of the EU:

- into national trade mark applications in one, several or all Member States;



- into subsequent designations of one or more Member States under the Madrid Protocol ('opting back'), provided that the Member State was a party to either Treaty, not only at the time of the request for conversion, but also on the date of the designation of the EU;
- into national trade mark applications for some Member States and subsequent designations for other Member States. The same Member State may only be selected once.

IR conversion is possible in the following circumstances ('grounds for conversion') where the designation of the EU in an IR ceases to have effect:

- where the effects of an IR designating the EU have been invalidated by the Office or an EUTM court ([Article 198 EUTMR](#), [Article 34 EUTMIR](#));
- where a limitation of the list of goods and services for the EU has been recorded in the International Register (Rule 25(1)(a)(ii), Rule 27(1) Regulations under the Protocol) (see [paragraph 6.2.7](#) and also the Guidelines, [Part M, International Marks, Section 3, The EUIPO as Designated Office, paragraph 3.8, Limitations of the list of goods and services](#))<sup>(88)</sup>;
- where a renunciation of the designation of the EU has been recorded in the International Register (Rule 25(1)(a)(iii), Rule 27(1) Regulations under the Protocol);
- where the Office is informed by WIPO that the IR has not been renewed for the EU, provided that the grace period for renewal is over (Rule 31(4)(b) Regulations under the Protocol);
- where an IR designating the EU has been finally refused by the Office ([Article 78\(5\)\(b\) and \(c\) EUTMDR](#), [Article 33\(2\)\(b\) and \(c\) EUTMIR](#));
- where the partial or total cancellation of the IR has been recorded in the International Register (Rule 25(1)(a)(v), Rule 27(1) Regulations under the Protocol);

Conversion may be requested for all or for some of the goods or services to which the abovementioned act or decision relates.

Where the abovementioned act or decision relates only to some of the goods and services for which the application was filed or registered, conversion may be requested only for those specific goods or services, or for a part of those goods or services.

'Opting back' may not be requested:

- where the cancellation of the IR has been recorded in the International Register, either totally or partially (Rule 25(1)(a)(v), Rule 27 Regulations under the Protocol). In this case, only national conversion is available for the goods and services affected by the cancellation;
- Where the IR has not been renewed for all the Contracting Parties designated, and the grace period for the renewal is over (Rule 31(4)(a) Regulations under the Protocol);
- where the IR has been cancelled because the basic application, the ensuing registration or the basic registration has ceased to have effect (Rule 22 Regulations

---

<sup>88</sup> Regulations under the Protocol Relating to the Madrid Agreement Concerning the International Registration of Marks (as in force on 01/02/2020).

under the Protocol); only transformation is available in such cases for the goods and services affected by the cancellation (Article 9<sup>quinquies</sup> MP).

### 3 Valid EUTM Application as a Condition for Conversion

[Article 139\(1\) EUTMR](#)

Where conversion is requested on the basis of an EUTM application, conversion is possible only if there is a valid EUTM application (see [the Guidelines, Part B, Examination, Section 2, Formalities](#)).

### 4 Grounds Precluding Conversion

[Article 93](#), Articles [139\(2\)](#), [140\(1\), \(3\) and \(4\)](#), and [202\(6\), \(7\) and \(9\)](#) EUTMR

Conversion will not take place in the following circumstances:

- in principle, where a registered EUTM or IR designating the EU has been revoked on the grounds of non-use (see [paragraph 4.1](#) below); or
- where the particular ground for which the EUTM application or registered EUTM or IR designating the EU has ceased to have effect would preclude registration of the same trade mark in the Member State concerned (see [paragraph 4.2](#) below). Therefore, a request for conversion of a rejected EUTM will not be admissible in respect of the Member State to which the grounds for refusal, invalidity or revocation apply; or
- without prejudice to [Article 139\(2\) EUTMR](#), where conversion relates to an application for an EU certification mark or to a registered EU certification mark, and the national law of the Member State concerned does not provide for the registration of guarantee or certification marks pursuant to [Article 28 of Directive \(EU\) 2015/2436](#) approximating the laws of the Member States relating to trade marks.

Even when the ground for conversion is the withdrawal of an application, if such a withdrawal takes place during the appeal period after a decision to refuse the mark on the basis of a ground that would preclude registration in the Member State concerned and if no appeal has been filed, the request for conversion will be rejected.

Even when the ground for conversion is the surrender of a registration, if such a surrender takes place during the appeal period after a decision to revoke an EUTM or IR on the grounds of non-use, or to refuse the mark on the basis of a ground that would preclude registration in the Member State concerned, and if no appeal has been filed, the request for conversion will be rejected (see [paragraph 4.3](#) below).

## 4.1 Revocation on the grounds of non-use

### [Article 139\(2\)\(a\) EUTMR](#)

The first reason for precluding conversion is when the rights of the EUTM proprietor or IR holder have been revoked on the grounds of non-use.

Conversion will not take place where the rights of the EUTM proprietor or of the IR holder have been revoked on the grounds of non-use, unless the EUTM or IR has been put to use that would be considered genuine use under the laws of the Member State for which conversion is requested.

No subsequent allegations by the applicant for conversion regarding the substance of the case will be allowed. For instance, if the EUTM was revoked for non-use, the applicant for conversion cannot plead before the Office that it is able to prove use in a particular Member State.

This is because the Office is not in a position to assess use of an EUTM based on the laws of the individual EU Member States.

However, [Article 139\(2\)\(a\) EUTMR](#) may apply when the owner of the revoked EUTM submits, together with a request for conversion, evidence from an official source, such as a national judgment, establishing genuine use of the mark pursuant to the laws of the Member State for which conversion is requested. However, conversion is allowed only if the following requirements are met:

- the representation of the trade mark in the evidence (e.g. national judgment) and the registered EUTM must be identical;
- the goods and services for which use was found at national level must be covered by the revoked EUTM (see also [paragraph 6.2.7](#) below);
- the relevant period of use in the revocation proceedings before the Office and the period for which use was established in the evidence (e.g. national judgment) must coincide or at least overlap to a certain extent.

## 4.2 Ground for refusal limited to a Member State or extended to the entire EU

### [Article 139\(2\)\(b\)](#) and [Article 140\(4\) EUTMR](#)

The second reason for precluding conversion is related to grounds for refusal, for revocation (other than non-use) or for a declaration of invalidity. It applies when the decision of the Office or of a European Union trade mark court expressly states that the ground for refusal, for revocation or for invalidity applies in respect of a particular Member State, and precludes conversion for that Member State (05/03/2009, [R 1619/2008-2](#), ORANGE (col.), § 23-24).

#### Examples

- Where an absolute ground for refusal exists only for one language, conversion will not take place in respect of the Member States where that language is an official language. For example, if an absolute ground for refusal was raised in relation to the English-speaking public, conversion would not take place in respect of Ireland and Malta (see [Article 140\(4\) EUTMR](#)).
- Where an absolute ground for refusal exists only for one Member State, which may be because the trade mark is descriptive or deceptive only in a particular Member State and not in other Member States (see [the Guidelines, Part B, Examination, Section 4, Absolute Grounds for Refusal](#)), conversion will not take place in respect of that Member State, but may be requested for all the Member States in which the ground for refusal has not been found to exist.
- Where an EUTM application or IR designating the EU has been refused in an opposition based on an earlier national trade mark in a specific Member State, conversion will not take place in respect of that Member State. When the opposition is based on a number of earlier rights from different Member States but the final decision rejects the EUTM application or the IR designating the EU on the basis of only **one** of those earlier rights, conversion may be requested for the remaining Member States. For example, if an opposition based on a French, an Italian, and an Irish national right is successful with regard to the Irish national right, and if there is no analysis of the other earlier rights, conversion will not take place for Ireland, but may take place for Italy and France (and all other Member States) (16/09/2004, [T-342/02](#), Moser Grupo Media, S.L., EU:T:2004:268; 11/05/2006, [T-194/05](#), Teletch International, EU:T:2006:124).
- According to [Article 140\(4\) EUTMR](#), applicable by analogy to IRs designating the EU in accordance with [Article 202\(8\) EUTMR](#), where an EUTM application has been refused or an EUTM registration has been declared invalid on relative grounds based on an earlier EUTM or another European Union industrial property right, this has the effect of excluding conversion for the entire European Union, even if likelihood of confusion exists only in part of it.

Where an EUTM or IR designating the EU has been declared invalid in invalidity proceedings on the grounds of [Article 59\(1\)\(b\) EUTMR](#) ('bad faith'), this has the effect of excluding conversion for the entire European Union.

### **4.3 Withdrawal/surrender after a decision has been rendered**

Where the applicant withdraws the EUTM application or the owner surrenders the EUTM, or where the holder renounces the designation of the EU before the decision becomes final (i.e. during the appeal period) and subsequently requests conversion of the mark into national trade marks in some or all of the Member States for which a ground for refusal, for revocation or invalidity applies, the request for conversion will be rejected for those Member States.

If the applicant, owner or holder files an appeal and subsequently withdraws or limits the refused application or surrenders, partially or totally, the invalidated or revoked EUTM or designation and then requests a conversion, the withdrawal, limitation or

surrender will be forwarded to the competent Board and may be put on hold pending the outcome of the appeal proceedings (24/03/2011, [C-552/09 P](#), TIMIKinderjoghurt, EU:C:2011:177, § 43; 22/10/2010, [R 463/2009-4](#), MAGENTA (col.), § 25-27; 07/08/2013, [R 2264/2012-2](#), SHAKEY'S). Only once the withdrawal, limitation or surrender has been processed will the conversion either be forwarded as admissible to all the Member States where conversion is requested, or refused, depending on the outcome of the assessment of the request (see also the Guidelines, [Part B, Examination, Section 1, Proceedings, paragraph 5.1](#), [Part D, Cancellation, Section 1, Cancellation proceedings, paragraph 4.3](#) and [Part E, Register operations, Section 1, Changes in a registration, paragraph 1](#)).

For information on the suspension of the registration of surrenders during cancellation proceedings, see the Guidelines, [Part D, Cancellation, Section 1, Cancellation proceedings, paragraph 4.3](#).

#### **4.4 Competence to decide on grounds precluding conversion**

[Article 140\(1\) and \(3\) EUTMR](#)

The Office will decide whether the request for conversion fulfils the conditions set out in the Regulations in conjunction with any final decisions (their operative part and reasons) that gave rise to the conversion.

If one of the grounds precluding conversion exists, the Office will refuse to forward the request for conversion to the respective national office or, in the case of an opting-back conversion, will refuse to forward the conversion to WIPO as a subsequent designation for the Member States for which conversion is precluded.

### **5 Formal Requirements for the Request for Conversion**

#### **5.1 Time limit**

A general time limit of three months applies for requesting conversion. The start of the time limit depends on the ground for conversion.

The time limit may not be extended.

Furthermore, the continuation of proceedings cannot be requested for this time limit ([Article 105\(2\) EUTMR](#)). However, *restitutio in integrum* is, in principle, possible.

### 5.1.1 Start of time limit where the Office issues a notification

#### [Article 139\(4\) EUTMR](#)

Where an EUTM application is considered to be withdrawn, a request for conversion may be filed within three months from the date of the corresponding notification from the Office.

The notification will be contained in the communication on the loss of rights.

### 5.1.2 Start of time limit in other cases

#### [Article 139\(5\) and \(6\) EUTMR](#)

In all other cases the time limit of three months for requesting conversion starts automatically, namely:

- where the EUTM application is withdrawn, on the day the withdrawal is received by the Office;
- where the EUTM is surrendered, on the day on which the surrender is entered in the EUTM Register, that is, the day on which it becomes effective pursuant to [Article 57\(2\) EUTMR](#);
- where protection of the IR has been limited or renounced with effect for the EU, on the day on which it is recorded by WIPO pursuant to Rule 27(1)(b) CR;
- where the EUTM registration was not renewed, on the day following the last day of the period within which a request for renewal may have been submitted pursuant to [Article 53\(3\) EUTMR](#), that is, six months after the expiry of the registration;
- where the IR was not renewed with effect for the EU, on the day following the last day on which renewal was still possible before WIPO, pursuant to Article 7(4) MP;
- where the EUTM application or IR designating the EU is rejected, on the day on which the decision becomes final;
- where the EUTM or IR designating the EU is declared invalid or revoked, on the day on which the decision of the Office or the judgment of the EUTM court becomes final.

A decision of the Office becomes final:

- when no appeal has been lodged, at the end of the two-month time limit for appeal pursuant to [Article 68 EUTMR](#);
- following a decision of the Boards of Appeal, at the end of the time limit for an appeal to the General Court, or, where applicable, with the final decision of the Court of Justice.

A decision of an EUTM court becomes final:

- when no appeal has been lodged, at the end of the time limit for appeal under national law;

- in all other cases, with the final decision of the EUTM court of final (second or third) instance.

For example, if an EUTM is rejected by a decision of the Office on absolute grounds for refusal that is **notified** on 11/11/2011, the decision becomes final on 11/01/2012. The three-month period for requesting conversion ends on 11/04/2012. Regarding subsidiary claims of acquired distinctiveness pursuant to Article 7(3) EUTMR and Article 2(2) EUTMIR, the deadline for conversion does not start to run until a decision on the subsidiary claim of acquired distinctiveness becomes final.

## 5.2 Request for conversion

[Article 140\(1\) EUTMR](#)

[Article 65\(2\)\(a\), \(b\) EUTMDR](#)

The request for conversion must be filed at the Office. The online form can be found on the Office's website at: <https://euipo.europa.eu/ohimportal/en/forms-and-filings>.

The 'Application for Conversion of an IR designating the EU' form can be found on the Office's website at: <https://euipo.europa.eu/ohimportal/en/international-application-forms>. This form may also be used for opting back. The Office will send the conversion data to WIPO in electronic format.

Using the forms made available by the Office enables it to extract the relevant information concerning the converted EUTM and the data concerning the applicant and representative from its database and to transmit them, together with the Conversion Form, to the designated offices.

[Article 140\(1\) EUTMR](#)

[Article 22 EUTMIR](#)

Applicants or their representatives must provide the following information ([Article 22 EUTMIR](#)).

- The name and address of the applicant for conversion, that is, the applicant or proprietor of the EUTM application or registration, or the holder of the IR;
- The filing number of the EUTM application or the registration number of the EUTM or of the IR;
- The indication of the ground on which conversion is requested:
  - where conversion is requested following the withdrawal of the application, the date of withdrawal must be indicated;
  - where conversion is requested following failure to renew the registration, the date on which protection expired must be indicated;
  - where conversion is requested following the surrender of an EUTM, the date on which it was entered in the Register must be indicated;

- where conversion is requested following a partial surrender, the goods or services for which the EUTM no longer has protection and the date on which the partial surrender was entered in the Register must be indicated;
  - where conversion is requested following a limitation, the goods or services for which the EUTM application no longer has protection and the date of limitation must be indicated;
  - where conversion is requested because the mark ceases to have effect as a result of a decision of a European Union trade mark court, the date on which that decision became final must be indicated, and a copy of that decision, which may be in the language in which the decision was given, must be submitted;
  - where conversion is requested because an IR designating the EU has been finally refused by the Office, the date of the decision must be indicated;
  - where conversion is requested because the effects of an IR designating the EU have been declared invalid by the Office or by an EUTM court, the date of the decision of the Office or the date on which the judgment of the EUTM court became final must be indicated, with a copy of the judgment attached;
  - where conversion is requested because the designation of the EU has been renounced or cancelled before WIPO, the date on which it was recorded by WIPO must be indicated;
  - where conversion is requested because the IR designating the EU has not been renewed, and provided that the grace period for renewal is over, the date on which the protection expired must be indicated.
- The indication of the Member State or the Member States for which conversion is requested; for an IR, it must also be indicated whether conversion is requested into a national application for that Member State or into a designation of the Member State under the Madrid Protocol. With regard to Belgium, the Netherlands and Luxembourg, conversion may be requested only for these three countries together, not separately. The conversion form made available by the Office only allows for Belgium, the Netherlands and Luxembourg to be designated together. If the applicant indicates only one of these three countries, the Office will consider it to be a request for conversion for Belgium, the Netherlands and Luxembourg and will forward the request to the Benelux Office for Intellectual Property (BOIP);
  - Where the request does not relate to all of the goods or services for which the application has been filed or for which the EUTM has been registered, an indication that it relates only to a part of the goods and services for which the application was filed or registered together with an indication of the goods and services for which conversion is requested;
  - An indication that conversion is requested for different goods and services with respect to different Member States, together with an indication of the respective goods and services for each Member State.

The request for conversion may also contain the appointment of a representative before a designated national office, if the relevant boxes in the Annex to the Conversion Form are ticked. This indication is voluntary and is not relevant for the conversion procedure before the Office. However, it will be useful for the national offices when they receive the request for conversion, as they will be able to



communicate immediately with a representative who is authorised to practise before them (see [paragraph 6](#) below).

### 5.3 Language

[Article 146\(6\)](#) and [Article 206 EUTMR](#)

Where the request for conversion is made in respect of an EUTM application, it must be filed in the language in which the EUTM application was filed or in the second language indicated therein.

Where the request for conversion is made in respect of an IR designating the EU before a statement of grant of protection has been issued pursuant to [Article 79 EUTMDR](#), the request must be filed in the language in which the international application was filed with WIPO or in the second language indicated therein.

[Article 146\(6\)](#) and [Article 206 EUTMR](#)

Where the request is made in respect of an EUTM registration, it may be filed in any of the five languages of the Office.

Where the request for conversion is made in respect of an IR designating the EU after a statement of grant of protection has been issued, the request may be filed in any of the five languages of the Office, except in the case of an ‘opting-back’ conversion, when the request must be filed in English, French or Spanish.

However, when the request for conversion is filed using the form provided by the Office pursuant to [Article 65 EUTMDR](#), the form may be used in any of the official languages of the Union, provided that textual elements are completed in one of the languages of the Office. This concerns, in particular, the list of goods and services in a request for partial conversion. In the event of a partial ‘opting-back’ conversion, the list of goods and services must be filed in English, French or Spanish.

### 5.4 Fees

Articles [140\(1\) and \(3\)](#), [180\(3\)](#) and [Annex I A\(23\) EUTMR](#)

The request for conversion, including for conversion of an IR designating the EU, is subject to payment of a fee of EUR 200. The request will not be considered to be filed until the conversion fee has been paid. This means that the conversion fee must be paid within the abovementioned time limit of three months. A payment made after expiry of that period will be considered to have been made in due time if the person concerned submits evidence that the payment was made to a bank or a transfer order placed, in a Member State and within the period of three months and if, at the time of

payment, a surcharge of 10 % of the total amount due was paid (see [the Guidelines, Part A, General Rules, Section 3, Payment of Fees, Costs and Charges](#)).

## 6 Examination by the Office

### 6.1 Stages of the procedure – competence

[Article 140 EUTMR](#)

[Article 111\(3\)\(p\) EUTMR](#)

[Article 23 EUTMIR](#)

The Office will deal with requests for conversion by:

- registering and publishing the receipt of a request for conversion;
- examining the request; and
- either transmitting the request to the designated offices or rejecting it.

### 6.2 Publication of the request and entry in the Register

[Article 111\(3\)\(p\)](#) and [Article 140\(2\) EUTMR](#)

Irrespective of its acceptance, a request for conversion that is considered to have been filed because the required fee has been paid (and provided that the request for conversion is of a published EUTM application or a registered EUTM), the Office will make an entry in the Register of European Union trade marks recording the receipt of the request for conversion. This request for conversion is also published in the EUTM Bulletin if the EUTM application has already been published in accordance with [Article 44 EUTMR](#).

The entry and the publication exclusively reflect that a request has been filed.

The entry in the Register and the publication of the receipt of the request for conversion contain the indications referred to in [Article 23 EUTMIR](#) and, unless it concerns an IR designating the EU, must refer to the previous publication in the EUTM Bulletin and the date of the application for conversion.

Articles [40\(1\)](#) and [202\(5\), \(6\), \(7\) and \(8\) EUTMR](#)

[Article 23 EUTMIR](#)

The lists of goods and services for which conversion is requested will not be published if the conversion is for an IR designating the EU.

## 6.3 Examination

The examination of the request for conversion by the Office relates to the following points:

- fees
- time limit
- language
- formalities
- grounds
- representation
- partial conversion.

### 6.3.1 Fees

Articles [140\(3\)](#) and [202\(6\)](#) EUTMR

The Office will examine whether the conversion fee has been paid within the applicable time limit.

Where the conversion fee has not been paid within the applicable time limit, the Office will inform the applicant that the request for conversion is considered not to have been filed. Any fees paid late will be reimbursed.

### 6.3.2 Time limit

Articles [140\(3\)](#) and [202\(6\)](#) EUTMR

When the request for conversion is considered to have been filed because the conversion fee has been paid within the applicable time limit (see [paragraph 6.3.1](#) above), the Office will examine if the request has been filed within the time limit of three months.

Where the request for conversion was not filed within the relevant time limit but payment was received on time, the Office will reject the request as inadmissible. Any fees paid will not be reimbursed.

### 6.3.3 Language

[Article 146\(6\)](#) and [Article 206 EUTMR](#)

The Office will examine whether the request has been filed in the correct language.

When the request is filed in a language that is not one of the acceptable languages for the conversion procedure (see [paragraph 5.3](#) above), the Office will send a deficiency letter to the applicant and specify a period within which it may amend the request for

conversion. If the applicant fails to respond, the request will not be dealt with and will be considered not to have been filed. Any fees paid will not be reimbursed.

#### 6.3.4 Formalities

##### [Article 22\(b\), \(d\) and \(e\) EUTMIR](#)

The Office will examine whether the request complies with the formal requirements of the EUTM Regulations (see [paragraph 5](#) above).

Where the applicant for conversion has not used the Conversion Form made available by the Office, and where the deficiency lies in the applicant not having indicated the elements referred to in [Article 22\(b\), \(d\) or \(e\) EUTMIR](#), either the applicant will be invited to submit the missing information or, where the information may be readily ascertained from data available to the Office, the Office will be considered as having been authorised to make available the relevant extracts from its database to the designated offices.

#### 6.3.5 Grounds

##### Articles [139\(2\)](#) and [202\(8\)](#) EUTMR

The Office will examine:

- whether one of the grounds for conversion referred to in [paragraph 2](#) exists;
- whether one of the grounds precluding conversion referred to in [paragraph 4](#) exists;
- for an opting-back conversion, whether it would have been possible at the date of the IR to designate the Member State concerned in an international application;
- for partial conversion, whether the goods and services to be converted were in fact contained in, and do not go beyond, the goods and services of the EUTM or IR designating the EU when it lapsed or ceased to have effect (see [paragraph 6.2](#));
- for partial conversion in the sense that part of the EUTM or IR designating the EU remains valid, if the goods and services to be converted overlap with the goods and services for which the mark remains valid (see [paragraph 6.2](#)).

The aim of these last two examination steps is to avoid conversion for more or broader goods and services than have been refused or cancelled.

When the request for conversion does not comply with any of the other mandatory elements and indications referred to in [paragraphs 4](#) and [5.2](#), the Office will send a deficiency letter to the applicant and specify a period within which it may amend the request for conversion. If the applicant fails to respond, the request will not be dealt with and will be considered not to have been filed. Any fees paid will not be reimbursed.

### 6.3.6 Representation

Articles [119\(3\)](#) and [120\(1\)](#) EUTMR

[Article 74\(1\) to \(3\) EUTMDR](#)

The general rules on representation apply (see [the Guidelines, Part A, General Rules, Section 5, Parties to the Proceedings and Professional Representation](#)). The applicant for conversion may appoint a new or an additional representative (legal practitioner or Office professional representative) for the conversion procedure.

Any authorisation to act on behalf of the applicant or proprietor extends only to acts before the Office. Whether a representative appointed for proceedings before the Office may act before the national office in respect of the resulting national application and, if so, whether they need to submit an additional authorisation, is determined by the national law concerned.

### 6.3.7 Partial conversion

[Article 139\(1\) EUTMR](#)

[Article 22\(e\) EUTMIR](#)

Where conversion is requested only for some of the goods and services, or for different goods and services for different Member States ('partial conversion'), the Office will examine whether the goods and services for which conversion is requested are contained within the goods and services for which the ground for conversion applies. The same criteria apply for this assessment as for similar procedural situations, such as the restriction of an application or partial refusal in opposition proceedings.

Where an application is refused in part or a registration is declared invalid or revoked in part, conversion may be requested only for the goods or services for which the application was refused or the registration was declared invalid or revoked, and not for the goods or services for which the application or registration remains valid.

Where an application is limited, or a registration is partially surrendered, conversion may be requested only for the limited or partially surrendered goods or services, and not for the goods or services for which the application or registration remains valid. However, please refer to [paragraph 4.3](#) above when such a limitation or partial surrender takes place following a decision.

The applicant must indicate in the abovementioned cases the goods and services for which conversion is requested. Expressing the limitation in a negative way, such as by using expressions of the type 'beverages with the exception of ...', is admissible in the same way that such an expression is admissible when filing or restricting an EUTM application or partially surrendering an EUTM registration (see [the Guidelines, Part B, Examination, Section 3, Classification](#)).

## 6.4 Transmission to designated offices

Articles [140\(3\) and \(5\)](#) and [141\(1\)](#) EUTMR

Once the Office has completed examination of the request for conversion and has found it to be in order, it will transmit the request without delay to the designated offices. The transmission will be made irrespective of whether any required publication has already taken place.

The Office will send a copy of the request for conversion to the designated offices and make available to them an extract of its database containing the data referred to in [Article 111\(2\) EUTMR](#) of the converted EUTM or IR. Any central industrial property office to which the request for conversion is transmitted may obtain from the Office any additional information concerning the request, which will enable that office to make a decision regarding the national trade mark resulting from the conversion.

[Article 140\(5\) EUTMR](#)

At the same time, the Office will inform the applicant for conversion of the date of transmission to the designated offices.

In the case of an opting-back conversion, WIPO will deal with the request as a subsequent designation in accordance with Rule 24(6), (7) CR.

If a national office is the designated office, conversion will result in a national application or registration.

[Article 141\(3\) EUTMR](#)

The national law in force for the Member States concerned may provide that the request for conversion be subject to one, or all, of the following requirements:

- payment of a national application fee;
- filing of a translation of the request and its accompanying documents in one of the official languages of the Member State in question. In particular, for applications for conversion prior to publication of the EUTM, the national office will usually require a translation of the list of goods and services;
- indication of an address for service in the Member State in question;
- submission of a representation of the mark in a number of copies specified by that Member State.

National rules on the appointment of a domestic representative remain applicable. Where use is made of the option in the Conversion Form to indicate a representative for the purposes of the procedure before a specific national office, that national office will be in a position to communicate directly with that representative so no separate communication to appoint a domestic representative will be necessary.

[Article 141\(2\) EUTMR](#)

National law may not subject the request for conversion to any formal requirements different from or additional to the requirements provided for in the EUTM Regulations.

## 7 Effects of Conversion

[Article 139\(3\) EUTMR](#)

In each Member State concerned, the national trade mark application resulting from the conversion will enjoy the filing date or the date of priority, if any, of the EUTM application, as well as the seniority of an earlier trade mark with effect for that Member State validly claimed for the EUTM application or registration under Article [39](#) or [40](#) EUTMR. For information on conversion of an EUTM into national trade mark applications for new Member States, see [the Guidelines, Part A, General Rules, Section 9, Enlargement](#).

In the event of an opting-back conversion, the international application resulting from the subsequent designation of the Member State under Rule 24(6)(e) and (7) CR will enjoy the original date of the IR designating the EU, that is, either the actual date of the IR (including, if appropriate, its priority date) or the date of the subsequent designation of the EU.

However, there is no harmonised procedure for how national offices will proceed with the examination of the converted EUTM. As mentioned in the introduction, the conversion procedure is a two-tier system, where the second tier, the conversion procedure itself, is dealt with by the national offices. Depending on national law, the converted trade mark will either be registered immediately or will enter the national examination, registration and opposition procedure like any other national trade mark application.

National applications deriving from the conversion of an earlier EUTM (application) are considered to come into existence as soon as a valid request for conversion is filed. Therefore, in opposition proceedings, such rights will be considered properly identified for admissibility purposes under [Article 2\(2\)\(b\)\(i\) EUTMDR](#) if the opponent indicates the number of the EUTM (application) under conversion and the countries for which it has requested conversion.

When, during opposition or invalidity proceedings on relative grounds, the EUTM application (or EUTM) on which the opposition is based ceases to exist or the list of goods and services is restricted, but at the same time a request for conversion is filed, the opposition or invalidity proceedings can continue. This is because national trade mark registrations resulting from a conversion of an EUTM application (or EUTM) can constitute the basis of the opposition or invalidity procedure originally made on the basis of that EUTM application or registration (15/07/2008, [R 1313/2006-G](#), *cardiva*

(fig.) / cardima (fig.)) (see also [the Guidelines, Part C, Opposition, Section 1, Opposition Proceedings, paragraph 4.2.2.2](#)).



**GUIDELINES FOR EXAMINATION**

**EUROPEAN UNION**  
**INTELLECTUAL PROPERTY OFFICE**  
**(EUIPO)**

***Part E***

***Register operations***

***Section 3***

***EUTMs and RCDs as objects of property***

## Table of Contents

<b>Chapter 1 Transfer.....</b>	<b>1532</b>
<b>Chapter 2 Licences, rights in rem, levies of execution, insolvency proceedings, entitlement proceedings or similar proceedings.....</b>	<b>1555</b>

**GUIDELINES FOR EXAMINATION**

**EUROPEAN UNION**  
**INTELLECTUAL PROPERTY OFFICE**  
**(EUIPO)**

***Part E***

***Register operations***

***Section 3***

***EUTMs and RCDs as objects of property***

***Chapter 1***

***Transfer***

## Table of Contents

<b>1 Introduction.....</b>	<b>1535</b>
1.1 Transfers.....	1536
1.1.1 Assignment.....	1536
1.1.2 Inheritance.....	1536
1.1.3 Merger.....	1536
1.1.4 Applicable law.....	1537
1.2 Legal effects of the transfer.....	1537
<b>2 Transfers v Changes of Name.....</b>	<b>1538</b>
2.1 Erroneous application to register a change of name.....	1539
2.2 Erroneous application for the registration of a transfer.....	1539
<b>3 Transfers v Changes of Ownership Due to Entitlement Proceedings for RCDs.....</b>	<b>1540</b>
<b>4 Requirements for an application for registration of a transfer.....</b>	<b>1540</b>
4.1 Languages.....	1540
4.2 Application for registration of a transfer filed for more than one mark.....	1542
4.3 Parties to the proceedings.....	1542
4.4 Formal requirements.....	1543
4.4.1 Indications concerning the EUTM and the new proprietor.....	1543
4.4.2 Representation.....	1543
4.4.3 Signatures.....	1544
4.4.4 Proceedings affecting the transfer.....	1544
4.5 Proof of transfer.....	1545
4.5.1 Translation of proof.....	1547
4.6 Procedure to remedy deficiencies.....	1547
4.7 Collective and Certification marks.....	1547
<b>5 Partial Transfers.....</b>	<b>1548</b>
5.1 Rules on the distribution of the lists of goods and services.....	1549
5.2 Objections.....	1550
5.3 Creation of a new EUTM.....	1550
<b>6 Transfer During the Course of Other Proceedings and Fees Issues.....</b>	<b>1550</b>
6.1 Specific issues of partial transfers.....	1551
6.2 Transfer and <i>inter partes</i> proceedings.....	1552
<b>7 Entry in the Register, Notification and Publication.....</b>	<b>1553</b>
7.1 Publication and Entry in the Register.....	1553
7.2 Notification.....	1553

<b>8 Transfers for Registered Community Designs.....</b>	<b>1553</b>
8.1 Rights of prior use for an RCD.....	1554
8.2 Fees.....	1554
<b>9 Transfers for international trade marks.....</b>	<b>1554</b>

## 1 Introduction

[Article 1\(2\)](#), Articles [19](#), [20](#), [27](#) and [28](#), [Article 111\(1\)](#) and [Article 111\(3\)\(g\)](#) EUTMR

Articles 27, 28 and 34 CDR

Article 23, Article 69(1) and Article 69(3)(i) CDIR

A transfer is the change in ownership of the property rights in a European Union trade mark (EUTM) or an EUTM application from one entity to another. EUTMs and EUTM applications may be transferred from the current proprietor to a new proprietor, primarily by way of assignment or legal succession. Unless otherwise provided, the practice applicable to EUTMs is also applicable to EUTM applications.

The transfer may be limited to some of the goods or services for which the mark is registered or applied for (partial transfer). In contrast to a licence or conversion, the transfer of an EUTM cannot affect the unitary character of the EUTM. Therefore, an EUTM cannot be 'partially' transferred for **some** territories or Member States.

Both registered Community designs (RCDs) and applications for an RCD may also be the subject of a transfer.

The provisions in the CDR and CDIR dealing with the transfer of registered Community designs are almost identical to the equivalent provisions of the EUTMR, EUTMDR and EUTMIR. **Therefore, the following applies *mutatis mutandis* to RCDs. Exceptions and specific provisions for RCDs are detailed in [paragraphs 3](#) and [7](#) below.**

On request of one of the parties, transfers of EUTMs are entered in the EUTM Register.

According to [Article 20 EUTMR](#), the registration of a transfer is not a condition for its validity. However, if a transfer is not registered by the Office, the successor may not invoke the rights arising from the EUTM. Moreover, the new proprietor will not receive communications from the Office, in particular, during *inter partes* proceedings, nor the notification of the renewal period of the mark. Furthermore, according to [Article 19 EUTMR](#), in all aspects of the EUTM as an object of property that are not further defined by provisions of the EUTMR, the proprietor's address defines the applicable subsidiary national law. Consequently, it is important to register a transfer at the Office to ensure that entitlement to EUTMs and EUTM applications is clear.

## 1.1 Transfers

[Article 20\(1\) and \(2\) EUTMR](#)

Article 28 CDR

A transfer of an EUTM involves two aspects, namely the validity of the transfer between the parties and the impact of a transfer on proceedings before the Office, which will only be triggered after the entry of the transfer in the EUTM Register (see [paragraph 1.2](#) below).

Regarding the validity of the transfer between the parties, the EUTMR allows an EUTM to be transferred independently of any transfer of the undertaking to which it belongs (30/03/2006, [C-259/04](#), Elizabeth Emanuel, EU:C:2006:215, § 45 and 48).

### 1.1.1 Assignment

[Article 20\(3\) EUTMR](#)

Article 28 CDR

When a transfer is made by an assignment, it is only valid where the assignment is made in writing and is signed by both parties, except where the assignment is the result of a court decision, or a decision taken by the Office under [Article 21 EUTMR](#). This formal requirement for the validity of the transfer of an EUTM is applicable irrespective of whether, under the national law governing transfers of (national) trade marks, an assignment is valid without observing a particular form, such as the need for the transfer to be in writing and have the signatures of both parties.

However, the change of ownership of RCDs due to entitlement proceedings before a national authority are not processed through a transfer but through a change in the ownership resulting from the final decision under Article 15 CDR.

### 1.1.2 Inheritance

When the proprietor of an EUTM dies, the heirs will become proprietors of the EUTM by way of individual or universal succession. This is also covered by the rules on transfers.

### 1.1.3 Merger

A universal succession also exists when there is a merger between two companies that leads to the formation of a new company, or an acquisition by one company taking over another. Where the whole of the undertaking to which the mark belongs is transferred, there is a presumption that the transfer includes the EUTM unless, in accordance with

the law governing the transfer, an agreement to the contrary was made or unless circumstances clearly dictate otherwise.

#### 1.1.4 Applicable law

[Article 19 EUTMR](#)

Article 27 CDR

Unless provided otherwise by the EUTMR, transfers are subject to the national law of a Member State determined by [Article 19 EUTMR](#). The national law applicable under that provision is the national law in general and, therefore, also includes private international law which, in turn, may refer to the law of another State.

## 1.2 Legal effects of the transfer

[Article 20\(11\) EUTMR](#)

[Article 27 EUTMR](#)

[Article 13 EUTMIR](#)

Article 28 CDR

Article 23 CDIR

As long as the transfer has not been entered in the EUTM or RCD Register, the successor in title may not invoke the rights arising from the registration of the EUTM or the RCD (see *mutatis mutandis* 16/01/2020, [T-128/19](#), Sativa, EU:T:2020:3, § 22, 25-26). The transfer has effects with regard to third parties only after entry in the Register. This does not apply to third parties who acquired rights in the EUTM before the transfer was registered, and knew about the transfer when they acquired those rights.

This also applies to a transfer based on the implementation of a decision, even if the judgment established proprietorship with previous or *ex tunc* effect (see [paragraph 7](#)).

However, in the period between the date when the Office receives the application to register a transfer and the date of registering the transfer, the new proprietor may already make submissions to the Office with a view to observing time limits. For example, if a party has applied to register the transfer of an EUTM application against which the Office has raised objections on absolute grounds, the new proprietor may reply to those objections (see [paragraph 6](#)).

In an application for registration of a transfer, the Office will only examine whether sufficient evidence of the transfer has been submitted.



For changes of ownership following national entitlement proceedings regarding RCDs, see [paragraph 3](#).

## 2 Transfers v Changes of Name

[Article 55 EUTMR](#)

Article 19 CDIR

A transfer must be distinguished from a change of name of the proprietor.

A change in the name of the proprietor is a change that does not affect the identity of the proprietor, whereas a transfer is a change in the identity of the proprietor.

In particular, no transfer is involved when a natural person changes their name due to marriage, or following an official procedure for changing a name, or when a pseudonym is used instead of the proper name, etc. In all these cases, the identity of the proprietor is not affected.

Where the name or the corporate status of a legal person changes, the criterion for distinguishing a transfer from a mere change of name is whether or not the identity of the legal person remains the same. If the identity remains the same, it will be registered as a change of name (06/09/2010, [R 1232/2010-4](#), Cartier, § 12-14). In other words, where there is no termination of the legal entity (such as would occur in the case of a merger by acquisition, where one company is completely absorbed by the other and ceases to exist) and no start-up of a new legal entity (e.g. as would be the case following the merger of two companies leading to the creation of a new legal entity), there is only a change in the formal corporate organisation that already existed, and not in the actual identity itself. Therefore, the change will be registered as a change of name, where appropriate.

For example, if an EUTM is in the name of Company A and, as the result of a **merger**, this company is absorbed by Company B, there is a **transfer** of assets from Company A to Company B.

Likewise, during a **division** of Company A into two separate entities, one being the original Company A and the other being a new Company B, if the EUTM in the name of Company A becomes the property of Company B, there is a **transfer** of assets.

Normally, there is no transfer if the company registration number in the national register of companies remains the same.

However, there is in principle the prima facie presumption that there is a transfer of assets if there is a change of country (see, however, 06/11/2013, [R 546/2012-1](#), PARFUMS LOVE / LOVE et al.).

If the Office has any doubt about the national law applicable to the legal person concerned, it may require appropriate information from the applicant for registration of the change of name.

Therefore, unless ruled to the contrary under the applicable national law, the change of company type, provided that it is not accompanied by a transfer of assets carried out by means of a merger or an acquisition, will be treated as a change of name and not as a transfer.

However, if the change of company type is the result of a merger, a division or a transfer of assets, depending on which company absorbs or is separated from the other, or on which company transfers which assets to the other, it may be a case of transfer.

## 2.1 Erroneous application to register a change of name

Articles [55\(1\), \(3\) and \(5\)](#) and [162\(1\)](#) EUTMR

Article 71 CDR

Article 19(1), (5) and (7) CDIR

When a request is made to register a change of name, but the evidence shows that it is actually a transfer of an EUTM, the Office informs the applicant accordingly and invites it to file an application for registration of a transfer within a specified period. If the applicant agrees or does not submit evidence to the contrary and files the corresponding application to register a transfer, the transfer will be registered. If the applicant does not modify its request and insists on registering the change as a change of name, or if it does not respond, the request to register a change of name will be rejected. The party concerned may file an appeal against this decision.

A new application for the registration of the transfer may be filed at any time.

## 2.2 Erroneous application for the registration of a transfer

[Article 20\(5\) and \(7\)](#) EUTMR

Article 23(1) and (5) CDIR

When an application is made to register a transfer, but what is involved is actually a change of name of an EUTM, the Office informs the applicant accordingly and invites it to give, within a specified period, its consent to register the indications concerning the proprietor in the EUTM Register. If the applicant agrees, the change of name will be registered. If the applicant does not agree and insists on registering the change as a transfer, or if it does not respond, the application for the registration of a transfer will be rejected.

### **3 Transfers v Changes of Ownership Due to Entitlement Proceedings for RCDs**

Articles 15 and 16 CDR

A transfer must be distinguished from a change of ownership following entitlement proceedings related to an RCD.

Pursuant to Article 15 CDR, RCDs may be the subject of entitlement proceedings and subsequent changes in ownership. Such changes in ownership are subject to a final decision from the competent authority and are entered in the RCD Register free of charge. For more information, see [Part E Register Operations, Section 3, Chapter 2 Licences, rights in rem, levies of execution, insolvency proceedings, entitlement proceedings or similar proceedings, paragraph 8.2.](#)

The main difference between a change of ownership and a transfer of an RCD is that a change of ownership is free of charge while a transfer is subject to a fee. In addition, the effects a change of ownership may have on already existing licences and other rights are different from the effects of transfers. Licences and other rights lapse when the person entitled is entered in the Register (Article 16(1) CDR).

The option of a claim to entitlement to an RCD does not exist for EUTMs. Judgments on the proprietorship of an EUTM must be implemented through a transfer, as seen in [paragraph 1.2.](#)

### **4 Requirements for an application for registration of a transfer**

It is strongly recommended that the application for registration of a transfer for an EUTM be submitted electronically via the Office's website (e-records). Using e-records has advantages, such as the automatic receipt of electronic confirmation of the application, and the possibility to use the manager feature to complete the form quickly for as many EUTMs as required.

#### **4.1 Languages**

[Article 146\(6\)\(a\) EUTMR](#)

Article 80(a) CDIR

The application for the registration of a transfer for an EUTM application must be made in the first or second language of the EUTM application.

[Article 146\(6\) EUTMR](#)

Article 80(c) CDIR

The application for the registration of a transfer for an EUTM must be submitted in one of the five languages of the Office, namely, English, French, German, Italian or Spanish.

However, when the application for the registration of a transfer is filed using the form provided by the Office pursuant to [Article 65\(1\)\(e\) EUTMDR](#) or Article 68 CDIR, according to [Article 146\(6\) EUTMR](#) and Article 80(c) CDIR, the form may be used in any of the official languages of the European Union, provided that it is completed in one of the languages of the Office, as far as textual elements are concerned.

When the application for the registration of the transfer relates to more than one EUTM application, the applicant must select a language for the application that is common to all the EUTMs concerned. If there is no common language, separate applications for registration of the transfer must be filed.

When the application for the registration of the transfer relates to more than one EUTM registration, the applicant must select one of the five languages of the Office as a common language.

[Article 24 EUTMIR](#)

Article 81(2) CDIR

Any supporting documents may be filed in any official language of the European Union. This applies to any document submitted as proof of the transfer, such as a countersigned transfer document or a transfer certificate, a deed of assignment or an extract from a trade register or a declaration agreeing to register the successor in title as the new proprietor.

When the supporting documents are submitted in an official language of the European Union that is not the language of the proceedings, the Office may require a translation into that language. The Office will set a time limit to submit the translation. If the translation is not submitted within the time limit, the document will not be taken into account and will be considered not to have been submitted.

## 4.2 Application for registration of a transfer filed for more than one mark

[Article 20\(8\) EUTMR](#)

Article 23(6) CDIR

A single application for the registration of a transfer for two or more EUTMs may be submitted only if the registered proprietor and beneficiary, or assignee, are the same in each case.

Separate applications are necessary when the original proprietor and the new one are not exactly identical for each mark. For example, this is the case where there is one successor in title for the first mark and there are multiple successors in title for another mark, even if the successor in title for the first mark is among the successors in title for the other mark. It is immaterial whether the representative is the same in each case.

When a single application is filed in such cases, the Office will issue a deficiency letter. The applicant may overcome the objection either by limiting the application for the registration of the transfer to those EUTMs or EUTM applications for which there is only one and the same original proprietor and only one and the same new proprietor, or by declaring its agreement that the application should be dealt with in two or more separate proceedings. Otherwise, the application for registration of a transfer will be rejected in its entirety. The party concerned may file an appeal against this decision.

## 4.3 Parties to the proceedings

[Article 20\(4\) and Article 20\(6\)\(b\) EUTMR](#)

[Article 13\(3\) EUTMIR](#)

Article 28(a) CDR

Article 23(4) CDIR

The application for registration of a **transfer** may be requested at the Office by:

1. the EUTM proprietor(s), or
2. the EUTM proprietor(s) jointly with the assignee(s), or
3. the assignee(s), or
4. a court or authority.

The formal conditions with which the application must comply depend on who submits the application.

## 4.4 Formal requirements

### 4.4.1 Indications concerning the EUTM and the new proprietor

[Article 20\(5\) EUTMR](#)

[Article 2\(1\)\(b\) and \(e\)](#), and [Article 13\(1\) EUTMIR](#)

[Article 1\(1\)\(b\) and \(e\)](#), and [Article 23\(1\) and \(2\) CDIR](#)

The application for registration of a transfer must contain the following information.

1. The registration number of the EUTM concerned. If the application relates to several EUTMs, each of the registration numbers must be indicated.
2. The details of the new proprietor. In the case of a natural person, the name, address and nationality must be indicated. In the case of a legal entity, the application must indicate the official designation and the legal form of the entity, which may be abbreviated in a customary manner (for example, S.L., S.A., Ltd., PLC). The company's national identification number may also be specified, if available. Both natural persons and legal entities must indicate the State in which they are domiciled or have their seat or an establishment. **The Office strongly recommends US companies to indicate, where applicable, the State of Incorporation, in order for it to differentiate clearly between different owners in its database.** These details correspond to the indications required for an applicant for a new EUTM application. However, where the Office has already assigned an ID number to the new proprietor, it is sufficient to indicate that number together with the name of the new proprietor.  
The form made available by the Office also requests an indication of the original proprietor's name. This indication will facilitate both the Office's and the parties' handling of the file.
3. If the new proprietor designates a representative, the representative's name and ID number assigned by the Office. If the representative has not yet been assigned an ID number, the business address must be indicated.

For additional requirements in cases of partial transfer, see [paragraph 5](#) below.

### 4.4.2 Representation

The general rules on representation apply (see [the Guidelines, Part A, General Rules, Section 5, Parties to the Proceedings and Professional Representation](#)).

#### 4.4.3 Signatures

[Article 20\(5\)](#), [Article 20\(6\)\(b\)](#), and [Article 119\(4\) EUTMR](#)

[Article 13\(2\) EUTMIR](#)

Article 23(1) and (4) CDIR

The requirements concerning the person entitled to file the application for registration of the transfer and the signatures must be considered together with the requirement to submit proof of the transfer. The principle is that the signatures of the original proprietor and the new proprietor must appear together or separately on the application for registration of the transfer or in an accompanying document. In the case of co-ownership, and where the transfer concerns the ownership as a whole, all co-owners must sign or appoint a common representative.

When the original proprietor and the new proprietor both sign the application for registration of the transfer, this is sufficient and no additional proof of the transfer is necessary.

When the original proprietor is the applicant for registration of the transfer and where the application is accompanied by a declaration signed by the successor in title stating that it agrees to the registration of the transfer, this is sufficient and no additional proof is necessary.

When the new proprietor is the applicant for registration of the transfer and where the application is accompanied by a declaration, signed by the original proprietor, stating that it agrees to the registration of the successor in title as the new proprietor, this is also sufficient and no additional proof is necessary.

When the original proprietor's representative is also appointed as the new proprietor's representative, the representative may sign the application for registration of the transfer on behalf of both the original and the new proprietor, and no additional proof is necessary. However, when the representative signing on behalf of both the original and the new proprietor is not the representative on file (i.e. in an application simultaneously appointing the representative and transferring the EUTM), the Office will contact the applicant for registration of the transfer to request evidence of the transfer (authorisation signed by the original proprietor, proof of transfer, confirmation of the transfer by the original proprietor or its representative on file).

#### 4.4.4 Proceedings affecting the transfer

The examination of the formal requirements for registering a transfer means taking into account facts that may have implications for the legality of that registration including the existence of insolvency proceedings at the national level (22/09/2021, [T-169/20](#), Marina Yachting, EU:T:2021:609, § 68).

Where a judgment declaring the registered proprietor of a mark as insolvent has been entered in the Register, any subsequent application for registration of a transfer

concerning the same mark will be automatically suspended and can only be acted upon with the express authorisation of the liquidator or the national court responsible for the insolvency proceedings. Where the Office registers a transfer but is made aware that the proprietor was insolvent at the relevant time, it may revoke the transfer.

Where the Office receives proof that ownership of a mark is being contested in a competent national court it will suspend any pending transfers until one of the parties has submitted a copy of the final decision of the dispute to the Office.

## 4.5 Proof of transfer

[Article 20\(2\) and \(3\) EUTMR](#)

[Article 65\(1\)\(e\) EUTMDR](#)

[Article 13\(1\)\(d\) and Article 13\(2\) EUTMIR](#)

Article 28 CDR

Article 23(1)(d) and (4)(a) to (c) and Article 68(1)(c) CDIR

A transfer may be registered only when it is proven by documents duly establishing the transfer, such as a copy of the deed of transfer. However, as already highlighted above, a copy of the deed of transfer is not necessary when:

- the new proprietor or its representative submits the application for registration of the transfer on its own together with a written declaration signed by the original proprietor (or its representative) stating that it agrees to the registration of the transfer to the successor in title; or
- the original proprietor or its representative submits the application for registration of the transfer on its own together with a written declaration signed by the new proprietor (or its representative) stating that it agrees to the registration of the transfer; or
- the application for registration of the transfer is signed by both the original proprietor (or its representative) and by the new proprietor (or its representative); or
- when the application for registration of the transfer is accompanied by a completed transfer form or document signed by both the original proprietor (or its representative) and by the new proprietor (or its representative).

Where proof of transfer is required, parties to the proceedings may also use the forms established under the Trademark Law Treaty available on WIPO's website (<https://wipolex.wipo.int/en/treaties/textdetails/12680>). The relevant forms are the 'Transfer Document' – a document conceived as constituting the transfer (assignment) itself – and the 'Certificate of Transfer' – a document in which the parties to a transfer declare that a transfer has taken place. Either of these documents, duly completed, constitutes sufficient proof of transfer.



However, other means of proof are not excluded. Therefore, the agreement (deed) itself or any other document proving the transfer may be submitted.

Regarding confidentiality, the party submitting the proof must bear in mind that the content of files are available for public inspection, and this is particularly relevant where contracts or other documents are submitted as evidence for a transfer, as they may contain sensitive data. Consequently, certain information may be **blacked out** before being submitted to the Office, or certain pages may **be omitted altogether**. The evidence required in support of a transfer does not need to include commercially sensitive items such as the price paid for the EUTM in question.

While omitting the sensitive information is preferable, alternatively, the Regulations do provide for confidentiality to be invoked where the party concerned expresses a special interest in keeping part of the file confidential. For more information on the formal requirements for invoking confidentiality, see the Guidelines, [Part E, Register Operations, Section 5, paragraph 5.1.3 'Parts of the file for which the party concerned expressed a special interest in keeping confidential'](#).

When the mark has been subject to multiple successive transfers and/or changes of the proprietor's name that have not been previously registered in the register, it is sufficient to submit the chain of evidence showing the events leading to the relationship between the original proprietor and the new proprietor without the need to file separate individual applications for each change.

When the transfer of the mark is the consequence of the transfer of the whole of the undertaking of the original proprietor, documents showing the transfer or assignment of the whole undertaking must be submitted.

When the transfer is due to a merger or another universal succession, the original proprietor will not be available to sign the application for registration of transfer. In this case, the application must be accompanied by supporting documents that prove the merger or universal succession, such as extracts from the trade register.

When the transfer of the mark is a consequence of a right *in rem*, a levy of execution or insolvency proceedings, the original proprietor will not be able to sign the application for registration of transfer. In these cases, the application must be accompanied by a final decision issued by a competent national authority transferring the ownership of the mark to the beneficiary.

It is not necessary to legalise supporting documents nor to submit the original of a document. Original documents become part of the file and, therefore, cannot be returned to the person who submitted them. Simple photocopies are sufficient.

If the Office has reason to doubt the accuracy or veracity of the document, it may require additional proof.

The Office will examine the documents only to the extent that they actually confirm what is indicated in the application, namely the identity of the marks concerned and the identity of the parties, and whether a transfer is involved. The Office does not consider or rule on contractual or legal questions arising under national law (09/09/2011,

[T-83/09](#), Craic, EU:T:2011:450, § 27). If doubts arise, the national courts deal with the legality of the transfer itself.

#### 4.5.1 Translation of proof

[Article 146\(1\) EUTMR](#)

[Article 24 EUTMIR](#)

Article 80(a) and (c) and Article 81(2) CDIR

The evidence must be:

1. in the language of the Office that has become the language of the proceedings for the registration of the transfer; or
2. in any official language of the European Union other than the language of the proceedings. In this case, the Office may require a translation of the document into a language of the Office to be submitted within a period specified by the Office.

Where the supporting documents are submitted in an official language of the European Union that is not the language of the proceedings, the Office may require a translation into that language. The Office will set a time limit to submit the translation. If the translation is not submitted within the time limit, the document will not be taken into account and will be considered not to have been submitted.

#### 4.6 Procedure to remedy deficiencies

[Article 20\(7\) and \(12\) EUTMR](#)

Article 28 CDR

Article 23(5) CDIR

The Office will inform the applicant for registration of the transfer in writing of any deficiencies in the application. If the deficiencies are not remedied within the time limit established in that communication, the Office will reject the application for registration of the transfer. .

#### 4.7 Collective and Certification marks

[Article 20\(5\) and \(7\)](#), and Articles [75](#), [79](#), [83](#), [84](#) and [88](#) EUTMR

The Office's practice in dealing with requests for transfer of EU collective marks and EU certification marks follows the principle that any new proprietor of an EU collective

mark or EU certification mark should comply with the same initial requirements the original proprietor was obliged to comply with at the time of filing of the EUTM.

It is understood therefore, that where a request for transfer is submitted in relation to an EU collective mark or an EU certification mark, in addition to the requirements and the documents duly establishing the transfer ([Article 20\(5\) EUTMR](#)), the Office will require the assignee to submit amended regulations of use (Articles [75](#), [79](#), [84](#) and [88](#) EUTMR). Specifically for EU certification marks, the applicant has to include in the regulations of use a declaration clearly specifying that the conditions of [Article 83\(2\) EUTMR](#) are fulfilled.

If these documents are not attached to the application for registration of the transfer, or if they do not comply with the requirements of Articles [75](#), [79](#), [84](#) and [88](#) EUTMR, a deficiency will be raised pursuant to [Article 20\(7\) EUTMR](#), and in the event the deficiency is not remedied, the application for the registration of the transfer will be refused.

For more information on the formal requirements of EU collective marks and EU certification marks, and on the content and requirements of the regulations of use, see [the Guidelines, Part B, Examination, Section 2, Formalities, paragraphs 8.2 and 8.3](#).

## 5 Partial Transfers

[Article 20\(1\) EUTMR](#)

[Article 14 EUTMR](#)

A partial transfer concerns only some of the goods and services in the EUTM and is only applicable to EUTMs (not to RCDs).

It involves the distribution of the original list of goods and services between the remaining EUTM and a new one. When partial transfers are involved, the Office uses particular terminology to identify the marks. At the beginning of the proceedings there is the 'original' mark. This is the mark for which a partial transfer has been applied. After the registration of the transfer, there are two marks: one is a mark that now has fewer goods and services, and is called the 'remaining' mark, and one is a 'new' mark that has some of the goods and services from the original mark. The 'remaining' mark retains the EUTM number of the 'original' mark while the 'new' mark has a new EUTM number.

Transfer cannot affect the unitary character of the EUTM. Therefore, an EUTM cannot be 'partially' transferred for **some** territories.

When there are doubts as to whether the transfer is partial or not, the Office will inform the applicant for registration of the transfer and invite it to make the necessary clarifications.

Partial transfers may also be involved when the application for registration of the transfer concerns more than one EUTM. The following rules apply for each EUTM included in the application.

## 5.1 Rules on the distribution of the lists of goods and services

Articles [33](#) and [49](#) EUTMR

[Article 14\(1\) EUTMR](#)

Communication No [1/2016](#) of the President of the Office of 08/02/2016

In the application for registration of a partial transfer, the goods and services to which the partial transfer relates must be indicated (the list of goods and services for the ‘new’ registration). The goods and services must be distributed between the original EUTM and the new EUTM so that the goods and services in the original EUTM and the new one do not overlap. The two specifications taken together must not be broader than the original specification.

Therefore, the indications must be clear, precise and unequivocal. For example, when an EUTM for goods or services in several classes is involved, and the ‘split’ between the original and new registration concerns entire classes, it is sufficient to indicate the respective classes for the new registration or for the remaining one.

When the application to register a partial transfer indicates goods and services that are explicitly mentioned in the original list of goods and services, the Office will automatically retain, in the original EUTM, the goods and services that are not mentioned in the application to register the partial transfer. For example, the original list contains goods A, B and C, and the transfer application relates to C; the Office will keep goods A and B in the original registration and create a new registration for C.

For further details concerning the scope of the list of goods and services, and for the Office’s practice regarding the interpretation of general indications of the Nice Classification class headings, please see [the Guidelines, Part B, Examination, Section 3, Classification](#), and [Communication No 1/2016](#) of the President of the Office of 08/02/2016 concerning the implementation of [Article 28 EUTMR](#) (now [Article 33 EUTMR](#)), and the [Annex](#) thereto.

In all cases, it is highly recommended to file a clear and precise list of goods and services to be transferred together with a clear and precise list of goods and services to remain in the original registration. Furthermore, the original list must be clarified. For example, if the original list related to *alcoholic beverages* and the transfer relates to *whisky* and *gin*, the original list must be amended by restricting it to *alcoholic beverages, except whisky and gin*.

## 5.2 Objections

[Article 20\(7\) EUTMR](#)

When the application for registration of a partial transfer does not comply with the rules explained above, the Office will invite the applicant to remedy the deficiency. If the deficiencies are not remedied, the Office will reject the application for registration of a partial transfer. The party concerned may file an appeal against the decision.

## 5.3 Creation of a new EUTM

[Article 20\(6\)\(c\) EUTMR](#)

[Article 14\(2\) EUTMIR](#)

A partial transfer leads to the creation of a new EUTM. For this new EUTM, the Office will establish a separate file, which will consist of a complete copy of the electronic file of the original EUTM, the application for registration of a transfer, and all the correspondence related to the application for registration of the partial transfer. The new EUTM will be given a new file number. It will have the same filing date and, where applicable, date of priority as the original EUTM.

As far as the original EUTM is concerned, the Office will include a copy of the application for registration of a transfer in its files, but will not normally include copies of the further correspondence relating to the transfer application.

## 6 Transfer During the Course of Other Proceedings and Fees Issues

[Article 20\(11\) and \(12\) EUTMR](#)

Article 28(b) and (c) CDR

Without prejudice to the right to act from the time when the application for registration of a transfer is received by the Office where time limits are involved, the new proprietor will automatically become party to any proceedings involving the mark in question from the time the transfer is registered.

The filing of an application for registration of a transfer has no effect on time limits already running or established by the Office, including time limits for the payment of fees. New time limits for payment will not be established. From the date of registration of the transfer, the new proprietor becomes liable to pay any fees due.

Therefore, it is important that, during the period between the filing of the application for registration of a transfer and the Office's confirmation of its actual entry in the EUTM Register or in the file, the original proprietor and the new proprietor actively collaborate in the communication of time limits and correspondence received during *inter partes* proceedings.

## 6.1 Specific issues of partial transfers

### [Article 20\(10\) EUTMR](#)

In cases of partial transfers, the new EUTM will be at the same procedural stage as the original (remaining) EUTM. Any time limit still pending for the original EUTM will be considered to be pending for both the remaining and the new EUTM. After registration of the transfer, the Office will treat each EUTM separately and will decide on them separately.

When an EUTM is subject to the payment of fees and these fees have been paid by the original proprietor, the new proprietor will not be liable to pay any additional fees for the new EUTM. The relevant date is the entry date of the transfer in the EUTM Register. Therefore, when the fee for the original EUTM is paid after an application for registration of a transfer has been filed but before the registration of the transfer itself, no additional fees are due.

### Articles [31\(2\)](#) and [41\(5\)](#) EUTMR

### [Annex I A\(3\) and \(4\)](#), [Annex I A\(7\) and \(8\)](#) EUTMR

When the partial transfer involves an EUTM application and class fees have not yet been paid or have not been paid in full, the Office will proceed to register the transfer in the files of the remaining EUTM application and to create a new EUTM application as described above.

Where additional class fees have to be paid for an EUTM application, the examiner will deal with such cases after creating a new EUTM application, as described below.

When additional class fees were paid prior to registering the transfer but no additional class fees were due for the remaining EUTM application, no reimbursement will be made because the fees were paid correctly at the time of payment.

In all other cases, the examiner will treat the remaining EUTM application and the new one separately, but will not require an additional basic fee to be paid for the new EUTM application. Class fees for the remaining EUTM application and for the new one will be determined according to the situation after the registration of the transfer. For example, when the original EUTM application had seven classes and, after the transfer, the remaining EUTM application has only one class while the new EUTM application has six, no additional class fees will be due for the remaining EUTM application, but the corresponding additional class fees must be paid for the new EUTM application. When

some of the goods and services of a particular class are transferred and others are not, the fees for that class become payable for both the remaining EUTM application and the new one. When a time limit already set to pay additional class fees has not yet expired, it will be set aside by the Office to allow the determination to be made according to the situation after the registration of the transfer.

[Article 53\(1\), \(3\) to \(5\) and \(7\) to \(8\) EUTMR](#)

When the application for registration of a partial transfer relates to an EUTM registration that is due for renewal, that is, within 6 months prior to the expiry of the original registration and up to 6 months after that expiry, the Office will proceed to register the transfer and deal with the renewal and renewal fees as described below.

When no request for renewal has been submitted and no fees have been paid prior to the registration of the transfer, the general rules, including the rules relating to the payment of fees, are applicable to both the remaining EUTM registration and the new one (separate requests, separate payment of fees, as necessary).

When a request for renewal has been submitted prior to the registration of the transfer, that request is also valid for the new EUTM. However, while the original proprietor remains a party to the renewal proceedings for the remaining EUTM, the new proprietor automatically becomes party to the renewal proceedings for the new registration.

When a request for renewal has been filed but the relevant fees have not been paid prior to the registration of the transfer, the fees to be paid are determined according to the situation after the registration of the transfer. This means that both the proprietor of the remaining EUTM and the proprietor of the new EUTM must pay the basic renewal fee and any class fees.

When a request for renewal has been filed prior to the registration of the transfer and all the applicable renewal fees have been paid prior to this date, no additional renewal fees are due after the registration of the transfer. No reimbursement is made of any class fees already paid.

## 6.2 Transfer and *inter partes* proceedings

When an application for registration of a transfer is filed during *inter partes* proceedings, several different situations can arise. For earlier EUTMs on which the opposition/cancellation is based, the new proprietor can only become party to the proceedings (or file observations) once the application for registration of the transfer has reached the Office. The basic principle is that the new proprietor substitutes the original proprietor in the proceedings. The practice of the Office when dealing with transfers in oppositions is described in [the Guidelines, Part C, Opposition, Section 1, Opposition Proceedings, paragraph 7.5](#).

## 7 Entry in the Register, Notification and Publication

### 7.1 Publication and Entry in the Register

[Article 20\(4\) and \(9\)](#), [Article 44](#), and [Article 111\(3\)\(g\) EUTMR](#)

Article 28(a) and Article 49 CDR

Article 23(7) and Article 70(3)(i) CDIR

The Office will enter the transfer in the EUTM Register and publish it in the EUTM Bulletin. The entry will be published once the EUTM application has been published pursuant to [Article 44 EUTMR](#).

The entry in the EUTM Register will mention the following data:

- the date of registration of the transfer,
- the new proprietor's name and address,
- the name and address of the new proprietor's representative, if any.

For partial transfers, the entry will also contain the following data:

- the number of the original registration and the number of the new registration,
- the list of goods and services remaining in the original registration, and
- the list of goods and services of the new registration.

### 7.2 Notification

The Office will notify the applicant of the registration of the transfer.

When the application for registration of the transfer was filed by the assignee, the Office will also inform the EUTM proprietor of the registration of the transfer.

## 8 Transfers for Registered Community Designs

Article 1(3) and Articles 27, 28, 33 and 34 and Article 107(2)(f) CDR

Article 23 and Article 61(2) and Articles 68(1)(c) and 69(2)(i) CDIR

Annexes No 16 and No 17 CDFR

The legal provisions contained in the CDR, CDIR and CDFR in respect of transfers correspond to the respective provisions in the EUTMR, EUTMDR and EUTMIR.



Therefore, both the legal principles and the procedure in respect of the registration of trade mark transfers apply *mutatis mutandis* to RCDs, except for the following specific procedures.

## 8.1 Rights of prior use for an RCD

Article 22(4) CDR

The right of prior use for an RCD cannot be transferred except where the third person, who owned the right before the filing or priority date of the application for an RCD, is a business, along with that part of the business in the course of which the act was done or the preparations were made.

## 8.2 Fees

Annexes No 16 and No 17 CDFR

The fee of EUR 200 for the registration of a transfer applies per design and not per multiple application. This is also the case for the ceiling of EUR 1 000 if multiple applications for registration of transfers are submitted.

## 9 Transfers for international trade marks

The Madrid System allows for the recording of a ‘change of ownership’ of an international registration.

All requests to record a change in ownership must be submitted on form MM5:

- directly to the International Bureau by the recorded holder; or
- through the office of the contracting party of the recorded holder or through the office of a contracting party in respect of which the transfer is granted; or
- through the office of the contracting party of the new proprietor (transferee).

The request to record a transfer cannot be submitted directly to the International Bureau by the new proprietor. The Office’s own application form should **not** be used.

Detailed information on changes in ownership can be found in paragraph 597 and the following ones of the [Guide to the Madrid System](#). See also the Guidelines, [Part M, International Marks](#).

**GUIDELINES FOR EXAMINATION**

**EUROPEAN UNION**  
**INTELLECTUAL PROPERTY OFFICE**  
**(EUIPO)**

***Part E***

***Register operations***

***Section 3***

***EUTMs and RCDs as objects of property***

***Chapter 2***

***Licences, rights in rem, levies of execution,  
insolvency proceedings, entitlement  
proceedings or similar proceedings***

## Table of Contents

<b>1 Introduction.....</b>	<b>1559</b>
1.1 Definition of licence contracts.....	1559
1.2 Definition of rights <i>in rem</i> .....	1560
1.3 Definition of levies of execution.....	1560
1.4 Definition of insolvency proceedings or similar proceedings.....	1560
1.5 Applicable law.....	1561
1.6 Advantages of registration.....	1562
<b>2 Requirements for an Application for Registration of a Licence, Right <i>in Rem</i>, Levy of Execution, and Insolvency Proceedings.....</b>	<b>1563</b>
2.1 Application form.....	1564
2.2 Languages.....	1564
2.3 Fees.....	1565
2.4 Parties to the proceedings.....	1565
2.4.1 Applicants.....	1565
2.4.2 Mandatory indications concerning the EUTM and the licensee, pledgee, beneficiary or liquidator.....	1566
2.4.3 Signatures.....	1567
2.4.4 Representation.....	1567
2.4.5 Proof.....	1567
2.4.6 Translation of proof.....	1567
2.5 Examination of the application for registration.....	1568
2.5.1 Fees.....	1568
2.5.2 Examination of the mandatory formalities.....	1568
<b>3 Procedure for Cancellation or Modification of the Registration.....</b>	<b>1569</b>
3.1 Competence, languages, presentation of the request.....	1570
3.2 Applicant for a cancellation or modification request.....	1570
3.2.1 Licences.....	1570
3.2.2 Rights <i>in rem</i> .....	1571
3.2.3 Levies of execution.....	1572
3.2.4 Insolvency proceedings.....	1573
3.3 Contents of the request.....	1573
3.4 Fees.....	1573
3.4.1 Cancellation.....	1573
3.4.2 Modification.....	1574
3.5 Examination of requests for cancellation or modification.....	1574

3.5.1 Fees.....	1574
3.5.2 Examination by the Office.....	1574
3.6 Registration and publication.....	1575
<b>4 Licences - Special Provisions.....</b>	<b>1575</b>
4.1 Requirements concerning proof.....	1575
4.1.1 Application made by the EUTM proprietor alone.....	1575
4.1.2 Application made jointly by the EUTM proprietor and the licensee.....	1576
4.1.3 Application made by the licensee alone.....	1576
4.1.4 Proof of the licence.....	1576
4.2 Optional contents of the application.....	1577
4.3 Examination of specific formalities (licences).....	1578
4.4 Examination of optional elements (licences).....	1578
4.5 Registration procedure and publication (licences).....	1580
4.6 Transfer of a Licence.....	1580
4.6.1 Provision for the transfer of a licence.....	1580
4.6.2 Applicable rules.....	1581
<b>5 Rights in Rem - Special Provisions.....</b>	<b>1581</b>
5.1 Requirements concerning proof.....	1581
5.1.1 Application submitted by the EUTM proprietor alone.....	1581
5.1.2 Application submitted jointly by the EUTM proprietor and the pledgee.....	1582
5.1.3 Application submitted by the pledgee alone.....	1582
5.1.4 Proof of the right <i>in rem</i> .....	1582
5.2 Examination of specific formalities requirements (rights <i>in rem</i> ).....	1583
5.3 Registration procedure and publication (rights <i>in rem</i> ).....	1584
5.4 Transfer of a Right <i>in rem</i> .....	1584
5.4.1 Provision for the transfer of a right <i>in rem</i> .....	1584
5.4.2 Applicable rules.....	1584
<b>6 Levies of Execution - Special Provisions.....</b>	<b>1585</b>
6.1 Requirements concerning proof.....	1585
6.1.1 Application filed by the EUTM proprietor.....	1585
6.1.2 Application filed by the beneficiary.....	1585
6.1.3 Proof of the levy of execution.....	1585
6.2 Registration procedure and publication (levy of execution).....	1586
<b>7 Insolvency Proceedings - Special Provisions.....</b>	<b>1586</b>
7.1 Requirements concerning proof.....	1586
7.2 Registration procedure and publication (insolvency proceedings).....	1586
<b>8 Procedures for Registered Community Designs.....</b>	<b>1587</b>

8.1 Multiple applications for RCDs.....	1587
8.2 Entitlement proceedings for RCDs.....	1588
8.2.1 Requirements for an application for registration of entries relating to entitlement proceedings.....	1588
8.2.2 Requirements concerning proof.....	1589
<b>9 Procedures for international trade marks.....</b>	<b>1590</b>
9.1 Recording of licences.....	1590
9.2 Recording of rights <i>in rem</i> , levies of execution or insolvency proceedings.....	1590

## 1 Introduction

Articles [19 to 29](#) EUTMR

Articles 27 to 34 CDR

Articles 23 to 26 CDIR

[Regulation \(EU\) 2015/848](#) of the European Parliament and of the Council of 20 May 2015 on insolvency proceedings

Decision No [EX-21-4](#) of the Executive Director of the Office of 30 March 2021 on the Register of EU trade marks, the Register of Community designs, the database of proceedings before the Office, and on the case-law database.

Both registered European Union trade marks (EUTMs) and EUTM applications may be the subject of licensing contracts (licences), rights *in rem* or levies of execution, or be affected by insolvency or similar proceedings. Unless otherwise provided, the practice applicable to EUTMs is also applicable to EUTM applications.

Both registered Community designs (RCDs) and applications for an RCD may be the subject of licences, rights *in rem* or levies of execution, or be affected by insolvency or similar proceedings.

The provisions in the CDR and CDIR dealing with design licences, rights *in rem* concerning designs, levies of execution concerning designs, and insolvency and similar proceedings concerning designs are almost identical to the corresponding provisions of the EUTMR and EUTMIR respectively. **Therefore, the following applies *mutatis mutandis* to RCDs. Exceptions and specific provisions for RCDs are detailed in [paragraph 8](#) below.** Specific procedures for international trade marks are laid down in [paragraph 9](#) below.

This section of the Guidelines deals with the procedures for registering, cancelling or modifying licences, rights *in rem*, levies of execution and insolvency proceedings or similar proceedings.

### 1.1 Definition of licence contracts

A trade mark licence is a contract by virtue of which the proprietor of a trade mark (the licensor), whilst retaining ownership, authorises a third person (the licensee) to use the trade mark in the course of trade, under the terms and conditions set out in the contract.

A licence refers to a situation where the rights of the licensee to use the EUTM arise from a contractual relationship with the proprietor. The proprietor's consent to, or tolerance of, a third party using the trade mark does not amount to a licence.

## 1.2 Definition of rights *in rem*

A right *in rem* or ‘real right’ is a limited property right that is an absolute right. Rights *in rem* refer to a legal action directed towards property, rather than towards a particular person, allowing the owner of the right the opportunity to recover, possess or enjoy a specific object. These rights may apply to trade marks or designs. They may consist, inter alia, in use rights, usufruct or pledges. ‘*In rem*’ is different from ‘*in personam*’, which means directed toward a particular person.

The most common rights *in rem* for trade marks or designs are pledges or securities. They secure the repayment of a debt of the proprietor of the trade mark or design (i.e. the debtor) in such a way that, where the proprietor cannot repay the debt, the creditor (i.e. the owner of the pledge or security) may receive repayment of the debt by, for example, selling the trade mark or design.

There are two types of right *in rem* for which the applicant can request entry in the EUTM Register:

- rights *in rem* that serve the purpose of guaranteeing securities (pledge, charge, etc.);
- rights *in rem* that do not serve as a guarantee (usufruct).

## 1.3 Definition of levies of execution

A levy of execution is the act by which a court officer appropriates a debtor’s property following a judgment of possession obtained by a plaintiff from a court. In this way, a creditor can recover its claim from all the property of the debtor, including from its trade mark rights.

## 1.4 Definition of insolvency proceedings or similar proceedings

For the purposes of these Guidelines, ‘insolvency proceedings’ are understood to be the collective proceedings that entail the partial or total divestment of a debtor and the appointment of a liquidator. They may include winding up by, or under the supervision of, a court, creditors’ voluntary winding up (with confirmation by the court), administration, voluntary arrangements under insolvency legislation and bankruptcy. ‘Liquidator’ is understood as any person or body whose function is to administer or liquidate assets of which the debtor has been divested or to supervise the administration of their affairs, and may include liquidators, supervisors of a voluntary arrangement, administrators, official receivers, trustees and judicial factors. ‘Court’ is understood to be the judicial body or any other competent body of a Member State empowered to open insolvency proceedings or to take decisions in the course of such proceedings. ‘Judgment’, in relation to the opening of insolvency proceedings or the appointment of a liquidator, is understood to include the decision of any court

empowered to open such proceedings or to appoint a liquidator (for terminology in other territories, see [Regulation \(EU\) 2015/848](#) on insolvency proceedings).

## 1.5 Applicable law

[Article 19 EUTMR](#)

Article 27 CDR

The EUTMR does not establish unified and complete provisions applicable to **licences, rights in rem** or **levies of execution** for EUTMs or EUTM applications. Instead, [Article 19 EUTMR](#) refers to the law of a Member State regarding the acquisition, validity and effects of the EUTM as an object of property, and regarding the procedure for levies of execution. To this end, a licence, a right *in rem* or a levy of execution for an EUTM is, in its entirety and for the whole territory of the European Union, assimilated to a licence, to a right *in rem*, or to a levy of execution for a trade mark registered in the Member State in which the EUTM proprietor has its seat or domicile. If the proprietor does not have a seat or domicile in a Member State, the licence, right *in rem* or levy of execution for an EUTM will be dealt with as a licence, right *in rem* or levy of execution for a trade mark registered in the Member State in which the proprietor has an establishment. If the proprietor does not have an establishment in a Member State, the licence, right *in rem* or levy of execution for an EUTM will be dealt with as a licence, right *in rem* or levy of execution for a trade mark registered in Spain (Member State in which the Office has its seat).

This, however, applies only to the extent that Articles [20 to 28](#) EUTMR do not provide otherwise.

[Article 19 EUTMR](#) is limited to the effects of a licence or right *in rem* as an object of property and does not extend to contract law. [Article 19 EUTMR](#) does not govern the applicable law or the validity of a licensing contract or right *in rem* contract, which means that the freedom of the contracting parties to submit the licensing contract or the right *in rem* contract to a given national law is not affected by the EUTMR.

[Article 21\(1\) EUTMR](#)

Article 31(1) CDIR

[Article 3\(1\) of Regulation \(EU\) 2015/848](#) on insolvency proceedings

Furthermore, these Guidelines serve to explain the procedure before the Office for registering the opening, modification or closure of **insolvency proceedings** or **similar proceedings**. In accordance with [Article 19 EUTMR](#), all other provisions are covered by national law. Moreover, [Regulation \(EU\) 2015/848](#) on insolvency proceedings regulates the provisions on jurisdiction, recognition and applicable law in the area of insolvency proceedings.



The regulations specifically state that an EUTM may only be involved in insolvency proceedings opened in the Member State in the territory of which the debtor has its centre of main interests. The only exception is when the debtor is an insurance undertaking or credit institution, in which case the EUTM may only be involved in those proceedings opened in the Member State where that undertaking or institution has been authorised. The 'centre of main interests' should correspond to the place where the debtor conducts the administration of its interests on a regular basis and is, therefore, ascertainable by third parties (for further information on the 'centre of main interests' see [Article 3\(1\) of Regulation \(EU\) 2015/848](#) of the European Parliament and of the Council of 20 May 2015 on insolvency proceedings).

## 1.6 Advantages of registration

[Article 27](#) and [Article 57\(3\) EUTMR](#)

Article 33 and Article 51(4) CDR

Article 27(2) CDIR

Entry in the EUTM Register of a licence agreement, a right *in rem*, a levy of execution, or the opening, modification and closure of insolvency proceedings is not compulsory. However, such registration has particular advantages.

1. In view of the provision of [Article 27\(1\) and \(3\) EUTMR](#), vis-à-vis third parties who might have acquired, or have entered in the EUTM Register, rights in the trade mark that are incompatible with the **registered licence, right *in rem* or levy of execution**, the licensee, pledgee or beneficiary respectively may avail itself of the rights conferred by this licence, right *in rem* or levy of execution only:

- if it was entered in the EUTM Register;
- or
- if the third party acquired its rights after the date of any legal acts such as those referred to in Articles [20](#), [22](#), [23](#), [25](#) and [26](#) EUTMR (a transfer, a right *in rem*, a levy of execution, or a previous licence), knowing of the existence of the licence, right *in rem* or levy of execution.

In view of [Article 27\(4\) EUTMR](#), vis-à-vis third parties that might have acquired or have entered in the EUTM Register rights in the trade mark that are incompatible with the **registered insolvency**, the effects will be governed by the law of the Member State in which such proceedings are first brought within the meaning of national law or of conventions applicable in this field.

2. Where a **licence or a right *in rem*** for an EUTM is entered in the EUTM Register, the surrender or partial surrender of that mark by its proprietor will only be entered in the EUTM Register if the proprietor establishes that it has informed the licensee or pledgee respectively of its intention to surrender.

The holder of a licence or the pledgee of a right *in rem* that is registered has, therefore, the right to be informed in advance by the proprietor of the trade mark of its intention to surrender the trade mark.

On entry in the EUTM Register of **insolvency proceedings or a levy of execution** against an EUTM, the proprietor loses its right to act and, therefore, may not perform any actions before the Office (such as withdraw, surrender, transfer, act in *inter partes* proceedings).

3. Where a **licence, right in rem, levy of execution, or insolvency proceedings** for, or against, an EUTM is entered in the EUTM Register, the Office will notify the licensee, pledgee, beneficiary or liquidator, respectively, of the approaching expiry of the registration at least six months beforehand.
4. Registering **licences, rights in rem, levies of execution and insolvency proceedings** (and their modification and/or cancellation, where applicable) is important for maintaining the veracity of the EUTM Register, particularly in the event of *inter partes* proceedings.

However,

1. when a party to proceedings before the Office has to prove use of an EUTM, if such use has been made by a licensee, it is not necessary for the **licence** to have been entered in the EUTM Register for that use to be considered to be use with the proprietor's consent pursuant to [Article 18\(2\) EUTMR](#);
2. registration is not a condition for considering the use of a trade mark by a pledgee under the terms of the **right in rem** contract to have been made with the consent of the proprietor pursuant to [Article 18\(2\) EUTMR](#);
3. the Office strongly recommends that liquidators duly inform the Office of the withdrawal, surrender or transfer of EUTMs subject to **insolvency proceedings** prior to the final winding up.

## 2 Requirements for an Application for Registration of a Licence, Right *in Rem*, Levy of Execution, and Insolvency Proceedings

Articles [22\(2\)](#), [23\(3\)](#), [24\(3\)](#) and [25\(5\)](#), [Article 26](#) and [Article 111\(3\) EUTMR](#)

Articles 29(2), 30(3), 31(3) and 32(5) CDR

Articles 24 and 25 CDIR

The application for registration of a licence, a right *in rem*, a levy of execution, or insolvency proceedings must comply with the following conditions.

## 2.1 Application form

[Article 146\(6\) EUTMR](#)

[Article 65\(1\)\(f\) EUTMDR](#)

Article 68(1)(d) and Article 80 CDIR

It is strongly recommended that the application for registration of a licence, a right *in rem*, a levy of execution or insolvency proceedings for an EUTM be submitted electronically via the Office's website (e-recordals). Using e-recordals has advantages, such as the automatic receipt of electronic confirmation of the application and the possibility to use the manager feature to complete the form quickly for as many EUTMs as required.

Articles [20\(8\)](#) and [26\(1\)](#) EUTMR

Articles 23(6) and 24(1) CDIR

A single application for the registration of a **licence** for two or more EUTMs may be made only if the registered proprietor and the licensee are the same and the contracts have the same conditions, limitations and terms in each case (see [paragraph 2.5](#) below).

A single application for the registration of a **right *in rem* or a levy of execution** for two or more registered EUTMs may be submitted only if the registered proprietor and beneficiary are the same in each case.

## 2.2 Languages

[Article 146\(6\)\(a\) EUTMR](#)

Article 80(a) CDIR

The application for the registration of a licence, a right *in rem*, a levy of execution, or insolvency proceedings for an EUTM application must be made in the first or second language of the EUTM application.

[Article 146\(6\)\(b\) EUTMR](#)

Article 80(c) CDIR

The application for the registration of a licence, a right *in rem*, a levy of execution, or insolvency proceedings for an EUTM must be submitted in one of the five languages of the Office, namely, English, French, German, Italian or Spanish.

However, when the application for the registration of a licence, a right *in rem*, a levy of execution, or insolvency proceedings is filed using the form provided by the Office pursuant to [Article 65\(1\)\(f\) EUTMDR](#) and Article 68 CDIR, the form may be used in any of the official languages of the European Union, provided that it is completed in one of the languages of the Office, as far as textual elements are concerned.

## 2.3 Fees

[Article 26\(2\)](#) and [Annex I A\(26\) and \(27\) EUTMR](#)

Articles 23(3) and 24(1) CDIR

Annex (18) CDFR

The application for the registration of a **licence, a right *in rem* or a levy of execution** is considered not to have been made until the fee is paid. The amount of this fee is EUR 200 for each EUTM for which the registration is requested.

However, where several registrations of **licences, rights *in rem* or levies of execution** have been applied for in one single application and the registered proprietor and the licensee (and contractual terms), pledgee, or beneficiary are the same in all cases, the fee is limited to a maximum of EUR 1 000.

The same maximum amount applies where several registrations of **licences, rights *in rem* or levies of execution** are applied for at the same time, provided that they could have been filed in one single application and that the registered proprietor and the licensee, pledgee or beneficiary are the same in all cases. Furthermore, for the registration of **licences or rights *in rem***, the contractual terms must be the same. For example, an exclusive licence and a non-exclusive licence cannot be filed in the same application, even if they are between the same parties.

Once the corresponding fee has been paid, it will not be reimbursed if the application for registration is refused or withdrawn.

There is no fee for registering **insolvency proceedings** or similar proceedings.

## 2.4 Parties to the proceedings

### 2.4.1 Applicants

[Articles 22\(2\), 23\(3\), 25\(5\)](#) and [117\(1\) EUTMR](#)

Articles 29(2), 30(3) and 32(5) CDR

An application for the registration of a **licence**, of a **right *in rem*** or of a **levy of execution** at the Office may be filed by:

1. the EUTM proprietor(s); or
2. the EUTM proprietor(s) jointly with the licensee(s)/pledgee(s)/beneficiary(ies); or
3. the licensee(s)/pledgee(s)/beneficiary(ies).

Where the Office receives documents relating to such existing rights on EUTMs or RCDs from third parties or authorities such as national Registers or national Courts, it will forward the documents to the EUTM proprietor/RCD holder with a notice indicating that such a right could be entered in the EUTM or RCD Register upon request and payment of the relevant fees. Additionally, if the rights holder (pledgee or beneficiary) is fully identified by its contact details, the same notice will also be sent, for information only, to the pledgee(s)/beneficiary(ies). The document will be incorporated into the files relating to the EUTM or RCD affected.

[Article 24\(3\) EUTMR](#)

Article 31(3) CDR

The application for the registration of **insolvency proceedings** may be requested by:

1. a Court, or
2. competent national authorities, including the liquidator in the insolvency proceedings; or
3. any of the parties.

2.4.2 Mandatory indications concerning the EUTM and the licensee, pledgee, beneficiary or liquidator

Articles [24\(2\)](#) and [26\(1\)](#) EUTMR

[Article 2\(1\)\(b\) and \(e\) EUTMIR](#)

[Article 13 EUTMDR](#)

Article 31 CDR

Article 1(1)(b) and (e), Articles 23 and 24 CDIR

The application for registration of a licence, a right *in rem*, a levy of execution or insolvency proceedings must contain the following information.

1. The registration number of the EUTM concerned. If the application relates to several EUTMs, each of the registration numbers must be indicated.  
Additionally, for **insolvency proceedings**, the Office will register the **insolvency proceedings** against **all** EUTMs/RCDs linked to the proprietor's ID number at the Office.

Where the proprietor is the joint proprietor of an EUTM or RCD, the **insolvency proceedings** will apply to the share of the joint proprietor.

2. The licensee's, pledgee's, beneficiary's or liquidator's name, address and nationality (for RCDs only), as well as the State in which it is domiciled or has its seat or an

establishment. However, if the Office has already assigned an ID number to them, it is sufficient to indicate this number together with the name.

3. If the licensee, pledgee, beneficiary or liquidator designates a representative, the representative's name and ID number assigned by the Office. If the representative has not yet been assigned an ID number, the business address must be indicated.

#### 2.4.3 Signatures

[Article 63\(1\)\(a\) EUTMDR](#)

Article 67(4) CDIR

Where the requirement of a signature is referred to, in electronic communications, the indication of the sender's name is considered to be equivalent to the signature.

The general rules on signatures apply (see [the Guidelines, Part A, General Rules, Section 1, Means of Communication, Time Limits](#)).

#### 2.4.4 Representation

Articles [119\(2\)](#) and [120\(1\)](#) EUTMR

Articles 77(2) and 78(1) CDR

The general rules on representation apply (see [the Guidelines, Part A, General Rules, Section 5, Parties to the Proceedings and Professional Representation](#)).

#### 2.4.5 Proof

Articles [55](#) and [64](#) EUTMDR

For the special provisions and specific requirements with regard to proof, see the paragraphs below. These give details based on the type of right being registered: [paragraph 4.1](#) for licences; [paragraph 5.1](#) for rights *in rem*; [paragraph 6.1](#) for levies of execution; [paragraph 7.1](#) for insolvency proceedings.

#### 2.4.6 Translation of proof

[Article 146\(6\) EUTMR](#)

[Article 24 EUTMIR](#)

Article 80 and Article 81(2) CDIR

Proof must be as follows.

1. In the language of the Office that has become the language of the proceedings for the registration of the licence, right *in rem*, levy of execution or insolvency proceedings, see [paragraph 2.2](#) above.
2. Or in any official language of the European Union other than the language of the proceedings. In this case, the Office may require a translation of the document into a language of the Office to be submitted within a period specified by the Office. The Office will set a time limit for submission of the translation. If the translation is not submitted within that time limit, the document will not be taken into account and will be considered not to have been submitted.

## 2.5 Examination of the application for registration

### 2.5.1 Fees

[Article 26\(2\) EUTMR](#)

Articles 23(3) and 24(1) CDIR

Where the required fee has not been received, the Office will notify the applicant that the application is considered not to have been filed because the relevant fee has not been paid. However, a new application may be submitted at any time providing the correct fee is paid from the outset.

There is no fee for applications for the registration of **insolvency proceedings** or similar proceedings.

### 2.5.2 Examination of the mandatory formalities

[Article 24\(1\) EUTMR](#)

Article 31(1) CDR

For **insolvency proceedings**, the Office will check that there are no other pending records and that no insolvency proceedings have already been registered for the proprietor concerned.

[Article 26\(4\) EUTMR](#)

Article 24(3) CDIR

The Office will check whether the application for registration complies with the formal conditions mentioned in [paragraph 2.4](#) above and with the specific requirements given below, based on the type of right being registered (see [paragraph 4.1](#) for licences, [paragraph 5.1](#) for rights *in rem*, [paragraph 6.1](#) for levies of execution, and [paragraph 7.1](#) for insolvency proceedings).

[Article 26](#) and [Article 120\(1\)](#) EUTMR

Article 78(1) CDR

Article 24 CDIR

The Office will check whether the application for registration of the **licence, right in rem, levy of execution or insolvency proceedings** has been duly signed. Where the application is signed by the licensee's, pledgee's, beneficiary's or liquidator's representative, an authorisation may be required by the Office or, in the case of *inter partes* proceedings, by the other party to the proceedings. In this case, if no authorisation is submitted, the proceedings will continue as if no representative had been appointed.

Where the application for registration of the **licence, right in rem, insolvency proceedings** or **levy of execution** is signed by the representative that has already been designated as the proprietor's representative for the EUTM in question, the requirements relating to signatures and authorisations are fulfilled.

[Article 26\(4\)](#) EUTMR

Article 24(3) CDIR

The Office will inform the applicant in writing of any deficiencies in the application. If the deficiencies are not remedied within the period established in that communication, the Office will reject the application for registration of the right.

For additional specific formalities that concern only **licences** and **rights in rem**, see the special provisions below ([paragraphs 4.3](#) and [4.4](#) for licences, and [paragraph 5.2](#) for rights *in rem*).

### 3 Procedure for Cancellation or Modification of the Registration

Articles [29\(1\)](#) and [117\(1\)](#) EUTMR

Article 26(1) CDIR

The registration of a **licence**, a **right in rem**, a **levy of execution** or **insolvency proceedings** will be cancelled or modified at the request of an interested party, that is, the applicant or proprietor of the EUTM or the registered licensee, pledgee, beneficiary or liquidator. In **insolvency proceedings**, it may also be the relevant national authority or court.

A registration of a **licence** or **right in rem** may also be transferred (see [paragraph 4.6](#) for licences and [paragraph 5.4](#) for rights *in rem*). The application should make a clear distinction between a request for modification and a request for transfer.



The Office will refuse the cancellation, transfer and/or modification of a **licence**, **sublicence** or **right in rem** if the main licence or right *in rem* has not been entered in the EUTM Register.

### 3.1 Competence, languages, presentation of the request

[Article 29\(3\) and \(6\)](#), and [Article 162 EUTMR](#)

Article 104 CDR

Article 26(3), (6) and (7) CDIR

[Paragraphs 2.1](#) and [2.2](#) above apply.

It is strongly recommended that requests for cancellation or modification of a **licence**, **right in rem**, **levy of execution or insolvency proceedings** be submitted using the official forms available on the Office's website. Parties to the proceedings may also use WIPO Model International Form No 1, 'Request for Amendment/Cancellation of Recordal of License', (found in the annex to the Joint Recommendation concerning trademark licenses adopted by the Assembly of the Paris Union and the General Assembly of WIPO on 25/09/2000 to 03/10/2000), which can be downloaded at <http://www.wipo.int/edocs/pubdocs/en/marks/835/pub835.pdf>, or a form with a similar content and format.

### 3.2 Applicant for a cancellation or modification request

[Article 29\(1\) and \(6\)](#) and [Article 117\(1\) EUTMR](#)

Article 26(1), (4) and (6) CDIR

Requests for cancellation or modification of a registration may be submitted by the same parties who can file applications for registration (see [paragraph 2.4.1](#) above).

#### 3.2.1 Licences

##### 3.2.1.1 Cancellation of a licence

In the case of a joint request submitted by the EUTM proprietor and the licensee, or of a request submitted by the licensee, no proof of the cancellation of the licence is required, since the request itself implies a statement from the licensee that it consents to the cancellation of the registration of the licence. However, a request for cancellation submitted by the EUTM proprietor alone must be accompanied by proof that the registered licence no longer exists, or by a declaration from the licensee to the effect that it consents to the cancellation.

Where a registered licensee alone submits a request for cancellation, the EUTM proprietor will not be informed thereof.

If the EUTM proprietor alleges fraud on the part of the licensee, it must submit a final decision of the competent authority to this effect. It is not within the remit of the Office to carry out any investigation in that respect.

Where several licences were requested simultaneously, it is possible to cancel them individually.

The entry in the EUTM Register of licences that are limited in time, that is, temporary licences, does not automatically expire but must be cancelled from the EUTM Register.

### 3.2.1.2 Modification of a licence

In the case of a joint request from the EUTM proprietor and the licensee, no further proof of the modification of the licence is required.

If the request is made by the EUTM proprietor, proof of the modification of the licence is required only where the modification for which entry in the EUTM Register is requested is of such a nature that it would diminish the rights of the registered licensee under the licence. For example, this would be the case if the licensee's name were to change, if an exclusive licence were to become a non-exclusive licence, or if the licence were to become restricted regarding its territorial scope, the period of time for which it is granted, or the goods or services to which it applies.

If the request is made by the registered licensee, proof of the modification of the licence is required only where the modification for which entry in the EUTM Register is requested is of such a nature that it would extend the rights of the registered licensee under the licence. For example, this would be the case if a non-exclusive licence were to become an exclusive licence, or if any registered restrictions of the licence as to its territorial scope, the period of time for which it is granted, or the goods or services to which it applies, were to be cancelled fully or in part.

Where proof of the modification of the licence is necessary, it is sufficient if any of the documents referred to in [paragraph 4.1.4](#) below are submitted, subject to the following requirements.

- The written agreement must be signed by the other party to the licence contract and must relate to the registration of the modification of the licence as requested.
- The request for modification or cancellation of a licence must indicate how the licence has been modified.
- The copy or extract of the licence agreement must be of the licence as modified.

## 3.2.2 Rights *in rem*

### 3.2.2.1 Cancellation of the registration of a right *in rem*

If the EUTM proprietor and the pledgee submit a joint request, or if the pledgee alone submits a request, no proof of the cancellation of the registration of the right *in rem* is

required, since the request itself implies a statement by the pledgee that it consents to the cancellation of the registration of the right *in rem*. When the request for cancellation is submitted by the EUTM proprietor, it must be accompanied by proof that the registered right *in rem* no longer exists, or by a declaration by the pledgee that it consents to the cancellation.

Where the registered pledgee submits the request for cancellation by itself, the EUTM proprietor will not be informed thereof.

Where the registration of several rights *in rem* was requested simultaneously, it is possible to cancel them individually.

#### 3.2.2.2 Modification of the registration of a right *in rem*

If the EUTM proprietor and the pledgee submit a joint request, no further proof of the modification of the registration of the right *in rem* is required.

If the request is submitted by the EUTM proprietor or the registered pledgee, proof of the modification of the registration of the right *in rem* is required.

Where proof of the modification of the registration of the right *in rem* is necessary, it is sufficient if any of the documents referred to in [paragraph 5.1.4](#) below are submitted, subject to the following requirements.

- The written agreement must be signed by the other party to the right *in rem* agreement and must relate to the registration of the modification of the right *in rem* as requested.
- The request for modification or cancellation of the registration of a right *in rem* must show the right *in rem* in its modified form.
- The copy or extract of the right *in rem* agreement must show the right *in rem* in its modified form.

#### 3.2.3 Levies of execution

##### 3.2.3.1 Cancellation of the registration of a levy of execution

A request for cancellation of the registration of a levy of execution must be accompanied by proof that the registered levy of execution no longer exists. This proof comprises the final decision of the competent authority.

##### 3.2.3.2 Modification of the registration of a levy of execution

A levy of execution may be modified on submission of the corresponding final decision of the competent authority showing such modification.

### 3.2.4 Insolvency proceedings

#### 3.2.4.1 Cancellation of the registration of an insolvency

A request for the cancellation of the registration of insolvency proceedings must be accompanied by proof that the registered insolvency no longer exists. This proof comprises the final decision of the competent authority.

#### 3.2.4.2 Modification of the registration of an insolvency

The registration of insolvency proceedings may be modified on submission of the corresponding final decision of the competent authority showing such modification.

## 3.3 Contents of the request

[Article 29\(1\) EUTMR](#)

[Article 12 EUTMIR](#)

Articles 19 and 26 CDIR

[Paragraph 2.4](#) above applies, except that the data concerning the licensee, pledgee, beneficiary or liquidator need not be indicated except in the case of a modification of the registered licensee's, pledgee's, beneficiary's or liquidator's name.

[Paragraph 4.2](#) below applies if a modification of the scope of a **licence** is requested, for example, if a licence becomes a temporary licence or if the geographical scope of a licence is changed.

## 3.4 Fees

### 3.4.1 Cancellation

[Article 29\(3\)](#) and [Annex I A\(27\) EUTMR](#)

Article 26(3) CDIR

Annex (19) CDFR

Any request for the cancellation of **licences**, **rights *in rem*** and **levies of execution** is considered not to have been made until the fee is paid. The fee is EUR 200 for each EUTM for which cancellation is requested.

However, where several requests for cancellations of licences, rights *in rem* and levies of execution are applied for in one single application or at the same time, and the

registered proprietor and the licensee (including contractual terms), pledgee, or beneficiary are the same in all cases, the cancellation fee is limited to a maximum of EUR 1 000.

This applies irrespective of how the initial applications for registration of these licences, rights *in rem* or levies of execution were filed. This means that, even where the initial applications for registration of these rights were staggered over time and could not, therefore, benefit from the maximum fee of EUR 1 000, they can still benefit from the maximum fee of EUR 1 000 if their cancellation is requested in the same application for cancellation.

Requests for cancellation of the registration of **insolvency proceedings** are not subject to a fee.

### 3.4.2 Modification

[Article 29\(3\) EUTMR](#)

Article 26(6) CDIR

Modification of the registration of a licence, a right *in rem*, a levy of execution, or insolvency proceedings is not subject to a fee.

## 3.5 Examination of requests for cancellation or modification

### 3.5.1 Fees

[Article 29\(3\) EUTMR](#)

Article 26(3) CDIR

Where the required fee for a request for cancellation of a **licence**, a **right *in rem***, or a **levy of execution** has not been received, the Office will notify the applicant that the request for cancellation is considered not to have been filed.

As seen above, requests for cancellation of the registration of **insolvency proceedings** are not subject to a fee.

### 3.5.2 Examination by the Office

[Article 29\(2\) and \(4\) EUTMR](#)

Article 26(2) and (4) CDIR

For the mandatory elements of the request, [paragraph 2.5.2](#) above applies *mutatis mutandis*, including in respect of proof, to the extent that such proof is required.

Additionally, specific formalities apply to **licences** (see [paragraph 4.3](#) below), to **rights in rem** (see [paragraph 5.2](#) below), to **levies of execution** (see [paragraph 6.1](#) below) and to **insolvency proceedings** (see [paragraph 7.1](#) below).

The Office will notify the applicant for cancellation or modification of any deficiency, setting a time limit of 2 months. If the deficiencies are not remedied, the Office will reject the request for cancellation or modification.

[Article 29\(1\), \(2\), \(4\) and \(5\), Articles 111\(6\) and 117\(1\) EUTMR](#)

Articles 26(6) and 69(6) CDIR

[Paragraph 4.4](#) below applies to the extent that modification of the **licence** would affect its nature or its limitation to a part of the goods and services covered by the EUTM.

Registration of the cancellation or modification of a **licence**, a **right in rem**, a **levy of execution** or **insolvency proceedings** will be communicated to all the parties concerned.

### 3.6 Registration and publication

Articles [111\(3\)\(s\)](#) and [116\(1\)\(a\)](#) EUTMR

Article 69(3)(t) and Article 70(2) CDIR

The creation, cancellation or modification will be entered in the EUTM Register and published in the EUTM Bulletin.

## 4 Licences - Special Provisions

### 4.1 Requirements concerning proof

[Article 19](#) and [Article 26\(1\) EUTMR](#)

[Articles 2\(1\)\(b\)](#) and [13\(3\)\(a\) EUTMR](#)

Article 27 CDR

Article 1(1)(b) and Articles 23(4) and 24(1) CDIR

#### 4.1.1 Application made by the EUTM proprietor alone

When an application for the registration of a licence is made by the EUTM proprietor alone, it must be signed by the EUTM proprietor. In the case of co-ownership, all co-owners must sign or appoint a common representative.

No proof of the licence is necessary.

The Office will inform the licensee when the licence is registered in the EUTM Register.

The licensee may file a statement with the Office to oppose the registration of the licence. The Office will not take any further action on the statement but will register the licence. Following the registration of the licence, any licensee that disagrees with the registration of the licence may request the cancellation or modification of the licence (see [paragraph 3](#) above).

The Office will not take into account whether or not the parties, although having agreed to a licence contract, have agreed to register it at the Office. Any dispute regarding the licence is a matter that must be resolved among the parties concerned under the relevant national law ([Article 19 EUTMR](#)).

#### 4.1.2 Application made jointly by the EUTM proprietor and the licensee

When an application for the registration of a licence is made jointly by the EUTM proprietor and its licensee, it must be signed both by the EUTM proprietor and the licensee. In the case of co-ownership, all co-owners must sign or appoint a common representative.

In this case, the signature of both parties constitutes proof of the licence.

Where there is a formal deficiency regarding the signature of the licensee or regarding its representative, the application will still be accepted as long as it would have been acceptable if it had been presented by the EUTM proprietor alone.

The same applies where there is a deficiency regarding the signature of the EUTM proprietor or regarding its representative, but where the application would have been acceptable if it had been presented by the licensee alone.

#### 4.1.3 Application made by the licensee alone

An application for the registration of a licence may also be made by the licensee alone. In this case, it must be signed by the licensee and proof of the licence must be submitted.

#### 4.1.4 Proof of the licence

There is sufficient proof of the licence if the application for registration of the licence is accompanied by any of the following.

- A declaration stating that the EUTM proprietor agrees to the registration of the licence, signed by the EUTM proprietor or its representative.  
According to [Article 13\(3\)\(a\) EUTMIR](#), it is also considered sufficient proof if an application for registration of the licence is signed by both parties. This case has already been dealt with in [paragraph 4.1.2](#) above.
- The licence agreement, or an extract therefrom, indicating the parties and the EUTM being licensed, and bearing their signatures.

In many cases, the parties to the licence agreement will not wish to disclose all the details, which may contain confidential information on the licence royalties or other terms and conditions of the licence. In such cases, it is sufficient if only a part or an extract of the licence agreement is submitted, as long as it identifies the parties to the licence agreement, confirms that the EUTM in question is the subject of a licence and contains the signatures of both parties. All other elements may be omitted or blacked out.

- An uncertified statement of licence using the complete WIPO Model International Form No 1 ‘Request for Recordal of License’. The form must be signed by both the EUTM proprietor, or its representative, and the licensee, or its representative. It can be found at <http://www.wipo.int/edocs/pubdocs/en/marks/835/pub835.pdf>

It is not necessary to submit the original of a document. Original documents become part of the file and, therefore, cannot be returned to the person who submitted them. Simple photocopies are sufficient. The original document or photocopy does not need to be authenticated or legalised unless the Office has reasonable doubts as to its veracity.

## 4.2 Optional contents of the application

Articles [25\(1\)](#) and [26\(3\)](#) EUTMR

Article 32(1) CDR

Article 25 CDIR

Depending on the nature of the licence, an application for registration of the licence may contain the request to register the licence together with other indications, namely those referred to under letters a) to e) below. These indications may be individual or in any combination, for one licence (e.g. an exclusive licence limited in time) or for several licences (e.g. one exclusive licence for A as regards Member State X and another for B as regards Member State Y). They are entered in the EUTM Register by the Office only if the application for registration of the licence itself clearly requests that they be registered. Without such an explicit request, the Office will not enter in the EUTM Register any indications contained in the licence agreement that are submitted, for example, as proof of the licence.

However, if entry in the EUTM Register is requested for one or more of these indications, the following details must be indicated.

1. Where an application for the registration of a licence is limited to only some of the goods or services, the goods or services for which the licence has been granted must be indicated.
2. Where an application is for the registration of a licence as a territorially limited licence, the application must indicate the part of the European Union for which the licence has been granted. A part of the European Union may consist of one or



several Member States or one or several administrative districts within a Member State.

3. Where registration of an exclusive licence is sought, a statement to this effect must be made in the application for registration.
4. Where the registration of a licence granted for a limited period of time is sought, the expiry date of the licence must be specified. Furthermore, the date of the commencement of the licence may be indicated.
5. Where the licence is granted by a licensee whose licence is already entered in the EUTM Register, the application for registration may indicate that it is for a sublicense. Sublicences cannot be registered without first registering the main licence.

### 4.3 Examination of specific formalities (licences)

[Article 26\(4\) EUTMR](#)

Article 24(3) CDIR

Where an application for the registration of a licence has been made jointly by the EUTM proprietor and the licensee, the Office will communicate with the EUTM proprietor and send a copy to the licensee.

Where the licensee has also made and signed the application, it will not be allowed to contest the existence or scope of the licence.

Where the application for registration of the licence is filed by the EUTM proprietor alone, the Office will not inform the licensee.

The Office will inform the applicant in writing of any deficiencies in the application. If the deficiencies are not remedied within the time limit established in that communication, which will normally be 2 months following the date of the notification, the Office will reject the application.

### 4.4 Examination of optional elements (licences)

[Article 26 EUTMR](#)

Article 25 CDIR

Where an application for the registration of a licence specifies that the licence be registered as one of the following:

- an exclusive licence;
- a temporary licence;
- a territorially limited licence;
- a licence limited to certain goods or services; or

- a sublicense,

the Office will examine whether the indications mentioned in [paragraphs 2.4](#) and [4.1](#) above are indicated.

As far as the indication ‘exclusive licence’ is concerned, the Office will accept only this term and not any other wording. If ‘exclusive licence’ is not expressly indicated, the Office will consider the licence to be non-exclusive.

Where an application for registration indicates that it is for a licence limited to certain goods or services covered by the EUTM, the Office will check whether the goods and services are properly grouped and are actually covered by the EUTM.

As far as a sublicense is concerned, the Office will check whether it has been granted by a licensee whose licence has already been entered in the EUTM Register. The Office will refuse the registration of a sublicense when the main licence has not been entered in the EUTM Register. However, the Office will not check the validity of an application for the registration of a sublicense as an exclusive licence when the main licence is not an exclusive licence. Nor will it examine whether the main licence contract excludes granting sublicences.

It is the duty of the applicant for the registration of a licence not to conclude and register incompatible contracts and to request the cancellation or modification of entries in the Register that are no longer valid. For example, if an exclusive licence has been registered without limitation as to the goods and the territory, and the registration of another exclusive licence is applied for, the Office will register that second licence, even where both licences seem incompatible at first sight.

Parties are, furthermore, encouraged to update all EUTM Register information regularly and swiftly by cancelling or modifying existing licences (see [paragraph 3](#) above).

[Article 25\(1\)](#), and [Article 26\(3\) and \(4\) EUTMR](#)

Article 32(1) CDR

Articles 24(3) and 25 CDIR

If the indications mentioned in [paragraph 4.2](#) above are missing, the Office will invite the applicant for the registration of the licence to submit the supplementary information. If the applicant does not reply to that communication, the Office will not take into account the abovementioned indications and will register the licence without mentioning them.

## 4.5 Registration procedure and publication (licences)

Article [25\(5\)](#) and Articles [111\(3\)\(j\)](#) and [116\(1\)\(a\)](#) EUTMR

Article 32(5) CDR

Article 69(3)(t) and Article 70(2) CDIR

The Office will enter the licence in the EUTM Register and publish it in the EUTM Bulletin.

Where applicable, the entry in the EUTM Register will only mention that the licence is:

- an exclusive licence;
- a temporary licence;
- a territorially limited licence;
- a sublicense; or
- a licence limited to certain goods or services covered by the EUTM.

The following details will not be published:

- the period of validity of a temporary licence;
- the territory covered by a territorially limited contract;
- the goods and services covered by a partial licence.

[Article 111\(6\) EUTMR](#)

Article 69(5) CDIR

The Office will notify the applicant for a registration of a licence of the registration thereof.

When an application for registration of a licence was filed by the licensee, the Office will also inform the EUTM proprietor of the registration of the licence.

## 4.6 Transfer of a Licence

### 4.6.1 Provision for the transfer of a licence

[Article 25\(5\) EUTMR](#)

Article 32(5) CDR

A licence concerning an EUTM may be transferred. The transfer of a licence is different from the transfer of a sublicense insofar as, in the former, the licensee loses all its rights under the licence and is replaced by a new licensee, whereas, in the case of the transfer of a sublicense, the main licence remains in force. Likewise, the transfer of a

licence is different from a change of name of the owner where no change of ownership is implied (see [the Guidelines, Part E, Register Operations, Section 3, EUTMs and RCDs as Objects of Property, Chapter 1, Transfer](#)).

#### 4.6.2 Applicable rules

[Article 26\(1\) and \(5\)](#) and [Annex I A\(26\)\(b\) EUTMR](#)

Article 24(1) and (3) CDIR

Annex (18)(b) CDFR

The procedure for the registration of a transfer of a licence follows the same rules as for an application for registration of a licence.

The transfer of a licence is subject to the payment of a fee. [Paragraph 2.3](#) above applies *mutatis mutandis*.

To the extent that a declaration by or signature of the EUTM proprietor is required in accordance with the rules, its place will be taken by a declaration by or signature of the registered licensee (the former licensee).

## 5 Rights *in Rem* - Special Provisions

### 5.1 Requirements concerning proof

[Article 19](#) and [Article 26\(1\) EUTMR](#)

Articles [2\(1\)\(b\)](#) and [13\(3\)\(a\)](#) EUTMIR

Article 27 CDR

Article 1(1)(b), Articles 23(4) and 24(1) CDIR

#### 5.1.1 Application submitted by the EUTM proprietor alone

When an application for the registration of a right *in rem* is made by the EUTM proprietor alone, it must be signed by the EUTM proprietor. In the case of co-ownership, all co-owners must sign or appoint a common representative.

The signature of the EUTM proprietor constitutes proof of the right *in rem*. Consequently, no additional proof of the right *in rem* is necessary.

The Office will inform the pledgee when the right *in rem* is registered in the EUTM Register.

Where the pledgee files a statement with the Office to oppose the registration of the right *in rem*, the Office will forward the statement to the EUTM proprietor for information purposes only. The Office will not take any further action on the statement. Following the registration of the right *in rem*, any pledgee that disagrees with the registration of the right *in rem* may request the cancellation or modification of the registration of the right *in rem* (see [paragraph 3](#) above).

The Office will not take into account whether the parties have agreed to register a right *in rem* contract at the Office. Any dispute regarding the right *in rem* is a matter that must be resolved between the parties concerned under the relevant national law ([Article 19 EUTMR](#)).

#### 5.1.2 Application submitted jointly by the EUTM proprietor and the pledgee

When an application for the registration of the right *in rem* is submitted jointly by the EUTM proprietor and the pledgee, it must be signed by both parties. In the case of co-ownership, all co-owners must sign or appoint a common representative.

In this case, the signature of both parties constitutes proof of the right *in rem*.

Where there is a formal deficiency regarding the signature of the pledgee or regarding its representative, the application will still be accepted as long as it would have been acceptable if it had been submitted by the EUTM proprietor alone.

The same applies where there is a deficiency regarding the signature of the EUTM proprietor or its representative, but where the application would have been acceptable if it had been submitted by the pledgee alone.

#### 5.1.3 Application submitted by the pledgee alone

An application may also be submitted by the pledgee alone. In this case, it must be signed by the pledgee and proof of the right *in rem* must be submitted.

#### 5.1.4 Proof of the right *in rem*

There is sufficient proof of the right *in rem* if the application for registration of the right *in rem* is accompanied by any of the following.

- A declaration signed by the EUTM proprietor stating that it agrees to the registration of the right *in rem*.  
According to [Article 13\(3\)\(a\) EUTMIR](#), it is also considered sufficient proof if an application for registration of the right *in rem* is signed by both parties. This case has already been dealt with in [paragraph 5.1.2](#) above.
- The right *in rem* contract, or an extract therefrom indicating the EUTM at issue and the parties, and bearing their signatures.  
It is sufficient if the right *in rem* contract is submitted. In many cases, the parties to the right *in rem* contract will not wish to disclose all the details of the contract, which may contain confidential information about the terms and conditions of the pledge. In

such cases, it is sufficient if only a part or an extract of the right *in rem* contract is submitted, as long as it identifies the parties to the right *in rem* contract and the EUTM that is subject to a right *in rem*, and bears the signatures of both parties. All other elements may be omitted or blacked out.

- An uncertified statement of a right *in rem*, signed by both the EUTM proprietor and the pledgee.

It is not necessary to submit the original of a document. Original documents become part of the file and, therefore, cannot be returned to the person who submitted them. Simple photocopies are sufficient. The original document or photocopy does not need to be authenticated or legalised unless the Office has reasonable doubts as to its veracity.

## 5.2 Examination of specific formalities requirements (rights *in rem*)

[Article 26\(4\) EUTMR](#)

Article 24(3) CDIR

Where an application for registration of a right *in rem* has been submitted jointly by the EUTM proprietor and the pledgee, the Office will communicate with the EUTM proprietor and send a copy to the pledgee.

Where the pledgee has also submitted and signed the application, it will not be allowed to contest the existence or scope of the right *in rem* agreement within the Office's proceedings, notwithstanding what could be established by the national laws of the Member States in this regard.

If the EUTM proprietor alleges fraud on the part of the pledgee, it must provide a final decision of the competent authority to this effect. It is not up to the Office to carry out any investigation into such a claim.

The Office will inform the applicant in writing of any deficiencies in the application. If the deficiencies are not remedied within the time limit fixed in that communication, the Office will reject the application.

### 5.3 Registration procedure and publication (rights *in rem*)

Articles [22\(2\)](#) and [26\(5\)](#) and [Article 111\(3\)\(h\)](#) and [Article 111\(6\) EUTMR](#)

Article 29(2) CDR

Article 24(4) and Article 69(3)(j) and (5) CDIR

For EUTMs, the Office will enter the right *in rem* in the EUTM Register and publish it in the EUTM Bulletin.

The Office will notify the applicant for registration of a right *in rem* of the registration thereof.

When an application for registration of a right *in rem* was filed by the pledgee, the Office will also inform the EUTM proprietor of the registration.

### 5.4 Transfer of a Right *in rem*

[Article 26\(1\) and \(5\)](#) and [Annex I A\(26\)\(d\) EUTMR](#)

Article 24(1) CDIR

Annex (18)(d) CDFR

#### 5.4.1 Provision for the transfer of a right *in rem*

A right *in rem* may be transferred.

#### 5.4.2 Applicable rules

The procedure for the registration of a transfer of a right *in rem* follows the same rules as for the registration of a right *in rem*.

The transfer of a right *in rem* is subject to the payment of a fee. [Paragraph 2.3](#) above applies *mutatis mutandis*.

To the extent that a declaration by or signature of the EUTM proprietor is required in accordance with the rules, it must be replaced by a declaration by or signature of the registered pledgee (the former pledgee).

## 6 Levies of Execution - Special Provisions

### 6.1 Requirements concerning proof

[Article 26\(1\) EUTMR](#)

[Article 2\(1\)\(b\) EUTMIR](#)

Article 1(1)(b) and Article 24(1) CDIR

#### 6.1.1 Application filed by the EUTM proprietor

When an application for the registration of a levy of execution is made by the EUTM proprietor, it must be signed by the EUTM proprietor. In the case of co-ownership, all co-owners must sign or appoint a common representative.

The Office will inform the beneficiary when the levy of execution is registered in the EUTM Register.

The beneficiary may file a statement with the Office to oppose the registration of the levy of execution. The Office will not take any further action on such a statement. Following the registration of the levy of execution, any beneficiary that disagrees with the registration of the levy of execution may request the cancellation or modification of the registration of the levy of execution (see [paragraph 3](#) above).

Any dispute regarding the levy of execution is a matter that must be resolved between the parties concerned under the applicable national law ([Article 19 EUTMR](#)).

#### 6.1.2 Application filed by the beneficiary

An application for registration of a levy of execution may also be filed by the beneficiary. In this case, it must be signed by the beneficiary.

In addition, proof of the levy of execution must be submitted.

#### 6.1.3 Proof of the levy of execution

There is sufficient proof of the levy of execution if the application for registration of a levy of execution is accompanied by a final decision of the competent national authority

In many instances, the parties to the levy of execution proceedings will not wish to disclose all the details of the judgment, which may contain confidential information. In these cases it suffices if only a part or an extract of the levy of execution judgment is submitted, as long as it identifies the parties to the levy of execution proceedings and the EUTM that is subject to the levy of execution, and confirms that the judgment is final. All other elements may be omitted or blacked out.



## 6.2 Registration procedure and publication (levy of execution)

Articles [111\(3\)\(i\)](#) and [116\(1\)\(a\)](#) EUTMR

Article 69(3)(k) and Article 70(2) CDIR

When the mark is registered, the levy of execution will be entered in the EUTM Register and published in the EUTM Bulletin.

The Office will notify the applicant for registration of a levy of execution of the registration thereof.

Where applicable, the EUTM proprietor will also be informed.

## 7 Insolvency Proceedings - Special Provisions

### 7.1 Requirements concerning proof

There is sufficient proof of the appointment of a liquidator and of the insolvency proceedings if an application for registration of the insolvency proceedings is accompanied by a final decision of the competent national authority.

It suffices if the insolvency judgment is submitted. In many instances, the parties to the insolvency proceedings will not wish to disclose all the details of the judgment, which may contain confidential information. In these cases it suffices if only a part or an extract of the judgment is submitted, as long as it identifies the parties to the proceedings. All other elements may be omitted or blacked out.

It is not necessary to submit the original of a document. Original documents become part of the file and, therefore, cannot be returned to the person who submitted them. Simple photocopies are sufficient. The original document or photocopy does not need to be authenticated or legalised unless the Office has reasonable doubts as to its veracity.

### 7.2 Registration procedure and publication (insolvency proceedings)

Articles [111\(3\)\(i\)](#) and [116\(1\)\(a\)](#) EUTMR

Article 69(3)(k) and Article 70(2) CDIR

When the mark is registered, the insolvency proceedings will be entered in the EUTM Register and published in the EUTM Bulletin. The publication contains the EUTM registration number(s), the name of the authority requesting the entry in the EUTM

Register, the date and number of the entry and the publication date of the entry in the EUTM Bulletin.

The Office will notify the applicant for registration of insolvency proceedings of the registration thereof.

The liquidator's contact details are recorded as the EUTM proprietor's 'correspondence address' in the Office's database, and third parties may consult the full details of the insolvency proceedings through an application for inspection of files (see [the Guidelines, Part E, Register Operations, Section 5, Inspection of Files](#)).

## 8 Procedures for Registered Community Designs

Articles 27, 29, 30, 31, 32, and 33 and Article 51(4) CDR

Articles 24 to 26 and Article 27(2) CDIR

Annex (18) and (19) CDFR

The legal provisions contained in the CDR, CDIR and CDFR in respect of licences, rights *in rem*, levies of execution and insolvency proceedings correspond to the respective provisions in the EUTMR, EUTMDR and EUTMIR.

Therefore, both the legal principles and the procedure in respect of the registration, cancellation or modification of trade mark licences, rights *in rem*, levies of execution or insolvency proceedings apply *mutatis mutandis* to RCDs, except for the following specific procedures.

### 8.1 Multiple applications for RCDs

Article 37 CDR

Article 24(1) CDIR

An application for the registration of licences, rights *in rem* and levies of execution for an RCD may be in the form of a multiple application containing several designs.

For the purposes of the legal effect of licences, rights *in rem* and levies of execution, as well as of the procedure for registering licences, rights *in rem* and levies of execution, the individual designs contained in a multiple application will be dealt with as if they were separate applications. This continues to apply after registration of the designs contained in the multiple application.

In other words, each design contained in a multiple application may be licensed, pledged or levied independently of the others.

For **licences** specifically, the optional indications as to the kind of licence and the procedure for their examination referred to in [paragraphs 4.2](#) and [4.4](#) above (with the

exception of a licence limited to some products, which is not possible), apply to each of the individual designs contained in a multiple application separately and independently.

Annex (18) and (19) CDFR

The fee of EUR 200 for the registration of a licence, a right *in rem*, or a levy of execution; the transfer of a licence or right *in rem*; or the cancellation of a licence, a right *in rem*, or levy of execution applies per design and not per multiple application. The same is true for the ceiling of EUR 1 000 if multiple applications are submitted.

## 8.2 Entitlement proceedings for RCDs

Article 15 CDR

Article 69(3)(f), (g) and (h) and Article 80(c) CDIR

RCD applications and registrations may be the subject of entitlement proceedings and subsequent changes in ownership.

If an RCD has been applied for or registered in the name of a person who is not entitled to it under Article 14 CDR, the person entitled to it under that provision may claim recognition as the RCD's legitimate holder.

Moreover, where a person is jointly entitled to the RCD, that person may, in accordance with Article 15(2) CDR, claim recognition as joint holder.

The following entries in the Register are specific to RCDs:

- the mention that legal entitlement proceedings have been initiated;
- the final decision or any other termination of the entitlement proceedings;
- any change in the RCD's ownership resulting from the final decision.

The applicant for the institution of entitlement proceedings can request that the mention that legal proceedings have been initiated be entered in the Register.

Once the legal proceedings have concluded, the person recognised as the RCD's legitimate holder can request the entry of the final decision and the change of ownership in the Register.

### 8.2.1 Requirements for an application for registration of entries relating to entitlement proceedings

[Paragraph 2](#), concerning the requirements for an application for registration, applies by analogy, with the following exceptions.

#### Fees

There is no fee for registering any of the entries relating to entitlement proceedings.

#### Parties to the proceedings

An application for the registration of a mention that entitlement proceedings have been initiated may be filed by:

- the RCD holder(s); or
- the applicant for the institution of entitlement proceedings.

An application for the registration of the entry of the final decision or any other termination on the entitlement proceedings, or for a change in ownership of the RCD resulting from a final decision may be filed by:

- the RCD holder(s); or
- the person recognised as the legitimate holder of the RCD.

Where the Office receives documents relating to such proceedings from third parties or authorities such as national Courts, it will forward the documents to the RCD holder with a notice indicating that such a right could be entered in the RCD Register upon request. Additionally, if the person recognised as the legitimate holder is fully identified by their contact details, the same notice will also be sent.

#### Mandatory indications

The application for the mention that legal entitlement proceedings have been initiated, or terminated, must contain the following information:

- the registration number of the RCD concerned. If the application relates to several RCDs, each of the registration numbers must be indicated;
- the holder's name, address and nationality, as well as the State in which it is domiciled or has its seat or an establishment. However, if the Office has already assigned an ID number to the holder, it is sufficient to indicate this number together with the name.

The application for a change of ownership must additionally contain the following information:

- the name, address and nationality, as well as the State in which it is domiciled or has its seat or an establishment of the person recognised as the legitimate holder of the RCD. However, if the Office has already assigned an ID number to the legitimate holder, it is sufficient to indicate this number together with the name.

### 8.2.2 Requirements concerning proof

There is sufficient proof for entry of entitlement proceedings in the Register if the application for registration is accompanied by evidence that entitlement proceedings have been initiated before the competent authority. For entry of the final decision or other termination of entitlement proceedings in the Register, the application for registration must be accompanied by evidence that the entitlement proceedings have concluded, such as a final decision of the competent authority.

## 9 Procedures for international trade marks

Rules 20 and 20bis Regulations under the Madrid Protocol.

### 9.1 Recording of licences

The Madrid System allows for the recording of **licences** against an international registration.

All requests for the recording of a licence should be submitted on form [MM13](#) either:

- directly to the International Bureau by the recorded holder; or
- through the office of the contracting party of the recorded holder or through the office of a contracting party in respect of which the licence is granted; or
- through the office of the licensee.

The request cannot be submitted directly to the International Bureau by the licensee. The Office's application form should **not** be used.

Detailed information on the recording of licences can be found in paragraph 703 and the following ones of the [Guide to the Madrid System](#). For further information on international trade marks, see the Guidelines, [Part M, International Marks](#).

### 9.2 Recording of rights *in rem*, levies of execution or insolvency proceedings

The Madrid System allows for the recording of **rights *in rem*, levies of execution or insolvency proceedings** against an international registration (see Rule 20 of Regulations under the Madrid Protocol). For the convenience of users, form [MM19](#) is available for requesting the recording of a restriction of the holder's right of disposal in the International Register. The use of this form is strongly recommended to avoid irregularities.

Requests should be submitted either:

- directly to the International Bureau by the recorded holder; or
- to the office of the contracting party of the registered holder; or
- to the office of a contracting party to whom the right *in rem*, levy of execution or insolvency is granted; or
- to the office of the contracting party of the pledgee, beneficiary or liquidator.

The request cannot be submitted directly to the International Bureau by the pledgee, beneficiary or liquidator. The Office's application form should **not** be used.

Detailed information on the registration of rights *in rem*, levies of execution or insolvency proceedings can be found in paragraphs 698 and the following ones of the

[Guide to the Madrid System](#). For further information on international trade marks, see the Guidelines, [Part M, International Marks](#).

**GUIDELINES FOR EXAMINATION**

**EUROPEAN UNION**  
**INTELLECTUAL PROPERTY OFFICE**  
**(EUIPO)**

***Part E***

***Register operations***

***Section 4***

***Renewal***

## Table of Contents

<b>1 Fraud Warning</b> .....	<b>1595</b>
<b>1.1 Private companies sending misleading invoices</b> .....	<b>1595</b>
<b>1.2 Renewal by unauthorised third persons</b> .....	<b>1595</b>
<b>2 Terms of Registration of European Union Trade Marks</b> .....	<b>1595</b>
<b>3 Terms of Protection of Registered Community Designs</b> .....	<b>1596</b>
<b>4 Notification of Expiry of Registration</b> .....	<b>1596</b>
<b>5 Renewal of an EUTM Application</b> .....	<b>1597</b>
<b>6 Renewal of an RCD Application</b> .....	<b>1597</b>
<b>7 Fees and Other Formal Requirements for the Request for Renewal</b> ...	<b>1598</b>
<b>7.1 Persons who may submit a request for renewal</b> .....	<b>1598</b>
<b>7.2 Content of the request for renewal</b> .....	<b>1599</b>
7.2.1 Name and address and other particulars of the person submitting a request for renewal.....	1600
7.2.1.1 Request filed by the proprietor/holder.....	1600
7.2.1.2 Request filed by a person authorised to do so by the proprietor/holder.....	1600
7.2.2 Registration number.....	1600
7.2.3 Indication as to the extent of the renewal.....	1600
<b>7.3 Languages</b> .....	<b>1601</b>
<b>7.4 Time limits</b> .....	<b>1602</b>
7.4.1 Six-month period for renewal before expiry (basic period).....	1602
7.4.2 Six-month grace period following expiry (grace period).....	1602
<b>7.5 Fees</b> .....	<b>1603</b>
7.5.1 Fees payable for EUTMs.....	1603
7.5.2 Fees payable for RCDs.....	1604
7.5.3 Time limit for payment.....	1605
7.5.4 Payment by third parties.....	1605
7.5.5 Fee refund.....	1606
<b>8 Procedure Before the Office</b> .....	<b>1606</b>
<b>8.1 Examination of formal requirements</b> .....	<b>1606</b>
8.1.1 Observation of time limits.....	1606
8.1.1.1 Payment during the basic period or the grace period.....	1606
8.1.1.2 Insufficient payments and payment after the expiry of the grace period.....	1607



8.1.1.3 Situation where the requester holds a current account.....	1608
8.1.2 Compliance with formal requirements.....	1608
8.1.2.1 Renewal requested by an authorised person.....	1608
8.1.2.2 Further requirements.....	1609
<b>8.2 Items not to be examined.....</b>	<b>1610</b>
<b>9 Partial Renewals of EUTMs.....</b>	<b>1610</b>
<b>10 Entries in the Register.....</b>	<b>1611</b>
<b>11 Date of Effect of Renewal or Expiry, Conversion.....</b>	<b>1612</b>
11.1 Date of effect of renewal.....	1612
11.2 Conversion of lapsed EUTMs.....	1613
<b>12 Renewal of International Marks Designating the EU.....</b>	<b>1613</b>
<b>13 Renewal of International Design Registrations Designating the EU.</b>	<b>1614</b>

## 1 Fraud Warning

### 1.1 Private companies sending misleading invoices

The Office is aware that users are receiving an increasing amount of unsolicited mail from companies requesting payment for trade mark and design services such as renewal.

A list of letters from firms or registers that users have complained are misleading is published on the Office website. These services are not connected with any official trade mark or design registration services provided by IP offices or other public bodies within the European Union such as the EUIPO.

If a user receives a letter or invoice, he or she should carefully check what is being offered, and its source. It must be pointed out that the **EUIPO never sends invoices to users or letters requesting direct payment for services** (see [the Guidelines, Part A, General Rules, Section 3, Payment of Fees, Costs and Charges](#)).

### 1.2 Renewal by unauthorised third persons

The Office is also aware that fraudsters have targeted the e-renewal module. If, upon filing a request for e-renewal, a user discovers that the mark is 'blocked', as renewal has already been requested, they should contact the Office.

## 2 Terms of Registration of European Union Trade Marks

Articles [1](#), [32](#), [52](#) and [Article 41\(5\) and \(8\) EUTMR](#)

The term of registration of a European Union trade mark (EUTM) is 10 years from the **filing date** of the application. For example, an EUTM with a filing date of 16/04/2020 will expire on 16/04/2030.

The filing date of the application is determined according to Articles [31](#) and [32](#) EUTMR and [Article 41\(5\) and \(8\) EUTMR](#).

A registration may be renewed indefinitely for further periods of 10 years.

### 3 Terms of Protection of Registered Community Designs

Articles 12 and 38 CDR

Article 10 CDIR

The term of protection of a registered Community design (RCD) is 5 years from the **date of filing** of the application (Article 12 CDR). For example, an RCD with a filing date of 16/04/2020 will expire on 16/04/2025.

The date of filing of the application is determined according to Article 38 CDR and Article 10 CDIR (see [the Guidelines for Examination of Registered Community Designs, Examination of Applications for Registered Community Designs, paragraph 3, Allocation of a Filing Date](#)).

A registration may be renewed for periods of 5 years each, up to a total of 25 years from the date of filing.

### 4 Notification of Expiry of Registration

[Article 53\(2\) EUTMR](#)

[Article 60\(3\)](#) and [Article 66 EUTMDR](#)

Article 13(2) CDR

Articles 21 and 63 CDIR

At least 6 months before the expiry of the registration, the Office will inform:

- the registered proprietor/holder of the EUTM/RCD, and
- any person having a registered right in respect of the EUTM/RCD

that the registration is approaching expiry. Persons having a registered right include the holders of a registered licence, the proprietors of a registered right *in rem*, the creditors of a registered levy of execution or the authority competent to act on behalf of the proprietor/holder in insolvency procedures.

Failure to give such information does not affect the expiry of the registration and does not involve the responsibility of the Office.

## 5 Renewal of an EUTM Application

[Article 53\(2\) EUTMR](#)

[Annex I A\(19\) EUTMR](#)

In the exceptional circumstance where an application has not yet matured to registration because of pending proceedings, the Office will not send the notice referred to in Article 53(2) EUTMR. The applicant is not obliged to renew its application during proceedings that last for more than 10 years and where the outcome of registration is uncertain. Only once the trade mark is registered will the Office invite the owner to renew the EUTM and pay the relevant renewal fees due. The owner will then have 4 months to pay the renewal fee (including any additional class fees). The surcharge for the renewal fee of 25 % pursuant to [Annex I A\(19\) EUTMR](#) does not apply. If the renewal fee is not paid within the time limit given, the Office will issue a notice that the registration has expired. The expiry will take effect from the date of registration of the EUTM.

## 6 Renewal of an RCD Application

Article 13(2) CDR

Annex to the CDFR point 12

In the exceptional circumstance where an application has not yet matured to registration because of pending proceedings, the Office will not send the notice referred to in Article 13(2) CDR. The applicant is not obliged to renew its application during proceedings that last for more than 5 years and where the outcome of registration is uncertain. The Office will only invite the owner to renew the RCD and pay the renewal fee once the design has been registered. The owner will then have 4 months to pay the renewal fee. The surcharge for the renewal fee of 25 % pursuant to point 12 of the Annex to the CDFR does not apply. If the renewal fee is not paid within the time limit given, the Office will issue a notice that the registration has expired. The expiry will take effect from the date of registration of the RCD.

## 7 Fees and Other Formal Requirements for the Request for Renewal

Articles [63](#) and [64](#) EUTMDR

Article 22(8) and Articles 65, 66 and 67 and Article 68(1)(e) CDIR

Decision No [EX-20-9](#) of the Executive Director of the Office of 03/11/2020

The general rules concerning communications to the Office apply (see [the Guidelines, Part A, General Rules, Section 1, Means of Communication, Time Limits](#)), which means that the request may be submitted in the following ways.

- By electronic means available on the EUIPO website (e-renewal available via the User Area). For EUTMs, there is a reduction of EUR 150 on the basic renewal fee for an individual mark using e-renewal (EUR 300 for a collective mark). Entering the name and surname in the appropriate place on the electronic form is deemed to be a signature. In addition, using e-renewal offers additional advantages such as the receipt of immediate electronic confirmation of the renewal request automatically or the use of the renewal manager feature to complete the form quickly for as many EUTMs/RCDs as needed.
- By transmitting a signed original form electronically, by post or by courier (see [the Guidelines, Part A, General Rules, Section 1, Means of Communication, Time Limits](#)). A standard form is available on request to the Office. Forms have to be signed but annexes need not be signed.

Following Decision No [EX-20-9](#) of the Executive Director of the Office of 03/11/2020, EUTM and RCD renewals must be made via e-renewal, post or courier. In cases where technical malfunction prevents e-renewal, renewals by one of the two alternative electronic back-up measures will be treated by the Office only when received within the last three working days before the expiry of: (i) the deadline for renewal or (ii) the extended deadline for renewal.

A single application for renewal may be submitted for two or more EUTMs/RCDs (including RCDs that form part of the same multiple registration), upon payment of the required fees for each EUTM/RCD.

### 7.1 Persons who may submit a request for renewal

Articles [20\(12\)](#) and [53\(1\)](#) EUTMR

Article 13(1) and Article 28(c) CDR

The request for renewal may be submitted by:

1. the registered proprietor/holder of the EUTM/RCD;

2. where the EUTM/RCD has been transferred, the successor in title as from the point in time a request for registration of the transfer has been received by the Office;
3. any person expressly authorised by the proprietor/holder of the EUTM/RCD to do so. Such a person may, for instance, be a registered licensee, a non-registered licensee or any other person who has obtained the authorisation of the proprietor/holder to renew the EUTM/RCD.

Professional representation is not mandatory for renewal.

When the renewal request is submitted by a person other than the registered proprietor/holder or its representative on file, an authorisation will have to exist in its favour; however, it does not need to be filed with the Office unless the Office requests it.

When a person other than the proprietor/holder or its representative on file sends a direct payment or submits a request for renewal with the indication that payment will be made by bank transfer, the proprietor/holder will be informed that the renewal will be processed once payment has been received. If no reply is received from the proprietor/holder, or no objection is raised to the renewal, the Office will validate the payment once it reaches the Office and the renewal will be processed.

If the Office receives fees from two different sources, neither of which is the proprietor/holder or its representative on file, the proprietor/holder will be contacted in order to ascertain who is authorised to file the renewal request. Where no reply is received from the proprietor/holder, the Office will validate the payment that reached the Office first (12/05/2009, [T-410/07](#), Jurado, EU:T:2009:153, § 33-35; 13/01/2008, [R 989/2007-4](#), ELITE GLASS-SEAL, § 17-18).

## 7.2 Content of the request for renewal

[Article 53\(4\) EUTMR](#)

Article 22(1) CDIR

The request for renewal must contain the following: name and address of the person requesting renewal and the registration number of the EUTM/RCD to be renewed. In the case of an EUTM renewal, the extent of the renewal is deemed to cover the full specification by default.

Payment alone can constitute a valid request for renewal, providing such payment reaches the Office and contains the name of the payer, the registration number of the EUTM/RCD and an indication that it is a request for renewal. In such circumstances, no further formalities need to be complied with (see [the Guidelines, Part A, General Rules, Section 3, Payment of Fees, Costs and Charges](#)). Where this option is relied on in EUTM renewals, the payment must be of the renewal fee laid out in [Annex I A, paragraphs \(11\) or \(15\) EUTMR](#) and not of the discounted fee for renewal by electronic means pursuant to [Annex I A, paragraphs \(12\) or \(16\)](#).

Consequently, payment alone cannot constitute a valid request for e-renewal. The discounted fee may only be relied on where a renewal application is submitted by electronic means, as such payment must be accompanied by a valid e-renewal application form.

#### 7.2.1 Name and address and other particulars of the person submitting a request for renewal

[Article 2\(1\)\(b\) and \(e\) EUTMIR](#)

Article 22(1)(a) CDIR

##### 7.2.1.1 Request filed by the proprietor/holder

Where the request is filed by the EUTM/RCD proprietor/holder, its name must be indicated.

##### 7.2.1.2 Request filed by a person authorised to do so by the proprietor/holder

Where the request for renewal is filed by a person authorised by the proprietor/holder to do so, the name and address or the ID number and name of the authorised person in accordance with [Article 2\(1\)\(e\) EUTMIR](#) or Article 22(1)(a) CDIR must be indicated.

If the selected payment method is bank transfer, a copy of the renewal request is sent to the proprietor/holder.

#### 7.2.2 Registration number

[Article 53\(4\)\(b\) EUTMR](#)

Article 22(1)(b) CDIR

The EUTM/RCD registration number must be indicated.

#### 7.2.3 Indication as to the extent of the renewal

[Article 53\(4\) EUTMR](#)

Article 22(1)(c) CDIR

For EUTMs, renewal is deemed to cover the entire specification of goods and/or services of the EUTM by default.

Where renewal is requested for only some of the goods or services for which the mark is registered:

- those classes or those goods and services for which renewal is requested must be indicated in a clear and unequivocal way.

Or, alternatively:

- those classes or those goods and services for which renewal is not requested must be indicated in a clear and unequivocal way.

The e-renewal platform only allows for deleting (i.e. not renewing) entire classes; it does not allow for the partial renewal of only some goods or services within a class (i.e. it does not allow the deletion of some of the goods or services listed in a specific class at the time of the renewal). Therefore, where renewal is required for only **some goods or services within a class**, the renewal application can *either* be submitted using any other means of communication accepted by the Office, *or*, the whole class can be renewed through e-renewal and a request for partial surrender can be submitted pursuant to [Article 57 EUTMR](#) for those goods or services that the proprietor wishes to remove from the EUTM.

For RCDs, in the case of a multiple registration, an indication that renewal is requested for all the designs covered by the multiple registration or, if the renewal is not requested for all the designs, an indication of the file number for which it is requested. If nothing is indicated, the renewal is deemed to be for all the designs by default.

### 7.3 Languages

[Article 146\(6\) EUTMR](#)

Article 68 and Article 80(b) and (c) CDIR

The request for renewal may be filed in any of the five languages of the Office. The chosen language becomes the language of the renewal proceedings. However, when the request for renewal is filed by using the form provided by the Office pursuant to [Article 65\(1\)\(g\) EUTMDR](#) or Article 68(1)(e) CDIR, such a form may be used in any of the official languages of the European Union, provided that the form is completed in one of the languages of the Office, as far as textual elements are concerned. This concerns, in particular, the list of goods and services in the event of a partial renewal of an EUTM.



## 7.4 Time limits

[Article 52](#) and [Article 53\(3\) EUTMR](#)

[Article 69\(1\) EUTMDR](#)

Article 13(3) CDR

Articles 56 and 58 CDIR

Communication No [2/16](#) of the President of the Office of 20/01/2016

### 7.4.1 Six-month period for renewal before expiry (basic period)

For EUTMs, the request for renewal and the renewal fee must be submitted in the 6-month period prior to the expiry of the registration.

For example, where the EUTM has a filing date of 10/06/2010, the day on which protection ends will be 10/06/2020. Therefore, a request for renewal must be introduced and the renewal fee paid as from 10/12/2019 until 10/06/2020 or, where this is a Saturday, Sunday or other day on which the Office is closed, or does not receive ordinary mail within the meaning of [Article 69\(1\) EUTMDR](#), the first following working day on which the Office is open to the public and receives ordinary mail.

For RCDs, the request for renewal and the renewal fee must be submitted within a period of 6 months ending on the last day of the month in which protection ends.

For example, where the RCD has a filing date of 01/04/2015, the basic period will run up to and including the last day of the month in which protection ends, namely 30/04/2020. Therefore, a request for renewal must be submitted and the renewal fee paid between 01/11/2019 and 30/04/2020 or, where the latter date is a Saturday, Sunday or other day on which the Office is closed or does not receive ordinary mail within the meaning of Article 58(1) CDIR, the first following working day on which the Office is open to the public and does receive ordinary mail.

### 7.4.2 Six-month grace period following expiry (grace period)

Where the EUTM/RCD is not renewed within the basic period, the request may still be submitted and the renewal fee may still be paid, upon payment of an additional fee (see [paragraph 7.5](#) below), within a further period of 6 months.

For example, where the EUTM has a filing date of 10/06/2010, the day on which protection ends will be 10/06/2020. Therefore, the grace period during which a request for renewal may still be introduced upon payment of the renewal fee plus the additional fee is counted from the day after 10/06/2020, namely from 11/06/2020, and ends on 10/12/2020 or, if 10/12/2020 is a Saturday, Sunday or other day on which the Office is closed, or does not receive ordinary mail within the meaning of [Article 69\(1\) EUTMDR](#), the first following working day on which the Office is open to the public and receives

ordinary mail. This also applies if the above example 11/06/2020 was a Saturday or Sunday; the rule that a time limit to be observed vis-à-vis the Office is extended until the next working day applies only once and to the end of the basic period, and not to the starting date of the grace period.

For example, where the RCD has a filing date of 01/04/2015, the basic period will run up to and including the last day of the month in which protection ends, namely 30/04/2020. Therefore, a request for renewal must be submitted and the renewal fee paid between 01/11/2019 and 30/04/2020 or, where the latter date is a Saturday, Sunday or other day on which the Office is closed or not receiving ordinary mail within the meaning of Article 58(1) CDIR, the first following working day on which the Office is open to the public and receiving ordinary mail. The grace period would then run from 01/05/2020 up to and including 31/10/2020 (or the first working day thereafter).

During the 6-month grace period, the only action that may be carried out in an EUTM or RCD is the payment of the renewal fee (including the payment of the additional fee for late payment). In the event the Office receives any other request during the grace period, such as a transfer, registration of a licence, surrender, change of name, etc. or any other request for entry into the Registers, the Office will put the request on hold until the renewal fee is paid. Only once the renewal fee is paid in full, and the EUTM or RCD is officially renewed, will the Office examine any requests that had been placed on hold.

## 7.5 Fees

As regards the calculation of the amount of the renewal fees, the due date for the renewal fees is the date of expiry of the registration ([Article 53\(3\) EUTMR](#) and Article 13(3) CDR). This principle applies regardless of the moment at which renewal is actually requested and paid for.

### 7.5.1 Fees payable for EUTMs

[Article 53\(3\)](#) and [Annex I A\(11\), \(12\), \(13\), \(14\), \(15\), \(16\), \(17\), \(18\) and \(19\) EUTMR](#)

Communication No [2/16](#) of the President of the Office of 20/01/2016

The fees payable for the renewal of an EUTM consist of:

- a basic fee that covers the first class of goods/services;
- one or more class fees for each class of goods/services exceeding the first one;
- any additional fee applicable for late payment of the renewal fee or late submission of the request for renewal.

The amount of the renewal fee is as follows.

Basic fee (by e-renewal):

- for an individual mark: EUR 850, and
- for a collective or certification mark: EUR 1 500.

Basic fee (other than by e-renewal):

- for an individual mark: EUR 1 000, and
- for a collective or certification mark: EUR 1 800.

Class fees:

- for the second class: EUR 50,
- for each class exceeding two: EUR 150.

The fee must be submitted in the 6-month period prior to the expiry of the registration (see [paragraph 7.4](#) above).

The additional fee for late payment or late submission is:

- 25% of the belated renewal fee, subject to a maximum of EUR 1 500.

#### 7.5.2 Fees payable for RCDs

Article 13(3) CDR

Article 22(2) (a), (b) CDIR

Article 7(1) and Annex to the CDFR points 11 and 12

The fees payable for the renewal of an RCD consist of:

- a renewal fee, which, where several designs are covered by a multiple registration, is in proportion to the number of designs covered by the renewal;
- any additional fee applicable for late payment of the renewal fee or late submission of the request for renewal.

The amount of the renewal fee, per design, whether or not included in a multiple registration, is as follows:

- for the first renewal: EUR 90;
- for the second renewal: EUR 120;
- for the third renewal: EUR 150;
- for the fourth renewal: EUR 180.

The fee must be paid within a period of 6 months ending on the last day of the month in which protection ends (see [paragraph 7.4](#) above).

The additional fee for late payment or late submission is:

- 25% of the renewal fee.

### 7.5.3 Time limit for payment

Articles [53\(3\)](#) and [180\(3\)](#) and [Annex I A\(19\)](#) EUTMR

Article 13(3) CDR

Annex to the CDFR point 12

Article 8(c) and (h) of Decision No [EX-21-5](#) of the Executive Director of the Office of 21/07/2021.

The fee must be paid within a basic period of 6 months (for calculation of the period, see the example given in [paragraph 7.4.1](#) above).

The fee may be paid within a further grace period of 6 months (see [paragraph 7.4.2](#) above), provided that an additional fee for late payment is paid, which amounts to 25 % of the total renewal fee, including any class fees.

Renewal will be effected only if payment of **all** fees reaches the Office within the grace period, this includes all renewal fees, additional fees for payment within the grace period, and surcharges for late payment by bank transfer (see [Part A, Section 3, Payment of Fees, Costs and Charges, paragraph 4.1.1](#)) where applicable.

Fees that are paid **before** the start of the basic period of 6 months will not, in principle, be taken into consideration and will be refunded.

### 7.5.4 Payment by third parties

Article 6 of Decision No [EX-21-5](#) of the Executive Director of the Office of 21/07/2021.

Payment may also be made by the other persons identified in [paragraph 7.1](#) above.

Payment by debiting a current account held by a third party requires an explicit authorisation of the holder of the current account that the account can be debited for the benefit of the particular fee. In such cases, the Office will check if there is an authorisation. If there is no authorisation, a letter will be sent to the renewal applicant asking them to submit the authorisation to debit the account held by a third party. In such cases, payment is considered to be effected on the date the Office receives the authorisation.

### 7.5.5 Fee refund

[Article 53\(8\) EUTMR](#)

Article 22(7) CDIR

Renewal fees and, where applicable, the additional fee for late payment may be refunded under certain circumstances. For full information, please see the Guidelines, [Part A, General Rules, Section 3, Payment of Fees, Costs and Charges](#).

## 8 Procedure Before the Office

### 8.1 Examination of formal requirements

The examination of the request for renewal is limited to formalities and relates to the following points.

#### 8.1.1 Observation of time limits

[Article 53\(3\), \(4\) and \(8\) EUTMR](#)

Article 13(3) CDR

Article 22(3), (4) and (5) CDIR

Article 5 and Article 6(2) CDFR

##### 8.1.1.1 Payment during the basic period or the grace period

Where the request for renewal is filed and the renewal fee is paid within the basic period, the Office will record the renewal, provided that the other conditions laid down in the EUTM Regulations or CDR and CDIR are fulfilled (see [paragraph 8.1.2](#) below).

Where no request for renewal has been filed, but the payment of a renewal fee reaches the Office that contains the minimum identification elements (see [paragraph 7.2](#)), this constitutes a valid request and no further formalities need be complied with. This is pursuant to [Article 53\(4\) EUTMR](#), last sentence and Article 22(3) CDIR.

Where this option is relied on in EUTM renewals, the payment must be of the renewal fee laid out in [Annex I A, paragraphs \(11\) or \(15\) EUTMR](#) and **not of the discounted fee for renewal by electronic means** pursuant to [Annex I A, paragraphs \(12\) or \(16\)](#). Consequently, as payment alone cannot constitute a valid request for e-renewal, the fee discount may only be relied on where a renewal application is submitted by electronic means. The requester will either have to submit a valid e-renewal application

form, or pay the difference in the basic fee, in all cases before the expiry of the renewal period. Furthermore, if this is carried out during the grace period, the additional fee for late payment will also be due.

Where no request for renewal has been filed but a renewal fee has been paid that does not contain the minimum identification elements, the Office will invite the person requesting renewal to provide the missing indications. A letter will be sent out as early as is reasonably possible after receipt of the fee, so as to enable filing of the request before the additional fee becomes due.

Where a request for renewal has been submitted but the renewal fee has not been paid in full, the Office will, where possible, remind the person requesting renewal to pay the remaining part thereof within the basic renewal period and the additional fee for late payment if within the grace period.

The lack of payment is not a remediable deficiency that the Office will set the party a time limit to remedy.

In the case of incomplete payment of the fee for the renewal of an EUTM, the proprietor may, instead of paying the missing amount, restrict its request for renewal to the corresponding number of classes.

In the case of incomplete payment of the fee for the renewal of an RCD, the holder may, instead of paying the missing amount, restrict its request for renewal to the corresponding number of multiple designs.

#### 8.1.1.2 Insufficient payments and payment after the expiry of the grace period

[Article 53\(5\) and \(8\)](#) and [Article 99 EUTMR](#)

Article 22(5) CDIR

Where a request for renewal has not been submitted or is submitted only after the expiry of the grace period, or the fees have not been paid, the Office will determine that the registration has expired and will issue a notification on loss of rights to the proprietor/holder.

Where the fees received in the grace period are not paid in full (i.e. the fee received amounts to less than the required basic fee and the additional fee for late payment) or are received only after expiry of the grace period, the Office will determine that the registration has expired and will issue a notification on loss of rights to the proprietor/holder.

For EUTMs, where the insufficient fee received in the grace period covers the basic fee and the additional fee for late payment, but not all class fees, the Office will only renew the registration for some classes. The determination of which classes of goods and services are to be renewed will be made according to the following criteria.

- Where the request for renewal is expressly limited to particular classes, only those classes will be renewed.

- Where it is otherwise clear from the request which class or classes are to be covered by the request, that class or those classes will be renewed.
- The Office may contact the proprietor to ask for the class preferences in the event of partial payment.
- In the absence of other criteria, the Office will take the classes into account in the numerical order of classification, beginning with the class having the lowest number.

Where not all class fees are paid and the Office determines that the registration has expired for some of the classes of goods or services, it will issue the renewal confirmation to the proprietor, as well as a notification of loss of rights for those classes of goods or services to the proprietor. If the person concerned considers that the finding of the Office is inaccurate, he or she may, within 2 months of the notification of the loss of rights, apply for a decision on the matter.

For RCDs, where the fee paid covers the basic fee and the fee for late payment, but the fees paid are insufficient to cover all designs identified in the renewal application, the Office will only renew the registration for some designs. In the absence of an indication of the designs to be renewed, or of any other criteria for determining which designs are intended to be covered, the Office will determine the designs to be renewed by taking them in numerical order.

#### 8.1.1.3 Situation where the requester holds a current account

The Office will not debit a current account unless there is an express request for renewal. It will debit the account of the person requesting renewal.

Where the renewal applicant has a current account at the Office, the renewal fee will only be debited once a request for renewal has been filed and the renewal fee (including any class fees) will be debited on the day of receipt of the request, unless other instructions are given. In the event the request for renewal is filed during the 6-month grace period, the renewal fee and the additional fee for late payment will both be debited from the current account.

For payment by third parties, see [paragraph 7.5.4](#) above.

#### 8.1.2 Compliance with formal requirements

##### 8.1.2.1 Renewal requested by an authorised person

[Article 53\(1\) EUTMR](#)

Article 13(1) CDR

Where a renewal request is filed on behalf of the proprietor/holder, there is no need to file an authorisation. However, such an authorisation should exist in favour of the person filing the request should the Office request it.

#### 8.1.2.2 Further requirements

[Article 53\(4\) and \(7\) EUTMR](#)

Article 22(3) and (4) CDIR

Where the request for renewal does not comply with other formal requirements, namely where the name and address of the person requesting renewal has not been sufficiently indicated, where the registration number has not been indicated, where it has not been properly signed or, for EUTMs, if partial renewal was requested but the goods and services to be renewed have not been properly indicated, the Office will inform the person requesting renewal of the deficiencies found.

The Office will consider the request to be made for the renewal for all goods and services or all the designs covered by the multiple registration, unless partial renewal is expressly requested. In the event of a partial renewal, please refer to [paragraph 7.2.3](#) above.

If the request for renewal is filed by a person authorised by the proprietor/holder (see [paragraph 7.1\(c\)](#) above), the proprietor/holder will receive a copy of the deficiency notification.

[Article 53\(5\), \(8\) and Article 99 EUTMR](#)

Article 22(5) and Article 40 CDIR

Where these deficiencies are not remedied before the expiry of the relevant time limit, the Office will proceed as follows.

- If the deficiency consists of failing to indicate the goods and services of the EUTM to be renewed, the Office will renew the registration for all the classes for which the fees have been paid, and if the fees paid do not cover all the classes of the EUTM registration, the determination of which classes are to be renewed will be made according to the criteria set out in [paragraph 8.1.1.2](#) above. The Office will issue, at the end of the grace period, a notification of loss of rights for those classes of goods or services the Office deems expired to the proprietor.
- If the deficiency consists of the proprietor's/holder's failure to respond to a request for clarification of who the authorised person is, the Office will accept the request for renewal filed by the authorised representative on file. If neither of the requests for renewal has been filed by an authorised representative on file, the Office will accept the renewal request that was first received by the Office.
- If the deficiency lies in the fact that there is no indication of the designs to be renewed, and the fees paid are insufficient to cover all the designs for a multiple application for which renewal is requested, the determination of which designs are to be renewed will be made according to the criteria set out in [paragraph 8.1.1.2](#) above. The Office will determine that the registration has expired for all designs for which the renewal fees have not been paid in part or in full.



- In the case of the other deficiencies, it will determine that the registration has expired and will issue a notification of loss of rights to the proprietor/holder and, where applicable, the person requesting renewal.

The person concerned may apply for a decision on the matter under [Article 99 EUTMR](#) or Article 40(2) CDIR within 2 months.

## 8.2 Items not to be examined

No examination will be carried out on renewal for the registrability of the mark or design, nor will any examination be carried out as to whether the EUTM has been put to genuine use.

No examination will be carried out by the Office on renewal as to the correct classification of the EUTM, nor will a registration be reclassified that has been registered in accordance with an edition of the Nice Classification that is no longer in force at the point in time of renewal. All of this is without prejudice to the application of [Article 57 EUTMR](#).

The Office will not examine the product classification of the RCD nor will an RCD be reclassified that was registered in accordance with an edition of the Locarno Classification no longer in force at the time of renewal. Such reclassification will not even be available at the holder's request.

## 9 Partial Renewals of EUTMs

[Article 53\(4\)\(c\) and Article 53\(8\) EUTMR](#)

[Annex I A\(19\) EUTMR](#)

An EUTM may be renewed in part for some of the goods and/or services for which it has been registered.

A partial renewal is not a partial surrender for those goods and/or services for which the EUTM has not been renewed.

An EUTM may be partially renewed several times during the initial basic renewal period of 6 months or during the 6-month grace period. See to this extent 22/06/2016, [C-207/15 P](#), CVTC, EU:C:2016:465.

For each partial renewal, the full amount of the corresponding fee has to be paid, and in the event a partial renewal request is submitted within the grace period, the additional fee for the late payment of the renewal fee must also be paid, namely 25 % of the belated renewal fee (subject to a maximum of EUR 1 500).

For example:

An EUTM registration has 10 classes.

If within the basic period the Office receives an e-renewal request for 5 classes (out of the 10) the fees payable would be:

Basic e-renewal fee (including 1 class):	EUR 850
Second class:	EUR 50
Remaining classes (150 EUR x 3):	EUR 450
<b>Total renewal fee:</b>	<b>EUR 1 350</b>

If, within the grace period, the Office receives a new renewal request for two more classes of the registration, the fees payable would be:

Additional classes (EUR 150 x 2):	EUR 300
25 % surcharge of the belated fee:	EUR 75
<b>Total additional fees payable:</b>	<b>EUR 375</b>

**Total additional fees payable: EUR 375.**

Using the same example, at the end of the grace period the Office would issue a notification to the proprietor of loss of rights for the remaining three classes of goods or services which were not renewed, for which registration is deemed expired.

## 10 Entries in the Register

Articles [53\(5\)](#), [111\(6\)](#) and Article [111\(3\)\(k\)](#) EUTMR

Article 13(4) CDR

Article 69(3)(m) and Article 69(5) and Article 71 CDIR

Where the request for renewal complies with all the requirements, the renewal will be registered.

The Office will notify the proprietor/holder of the renewal of the EUTM/RCD, of its entry in the Register, and the date from which renewal takes place. Where the renewal applicant is a person other than the registered proprietor/holder or its representative on file, they will also be informed of the renewal.

Where renewal has taken place only for some of the goods and services contained in the registration, the Office will notify the proprietor of the goods and services for which the registration has been renewed and the entry of the renewal in the Register and of the date from which renewal takes effect (see [paragraph 11](#) below). After the expiry of

the grace period, the Office will notify the proprietor of expiry of the registration for the remaining goods and services and of their removal from the Register.

Where only some of the designs contained in a multiple application have been renewed, the Office will notify the holder of the designs for which the registration has been renewed, of the entry of the renewal in the Register and of the date from which renewal takes effect (see [paragraph 11](#) below). After the expiry of the grace period, the Office will notify the holder of expiry of the registration for the remaining designs and of their removal from the Register.

[Article 53\(5\), \(8\)](#) and [Article 99 EUTMR](#)

Article 13(4) CDR

Articles 22(5) and 40(2) CDIR

Where the Office has made a determination pursuant to [Article 53\(8\) EUTMR](#) or Article 22(5) CDIR that the registration has expired, the Office will cancel the mark/design in the Register and notify the proprietor/holder accordingly. The proprietor/holder may apply for a decision on the matter under [Article 99 EUTMR](#) or Article 40(2) CDIR within 2 months.

## 11 Date of Effect of Renewal or Expiry, Conversion

### 11.1 Date of effect of renewal

[Article 53\(6\) and \(8\) EUTMR](#)

[Article 67\(2\) EUTMDR](#)

Article 12 and Article 13(4) CDR

Article 22(6) CDIR

Renewal will take effect from the day following the date on which the existing registration expires.

For example:

- Where the filing date of the EUTM registration is 01/04/2010, the registration will expire on 01/04/2020. Therefore, renewal takes effect from the day following 01/04/2020, namely 02/04/2020. Its new term of registration is 10 years from this date, which will end on 01/04/2030.
- Where the filing date of the RCD is 01/04/2015, the registration will expire on 01/04/2020. Therefore, renewal takes effect from the day following 01/04/2020, namely 02/04/2020. Its new term of registration is five years from this date, which will end on 01/04/2025.

It is immaterial whether any of these days is a Saturday, Sunday or an official holiday. Even in cases where the renewal fee is paid within the grace period, the renewal takes effect from the day following the date on which the existing registration expires.

Where the EUTM or RCD has expired and is removed from the Register, the cancellation will take effect from the day following the date on which the existing registration expired. Using the same two examples listed above, the removal from the Register would take effect on 02/04/2020 (for the EUTM) and 02/04/2020 (for the RCD).

## 11.2 Conversion of lapsed EUTMs

Articles [53\(3\)](#) and [139\(5\)](#) EUTMR

Where the owner wants to convert its lapsed EUTM into a national mark, the request must be filed within 3 months from the day following the last day of the 6-month grace period. The time limit of 3 months for requesting conversion starts automatically without notification (see the Guidelines, [Part E, Register Operations, Section 2, Conversion](#)).

## 12 Renewal of International Marks Designating the EU

[Article 202\(1\)](#) EUTMR

The procedure for renewal of international marks is managed entirely by the International Bureau. The Office will not deal with renewal requests or payment of renewal fees. The International Bureau will send notice for renewal, receive the renewal fees and record the renewal in the International Register. The effective date of the renewal is the same for all designations contained in the international registration, irrespective of the date on which such designations were recorded in the International Register. Where an international registration designating the EU is renewed, the Office will be notified by the International Bureau.

If the international registration is not renewed for the designation of the EU, it can be converted into national marks or into subsequent designations of Member States under the Madrid Protocol. The 3-month time limit for requesting conversion starts on the day following the last day on which renewal may still be effected before WIPO pursuant to Article 7(4) of the Madrid Protocol (see the Guidelines, [Part E, Register Operations, Section 2, Conversion](#)).

## **13 Renewal of International Design Registrations Designating the EU**

Article 106a CDR

Article 22a CDIR

International registrations must be renewed directly at the International Bureau of WIPO in compliance with Article 17 of the Geneva Act. The Office will not deal with renewal requests or payments of renewal fees in respect of international registrations.

The procedure for the renewal of international design registrations is managed entirely by the International Bureau, which sends out the notice for renewal, receives the renewal fees and records the renewal in the International Register. When international registrations designating the EU are renewed, the International Bureau also notifies the Office.

**GUIDELINES FOR EXAMINATION**

**EUROPEAN UNION**  
**INTELLECTUAL PROPERTY OFFICE**  
**(EUIPO)**

***Part E***

***Register operations***

***Section 5***

***Inspection of files***

## Table of Contents

<b>1 General Principles.....</b>	<b>1618</b>
<b>2 The Registers of EUTMs and Community Designs.....</b>	<b>1619</b>
<b>3 Inspection of the Registers.....</b>	<b>1619</b>
<b>3.1 Information contained in the Registers.....</b>	<b>1619</b>
3.1.1 The Register of EUTMs.....	1619
3.1.2 The Register of Community designs.....	1620
<b>4 Inspection of Files.....</b>	<b>1620</b>
<b>4.1 Persons/Entities authorised to request access to the files.....</b>	<b>1620</b>
<b>4.2 Documents that constitute the files.....</b>	<b>1620</b>
4.2.1 The files relating to EUTM applications.....	1621
4.2.2 The files relating to RCD applications.....	1622
4.2.3 The files relating to registered EUTMs.....	1622
4.2.4 The files relating to RCDs.....	1622
4.2.5 The files relating to international registrations designating the European Union.....	1623
<b>5 Parts of the File Excluded from Inspection.....</b>	<b>1623</b>
<b>5.1 Excluded documents.....</b>	<b>1623</b>
5.1.1 Documents relating to exclusion or objection.....	1624
5.1.2 Draft decisions and opinions and internal documents.....	1625
5.1.3 Parts of the file for which the party concerned expressed a special interest in keeping confidential.....	1625
<b>5.2 Access for applicant or proprietor to excluded documents.....</b>	<b>1627</b>
<b>6 Procedures before the Office Relating to Applications for Inspection of Files.....</b>	<b>1628</b>
<b>6.1 Certified or uncertified extracts of the Registers.....</b>	<b>1628</b>
6.1.1 Extracts from the Register of EUTMs.....	1628
6.1.2 Extracts from the Register of Community designs.....	1628
<b>6.2 Certified or uncertified copies of file documents.....</b>	<b>1629</b>
<b>6.3 Online access to the files.....</b>	<b>1629</b>
<b>6.4 Downloadable certified copies.....</b>	<b>1630</b>
<b>6.5 Online applications for inspection of files.....</b>	<b>1631</b>
<b>6.6 Written applications for inspection of files.....</b>	<b>1631</b>

<b>6.7 Languages.....</b>	<b>1631</b>
6.7.1 For EUTM or RCD applications.....	1631
6.7.2 For registered EUTMs or RCDs.....	1632
<b>6.8 Representation and authorisation.....</b>	<b>1632</b>
<b>6.9 Contents of the application for inspection of files.....</b>	<b>1632</b>
<b>6.10 Deficiencies.....</b>	<b>1633</b>
<b>6.11 Fees for inspection and communication of information contained in the files.....</b>	<b>1633</b>
6.11.1 Communication of information contained in a file.....	1633
6.11.2 Inspection of the files.....	1634
6.11.3 Consequences of failure to pay.....	1635
6.11.4 Refund of fees.....	1635
<b>6.12 Requirements concerning the right to obtain inspection of files concerning an unpublished EUTM application, or a deferred RCD filed by a third party.....</b>	<b>1636</b>
6.12.1 Consent.....	1636
6.12.2 Statement that EUTM or RCD rights will be invoked.....	1637
<b>6.13 Grant of inspection of files, means of inspection.....</b>	<b>1637</b>
6.13.1 Communication of information contained in a file.....	1638
6.13.2 Copies of file documents.....	1638
6.13.3 Specific interest concerning the inspection applicant.....	1638
<b>7 Procedures to Give Access to the Files to Courts or Authorities of the Member States.....</b>	<b>1639</b>
<b>7.1 No fees.....</b>	<b>1639</b>
<b>7.2 No restriction as to unpublished applications.....</b>	<b>1640</b>
<b>7.3 Means of inspection.....</b>	<b>1641</b>



# 1 General Principles

[Article 111\(1\) and \(5\)](#), [Article 114](#), [Article 117\(1\) and \(2\)](#) and [Annex 1 A\(30\) EUTMR](#)

Articles [20](#) and [21](#) EUTMIR

Articles 72, 74, and 75 CDR

Article 69(1), Articles 74, 75, 77 and 78 CDIR

The principle established under the European Union trade mark and design system is that:

- the ‘Register of European Union trade marks’ and the ‘Register of Community designs’ contain all particulars relating to European Union trade mark (EUTM) applications and Community design applications and registered EUTMs and registered Community designs (RCD); and
- the ‘files’ contain all correspondence and decisions relating to those trade marks and designs.

Both the Registers and the files of the Office are, in principle, open to inspection by the public. However, before publication of an EUTM application, an RCD or when an RCD is subject to deferred publication, inspection of files is possible only in exceptional cases (see paragraphs [4.2.1](#) and [4.2.2](#) below).

All the information in the Registers is stored in the Office’s databases and, where applicable, published in the EUTM/RCD Bulletin in electronic format.

This section of the Guidelines deals specifically with inspection of files.

Inspection of the files may involve:

- inspection of the Registers;
- obtaining certified or uncertified extracts of the Registers;
- inspection of the content of the file(s);
- the communication of information contained in the files, implying communication of specific information contained in the files without supplying the actual file document(s);
- obtaining certified or uncertified copies of documents contained in the files.

In these Guidelines, the term ‘inspection of the files’ is used to cover all of the abovementioned forms of inspection of files, unless otherwise stated.

The provisions in the CDR and CDIR dealing with the inspection of files of Community designs are almost identical to the equivalent provisions of the EUTM Regulations. Therefore, the following applies *mutatis mutandis* to Community designs. Where the procedure is different, the differences are specified under a separate sub-heading.

## 2 The Registers of EUTMs and Community Designs

### [Article 111\(1\) and \(5\) EUTMR](#)

Article 72 CDR

Article 69 CDIR

The Registers are maintained electronically and consist of entries in the Office's database systems. They are available on the Office website for public inspection, except, in the case of Community designs, to the extent that Article 50(2) CDR provides otherwise. Insofar as some data contained in the Registers are not yet available online, the only means of access is by a request for information or by obtaining certified or uncertified extracts or copies of the file documents from the Registers, which is subject to the payment of a fee.

## 3 Inspection of the Registers

### 3.1 Information contained in the Registers

#### 3.1.1 The Register of EUTMs

### [Article 111\(2\), \(3\) and \(4\) EUTMR](#)

Decision No [EX-21-4](#) of the Executive Director of the Office of 30 March 2021 on the Register of EU trade marks, the Register of Community designs, the database of proceedings before the Office, and on the case-law database, and its [Annex I](#) and [Annex II](#).

The Register of EUTMs contains the information specified in [Article 111\(2\) and \(3\) EUTMR](#) and any other items determined by the Executive Director of the Office pursuant to [Article 111\(4\) EUTMR](#).

### 3.1.2 The Register of Community designs

Article 50 CDR

Articles 69 and 73 CDIR

Decision No [EX-21-4](#) of the Executive Director of the Office of 30 March 2021 on the Register of EU trade marks, the Register of Community designs, the database of proceedings before the Office, and on the case-law database.

The Register of Community designs contains the information specified in Article 69 CDIR and any other items determined by the Executive Director of the Office.

In accordance with Article 73(a) CDIR, where the RCDs are subject to a deferment of publication pursuant to Article 50(1) CDR, access to the Register to persons other than the holder shall be limited to the name of the holder, the name of any representative, the date of filing and registration, the file number of the application and the mention that publication is deferred.

## 4 Inspection of Files

### 4.1 Persons/Entities authorised to request access to the files

The rules and degree of access to the files vary according to who requests inspection.

The Regulations differentiate between the following three categories:

- the applicant/proprietor of the EUTM or RCD;
- third parties;
- courts or authorities of the Member States.

Inspection of the files by courts or authorities of the Member States is covered by the system of administrative cooperation with the Office (see [paragraph 7](#) below).

### 4.2 Documents that constitute the files

The files relating to an EUTM or RCD consist of all correspondence between the applicant/proprietor and the Office and all documents (and their related annexes) established in the course of examination, as well as any correspondence concerning the ensuing EUTM or RCD. The file does not include trade mark search reports provided by national offices.

Documents relating to opposition, cancellation, invalidity and appeal proceedings before the Office or other proceedings, such as recordals (transfer, licence, etc.), also form part of the files.

All original documents submitted become part of the file and, therefore, cannot be returned to the person who submitted them. When submitting documents, simple photocopies are sufficient. They do not need to be authenticated or legalised.

Where the parties make use of the mediation services offered by the Office in accordance with Decision No 2013-3 of the Presidium of the Boards of Appeal of 05/07/2013 on the amicable settlement of disputes ('Decision on Mediation'), or the conciliation services in accordance with Decision No 2014-2 of the Presidium of the Boards of Appeal of 31/01/2014 on the friendly settlement of disputes by the competent Board ('Decision on Conciliation'), all correspondence relating to that mediation or conciliation are excluded from inspection of files.

[Article 115 EUTMR](#)

Article 76 CDIR

Even where an EUTM application is no longer pending, or an EUTM registration or RCD registration ceases to have effect, inspection of the respective files remains possible just as if the application or registration were still pending or effective, as long as the files are kept. An EUTM application or RCD application ceases to be pending when it is rejected, or when the application has been withdrawn or is considered to have been withdrawn, and an EUTM registration or RCD registration ceases to have effect when it expires or is surrendered, declared invalid or revoked. Where the files are kept in electronic format, the electronic files, or back-up copies thereof, will be kept indefinitely. Where, and to the extent that files or part of files are kept in any form other than electronically, the Office will keep the files in any form other than electronic format for at least 5 years from the end of the year in which such an event occurs.

#### 4.2.1 The files relating to EUTM applications

Articles [44](#) and [114](#) EUTMR

[Article 7 EUTMIR](#)

The files relating to EUTM applications are available for inspection once the application has been published by the Office in the EUTM Bulletin. The day of publication is the date of issue shown in the EUTM Bulletin and is reflected under the INID code 442 in the Register. The dissemination of data relating to unpublished EUTM applications by means of online access or otherwise does not constitute publication of the application within the meaning of [Article 44 EUTMR](#) and [Article 7 EUTMIR](#).

Before the publication of the application, inspection of the files is restricted and possible only if one of the following conditions is fulfilled:

- the applicant for inspection is the EUTM applicant; or
- the EUTM applicant has consented to inspection of the file relating to the EUTM application (see [paragraph 6.12.1](#) below); or

- the applicant for inspection can prove that the EUTM applicant has stated that it will invoke the rights under the EUTM, once registered, against the applicant for inspection (see [paragraph 6.12.2](#) below).

[Article 41\(3\)](#) and [Article 115 EUTMR](#)

The applicant always has access to the files relating to its own EUTM application. This comprises the following:

- the EUTM application, even where the Office has refused to attribute a filing date to it or where the application does not fulfil the minimum requirements for the attribution of a filing date, in which case the application will not be dealt with as an EUTM application and, legally speaking, there is no EUTM application;
- the files for as long as they are kept (see [paragraph 4.2](#)), even after the EUTM application has been rejected or withdrawn.

#### 4.2.2 The files relating to RCD applications

Articles 50 and 74 CDR

Article 70 and Article 74(2) CDIR

The files relating to RCD applications, or an RCD still subject to deferment of publication, including those that have been surrendered, are only available for inspection if one of the following conditions is fulfilled:

- the applicant for inspection is the RCD applicant/holder; or
- the applicant for the RCD has consented to inspection of the file relating to the RCD application; or
- the applicant for inspection has established a legitimate interest in the inspection of the RCD application, in particular where the applicant for the RCD has stated that after the design has been registered he/she will invoke the rights under it against the person requesting the inspection.

In the case of an application for multiple RCDs, this inspection restriction will only apply to information relating to the RCDs subject to deferment of publication, or to those that are not eventually registered, either due to rejection by the Office or withdrawal by the applicant.

#### 4.2.3 The files relating to registered EUTMs

The files relating to EUTMs after registration are available for inspection.

#### 4.2.4 The files relating to RCDs

The files relating to RCDs are available for inspection once the registration has been published by the Office in the Community Designs Bulletin. The day of publication is

the date of issue shown in the Community Designs Bulletin and is reflected under the INID code 45 in the Register.

For inspection of the files relating to an RCD that is subject to deferment of publication, please see [paragraph 4.2.2.](#), above.

#### 4.2.5 The files relating to international registrations designating the European Union

Articles [114\(8\)](#), Articles [189](#) and [190](#) EUTMR

Article 106(d) CDR

Article 71 CDIR

International registrations are exclusive rights administered by the International Bureau of the World Intellectual Property Organization (WIPO) in Geneva according to the Madrid Protocol (in the case of trade marks) and the Geneva Act (in the case of designs). WIPO processes the applications and then sends them to the Office for examination in accordance with the conditions specified in the EUTMR and in the CDR. These registrations have the same effect as applying directly for an EUTM or an RCD.

The files kept by the Office relating to international trade mark registrations designating the EU may be inspected on request as from the date of publication referred to in Articles [114\(8\)](#) and [190\(1\)](#) EUTMR. The same rules apply as for the inspection of EUTMs.

The Office provides information on international registrations of designs designating the EU in the form of an electronic link to the searchable database maintained by the International Bureau (<http://www.wipo.int/designdb/hague/en/>). The files kept by the Office may relate to the refusal of the international design pursuant to Article 106e CDR and the invalidation of the international design pursuant to Article 106f CDR. They may be inspected subject to the restrictions pursuant to Article 72 CDIR (see paragraph 5 below) and subject to the same limitations as explained in paragraphs [4.2.2](#) and [4.2.4](#) above.

## 5 Parts of the File Excluded from Inspection

### 5.1 Excluded documents

[Article 114\(4\)](#) and [Article 169](#) EUTMR

Article 72 CDIR

Certain documents contained in the files are excluded from inspection of files, namely:

- documents relating to the exclusion of or objection to Office staff, for example, on the grounds of suspicion of partiality;
- draft decisions and opinions and all other internal documents used for preparing decisions and opinions;
- parts of the file for which the party concerned expressed a special interest in keeping confidential;
- all documents relating to the invitation of the Office to find a friendly settlement, except those that have an immediate impact on the trade mark or design, such as limitations, transfers etc., and have been declared to the Office. (For mediation and conciliation proceedings, see [paragraph 4.2](#) above).

The files relating to requests for entry on the Office's list of professional representatives or designs list, including all decisions taken therein, are not open to public inspection because the files do not relate to EUTM or RCD proceedings as such (see the Guidelines, [Part A, General rules, Section 5, Professional representation, paragraph 2.3.5](#)).

In principle, documents of a personal nature such as **passports or other identification documents**, which are submitted in particular as evidence in relation to requests for transfer, evidence of '**health data**', which is submitted in particular as evidence in relation to *restitutio in integrum* or as supporting evidence for extension requests, and **bank account extracts**, which may, for example, be attached to applications and requests as evidence of fee payment, because of their inherent personal nature, confidentiality vis à vis any third parties is justified, and, in principle, overrides any third-party interest.

#### 5.1.1 Documents relating to exclusion or objection

[Article 114\(4\) EUTMR](#)

Article 72(a) CDIR

This exception relates to documents in which an examiner states that they consider themselves excluded from participating in the case, and documents in which such a person makes observations about an objection by a party to the proceedings on the basis of a ground for exclusion or suspicion of partiality. However, it does not relate to letters in which a party to the proceedings raises, either separately or together with other statements, an objection based on a ground for exclusion or suspicion of partiality, or to any decision on the action to be taken in the cases mentioned above. The decision taken by the competent instance of the Office, without the person who withdraws or has been objected to, will form part of the files.

### 5.1.2 Draft decisions and opinions and internal documents

[Article 114\(4\) EUTMR](#)

Article 72(b) CDIR

This exception relates to documents used for preparing decisions and opinions, such as reports and notes drafted by an examiner that contain considerations or suggestions for dealing with or deciding on a case, or annotations containing specific or general instructions on dealing with certain cases.

Documents that contain a communication, notice or final decision by the Office in relation to a particular case are not included in this exception. Any document to be notified to a party to the proceedings will take the form of either the original document or a copy thereof, certified by or bearing the seal of the Office, or a computer printout bearing that seal. The original communication, notice or decision or copy thereof will remain in the file.

The Notes and the Guidelines of the Office relating to general procedure and treatment of cases, such as these Guidelines, do not form part of the files. The same is true for measures and instructions concerning the allocation of duties.

### 5.1.3 Parts of the file for which the party concerned expressed a special interest in keeping confidential

[Article 114\(4\) EUTMR](#)

Article 72(c) CDIR

#### **Point in time for the request**

Keeping all or part of a document confidential may be requested on its submission or at a later stage, as long as there is no pending request for an inspection of files. During inspection of files proceedings confidentiality may not be requested.

Parts of the file for which the party concerned expressed a special interest in keeping confidential before the application for inspection of files was made are excluded from inspection of files, unless their inspection is justified by an overriding legitimate interest of the party seeking inspection.

#### **Invoking confidentiality and expressing a special interest**

The party concerned must have expressly invoked, and sufficiently justified, a special interest in keeping the document confidential (see 08/11/2018, [R 722/2018-5](#), nume (fig.) / Numederm, § 16). Where any request is submitted on an Office form (paper or e-filing format), the form itself cannot be marked as confidential. However, any attachments thereto may be excluded from inspection of files. This applies to all proceedings as the form includes the minimum information, which is later included in



the publicly available Register, and is, therefore, incompatible with a declaration of confidentiality.

If a special interest in keeping a document confidential is invoked, the Office must check whether that special interest is sufficiently demonstrated. The documents falling into this category must originate from the party concerned (e.g. EUTM/RCD applicant, opponent).

#### Confidentiality invoked and special interest claimed

Where special interest is invoked and elaborated upon, the special interest must be due to the confidential nature of the document or its status as a trade or business secret. This may be the case, for example, where the applicant has submitted underlying documentation as evidence in respect of a request for registration of a transfer or licence.

Where the Office concludes that the requirements for keeping documents confidential are not met because the special interests claimed do not justify maintaining the confidentiality of the document, prior to lifting the confidentiality it will communicate with the person who filed the documents and make a decision. In reply, the applicant may submit evidence in such a way that avoids revealing parts of the document or information that the applicant considers confidential, as long as the parts of the document submitted contain the required information. For example, where contracts or other documents are submitted as evidence for a transfer or licence, certain information may be blacked out before being submitted to the Office, or certain pages may be omitted altogether.

#### Confidentiality invoked with no attempt to claim any special interest

Where a claim for confidentiality has been submitted by the party by use of a standard 'confidential' stamp on the cover page of the submission, or by ticking the 'confidential' tick-box when using the electronic communication platform, but the documents enclosed contain no explanation nor indication of any special interest nor any attempt on behalf of the party to justify the confidential nature or status of the submission, the Office will remove this indication.

This applies to all submissions where the party claims confidentiality 'by default', yet provides no justification in support of its claim. The party can at any time before the receipt of a request for inspection of files, invoke and sufficiently justify a special interest in keeping the document confidential.

In the event that the Office invites the parties to opposition, cancellation or invalidity proceedings to consider a friendly settlement, all corresponding documents referring to those proceedings are considered confidential and, in principle, not open to inspection of files.

Access to documents that the Office has accepted as being confidential and thus, excluded from inspection, may nevertheless be granted to a person who demonstrates an overriding legitimate interest in inspecting the document. The overriding legitimate interest must be that of the person requesting inspection.

If the file contains such documents, the Office will inform the applicant for inspection of files about the existence of such documents within the files. The applicant for inspection of files may then decide whether or not it wants to file a request invoking an overriding legitimate interest. Each request must be analysed on its own merits.

The Office must give the party requesting inspection the opportunity to present its observations.

Before taking a decision, the request, as well as any observations, must be sent to the party concerned, who has a right to be heard.

[Article 67 EUTMR](#)

Article 56 CDR

The Office must make a decision as to whether to grant access to such documents. Such a decision may be appealed by the adversely affected party.

## 5.2 Access for applicant or proprietor to excluded documents

[Article 114\(4\) EUTMR](#)

Article 72 CDIR

Where an applicant or proprietor requests access to their own file, this will mean all documents forming part of the file, excluding only those documents referred to in [Article 114\(4\) EUTMR](#) and Article 72(a) and (b) CDIR.

In *inter partes* proceedings, where the one concerned (the opponent or applicant for revocation or declaration of invalidity) has shown a special interest in keeping its document confidential vis-à-vis third parties, it will be informed that the documents cannot be kept confidential with respect to the other party to the proceedings and it will be invited to either disclose the documents or withdraw them from the proceedings. If it confirms the confidentiality, the documents will not be sent to the other party and will not be taken into account by the Office in the decision.

If, on the other hand, it wants the documents to be taken into account but not available for third parties, the documents can be forwarded by the Office to the other party to the proceedings, but will not be available for inspection by third parties (for opposition proceedings, see the Guidelines, [Part C, Opposition, Section 1, Opposition Proceedings, paragraph 4.4.4](#)).

## **6 Procedures before the Office Relating to Applications for Inspection of Files**

### **6.1 Certified or uncertified extracts of the Registers**

#### **6.1.1 Extracts from the Register of EUTMs**

##### [Article 111\(7\) EUTMR](#)

The Office shall provide certified or uncertified extracts from the Register on request, on payment of a fee. Downloadable (certified) copies are, however, free of charge (see [paragraph 6.4](#) below).

Requests for an extract from the Register of EUTMs may be submitted using the online form which can be found on the Office's website at <https://euipo.europa.eu/ohimportal/en/forms-and-filings>, or any equivalent request.

Any language version of this form may be used, provided that it is completed in one of the languages referred to in [paragraph 6.7](#) below

##### [Article 63 EUTMDR](#)

An application for inspection of files may be submitted as a signed original by electronic means, post or courier (see [paragraph 6.5](#) below).

#### **6.1.2 Extracts from the Register of Community designs**

##### Article 50 CDR

##### Articles 69 and 73 CDIR

Subject to Article 73 CDIR, the Office shall provide certified or uncertified extracts from the Register on request, on payment of a fee.

Where the registration is subject to a deferment of publication, pursuant to Article 50(1) CDR, certified (or uncertified) extracts from the Register shall contain only the name of the holder, the name of any representative, the date of filing and registration, the file number of the application and the mention that publication is deferred, except where the request has been made by the holder or its representative.

Requests for an extract from the Register of Community designs may be submitted using the online form, which can be found on the Office's website at <https://euipo.europa.eu/ohimportal/en/forms-and-filings>, or any equivalent request.

Any language version of this form may be used, provided that it is completed in one of the languages referred to in [paragraph 6.7](#) below.

Articles 65, 66 and 67 CDIR
-----------------------------

An application for inspection of files may be submitted as a signed original by electronic means, post or courier (see [paragraph 6.5](#) below).

## 6.2 Certified or uncertified copies of file documents

The Office shall provide certified or uncertified copies of documents constituting the files (see [paragraph 4.2](#) above) on request, on payment of a fee. Downloadable (certified) copies are, however, free of charge (see [paragraph 6.4](#) below).

Requests for certified or uncertified copies of documents may be submitted using the online form, which can be found on the Office's website at <https://euipo.europa.eu/ohimportal/en/forms-and-filings>, or any equivalent request.

Any language version of this form may be used, provided that it is completed in one of the languages referred to in [paragraph 6.7](#) below.

Certified and uncertified copies of the EUTM and RCD applications, registration certificates, extracts of the Register and copies of the documents in the file (available only for EUTMs), may also be requested as an alternative to the downloadable copies available free of charge (see [paragraph 6.4](#) below).

Certified copies of the EUTM application or the RCD registration certificate will only be available when a filing date has been accorded (for EUTM filing date requirements, see the Guidelines, [Part B, Examination, Section 2, Formalities](#); for RCD filing date requirements, see the Guidelines on Examination of Applications for Registered Community Designs).

In the case of an application for multiple designs, certified copies of the application will only be available for those designs that have been accorded a filing date.

Where the EUTM application or RCD registration has not yet been published, a request for certified or uncertified copies of the file documents will be subject to the restrictions listed in paragraphs [4.2.1](#) to [4.2.4](#) above.

It should be borne in mind that the certified copy of the application or registration only reflects the data on the date of application or registration. The trade mark or design may have been the subject of a transfer, surrender, partial surrender or other act affecting its scope of protection, which will not be reflected in the certified copy of the EUTM application form or EUTM/RCD registration certificate. Up-to-date information is available from the electronic database or by requesting a certified extract of the Register (see [paragraph 6.1](#) above).

## 6.3 Online access to the files

The contents of the files are available in the 'Correspondence' section of the file in the Office's online tool on the Office's website.

Providing the EUTM application or the RCD registration (not subject to a deferment) has been published, registered users of the website can consult these files free of charge.

## 6.4 Downloadable certified copies

Decision No [EX-20-9](#) of the Executive Director of the Office of 3\_November 2020 on communication by electronic means, and its [Annex I](#).

Decision No [EX-21-4](#) of the Executive Director of the Office of 30\_March 2021 on the Register of EU trade marks, the Register of Community designs, the database of proceedings before the Office, and on the case-law database, Article\_5, and its [Annex I](#) and [Annex II](#).

### [Article 51\(2\) EUTMR](#)

Certified and uncertified copies of the EUTM and RCD applications, registration certificates, extracts of the Register and copies of the documents in the file (available only for EUTMs) can be automatically generated and downloaded via a direct link from the Office's website using the Office's online tool, from within the Inspection of Files e-filing form and from within the files for a selected EUTM or RCD.

The copy of the document will be made available in PDF format, and will be composed of a cover page in the five Office languages, introducing the certified document and followed by the certified document itself. The document contains a unique identification code. Each page of the document should bear a header and footer containing important elements in order to guarantee the authenticity of the certified copy: a unique identification code, a 'copy' stamp, the signature of the Office staff member responsible for issuing certified copies, the date of the certified copy, the EUTM/RCD number and page number. The date indicated is the date when the certified copy was automatically generated.

The automatically generated certified copies have the same value as certified copies sent on paper on request, and can be used either in electronic format or printed.

When an authority receives a certified copy, it can verify the original document online using the unique identification code given in the certified copy. A link 'Verify certified copies' is available under the 'Databases' section of the Office's website. Clicking on the link will bring up a screen with a box in which the unique identification code can be entered in order to retrieve and display the original document from the Office's online systems.

It should be borne in mind that the certified copy only reflects the data on the date of application/registration. The trade mark or design may have been the subject of a transfer, surrender, partial surrender or other act affecting its scope of protection, which will not be reflected in the certified copy of the EUTM application form or EUTM/RCD

registration certificate. Up-to-date information is available from the electronic database or by requesting a certified extract of the Register or database.

## 6.5 Online applications for inspection of files

Users may access the application form online through their user account, where they will be invited to log in and complete the application for inspection of files requesting certified or uncertified copies of specific documents.

## 6.6 Written applications for inspection of files

[Article 63 EUTMDR](#)

Article 65 CDIR

Applications for inspection may be submitted using the online form, which can be found on the Office's website at <https://euipo.europa.eu/ohimportal/en/forms-and-filings>, or any equivalent request.

Any language version of this form may be used, provided that it is completed in one of the languages referred to in [paragraph 6.7](#) below.

[Article 63 EUTMDR](#)

Article 67 CDIR

An application for inspection of files may be submitted as a signed original form by electronic means (see [paragraph 6.5](#) above), post or courier.

## 6.7 Languages

Applications for inspection of files must be filed in one of the languages indicated below.

### 6.7.1 For EUTM or RCD applications

[Article 146\(6\) and \(9\) EUTMR](#)

[Article 25 EUTMIR](#)

Articles 80, 81, 83 and 84 CDIR

Where the application for an inspection of files relates to a EUTM application or RCD application, whether already published or not, it must be filed in the language in which the EUTM application or RCD application was filed (the 'first' language) or in the

second language indicated by the EUTM applicant or RCD applicant in their application (the 'second' language).

Where the application for inspection is filed in a language other than indicated above, the applicant for inspection must, of its own motion, submit a translation into one of the languages indicated above within 1 month. If such a translation is not submitted within the deadline, the application for inspection of files will be considered not to have been filed.

This does not apply where the applicant for inspection could not have been aware of the languages of the EUTM application or RCD application. This can be the case only where such information is not available in the online Register and the application can immediately be dealt with. In this case, the application for inspection may be filed in any of the five languages of the Office.

#### 6.7.2 For registered EUTMs or RCDs

[Article 146\(6\) and \(9\) EUTMR](#)

[Article 25 EUTMIR](#)

Article 80(b), Articles 81, 83 and 84 CDIR

Where the application for inspection of files relates to a registered EUTM or RCD, it must be filed in one of the five languages of the Office.

The language in which the application for inspection was filed will become the language of the inspection proceedings.

Where the application for inspection of files is made in a language other than indicated above, the party requesting inspection must, on its own motion, submit a translation into one of the languages indicated above within one month, or the application for inspection of files will be considered not to have been filed.

## 6.8 Representation and authorisation

Representation is not mandatory for filing an application for inspection of files.

Where a representative is appointed, the general rules for representation and authorisation apply. See the Guidelines, [Part A, General Rules, Section 5, Professional Representation](#).

## 6.9 Contents of the application for inspection of files

The application for inspection of files mentioned in paragraphs [6.5](#) and [6.6](#) above must contain the following.

- An indication of the file number or registration number for which inspection is applied.
- The name and address of the applicant for inspection of files.
- If appropriate, an indication of the document or information for which inspection is applied (applications may be made to inspect the whole file or specific documents only). In the case of an application to inspect a specific document, the nature of the document (e.g. 'application', 'notice of opposition') must be stated. Where communication of information from the file is applied for, the type of information needed must be specified. Where the application for inspection relates to an EUTM application that has not yet been published, the application for an RCD that has not yet been published or an RCD that is subject to deferment of publication in accordance with Article 50 CDR or which, being subject to such deferment, has been surrendered before or on the expiry of that period, and inspection of the files is applied for by a third party, an indication and evidence to the effect that the third party concerned has a right to inspect the file.
- Where copies are requested, an indication of the number of copies requested, whether or not they should be certified and, if the documents are to be presented in a third country requiring an authentication of the signature (legalisation), an indication of the countries for which authentication is needed.
- The applicant's signature in accordance with [Article 63\(1\) EUTMDR](#) and Article 65 CDIR.

## 6.10 Deficiencies

Where an application for inspection of the files fails to comply with the requirements concerning the contents of applications, the applicant for inspection will be invited to remedy the deficiencies. If deficiencies are not remedied within the established time limit, the application for inspection will be refused.

## 6.11 Fees for inspection and communication of information contained in the files

All fees are due on the date of receipt of the application for inspection (see paragraphs [6.5](#) and [6.6](#) above).

### 6.11.1 Communication of information contained in a file

[Article 114\(9\)](#) and [Annex I A\(32\) EUTMR](#)

Article 75 CDIR

Article 2 CDFR in conjunction with Annex (23) CDFR

Communication of information in a file is subject to payment of a fee of EUR 10.



## 6.11.2 Inspection of the files

[Article 114\(6\)](#) and [Annex I A\(30\) EUTMR](#)

Article 74(1) CDIR

Article 2 and Annex (21) CDFR

A request for inspection of the files on the Office premises is subject to payment of a fee of EUR 30.

[Article 114\(7\)](#) and [Annex I A\(31\)\(a\) EUTMR](#)

Article 74(4) CDIR

Article 2 and Annex (22) CDFR

Where inspection of a file is obtained through the issuing of **uncertified** copies of file documents, those copies are subject to payment of a fee of EUR 10 plus EUR 1 for every page exceeding ten.

[Article 51\(2\) EUTMR](#)

Articles [111\(7\)](#), [114\(7\)](#) and [Annex I A\(29\)\(a\) EUTMR](#)

Articles 17(2), 69(6) and 74(5) CDIR

Article 2 and Annex 20 CDFR

An **uncertified** copy of an EUTM application or RCD application, an **uncertified** copy of the certificate of registration, an **uncertified** extract from the Register or an **uncertified** extract of the EUTM application or RCD application from the database is subject to payment of a fee of EUR 10 per copy or extract.

However, registered users of the website can obtain electronic **uncertified** copies of EUTM or RCD applications or registration certificates free of charge through the website.

[Article 114\(7\)](#) and [Annex I A\(31\)\(b\) EUTMR](#)

Article 74(4) CDIR

Article 2 and Annex (22) CDFR

Where inspection of a file is obtained through the issuing of **certified** copies of file documents, those copies are subject to payment of a fee of EUR 30 plus EUR 1 for every page exceeding ten.

[Article 51\(2\) EUTMR](#)

Articles [111\(7\)](#), [114\(7\)](#) and [Annex I A\(29\)\(b\)](#) EUTMR

Articles 17(2), 69(6) and 74(5) CDIR

Article 2 and Annex (20) CDFR

A **certified** copy of an EUTM application or RCD application, a **certified** copy of the certificate of registration, a **certified** extract from the Register or a **certified** extract of the EUTM application or RCD application from the database is subject to payment of a fee of EUR 30 per copy or extract.

However, registered users of the website can obtain electronic **certified** copies of EUTM or RCD applications or registration certificates free of charge through the website.

### 6.11.3 Consequences of failure to pay

[Article 114\(6\) EUTMR](#)

Article 74(1) CDIR

An application for inspection of files will be considered not to have been filed until the fee has been paid. The fees apply not only where the application for inspection has been filed by a third party, but also where it has been filed by the EUTM or RCD applicant or proprietor. The Office will not process the inspection application until the fee has been paid.

However, if the fee is not paid or is not paid in full, the Office will notify the applicant for inspection:

- if no payment is received by the Office for a certified or uncertified copy of an EUTM application or RCD application, a certificate of registration or an extract from the Register or from the database;
- if no payment is received by the Office for inspection of the files obtained through the issuing of certified or uncertified copies of file documents;
- if no payment is received by the Office for the communication of information contained in a file.

The Office will issue a letter indicating the amount of fees to be paid. If the exact amount of the fee is not known to the applicant for inspection because it depends on the number of pages, the Office will either include that information in the standard letter or inform the applicant for inspection by other appropriate means.

### 6.11.4 Refund of fees

Where an application for inspection of the files is rejected, the corresponding fee is not refunded. However, where, after the payment of the fee, the Office finds that not all the

certified or uncertified copies requested may be issued (e.g. if the request concerns confidential documents and the applicant has not proven an overriding legitimate interest), any fees paid in excess of the amount actually due will be refunded.

## **6.12 Requirements concerning the right to obtain inspection of files concerning an unpublished EUTM application, or a deferred RCD filed by a third party**

### [Article 114\(1\) and \(2\) EUTMR](#)

Article 74 CDR

Article 74(2) CDIR

Where an application for inspection of files for an EUTM application that has not yet been published, or for files relating to an RCD subject to deferment of publication in accordance with Article 50 CDR, or for those which, subject to such deferment, have been surrendered before or on the expiry of that period, (see paragraphs [4.2.1](#) and [4.2.2](#) above) is filed by a third party (i.e. by a person other than the EUTM or RCD applicant or its representative), different situations may arise.

If the application by a third party is based on the grounds specified in Article 114(1) and (2) EUTMR (see paragraph [4.2.1](#) above), or in Article 74(2) CDR or in Article 74(2) CDIR (see paragraph [4.2.2](#) above), it must contain an indication and evidence to the effect that the EUTM applicant or RCD applicant or holder has consented to the inspection, or has stated that it will invoke the rights under the RCD, once registered, against the applicant for inspection.

### **6.12.1 Consent**

The consent of the EUTM applicant or RCD applicant or holder must be in the form of a written statement in which it consents to the inspection of the particular file(s). Consent may be limited to inspection of certain parts of the file, such as the application, in which case the application for inspection of files may not exceed the scope of the consent.

Where the applicant for inspection of files does not submit a written statement from the EUTM applicant, RCD applicant or holder consenting to the inspection of the files, the applicant for inspection will be notified and given 2 months from the date of notification to remedy the deficiency.

If, after expiry of the time limit, no consent has been submitted, the Office will reject the application for inspection of files. The applicant for inspection will be informed of the decision to reject the application for inspection.

The decision may be appealed by the applicant for inspection (Articles [67](#) and [68](#) EUTMR and Article 56 CDR).

## 6.12.2 Statement that EUTM or RCD rights will be invoked

### [Article 114\(2\) EUTMR](#)

Article 74(2) CDR

Article 74(2) CDIR

Where the application relies on the allegation that the EUTM or RCD proprietor will invoke the rights under the EUTM or RCD, once registered, it is up to the applicant for inspection to prove this allegation. The proof to be submitted must take the form of documents, such as, statements by the EUTM applicant or RCD applicant or holder for the EUTM application, RCD application or registered and deferred RCD in question, business correspondence, etc. Filing an opposition based on an EUTM application against a national mark constitutes a statement that the EUTM will be invoked. Mere assumptions on the part of the applicant for inspection of the file will not constitute sufficient proof.

The Office will first examine whether the proof is sufficient.

If so, the Office will send the application for inspection of files and the supporting documents to the EUTM applicant or RCD applicant or holder and invite it to comment within two months. If the EUTM applicant or RCD applicant or holder consents to an inspection of the files, it will be granted. If the EUTM applicant or RCD applicant or holder submits comments contesting inspection of the files, the Office will send the comments to the applicant for inspection. Any further statement by the applicant for inspection will be sent to the EUTM applicant or RCD applicant or holder and vice versa. The Office will take into account all submissions made on time by the parties and decide accordingly. The Office's decision will be notified to both the applicant for inspection of the files and the EUTM applicant or RCD applicant or holder. It may be appealed by the adversely affected party (Articles [67](#) and [68](#) EUTMR and Article 56 CDR).

## 6.13 Grant of inspection of files, means of inspection

When inspection is granted, the Office will send the requested copies of file documents, or requested information, as appropriate, to the applicant for inspection or invite it to inspect the files at the Office's premises. The Office will not forward the requested documents to any third parties.

### 6.13.1 Communication of information contained in a file

[Article 114\(9\) EUTMR](#)

Article 75 CDIR

The Office may, on request, communicate information contained in any file relating to EUTM or RCD applications or registrations.

Information contained in the files will be provided without an application for inspection, inter alia, where the party concerned wishes to know whether a given EUTM application has been filed by a given applicant, the date of such application, or whether the list of goods and services has been amended in the period between the filing of the application and its publication.

Having obtained this information, the party concerned may then decide whether or not to request copies of the relevant documents, or to apply for inspection of the file.

Where the party concerned wishes to know, inter alia, which arguments an opponent has brought forward in opposition proceedings, which seniority documents have been filed, or the exact wording of the list of goods and services as filed, such information will not be provided. Instead the Office will advise the party to apply for inspection of the file.

In such cases, the quantity and complexity of the information to be supplied would exceed reasonable limits and create an undue administrative burden.

### 6.13.2 Copies of file documents

Where inspection of the files is granted in the form of the provision of certified or uncertified copies of file documents, the party will be sent the requested documents.

Where inspection of files is granted on the Office premises, the applicant will be given an appointment to inspect the files.

### 6.13.3 Specific interest concerning the inspection applicant

Where a party shows a specific interest in knowing whether its file has been inspected and by whom, there should be a compromise between the general interest of the public to be able to inspect files of proceedings before the Office with a minimum of formalities and the parties' specific interest to know who has inspected the file in exceptional, duly justified circumstances.

Considering that online inspection requests are not communicated as a matter of course to the party whose file has been inspected, that party must put forward a reasoned and substantiated request showing that there are legitimate reasons for being informed if its file has been inspected, and by whom. The Office will not automatically grant such a request. Instead, on a case-by-case basis, it will balance these reasons against the explanations provided by the person who made the

inspection within a period set by the Office to that effect, before any such request is granted.

## **7 Procedures to Give Access to the Files to Courts or Authorities of the Member States**

[Article 117\(1\) EUTMR](#)

Article 75 CDR

Articles [20](#) and [21](#) EUTMIR

Articles 77 and 78 CDIR

For the purposes of administrative cooperation, the Office will, on request, assist the courts or authorities of the Member States by communicating information or opening files for inspection.

For the purposes of administrative cooperation, the Office will also, on request, communicate relevant information about the filing of EUTM or RCD applications and proceedings relating to such applications, and the marks or designs registered as a result thereof, to the central industrial property offices of the Member States.

### **7.1 No fees**

[Article 20\(3\)](#) and [Article 21\(1\) and \(3\) EUTMIR](#)

Article 77(3) and Article 78(1) and (2) CDIR

Inspection of files and communication of information from the files requested by the courts or authorities of the Member States are not subject to the payment of fees.

[Article 21\(3\) EUTMIR](#)

Article 78(2) CDIR

Courts or public prosecutors' offices of a Member State may open to inspection by third parties files, or copies thereof, that have been transmitted to them by the Office. The Office will not charge any fee for such inspection.

## 7.2 No restriction as to unpublished applications

Articles [114\(4\)](#) and [117\(1\)](#) EUTMR

[Article 20\(1\)](#) EUTMIR

Article 75 CDR

Article 72 and Article 77(1) CDIR

Inspection of files and communication of information from the files requested by the courts or authorities of the Member States is not subject to the restrictions contained in [Article 114 EUTMR](#) and Article 74 CDR. Consequently, these bodies may be granted access to files relating to unpublished EUTM applications (see paragraph [4.2.1](#) above) and RCDs subject to deferment of publication (see paragraph [4.2.2](#) above), as well as to parts of the files for which the party concerned has expressed a special interest in keeping confidential. However, documents relating to exclusion and objection, as well as the documents referred to in [Article 114\(4\) EUTMR](#) and Article 72(b) CDIR, will not be made available to these bodies.

[Article 114\(4\)](#) EUTMR

[Article 21\(3\)](#) EUTMIR

Article 74 CDR

Article 72 and Article 78(2) CDIR

Courts or public prosecutors' offices of the Member States may open to inspection by third parties files or copies that have been transmitted to them by the Office. Such subsequent inspection shall be subject to the restrictions contained in [Article 114\(4\) EUTMR](#) or Article 74 CDR, as if the inspection had been requested by a third party.

[Article 21\(2\)](#) EUTMIR

Article 78(4) CDIR

When transmitting files or copies thereof to the courts or public prosecutors' offices of the Member States, the Office will indicate the restrictions imposed on inspection of files relating, on the one hand to EUTM applications or registrations pursuant to [Article 114 EUTMR](#), and on the other hand to RCD applications or RCD registrations pursuant to Article 74 CDR and Article 72 CDIR.

### **7.3 Means of inspection**

[Article 21\(1\) EUTMIR](#)

Article 78(1) CDIR

Inspection of the files relating to EUTM/RCD applications or registrations by courts or authorities of the Member States may be granted by providing copies of the original documents. As the files contain no original documents as such, the Office will provide printouts from the electronic system.



**GUIDELINES FOR EXAMINATION**  
**EUROPEAN UNION**  
**INTELLECTUAL PROPERTY OFFICE**  
**(EUIPO)**

***Part E***

***Register operations***

***Section 6***

***Other entries in the register***

## Table of Contents

<b>Chapter 1 Counterclaims.....</b>	<b>1644</b>
-------------------------------------	-------------

**GUIDELINES FOR EXAMINATION**

**EUROPEAN UNION**  
**INTELLECTUAL PROPERTY OFFICE**  
**(EUIPO)**

***Part E***

***Register operations***

***Section 6***

***Other entries in the register***

***Chapter 1***

***Counterclaims***

## Table of Contents

<b>1 Introduction.....</b>	<b>1646</b>
<b>2 Application to Register the Filing of a Counterclaim Before an EUTM or a CD Court.....</b>	<b>1646</b>
<b>3 Application to Register a Judgment on a Counterclaim Before an EUTM or a CD Court.....</b>	<b>1647</b>

## 1 Introduction

Counterclaims, as provided for in [Article 128 EUTMR](#) or Article 84 CDR, are defence claims made by a defendant that is being sued for the infringement of an EUTM or Registered Community Design (RCD). By way of such a counterclaim, the defendant asks the European Union trade mark court (EUTM court) or Community design court (CD court) to declare the revocation or invalidity of the EUTM or the invalidity of the RCD that it is alleged to have infringed.

The purpose of recording the filing and the final judgment of the counterclaim in the Office Register lies in the general interest of making all the relevant information on counterclaims concerning EUTMs and RCDs, in particular the final judgments thereof, publicly available. In this way, the Office can implement these final judgments, in particular those that declare the total or partial revocation or invalidity of an EUTM, as well as those that declare the total invalidity of an RCD.

By entering such counterclaims and their final judgments in the Register, the Office strives to comply with the principles of conformity to truth, public faith and the legal certainty of a public register.

## 2 Application to Register the Filing of a Counterclaim Before an EUTM or a CD Court

[Article 111\(3\)\(n\)](#) and [Article 128\(4\) EUTMR](#)

Article 86(2) CDR

Article 69(3)(p) CDIR

Communications [No 9/05](#) and [No 10/05](#) of the President of the Office of 28/11/2005

According to [Article 128\(4\) EUTMR](#) and Article 86(2) CDR, the EUTM or CD court before which a counterclaim for revocation of an EUTM or for a declaration of invalidity of an EUTM or RCD has been filed must inform the Office of the date on which the counterclaim was filed.

The Regulations provide that the EUTM court with which a counterclaim for revocation or for a declaration of invalidity of an EUTM has been filed must not proceed with the examination of the counterclaim until either the interested party or the court has informed the Office of the date on which the counterclaim was filed.

Communications [No 9/05](#) and [No 10/05](#) of the President of the Office of 28/11/2005 concern the designation of EUTM and CD courts in the Member States pursuant to [Article 123 EUTMR](#).

The Office also allows any party to the counterclaim proceedings to request the entry of a counterclaim in the Register, if not yet communicated by the EUTM or CD court.

The applicant should:

- indicate the date on which the counterclaim was filed;
- quote the number of the EUTM or RCD concerned;
- state whether the application is for revocation or for a declaration of invalidity;
- submit evidence that the counterclaim has been raised before the EUTM or CD court with authority to rule on the counterclaim, including, where possible, the case or reference number from the court.

If the above is not submitted, or if the information submitted by the applicant requires clarification, the Office will issue a deficiency letter. If the deficiencies are not remedied, the Office will reject the application for registration of the counterclaim. The party concerned may file an appeal against this decision.

The Office will notify the EUTM or RCD proprietor and the EUTM or CD court that the counterclaim has been entered in the Register. If the request was made by the other party to the counterclaim proceedings, the Office will also inform this party.

If an application for revocation or for a declaration of invalidity of an EUTM had already been filed with the Office before the counterclaim was filed, the Office will inform the courts before which a counterclaim is pending in respect of the same mark. The courts will stay the proceedings in accordance with [Article 132\(1\) EUTMR](#) until the decision on the application is final or the application is withdrawn.

### **3 Application to Register a Judgment on a Counterclaim Before an EUTM or a CD Court**

[Article 111\(3\)\(o\)](#) and [Article 128\(6\) EUTMR](#)

Article 86(4) CDR

Article 69(3)(q) CDIR

Where an EUTM or a CD court has delivered a judgment that has become final on a counterclaim for revocation of an EUTM or for a declaration of invalidity of an EUTM or RCD, a copy of the judgment must be sent to the Office.

The Office also allows any party to the counterclaim proceedings to request the entry of a judgment on the counterclaim action in the Register, if not yet communicated by the EUTM or CD court.

The applicant should:

- submit a copy of the judgment, together with confirmation from the EUTM or CD court that the judgment has become final;
- indicate the date on which the judgment was issued;
- quote the number of the EUTM or RCD concerned;
- state whether the request is for revocation or for a declaration of invalidity;

- in the event of partial cancellation or invalidity, indicate the list of goods and services affected by the judgment, if relevant.

In order to enter the counterclaim in the Register, the Office needs confirmation that the judgment **is final** (*passée en force de chose jugée/rechtskräftig/adquirido fuerza de cosa juzgada*, etc.). If the Office requires clarification, it may request this in writing.

The Office must mention the judgment in the Register and take the necessary measures to comply with its operative part.

Where the final judgment partially cancels an EUTM, the Office will alter the list of goods and services according to the EUTM court judgment and, where necessary, send the amended list of goods and services for translation.

The Office will notify the EUTM or RCD proprietor and the EUTM or CD court that the judgment has been entered in the Register. If the request was made by the other party to the counterclaim proceedings, the Office will also inform this party.

---

**GUIDELINES FOR EXAMINATION OF  
EUROPEAN UNION TRADE MARKS**

**EUROPEAN UNION  
INTELLECTUAL PROPERTY OFFICE  
(EUIPO)**

***Part M***

***International marks***



---

## Table of Contents

<b>1 Introduction.....</b>	<b>1651</b>
<b>2 The EUIPO as Office of Origin.....</b>	<b>1651</b>
<b>3 The EUIPO as Designated Office.....</b>	<b>1664</b>
<b>4 Conversion, Transformation, Replacement.....</b>	<b>1682</b>
<b>5 Division.....</b>	<b>1690</b>

# 1 Introduction

The European Union acceded to the Protocol Relating to the Madrid Agreement Concerning the International Registration of Marks on 01/07/2004.

This part of the Guidelines focuses specifically on the examination of international marks. For further details on general aspects of procedure, please also consult the other relevant parts of the Guidelines (examination, opposition, cancellation, etc.).

The purpose of this part of the Guidelines is to explain how, in practice, the link between the European Union trade mark (EUTM) and the Protocol Relating to the Madrid Agreement Concerning the International Registration of Marks (Madrid Protocol or MP) affects procedures and standards of examination and opposition at the EUIPO. Paragraph 2 deals with the EUIPO's tasks as an office of origin, that is, with 'outgoing' international applications. Paragraph 3 deals with its tasks as a designated office, that is, with 'incoming' international registrations designating the EU (IRs). Paragraph 4 deals with conversion, transformation and replacement.

The Guidelines are not intended to, and cannot, add to or subtract from the substance of Chapter XIII EUTMR. The EUIPO is also bound by the provisions of the Madrid Protocol and the Regulations under the Protocol relating to the Madrid Agreement. Reference may also be made to the [Guide to the Madrid System International Registration of Marks under the Madrid Protocol](#) published by WIPO, as these Guidelines are not intended to repeat the information stated there.

## 2 The EUIPO as Office of Origin

The tasks of the EUIPO as an office of origin comprise:

- examining and forwarding international applications;
- examining and forwarding subsequent designations;
- handling notices of irregularity issued by WIPO;
- notifying WIPO of certain facts affecting the basic mark during the 5-year dependency period;
- forwarding certain requests for changes in the International Register.

## 2.1 Examination and forwarding of international applications

[Article 183](#) and [Article 184\(1\) EUTMR](#)

[Article 28 EUTMIR](#)

International applications filed with the EUIPO are subject to:

- payment of the handling fee;
- the existence of (a) basic EUTM registration(s) or application(s) ('basic mark(s)') for an identical mark;
- proper completion of either the [e-filing form](#) or the paper form (MM2 or EM2);
- an entitlement to file the international application through the EUIPO.

Payment can be made using any of the means of payment accepted by the EUIPO (see the Guidelines, [Part A, General Rules, Section 3, Payment of Fees, Costs and Charges, paragraph 2](#)).

### 2.1.1 Identification of international applications

An international application will be identified in the EUIPO database by the basic EUTM/EUTM application number followed by the suffix **\_01** (e.g. 012345678**\_01**) if it relates to a first international application. Further applications based on the same basic EUTM/EUTM application will be identified by **\_02**, **\_03**, etc. International applications based on more than one EUTM/EUTM application will be identified by the number of the EUTM/EUTM application indicated first in the application.

When an international application is submitted, the Office will issue a receipt quoting the file number.

### 2.1.2 Fees

#### 2.1.2.1 Handling fee

[Article 184\(4\) and \(8\)](#), and [Article 188 EUTMR](#)

[Annex I A\(34\) EUTMR](#)

An international application is only considered to have been filed if the handling fee of EUR 300 has been paid.

Payment of the handling fee must be made to the EUIPO by one of the accepted means of payment (see the Guidelines, [Part A, General Rules, Section 3, Payment of Fees, Costs and Charges, paragraph 2](#)).

Where the applicant chooses to base the international application on an EUTM application once it has been registered, the application for the IR is considered to have been received on the date of registration of the EUTM. In this case, the handling fee will be due on the date of registration of the EUTM.

When the application is not submitted by e-filing, the means of payment used may be communicated to the EUIPO by ticking the appropriate boxes on the EM2 form or by giving this information in the letter accompanying the MM2 form.

If, when examining the international application, the examiner finds that the handling fee has not been paid, the examiner will inform the applicant and ask it to pay the fee within 2 months. If payment is made within the 2-month time limit set by the EUIPO, the date of receipt that the EUIPO will communicate to WIPO will be the date on which the payment reaches the EUIPO. If payment is still not made within the 2-month time limit set by the EUIPO, the EUIPO will inform the applicant that it considers the international application not to have been filed and will close the file.

### 2.1.2.2 International fees

All international fees must be paid directly to WIPO. None of the fees payable directly to WIPO will be collected by the EUIPO. Any such fees paid by error to the EUIPO will be reimbursed to the sender.

If the applicant uses the e-filing tool, it will have the possibility to indicate directly in the application the amount of the international fees and how they will be paid. If the applicant uses the paper EM2 form, the Fee Calculation Sheet (Annex to WIPO form MM2) must be submitted in the language in which the international application is to be transmitted to WIPO. Alternatively, the applicant can attach a copy of the payment to WIPO. However, the EUIPO will not examine whether the Fee Calculation Sheet is attached, whether it is correctly filled in, or whether the amount of the international fees has been correctly calculated. Any questions regarding the amount of the international fees and related means of payment should be addressed to WIPO. A fee calculator is available on WIPO's website.

### 2.1.3 Forms

[Article 184\(1\) to \(3\)](#) and [Article 184\(5\)\(a\) EUTMR](#)

[Article 28 EUTMIR](#)

[Article 65\(2\)\(b\) EUTMDR](#)

The international application must be filed in one of the official languages of the European Union, preferably using the e-filing tool provided by the Office, as it gives guidance to the applicant and, therefore, will potentially reduce the number of deficiencies, and speed up examination.

When the international application is filed using the e-filing tool, it is populated with the data of the basic EUTM registration(s) or application(s) in order to limit as much as possible the manual key-in of data.

The Office also provides paper EM2 forms (the Office adaptation of WIPO's MM2 form) in all official languages. Applicants may not use any other forms, or change the contents or layout of the forms.

If the application is filed in a language that is not one of the MP languages (Spanish, English and French), the applicant must indicate in which of these three languages the application is to be forwarded to WIPO. In such a case, the applicant will be requested to choose whether it authorises the Office to provide a translation, or whether it wishes to provide its own translation of the goods and services, and of any other textual element forming part of the international application, into the language chosen (Spanish, English or French) for forwarding the application to the International Bureau.

If a representative before the International Bureau has been appointed, all communications from the International Bureau will be sent only to that representative.

An email address is compulsory for both the applicant and the representative. All correspondence from the International Bureau will be sent electronically only and no paper correspondence will be issued.

All applicable items in the form must be completed following the indications provided on the form itself and in the 'Guide to the International Registration of Marks' published by WIPO.

#### 2.1.3.1 Entitlement to file

[Article 184\(5\)\(f\) EUTMR](#)

Article 2(1)(ii) MP

The indication regarding the applicant's entitlement to file an international application is compulsory. An applicant is entitled to file with the EUIPO as office of origin if it is a national of, or has a domicile or a real and effective industrial or commercial establishment in, an EU Member State. The applicant may choose on which criterion/criteria to base its right to file. For example, a Danish national domiciled in Germany can choose to base entitlement to file either on nationality or domicile. A French national domiciled in Switzerland is entitled to file only based on nationality (however, in this case, a representative before the EUIPO must be appointed). A Swiss company with no domicile or real and effective industrial or commercial establishment in an EU Member State is not entitled to file an international application through the EUIPO.

Where there are multiple applicants, each must fulfil at least one of the entitlement criteria.

The expression 'real and effective industrial or commercial establishment in an EU Member State' is to be interpreted in the same way as in other instances, such as in the context of professional representation (see the Guidelines, [Part A, General Rules](#),

[Section 5, Parties to the Proceedings and Professional Representation, paragraph 4.4.2 Indirect employment](#)).

A real and effective industrial or commercial establishment in the EU is a branch, agency or any other kind of commercial establishment (including subsidiaries) in the EU that can be considered an extension of the non-EU legal person.

The concept of ‘branch, agency or other establishment’ implies a place of business that has the appearance of permanency, such as the extension of a parent body, has a management system and is materially equipped to negotiate business with third parties so that the latter, although knowing that there will if necessary be a legal link with the parent body, the office of which is abroad, do not have to deal directly with said parent body but may transact business at the place of business constituting the extension (see definition in 22/11/1978, [C-33/78](#), Somafer, EU:C:1978:205, § 12; 22/09/2016, [T-512/15](#), SUN CALI (fig.), EU:T:2016:527, § 30).

All the arguments and evidence the applicant deems necessary to support its claim of entitlement, including any evidence to prove the existence and nature of the link between the different entities, must be filed together with the request. If this evidence is not submitted, the Office will issue a deficiency notice.

### 2.1.3.2 Basic mark

[Article 184\(5\)\(b\) to \(e\) EUTMR](#)

Rule 9(4)(a)(v), (vii) and (vii**bis**) to (xii) and Rule 11(2) of the Regulations under the Madrid Protocol

The Madrid System is founded on the requirement of a basic national or regional trade mark application or registration. Under the Madrid Protocol, an international application may be based on either a mark that has already been registered (‘basic registration’), or a trade mark application (‘basic application’) at any point in the trade mark examination procedure.

An applicant may choose to base its international application on several basic marks providing it is the applicant/proprietor of all the basic EUTM applications and EUTMs, even where the applications/marks, although containing identical marks, cover different goods and services.

All the basic EUTM applications or EUTMs must have been accorded a filing date, and must be in force.

The international applicant must be identical to the EUTM applicant/proprietor. The international application may not be filed by a licensee or an affiliated company of the proprietor of the basic mark(s). A deficiency in this respect may be overcome by transferring the basic mark to the international application applicant, or by recording a change of name, as applicable (see the Guidelines, [Part E, Register operations, Section 3, EUTMs and RCDs as objects of property, Chapter 1, Transfer](#)). Where there

are multiple proprietors or applicants in the basic EUTM(s) or EUTM application(s), the international application must be submitted by the same persons.

The reproduction of the mark must be identical. For full details of EUIPO practice for the identity of trade marks filed in black and white and/or greyscale, compared to those filed in colour, see the Guidelines, [Part B, Examination, Section 2, Formalities, paragraph 11.3.2](#) for priority claims, which applies by analogy. Particular attention should be paid to the following.

- Where the basic mark is protected in colour, the international application must include a colour claim.
- If the basic mark is:
  - a **word mark**, the relevant box must be ticked to request that the mark be considered as a mark in standard characters;
  - a **colour mark**, the relevant box must be ticked to declare that the mark consists of a colour or a combination of colours as such;
  - a **shape mark**, the relevant box for a three-dimensional mark must be ticked. If the representation of the basic mark was filed via computer-generated images or animated designs, applicants should consider whether the designated contracting party/ies accept(s) such files (consult the [acceptable formats](#) for representation of a mark before each office);
  - a **sound mark**, the relevant box must be ticked. If the representation of the basic mark was filed via audio file, applicants should consider whether the designated contracting party/ies accept(s) such files (consult the [acceptable formats](#) for representation of a mark before each office);
  - a **motion mark**, and the representation of the basic mark was filed via video file, applicants should consider whether the designated contracting party/ies accept(s) such files (consult the [acceptable formats](#) for representation of a mark before each office);
  - a **multimedia mark**, and the representation of the basic mark was filed via audiovisual file, applicants should consider whether the designated contracting party/ies accept(s) such files (consult the [acceptable formats](#) for representation of a mark before each office);
  - a **hologram mark**, and the representation of the basic mark was filed via video file, applicants should consider whether the designated contracting party/ies accept(s) such files (consult the [acceptable formats](#) for representation of a mark before each office).

Where the basic mark is a figurative mark, a position mark, a pattern mark, a motion mark, a multimedia mark, a hologram mark or any other type of mark (apart from a word mark, colour mark, shape mark and sound mark, mentioned above), no specific indication can be made on the international application form. Therefore, those applications will be processed without any indication of mark type. However, for clarification purposes, the EUIPO will add the trade mark type of non-traditional trade marks in the voluntary mark description field of the electronic form to be transmitted to WIPO.

- Collective or certification marks: where the basic mark is a collective or certification mark, the relevant box must be ticked.
- Description: if the basic mark includes a description, the same description may be included in the international application. If the basic mark does not include a description, a voluntary description may be added in the international application.
- Disclaimer: a disclaimer may be included even if the basic mark(s) do(es) not include one.
- Transliteration: WIPO requires a transliteration into Latin characters if the mark contains non-Latin characters. If no transliteration is given, WIPO will raise an irregularity, which must be remedied directly by the applicant. This applies to all types of trade marks, not just word marks.
- List of goods and services:
  - the list of goods and services must be identical to, or otherwise included in, the list contained in the basic mark(s) on the day the international application is filed;
  - the list of goods and services must be specified by class;
  - the list may be limited for one, several or all designated Contracting Parties and the limitation in respect of each Contracting Party may be different – it is imperative to indicate with clarity and precision the complete limited list for each Contracting Party, where such a limitation is requested.
- Translation: if the applicant does not provide a translation into the WIPO language it has chosen (Spanish, English or French) but instead authorises the EUIPO to provide the translation or to use the one available for the basic mark(s), it will not be consulted regarding the translation.

#### 2.1.3.3 Priority claim(s)

If priority is claimed, the office of earlier filing, the filing number (if available) and the filing date must be indicated. Priority documents should not be submitted. Where the earlier filing claimed as a priority right in an international application does not relate to all the goods and services, those to which it does relate should be indicated. Where priority is claimed from several earlier filings with different dates, the goods and services to which each earlier filing relates should be indicated.

#### 2.1.3.4 Form for the designation of the USA

Where the United States of America is designated, a duly completed and signed WIPO MM18 form must be attached. This form, which contains the declaration of intention to use the mark, is available only in English and must be completed in English irrespective of the language of the international application.



## 2.1.4 Examination of the international application by the EUIPO

### [Article 184 EUTMR](#)

#### Article 3(1) MP

Where examination of the international application reveals deficiencies, the EUIPO will invite the applicant to remedy them within 1 month. In principle, this short time limit should enable the EUIPO to forward the international application to WIPO within 2 months from the date of receipt and thus maintain that date as the date of the international registration.

If the deficiencies are not remedied, the EUIPO will inform the applicant that it refuses to forward the international application to WIPO. The handling fee will not be refunded.

This does not preclude the filing of another international application at a later date.

As soon as the EUIPO is satisfied that the international application is in order, it will transmit it to WIPO electronically, with the exception of documents such as the Fee Calculation Sheet or the MM18, which will be transmitted as scanned attachments. The electronic transmission will contain the certification by the office of origin referred to in Article 3(1) MP.

## 2.1.5 Irregularities found by WIPO

### Rule 11(4) and Rules 12 and 13 of the Regulations under the Protocol

If WIPO detects irregularities in the application, it will issue an irregularity notice, which will be forwarded to both the applicant and the EUIPO as the office of origin. The irregularities must be remedied by the EUIPO or the applicant, depending on their nature. Irregularities relating to the payment of the international fees must be remedied by the applicant. Any of the irregularities mentioned in Rule 11(4) of the Regulations under the Protocol must be remedied by the EUIPO.

Where there are irregularities in the classification of the goods and services, in the indication of the goods and services, or in both, the applicant cannot present its arguments directly to WIPO. Instead, they must be communicated through the EUIPO in the language of the proceedings with WIPO. In this case, the EUIPO will forward the applicant's communication to WIPO just as it is, as the EUIPO does not make use of either the option under Rule 12(2) of the Regulations under the Protocol to express a different opinion or that under Rule 13(2) of the Regulations under the Protocol to propose a remedy for the irregularity.

## 2.2 Subsequent designations

[Article 187 EUTMR](#)

[Article 65\(2\)\(b\) EUTMDR](#)

Articles [30](#) and [31](#) EUTMIR

Article 2(1)(ii) MP

Rule 1(xxvibis) and Rule 24(2) of the Regulations under the Protocol

Within the framework of the Madrid System, the holder of an international registration can extend the geographical scope of a registration's protection. There is a specific procedure called 'subsequent designation' of a registration, which extends the scope of the international registration to other members of the Madrid Union for whom either no designation has been recorded to date or the prior designation is no longer in effect. A subsequent designation may also be used to extend the scope of the goods and/or services of a prior designation, provided that the scope of the international registration is not exceeded. This could be useful in situations where a limitation has previously been recorded.

Unlike international applications, subsequent designations need not be filed through the office of origin but may be filed directly with WIPO. Direct filing with WIPO is recommended for a speedier process. If a request is filed through the EUIPO, it must be filed in the language in which the international application was filed.

Where an IR is transferred to a person who is not entitled to make a subsequent designation through the EUIPO, the application for such a subsequent designation cannot be filed through the EUIPO, but must instead be filed through WIPO or the office of the Contracting Party of the holder (for more information on entitlement to file, see [paragraph 2.1.3.1](#) above).

Subsequent designations may only be made after an initial international application has been made and has resulted in an international registration.

Subsequent designations are not subject to payment of a handling fee to the EUIPO.

Subsequent designations filed through the EUIPO must be made in the same language as the initial international application, failing which the EUIPO will refuse to forward them to WIPO. Subsequent designations must be filed using the official form: WIPO form MM4 in Spanish, English or French, or EUIPO form EM4 in the other EU languages. There is no specific EUIPO form in Spanish, English and French, as no special indications for the EUIPO are needed in those languages, and the WIPO form MM4 is, therefore, sufficient.

The Fee Calculation Sheet (Annex to WIPO form MM4) must be submitted in the language in which the subsequent designation is to be transmitted to WIPO. Alternatively, the applicant can attach a copy of the payment to WIPO. However, the

EUIPO will not examine whether the fee calculation sheet is attached, whether it is correctly filled in, or whether the amount of international fees has been correctly calculated. Any questions regarding the amount of the international fees and related means of payment should be addressed to WIPO. A fee calculator is available on WIPO's website.

In the MM4 and EM4 forms, the indications to be made are limited to those concerning the holder, the representative, the list of goods and services, and the designation of additional Contracting Parties to the MP. These indications must be made in the same way as in the MM2 form. If there is a change of holder, the entitlement to file will also be checked, namely if the international registration has been transferred to a person who is a national of an EU Member State or has his or her domicile or an establishment in the EU (the EUIPO as 'Office of the Contracting Party of the holder').

The list of goods and services may be the same as in the international registration (item 5a of the official form) or narrower (item 5b or c). It may not be broader than the scope of protection of the international registration even if covered by the basic mark.

For example, an IR for Classes 18 and 25 designating China for Class 25 can subsequently be extended to China for Class 18. However, that same IR could not subsequently be extended to China for Class 9, as this class is not covered by the international registration, even if it is covered by the basic mark.

Within these limitations, different lists may be submitted for different, subsequently designated, Contracting Parties.

The mark must be the same as in the initial international registration.

If the application is not in Spanish, English or French, the applicant must tick item 0.1 on the EUIPO EM4 form and indicate the language in which the subsequent designation is to be transmitted to WIPO. Items 0.2 and 0.3 regarding the translation of the list of goods and services and the language of correspondence between the applicant and the EUIPO must also be completed.

Where the holder so requests, a subsequent designation may take effect after specific proceedings have been concluded, namely the recording of a change or a partial cancellation in respect of the IR concerned, or the renewal of the IR.

The EUIPO must inform the applicant for territorial extension of the date on which the request for territorial extension was received.

If the request for territorial extension does not comply with the requirements outlined above, the EUIPO will invite the applicant to remedy the deficiencies within a time limit of at least 1 month. If the deficiencies are not remedied within this time limit, the EUIPO may refuse to forward the request to the International Bureau. However, the EUIPO must not refuse to forward the request to the International Bureau before the applicant has had the opportunity to correct any deficiency detected in it.

The EUIPO will forward the request for territorial extension made subsequent to the international registration to the International Bureau as soon as the requirements referred to above have been satisfied.

## 2.3 Notification of facts affecting the basic registration

Articles [49](#), [53](#), [57](#) to [62](#) and [128](#) EUTMR

[Article 29 EUTMIR](#)

If, within 5 years of the date of the international registration, the basic mark(s) cease(s) to have effect wholly or in part, the international registration is cancelled to the same extent, since it is 'dependent' thereon. This occurs not only in the event of a 'central attack' by a third party, but also if the basic mark(s) lapse(s) due to action or inaction on the part of its proprietor.

For EUTMs, this covers cases where, either fully or partially (i.e. for only some goods or services),

- the EUTM or the EUTM application(s) on which the IR is based is (are) withdrawn, considered to be withdrawn, or refused;
- the EUTM(s) on which the IR is based is (are) surrendered, not renewed, revoked or declared invalid by the EUIPO or, on the basis of a counterclaim in infringement proceedings, by an EUTM court.

Where the above occurs as a result of a decision (by the EUIPO or an EUTM court), the decision must be final.

If the above occurs within the 5-year period, the EUIPO must notify WIPO accordingly.

The EUIPO must check that the international application has actually been registered before notifying WIPO that the basic EUTM has ceased to have effect.

WIPO must also be notified in certain cases where a procedure has been initiated prior to expiry of the 5-year period but is not finally decided within that period. This notification is to be made at the end of the 5-year period. The cases involved are:

- a pending refusal of the basic EUTM application(s) on absolute grounds (including appeals before the Boards of Appeal or the GC/CJEU);
- pending opposition proceedings against the basic EUTM application (including appeals before the Boards of Appeal or the GC/CJEU);
- pending cancellation proceedings before the EUIPO against the basic EUTM (including appeals before the Boards of Appeal or the GC/CJEU);
- where mention has been made in the Register of EU trade marks that a counterclaim in infringement proceedings against the basic EUTM has been filed before an EU trade mark court, but no mention has yet been made in the Register of the decision of the EU trade mark court on the counterclaim.

Once a final decision has been taken or the proceedings have been terminated, a further notification must be sent to WIPO stating whether and to what extent the basic mark(s) has (have) ceased to have effect or remained valid.

If, within 5 years of the date of the international registration, the basic EUTM(s) or EUTM application(s) is (are) divided or partially transferred, WIPO must also be

notified. However, in those cases, there will be no effect on the validity of the international registration. The purpose of the notification is merely to keep a record of the number of mark(s) on which the IR is based.

No other changes in the basic mark(s) will be reported to WIPO by the EUIPO. Where the applicant/holder wishes to record the same changes in the International Register it should apply for this separately (see [paragraph 2.4](#) below).

## **2.4 Forwarding of changes affecting the international mark**

The International Register is kept at WIPO. The possible changes listed below may only be recorded once the mark has been registered.

The EUIPO will not process requests for renewal or payments of renewal fees.

In principle, most changes relating to international registrations can be filed either directly with WIPO by the holder of the international registration on record, or through the office of the Contracting Party of the holder. However, some applications for changes can be filed by another party and through another office, as detailed below.

### **2.4.1 Cases where applications for changes can be forwarded without examination**

Rules 20 and 20 <i>bis</i> and Rule 25(1) of the Regulations under the Protocol
---

The following applications for changes relating to an international registration can be presented to the EUIPO as an 'office of the Contracting Party of the holder':

- WIPO form MM5: change of ownership, either total or partial, submitted by the IR holder on record (in EUTM terminology, this corresponds to a transfer);
- WIPO form MM6: limitation of the list of goods and services for all or some Contracting Parties;
- WIPO form MM7: renunciation of one or more Contracting Parties (not all);
- WIPO form MM8: full or partial cancellation of the international registration;
- WIPO form MM9: change of the name or address of the holder and/or change in the indication of the legal nature where the holder is a legal entity;
- WIPO forms MM13/MM14: new licence or amendment to a licence submitted by the IR holder on record;
- WIPO form MM15: cancellation of the recording of a licence;
- WIPO form MM19: restriction of the holder's right of disposal submitted by the IR holder on record (in EUTM terminology, this corresponds to the rights in rem, levy of execution, enforcement measures or insolvency proceedings contemplated in Articles [22](#), [23](#) and [24](#) EUTMR).

Such applications made to the EUIPO by the IR holder will simply be forwarded to WIPO without further examination. The provisions under the EUTMR for the corresponding proceedings do not apply. In particular, the language rules applicable

are those under the Regulations under the Protocol, and there is no EUIPO fee to be paid.

These applications can only be filed through the EUIPO if it is the office of origin or if it acquires competence in respect of the holder as a result of the transfer of the international registration (see Rule 1(xxvibis) of the Regulations under the Protocol). The applications for which the EUIPO is competent (as office of origin) will simply be forwarded to WIPO. The applications for which the EUIPO is not competent (i.e. when it is not the office of origin) will not be dealt with.

No use will be made of the options provided in Rule 20(1)(a) of the Regulations under the Protocol that allow an office of the Contracting Party of the holder to notify the International Bureau of a restriction of the holder's right of disposal on its own motion.

#### **2.4.2 Cases where requests for changes will be forwarded after examination**

##### [Article 201 EUTMR](#)

Rule 20(1)(a), Rule 20bis(1) and Rule 25(1)(b) of the Regulations under the Protocol

The Regulations under the Protocol provide that requests for recording a change of ownership, a licence or a restriction of the holder's right of disposal may only be filed directly with WIPO by the holder of the international registration. It would be practically impossible to record a change of ownership or licence with WIPO where:

- the original holder no longer exists (merger, death), or
- the holder is either not cooperating with its licensee or (even more likely) is the beneficiary of an enforcement measure.

For these reasons, the new holder, licensee or beneficiary of the right of disposal has no choice but to file their request with the office of the Contracting Party of the holder. WIPO will register such requests, without any substantive examination, on the basis that they have been transmitted by that office.

To avoid a third party becoming the owner or licensee of an international registration, it is imperative that the EUIPO examine all requests presented by any party other than the holder of the IR, in order to verify that there is proof of the transfer, licence or other right, as provided in [Article 201 EUTMR](#). The EUIPO limits itself to examining proof of the transfer, licence or other right, with Articles [20](#) and [26](#) EUTMR and [Article 13 EUTMR](#) and the corresponding parts of the EUIPO Guidelines on transfers, licences, rights *in rem*, levies of execution and insolvency proceedings or similar proceedings applying by analogy. If no proof is submitted, the EUIPO will refuse to forward the request to WIPO. This decision may be appealed.

In all other respects, the rules under the EUTMR do not apply. In particular, the request must be in one of the WIPO languages and on the appropriate WIPO form, and no fee is payable to the EUIPO.

## 3 The EUIPO as Designated Office

### 3.1 Overview

Any person who is a national of, or has a domicile or commercial establishment in, a State that is party to the MP and who is the owner of a national application or registration in that same State (a 'basic mark') may, through the national office where the basic mark is applied for or registered (the 'office of origin'), file an international application or a subsequent designation in which they can designate the European Union.

Once it has examined the classification and checked certain formalities (including payment of fees), WIPO will publish the IR in the WIPO Gazette, issue the certificate of registration and notify the designated offices of the international registration. The EUIPO receives the data from WIPO exclusively in electronic form.

International registrations designating the EU are identified by the EUIPO under their WIPO registration number, preceded by a '**W**' and followed by a '**0**' in the case of a new IR (e.g. **W01** 234 567) and a '**1**' in the case of a subsequent designation (e.g. **W10** 987 654). Further designations of the EU for the same IR will be identified as **W2**, **W3**, etc. However, when searching in EUIPO databases online, the '**W**' should not be entered.

The type of mark displayed in the EUIPO's database by default will depend on whether the indication appears in the International Register under INID code 541 ('Reproduction of the mark where the mark is represented in standard characters'), INID code 550 ('Indication relating to the nature or kind of mark' for three-dimensional mark or sound mark) or INID code 558 ('Mark consisting exclusively of one or several colors'). If none of the above is preselected, the mark will be incorporated as a figurative mark into the EUIPO's database.

The EUIPO has 18 months to inform WIPO of all possible grounds for refusal of the EU designation. The 18-month period starts on the day on which the EUIPO is notified of the designation.

Where corrections are received from WIPO that affect the mark itself, the goods and services or the designation date, it corresponds to the EUIPO to decide if a new 18-month period is to start running from the new notification date. Where a correction affects only part of the goods and services, the new time limit applies only to that part and the EUIPO has to republish the IR in part in the EUTM Bulletin and reopen the opposition period only for that part of the goods and services.

The main tasks performed by the EUIPO as designated office are:

- first republication in the EUTM Bulletin;

- examination of formalities, including examination of limited lists for the EU designation, of the clarity and precision of the terms in the specification of goods and services, and of seniority claims;
- examination of absolute grounds;
- examination of oppositions;
- processing of communications from WIPO concerning changes to the IRs;
- second republication in the EUTM Bulletin;
- issue of grants of protection or final decisions.

## 3.2 Professional representation

[Article 119\(2\)](#) and [Article 120 EUTMR](#)

In principle, the IR holder does not need to appoint a representative before the Office.

Holders outside the European Economic Area (EEA) are, however, required to be represented: (a) further to a provisional refusal, (b) for filing seniority claims directly before the Office, or (c) further to an objection to a seniority claim (see the Guidelines, [Part A, General Rules, Section 5, Professional Representation](#) , and Articles [119](#) and [120](#) EUTMR).

In any of the above situations, where the IR holder has appointed a representative before WIPO who also appears in the database of representatives maintained by the Office, this representative will automatically be considered to be the IR holder's representative before the Office.

Where a non-EEA IR holder has not appointed a representative or has appointed a representative before WIPO who does not appear in the database of representatives maintained by the Office, any notifications of provisional refusal or objection will contain an invitation to appoint a representative in compliance with Articles [119](#) and [120](#) EUTMR. For the particularities of representation in each of the proceedings before the Office, see paragraphs [3.3.3](#) , [3.4](#) and [3.6.6](#) below.

## 3.3 First republication, searches and formalities

### 3.3.1 First republication

[Article 190 EUTMR](#)

On receipt, IRs will immediately be republished <sup>89</sup> in Part M.1 of the EUTM Bulletin, except where the second language is missing.

---

<sup>89</sup> IRs are published first in the WIPO Gazette of International Marks and then 'republished' by the Office.



Publication will be limited to bibliographic data, the reproduction of the mark and the class numbers, and will not include the actual list of goods and services. This means, in particular, that the EUIPO will not translate international registrations or the list of goods and services. The publication will also indicate the first and second languages of the IR and contain a reference to the publication of the IR in the WIPO Gazette, which should be consulted for further information. For more details, reference is made to the EUTM Bulletin on the EUIPO's website.

The international registration has, from the date of first republication, the same effect as a published EUTM application.

### 3.3.2 Searches

#### [Article 195 EUTMR](#)

On request of the IR holder within a period of 1 month from when WIPO informs the Office of the designation, the Office will draw up a European Union search report for each IR, which will cite similar EUTMs and IRs designating the EU. The owners of the earlier marks cited in the report will receive a surveillance letter in accordance with [Article 195\(4\) EUTMR](#), unless they ask the Office not to send them such letters. In addition, on request by the international holder, the Office will send the IR to the participating national offices to have national searches carried out (see the Guidelines, [Part B, Examination, Section 1, Proceedings](#)).

The national search request must be filed directly with the Office. Holders of IRs designating the EU must request the national searches and pay the corresponding fee within a period of 1 month from when WIPO informs the Office of the designation. Late or missing payments of search fees will be dealt with as if the request for national searches had not been filed.

Payment can be made using any of the means of payment accepted by the Office (see the Guidelines, [Part A, General Rules, Section 3, Payment of Fees, Costs and Charges, paragraph 2](#)).

The holder will not be required to appoint a representative before the EUIPO for the sole purpose of requesting or receiving search reports.

The search reports requested will be sent directly to the IR holder or, if the latter has appointed a representative before the Office, to that representative. When a representative has been considered to be the IR holder's representative before the Office in any of the situations described under paragraph [3.2](#), the search reports will also be sent to that representative.

### 3.3.3 Formalities examination

The formalities examination carried out by the EUIPO on IRs is limited to whether a second language has been indicated, whether the application is for a collective or a certification mark (which must include the submission of the regulations governing the use of the mark), whether the limited lists for the EU designation fall within the scope of the IR's main list, whether there are any seniority claims and whether the list of goods and/or services meets the requirements of clarity and precision as described in the Guidelines, [Part B, Examination, Section 3, Classification](#).

#### 3.3.3.1 Languages

[Article 146\(3\), \(4\) and \(8\)](#), and Articles [193](#) and [206](#) EUTMR

Rule 9(5)(g)(ii) of the Regulations under the Protocol

Rule 9(5)(g)(ii) of the Regulations under the Protocol and [Article 206 EUTMR](#) require the applicant for an international application designating the EU to indicate a second language, different from the first one, selected from the four remaining languages of the EUIPO by ticking the appropriate box in the contracting parties' section of WIPO forms MM2 or MM4.

Under the terms of [Article 206 EUTMR](#), the language of filing of the international application is the language of the proceedings within the meaning of [Article 146\(4\) EUTMR](#). If the language chosen by the international registration holder in written proceedings is not the language of the international application, the holder must supply a translation into that language within 1 month from when the original document was submitted. If the translation is not received within this time limit, the original document is considered not to have been received by the EUIPO.

The second language indicated in the international application must be a second language within the meaning of [Article 146\(3\) EUTMR](#), that is, a language of proceedings accepted as possible for opposition, revocation or invalidity proceedings before the EUIPO.

Where no second language has been indicated, the examiner will issue a provisional refusal of protection and give the holder 2 months from the day on which the EUIPO issues the provisional refusal pursuant to [Article 193\(5\) EUTMR](#) to remedy the deficiency. Where necessary, the notification of provisional refusal will invite the IR holder to appoint a representative in compliance with Articles [119](#) and [120](#) EUTMR. This notification will be recorded in the International Register, published in the Gazette and sent to the IR holder. The reply to the provisional refusal must be addressed to the EUIPO.

If the IR holder remedies the deficiency and complies with the requirement, if applicable, to appoint a representative before the EUIPO within the prescribed time limit, the IR will proceed to republication.

If the deficiency has not been remedied and/or a representative, if applicable, has not been appointed, the EUIPO will confirm the refusal to the IR holder. The holder has 2 months within which to lodge an appeal. Once the decision is final, the EUIPO will inform WIPO that the provisional refusal is confirmed.

### 3.3.3.2 Collective and certification marks

Articles [74 to 76](#), [83](#), [84](#) and [194](#) EUTMR

Articles [16](#), [17](#) and [33](#) EUTMIR

[Article 76](#) EUTMDR

In the EUTM system, there are three kinds of mark: individual marks, collective marks and certification marks (for more details, see the Guidelines, [Part B, Examination, Section 2, Formalities](#)).

The international application form contains one single indication, grouping collective marks, certification marks and guarantee marks. Therefore, an IR designating the EU that is based on a national certification mark, guarantee mark or collective mark will be entered as either an EU collective mark or an EU certification mark and will entail the payment of higher fees.

The conditions applying to EU collective marks and EU certification marks will also apply to corresponding IRs designating the EU. For more information on the examination requirements, see the Guidelines, [Part B, Examination, Section 2, Formalities](#) (paragraphs [9.2](#) and [9.3](#)) and the Guidelines, Part B, Examination, Section 4, Absolute Grounds for Refusal, [Chapter 15, European Union Collective Marks](#) and [Chapter 16, European Union Certification Marks](#).

In accordance with [Article 194 EUTMR](#), the holder must submit the regulations governing use of the mark directly to the EUIPO within 2 months of the date on which the International Bureau notified the EUIPO of the designation. These regulations must be submitted in the language of proceedings.

From the examination of the particulars of the mark and the content of the regulations governing use of the mark, the EUIPO will determine if the designation is for a collective or for a certification mark.

If the regulations on use have not yet been submitted or contain irregularities, or the holder does not comply with the requirements of Articles [74](#) or [83](#) EUTMR, the examiner will issue a provisional refusal of protection and give the holder 2 months from the day on which the EUIPO issues the provisional refusal pursuant to [Article 33 EUTMIR](#) to remedy the deficiency. Where necessary, the notification of provisional refusal will invite the IR holder to appoint a representative in accordance with Articles [119](#) and [120](#) EUTMR. This notification will be recorded in the International Register, published in the Gazette and sent to the IR holder. The reply to the provisional refusal must be addressed to the EUIPO.

If the IR holder remedies the deficiency and complies with the requirement, if applicable, to appoint a representative before the EUIPO within the prescribed time limit, the international registration will proceed.

If the deficiency has not been remedied and/or a representative, if applicable, has not been appointed, the Office will confirm the refusal to the IR holder, and grant a 2-month time limit for lodging an appeal. Once the decision is final, the Office will inform WIPO that the provisional refusal is confirmed.

### 3.3.3.3 Seniority claims

#### Seniority claims filed together with the designation

##### [Article 191 EUTMR](#)

Rule 9(5)(g)(i) and Rule 21*bis* of the Regulations under the Protocol

The applicant may, when designating the EU in an international application or a subsequent designation, claim the seniority of an earlier mark registered in a Member State. Such a claim must be submitted by attaching form MM17 to the international application or subsequent designation request, which should include for each claim:

- the EU Member State in which the earlier right is registered;
- the registration number;
- the filing date of the relevant registration.

There is no equivalent provision to [Article 39\(2\) EUTMR](#) applicable to direct EUTM filings.

No certificates or documents in support of the seniority claims should be attached to the MM17 form, as they will not be transmitted to the EUIPO by WIPO.

Seniority claims submitted together with the international application or subsequent designation will be examined in the same way as seniority claims submitted with an EUTM application. For more information, please refer to [the Guidelines, Part B, Examination, Section 2, Formalities](#).

If it is necessary to file documentation in support of the seniority claim, or if the claim contains irregularities, the examiner will issue a deficiency letter giving the IR holder 2 months within which to remedy the deficiency. Where necessary, the IR holder will also be invited to appoint a representative before the EUIPO.

If the seniority claim is accepted by the EUIPO, the IP offices concerned will be informed. WIPO does not need to be informed as no change in the International Register is required.

If the deficiency has not been remedied and/or a representative, if applicable, has not been appointed, the right of seniority will be lost pursuant to [Article 191\(4\) EUTMR](#). The IR holder may request a decision, which can be appealed. Once the decision is final, the EUIPO will inform WIPO of any loss, refusal or cancellation of the seniority

right or of any withdrawal of the seniority claim. Those changes will be recorded in the International Register and published by WIPO.

Seniority claims submitted after acceptance of the EU designation by the EUIPO

[Article 192 EUTMR](#)

[Article 32 EUTMIR](#)

Rule 21*bis*(2) of the Regulations under the Protocol

Upon publication of the final acceptance of the IR in the EUTM Bulletin, the IR holder may claim the seniority of an earlier mark registered in a Member State by filing a request directly with the EUIPO. Any such request filed before WIPO will be considered not to have been filed.

Any seniority claim submitted in the interval between the filing of the international application and the publication of the final acceptance of the IR will be considered to have been received by the EUIPO on the date of publication of the final acceptance of the IR and will therefore be examined by the EUIPO after that date.

If it is necessary to submit documentation in support of the seniority claim or if the claim contains irregularities or the appointment of a representative before the EUIPO is required, the examiner will issue a deficiency letter giving the IR holder 2 months within which to remedy the deficiency.

If the seniority claim is accepted by the Office, it will inform WIPO, which will record this fact in the International Register and publish it.

The IP offices concerned will be informed pursuant to [Article 35\(4\) EUTMR](#).

If the deficiency is not remedied and/or a representative, if applicable, has not been appointed, the right of seniority will be refused and the IR holder will be given 2 months within which to lodge an appeal. In such cases, WIPO is not informed. The same applies if the seniority claim is abandoned.

#### 3.3.3.4 Terms lacking clarity and precision

Articles [33](#), [41](#), [182](#) and [193](#) EUTMR

[Article 33 EUTMIR](#)

International registrations designating the EU are examined for the specification of terms lacking clarity and precision in the list of goods and services in the same way as direct EUTM applications (see the Guidelines, [Part B, Examination, Section 3, Classification](#)).

Before filing an IR designating the EU, the content of the Harmonised Database (HDB) can be searched using TMclass (<http://tmclass.tmdn.org>). The HDB brings together terms that are accepted for classification purposes in all EU offices. Users can select these pre-approved terms, provided they fall within the scope of the basic mark, to

build their list of goods and services and simultaneously see if they are also included in WIPO's MGS — Madrid Goods & Services Manager (<https://webaccess.wipo.int/mgs/>). All HDB terms will be accepted by the Office automatically. Checking in advance that the goods and/or services are included in both TMclass and the MGS database will help make the trade mark registration process smoother for IRs designating the EU.

Where the IR contains terms in the list of goods and/or services, which lack clarity or precision, the EUIPO will issue a provisional refusal of protection and give the holder 2 months from the day on which the EUIPO issues the provisional refusal pursuant to [Article 33 EUTMR](#) and [Article 33 EUTMIR](#) to remedy the deficiency. Where necessary, the notification of provisional refusal will invite the IR holder to appoint a representative in accordance with Articles [119](#) and [120](#) EUTMR. This notification will be recorded in the International Register, published in the Gazette and sent to the IR holder. The reply to the provisional refusal must be addressed to the EUIPO.

Once the provisional refusal has been sent, further examination is the same as for a direct EUTM application. There will be direct exchanges with the IR holder or its representative as often as is required. The terms that need to be clarified by the IR holder should always be in the same class as the original wording in the International Register.

If, after re-examining the case, the objection is waived or the IR holder remedies the deficiency and complies with the requirement, if applicable, to appoint a representative before the EUIPO within the prescribed time limit, the EUIPO will issue an interim status of the mark to WIPO, provided that no other *ex officio* provisional refusal is pending and that the opposition period is still running.

Replies received from the IR holder or its representative will not be addressed where both are located outside the EEA.

If the holder fails to overcome the objections or fails to respond to the objection, the provisional refusal will be confirmed. In other words, if the provisional refusal concerned only some of the goods and services, only those goods and services will be refused but the remaining goods and services will be accepted. The IR holder will be given 2 months within which to lodge an appeal.

Once the decision is final and provided that there is a total refusal, the EUIPO will inform WIPO that the provisional refusal is confirmed. If the refusal is only partial, the communication to WIPO will be issued once all the other procedures have been completed or the opposition period is over without any opposition being received (see [paragraph 3.9](#) below).

### 3.3.3.5 Limited list of goods and services for the designation of the EU

Where a limited list of goods and services is sought for the designation of the EU, the EUIPO will examine whether the goods and services sought are comprised within the main list of goods and services of the international registration.

Where the limited list for the EU contains terms that are not comprised within the main list of goods and services of the IR, the EUIPO will issue a provisional refusal of

protection and give the IR holder 2 months from the day on which the provisional refusal is issued to remedy the deficiency. Where necessary, the notification of provisional refusal will invite the IR holder to appoint a representative in compliance with Articles [119](#) and [120](#) EUTMR. This notification will be recorded in the International Register, published in the Gazette and sent to the IR holder. The reply to the provisional refusal must be addressed to the EUIPO.

Once the provisional refusal has been sent, further examination is the same as for a direct EUTM application. There will be direct exchanges with the IR holder or its representative as often as is required.

If, after re-examining the case, the objection is waived or the IR holder remedies the deficiency and complies with the requirement, if applicable, to appoint a representative before the EUIPO within the prescribed time limit, the EUIPO will issue an interim status of the mark to WIPO, provided that no other *ex officio* provisional refusal is pending and that the opposition period is still running; the IR will then proceed.

Replies received by the IR holder or its representative will not be addressed where both are located outside the EEA.

If the holder fails to overcome the objections or to convince the examiner that they are unfounded, or fails to respond to the objection, the provisional refusal will be confirmed. In other words, if the provisional refusal concerned only some of the goods and services, only those goods and services will be refused but the remaining goods and services will be accepted. The IR holder will be given 2 months within which to lodge an appeal.

Once the decision is final and provided that there is a total refusal, the EUIPO will inform WIPO that the provisional refusal is confirmed. If the refusal is only partial, the communication to WIPO will be issued once all the other procedures have been completed or the opposition period is over without any opposition being received (see [paragraph 3.9](#) below).

### 3.4 Absolute grounds for refusal

[Article 193 EUTMR](#)

[Article 33 EUTMIR](#)

Rule 18*bis*(1) of the Regulations under the Protocol

International registrations designating the EU will be subject to examination of absolute grounds for refusal in the same way as direct EUTM applications (see the Guidelines, [Part B, Examination, Section 4, Absolute Grounds for Refusal](#)).

If the EUIPO finds that the mark is eligible for protection, and provided that no other provisional refusal is pending, it will send an interim status of the mark to WIPO, indicating that the *ex officio* examination has been completed, but that the IR is still



open to oppositions or third-party observations. This notification will be recorded in the International Register, published in the Gazette and communicated to the IR holder.

If the EUIPO finds that the mark is not eligible for protection, it will send a provisional refusal of protection, giving the IR holder 2 months from the day on which the provisional refusal is sent to submit observations. Where necessary, the notification of provisional refusal will also invite the holder to appoint a representative in compliance with Articles [119](#) and [120](#) EUTMR. This notification will be recorded in the International Register, published in the Gazette and communicated to the IR holder. The reply to the provisional refusal must be addressed to the EUIPO.

If, after re-examining the case, the objection is waived, the examiner will issue an interim status of the mark to WIPO, provided that no other provisional refusal is pending and the opposition period is still running.

However, the EUIPO still has the possibility of reopening the examination of absolute grounds on its own initiative at any time before the final statement of grant of protection, but not beyond the 18-month period the EUIPO has for informing WIPO of all possible grounds for refusal (see [paragraph 3.1](#) above).

Once the provisional refusal has been sent, further examination is the same as for a direct EUTM application. Direct exchanges with the holder or its representative will be held as often as required.

Replies received by the IR holder or its representative will not be addressed where both are located outside the EEA.

If the holder fails to overcome the objections or convince the examiner that they are unfounded, or fails to respond to the objection, the refusal will be confirmed. In other words, if the provisional refusal concerned only some of the goods and services, only those goods and services will be refused but the remaining goods and services will be accepted. The IR holder will be given 2 months within which to lodge an appeal.

Once the decision is final and provided that there is a total refusal, the EUIPO will inform WIPO that the provisional refusal is confirmed. If the absolute grounds refusal is only partial, the communication to WIPO will be issued once all other procedures are terminated or the opposition period is over with no opposition received (see [paragraph 3.9](#) below).

### **3.5 Third-party observations**

[Article 45](#) and [Article 193\(7\) EUTMR](#)

Third-party observations can be validly filed at the EUIPO from the date of notification of the IR to the EUIPO until at least the end of the opposition period and, if an opposition was filed, as long as the opposition is pending, but not beyond the 18-month period the EUIPO has for informing WIPO of all possible grounds for refusal (see [paragraph 3.1](#) above).



If third-party observations are received before the EUIPO communicates the outcome of the absolute grounds examination to WIPO, and the EUIPO considers the observations justified, a provisional refusal will be issued.

If third-party observations are received after a provisional refusal on absolute grounds has been issued for goods and services other than those to which the observations relate, and the EUIPO considers the observations justified, a further provisional refusal will be issued.

If third-party observations are received after an interim status of the mark has been issued and the EUIPO considers them justified, a provisional refusal further to third-party observations will be issued. The observations will be attached to the provisional refusal.

The further examination procedure is identical to the procedure described in the Guidelines, [Part B, Examination, Section 1, Proceedings, paragraph 3.1](#).

If the EUIPO considers the observations unjustified, they will simply be forwarded to the applicant without WIPO being informed.

## 3.6 Opposition

[Article 196 EUTMR](#)

Articles [77](#) and [78](#) EUTMDR

### 3.6.1 Timing

Oppositions may be filed against the international registration between the first month and the fourth month following the date of first republication. For example, if the first republication is on 15/02/2017, the opposition period starts on 15/03/2017 and ends on 15/06/2017.

The opposition period is fixed and is independent of the outcome of the procedure on absolute grounds. Nevertheless, the start of the opposition procedure depends on the outcome of the *ex officio* examination insofar as the opposition procedure may be suspended if an *ex officio* refusal has been issued in relation to the same goods and services.

Oppositions filed after the republication of the IR but prior to the start of the opposition period will be kept on hold and be considered to have been filed on the first day of the opposition period. If the opposition is withdrawn before that date, the opposition fee is refunded.

### 3.6.2 Receipt and informing the international holder

[Article 4](#) and [Article 77\(3\) EUTMDR](#)

The EUIPO will issue a receipt to the opponent. If the opposition has been received before the beginning of the opposition period, a letter will be sent to the opponent, informing them that the opposition will be considered to have been received on the first day of the opposition period and that the opposition will be put on hold until then.

The EUIPO will also inform the IR holder or the representative before WIPO (if the holder has appointed a representative before WIPO and the EUIPO holds sufficient contact information) of the filing of the opposition and the number of the same, even if the place of business is outside the EEA.

### 3.6.3 Fees

[Article 99](#) and [Article 196\(2\) EUTMR](#)

The opposition will not be treated as duly entered until the opposition fee has been paid. If payment of the fee within the opposition period cannot be established, the opposition will be considered not to have been entered.

If the opponent disagrees with this finding, it has the right to request a formal decision on loss of rights. If the EUIPO decides to confirm the finding, both parties will be informed thereof. If the opponent appeals this decision, the EUIPO will issue a provisional refusal to WIPO, even if incomplete, for the sole purpose of meeting the 18-month time limit. If the decision becomes final, the provisional refusal will be reversed. Otherwise, the opposition procedure will start in the normal manner.

### 3.6.4 Admissibility check

[Article 119\(2\) EUTMR](#)

Articles [5](#) and [78](#) EUTMDR

The EUIPO will examine whether the opposition is admissible and whether it contains the particulars required by WIPO.

If the opposition is considered inadmissible, the EUIPO will inform the IR holder accordingly and no provisional refusal based on an opposition will be sent to WIPO.

For full details on opposition proceedings, see the Guidelines, [Part C, Opposition, Section 1, Opposition Proceedings](#).

### 3.6.5 Language of proceedings

[Article 146\(6\) EUTMR](#)

[Article 3 EUTMDR](#)

Oppositions (like requests for cancellation) must be filed in the language of the international registration (the first language) or in the second language that the international holder is obliged to indicate when designating the EU. The opponent may choose either of these two languages as the language of the opposition proceedings. The opposition may also be filed in any of the other three EUIPO languages, provided that a translation into the language of the proceedings is filed within 1 month.

The EUIPO will use:

- the language of the opposition proceedings chosen by the opponent in all communications made directly to the parties;
- the language in which the IR was registered by WIPO (first language) in all communications with WIPO, such as, the provisional refusal.

### 3.6.6 Representation of the IR holder

#### 3.6.6.1 Opposition receipts

[Article 4 EUTMDR](#)

If applicable, the EUIPO will, in the opposition receipt, inform the representative before WIPO that if the IR holder does not appoint a representative who complies with the requirements in Articles [119\(3\)](#) or [120](#) EUTMR within 1 month of receipt of the communication, the EUIPO will communicate the formal requirement to appoint a representative to the IR holder together with the opposition deadlines once the opposition is found admissible.

Where the IR holder has a WIPO representative **within** the EEA who does not appear in the database of representatives maintained by the EUIPO, the EUIPO will inform this representative that, if they wish to represent the IR holder before the EUIPO, they must specify the basis of their entitlement (i.e. whether they are a legal practitioner or professional representative within the meaning of [Article 120\(1\)\(a\) or \(b\) EUTMR](#) or an employee representative within the meaning of [Article 119\(3\) EUTMR](#)) (see the Guidelines, [Part A, General Rules, Section 5, Professional Representation](#)).

### 3.6.6.2 Notification of commencement of opposition proceedings

#### [Article 6\(1\) EUTMDR](#)

If the opposition has been found admissible and where, despite the invitation pursuant to [paragraph 3.6.6.1](#) above, the IR holder fails to appoint a representative before the opposition has been found admissible, further processing of the file will depend on whether or not the **IR holder** is required to be represented before the EUIPO pursuant to [Article 119\(2\) EUTMR](#).

- If the IR holder is **not** required to be represented before the EUIPO, the proceedings will continue directly with the IR holder, that is, the IR holder will be sent notification of the admissibility of the opposition and the time limits set for substantiation.
- If the IR holder **is** required to be represented before the EUIPO, the IR holder will be notified of the admissibility of the opposition and will be formally requested to appoint a representative within 2 months of receipt of the communication ([Article 77\(4\) EUTMDR](#)), failing which the IR will be refused with a right to appeal. Once the decision is final, the opposition proceedings will be closed and WIPO will be informed. For the attribution of costs, the normal rules apply. This means that no decision on costs will be taken and the opposition fee will not be refunded.

### 3.6.7 Provisional refusal (based on relative grounds)

#### [Article 78 EUTMDR](#)

Article 5(1) and Article 5(2)(a) and (b) MP

Rule 17(1)(a) and (2)(v) of the Regulations under the Protocol

Any opposition that is considered to have been entered and is admissible will lead to a notification of provisional refusal being sent to WIPO based on the pending opposition. WIPO will be informed of every admissible opposition duly entered within the opposition period by means of a separate provisional refusal for each opposition.

The provisional refusal may be partial or total. It will contain details of the earlier rights invoked, including their representation, the relevant list of goods and services on which the opposition is based and, in the case of a partial refusal, the list of goods and services against which the opposition is directed.

The opponent must provide the list of goods and services on which the opposition is based in the language of the opposition proceedings. The EUIPO will send this list to WIPO in that language and will not translate it into the language in which the international registration was registered.

This notification will be recorded in the International Register, published in the Gazette and communicated to the IR holder. The time limit for commencement of the

proceedings will be set in the direct notification to the parties made in parallel by the EUIPO, as in the case of a normal EUTM.

### **3.6.8 Suspension of opposition where there is a pending *ex officio* provisional refusal**

Articles [6\(2\)](#) and [77\(5\)](#) EUTMDR

If the opposition was filed after the EUIPO had already issued one or more *ex officio* provisional refusal(s) for the same goods and services, the EUIPO will inform WIPO of the provisional refusal based on the opposition and communicate to the parties that, as from the date of the communication, the opposition procedure is suspended until a final decision has been issued in relation to the *ex officio* refusals.

If the *ex officio* provisional refusal(s) lead(s) to a final refusal of protection for all goods and services or for those contested by the opposition, the opposition procedure is closed without proceeding to a decision and the opposition fee is refunded.

If the *ex officio* refusal(s) is/are not maintained or is/are only partially maintained, the opposition procedure is resumed for the remaining goods and services.

## **3.7 Cancellation of the IR or renunciation of the EU designation**

If, further to an *ex officio* provisional refusal or a provisional refusal on relative grounds, the holder requests the cancellation of the IR from the International Register or renounces its designation of the EU, the file is closed upon receipt of the notification by WIPO. Therefore, it is strongly recommended that the holder inform the Office at the same time as submitting its request to WIPO. The Office will then suspend the refusal procedure pending receipt of the notification of cancellation or renunciation from WIPO.

If this happens before the start of the adversarial part of the opposition proceedings, the opposition fee is reimbursed to the opponent, since it is equivalent to withdrawal of the EUTM application. The IR holder must submit such requests to WIPO (or through the office of origin) using the official form (MM7/MM8). The EUIPO cannot act as an intermediary and will not forward these requests to WIPO.

However, cancellation of the IR at the request of the office of origin (due to a 'central attack' during the 5-year dependency period) is considered equivalent to rejection of the EUTM application in parallel proceedings under [Article 6\(2\) EUTMDR](#). In this case the opposition fee is not reimbursed.

### 3.8 Limitations of the list of goods and services

Article 9*bis*(iii) MP

Rule 25 of the Regulations under the Protocol

Where there is no provisional refusal pending, all limitations can be filed only through WIPO. The same applies to limitations filed during invalidity or revocation procedures. WIPO will record the limitation and forward it to the EUIPO for examination.

Further to a provisional refusal, limitations can be filed through WIPO or submitted directly to the EUIPO.

The IR holder should inform the Office as soon as it submits the limitation request (MM6/MM8) to WIPO. The refusal procedure will then be suspended pending receipt of the notification of limitation from WIPO (i.e. once the limitation is entered in WIPO's Register). Provided the limitation allows the objection to be waived, the EUIPO will communicate to WIPO that the provisional refusal is withdrawn.

If, further to a provisional refusal, the IR holder chooses to limit the list of goods and services by submitting its request for limitation to the EUIPO, instead of through WIPO, the EUIPO will simply confirm the provisional refusal. As a consequence, WIPO's Register will reflect the partial refusal, not the limitation as such.

In all cases, limitations will be examined by the EUIPO in the same way as limitations or partial surrenders of an EUTM or an EUTM application (see the Guidelines, [Part B, Examination, Section 3, Classification](#), and [Part E, Register Operations, Section 1, Changes in a Registration](#)). When the limitation has been submitted through WIPO and is considered unacceptable by the EUIPO, a declaration that the limitation has no effect in the territory of the EU will be issued pursuant to Rule 27(5) of the Regulations under the Protocol. This declaration will not be subject to review or appeal.

**The request for limitation must be submitted through WIPO in all cases where the IR holder wishes to apply for a conversion request.**

Partial cancellations at the request of the office of origin (further to a 'central attack' during the 5-year dependency period) will be recorded, as they are by the EUIPO.

If the limitation is submitted before the start of the adversarial part of the opposition proceedings and allows the opposition proceedings to be terminated, the opposition fee is reimbursed to the opponent.

### 3.9 Confirmation or withdrawal of provisional refusal and issuance of statement of grant of protection

[Article 33\(2\) EUTMIR](#)

Articles [78\(5\)](#) and [79\(1\)](#) EUTMDR

Rule 18ter(1) to (3) of the Regulations under the Protocol

If one or several notifications of provisional refusal have been sent to WIPO, the EUIPO must perform either one of the following options once all procedures have been completed and all decisions are final.

- Confirm the provisional refusal(s) to WIPO.
- Send a statement of grant of protection to WIPO indicating that the provisional refusal(s) is/are partially or totally withdrawn. The statement of grant of protection must specify for which goods and services the mark is accepted.

If, upon expiry of the opposition period, the IR has not been the subject of any provisional refusal, the EUIPO will send a statement of grant of protection to WIPO for all the goods and services.

The statement of grant of protection must include the date on which the IR was republished in Part M.3 of the EUTM Bulletin.

The EUIPO will not issue any registration certificate for IRs.

### 3.10 Second republication

Articles [189\(2\) and \(3\)](#) and [190\(2\)](#), and [Article 203 EUTMR](#)

The second republication by the EUIPO will take place when, upon conclusion of all procedures, the IR is (at least in part) protected in the EU.

The date of the second republication will be the starting point for the 5-year use period and the date from which the registration may be invoked against an infringer.

From the date of second republication, the IR has the same effects as a registered EUTM. These effects may therefore come into force before the 18-month time limit has elapsed.

Only the following data will be published in Part M.3.1 of the EUTM Bulletin:

111 - number of the international registration;

460 - date of publication in the Gazette, if applicable;

400 - date(s), number(s) and page(s) of previous publication(s) in the EUTM Bulletin;

450 - date of publication of the international registration or subsequent designation in the EUTM Bulletin.

### 3.11 Transfer of the designation of the EU

[Article 201 EUTMR](#)

The IR represents a single registration for administrative purposes since it is one entry in the International Register. However, in practice, it is a bundle of national (regional) marks with regard to substantive effects and the trade mark as an object of property. As regards the link with the basic mark, while the IR must originally be in the name of the proprietor of the basic mark, it may thereafter be transferred independently of the basic mark.

In fact, a 'transfer of the international registration' is nothing more than a transfer of the mark with effect for one, several or all designated Contracting Parties, and for all or some of the goods and services. In other words, it is equivalent to a transfer of the corresponding number of national (regional) marks.

Transfers may not be submitted directly to the EUIPO in its capacity as designated office. They must be submitted to WIPO or through the office of the Contracting Party of the holder using the WIPO form MM5. Once recorded by WIPO, the change of ownership of the designation of the EU will be notified to the EUIPO and automatically integrated into the EUIPO database.

In its capacity as designated office, the EUIPO has nothing to examine in relation to the transfer. Rule 27(4) of the Regulations under the Protocol allows a designated office to declare to WIPO that, as far as its designation is concerned, a change of ownership has no effect. However, the EUIPO does not apply this provision since it does not have the authority to re-examine whether the change in the International Register was based on proof of the transfer.

### 3.12 Invalidity, revocation and counterclaims

Articles [58 to 60](#), Articles [189\(2\)](#) and [190\(2\)](#), and Articles [198](#) and [203](#) EUTMR

[Article 34 EUTMIR](#)

The effects of an IR designating the EU may be declared invalid. The application for invalidation of the effects of an IR designating the EU corresponds to an application for revocation or for declaration of invalidity in EUTM terminology.

There is no time limit for filing an application for revocation/declaration of invalidity, with the following exceptions.

- An application for declaration of invalidity of an IR designating the EU is only admissible once the designation has been finally accepted by the EUIPO, namely once the statement of grant of protection has been sent.



- an application for revocation on the basis of non-use of an IR designating the EU is only admissible if, at the date of filing the application, the final acceptance of the IR had been republished by the EUIPO at least 5 years earlier (see [Article 203 EUTMR](#), stating that the date of publication pursuant to [Article 190\(2\) EUTMR](#) takes the place of the date of registration for the purpose of establishing the date as from which the mark that is the subject of an IR designating the EU must be put to genuine use in the European Union).

The EUIPO will examine the request as if it were directed against a direct EUTM (see the Guidelines, [Part D, Cancellation](#)).

If the IR designating the EU is totally or partially invalidated/revoked further to a final decision or a counterclaim action, the EUIPO will notify WIPO according to Article 5(6) MP and Rule 19 of the Regulations under the Protocol. WIPO will record the invalidation/revocation and publish it in the Gazette.

## 4 Conversion, Transformation, Replacement

### 4.1 Preliminary remarks

Conversion or transformation

Both apply when an IR designating the EU ceases to have effect, but for different reasons.

- When the IR designating the EU is finally refused by the EUIPO or ceases to have effect for reasons independent of the basic trade mark, only **conversion** is available. Conversion is possible within the prescribed time limit even if, in the meanwhile, the IR has also been cancelled from the International Register at the request of the office of origin, that is, via a ‘central attack’.
- When an IR ceases to have effect because the basic mark has been the subject of a ‘central attack’ during the 5-year dependency period, transformation into a direct EUTM application is possible. Transformation is not available when the IR has been cancelled at the holder’s request or the holder has renounced in part or in whole the designation of the EU. The EU designation must still be effective when the transformation is requested, that is, it must not have been finally refused by the EUIPO; otherwise, there will be nothing left to transform, and conversion of the designation would be the only possibility.

## 4.2 Conversion

Articles [139 to 141](#) and [202](#) EUTMR

Rule 24(2)(a)(iii) of the Regulations under the Protocol

The legal option of conversion <sup>90</sup> has its origins in the EUTM system, which has been adapted to allow a designation of the EU through an IR to be converted into a national trade mark application, just like for a direct EUTM. The EUTM system and Madrid System have also been adapted to allow for conversion into a designation of Member States party to the Madrid System (known as ‘opting back’). Malta is not party to the Madrid System.

In the latter case, a request for subsequent designation of the Member State(s) is forwarded to WIPO. This type of subsequent designation is the only one that, instead of being filed with the office of origin or with WIPO directly, has to be filed through the designated office.

For full details on conversion, see the Guidelines, [Part E, Register Operations, Section 2, Conversion](#).

## 4.3 Transformation

[Article 111\(2\)\(p\)](#) and [Article 204 EUTMR](#)

[Article 36 EUTMIR](#)

Article 6(3) and Article 9*quinquies* MP

### 4.3.1 Preliminary remarks

Transformation has its origins solely in the MP. It was introduced in order to soften the consequences of the 5-year dependency period already set in place by the Madrid Agreement. Where an IR is cancelled in whole or in part because the basic mark has ceased to have effect, and the holder files an application for the same mark and same goods and services as the cancelled registration with the office of any Contracting Party for which the IR had effect, that application will be treated as if it had been filed on the date of the IR or, where the Contracting Parties had been designated subsequently, on the date of the subsequent designation. It will also enjoy the same priority, if any.

<sup>90</sup> In English, ‘conversion’ is used to describe a specific legal provision of the EUTM system ([Article 139 et seq. EUTMR](#)) while ‘transformation’ is used to describe that in Article 9 *quinquies* MP. In other languages, only one word is used to describe these two different legal provisions (e.g. in Spanish ‘transformación’). In order to avoid confusion, the English word ‘conversion’ could be used in parentheses when, for example, the Spanish word ‘transformación’ is used within the meaning of [Article 139 EUTMR](#).

This filing is not governed by the MP, nor is WIPO involved in any way. Unlike conversion, transformation of the EU designation into national applications is not possible. Nor is it possible to transform an EU designation into individual Member State designations. If the EU has been designated, the IR has effect in the EU and not in individual Member States as such.

The EU designation must still be effective when the transformation is requested, that is, it must not have been finally refused by the EUIPO; otherwise, there will be nothing left to transform, and conversion of the designation would be the only possibility.

### 4.3.2 Principle and effects

#### [Article 32 EUTMR](#)

Following a **cancellation in whole or in part of an IR designating the EU at the request of the office of origin** under Article 9*quinquies* MP (i.e. following a ‘central attack’ during the 5-year dependency period), the holder may file a ‘direct’ EUTM application for the same mark and for the same goods and services as the cancelled mark.

The application resulting from the transformation will be treated by the EUIPO as if it had been filed on the date of the original IR or, where the EU was designated subsequently to the IR, on the date of the subsequent designation. It will also enjoy the same priority, if any.

**The date of the IR or of the subsequent designation will not become the filing date of the European Union trade mark application.** [Article 32 EUTMR](#), which applies *mutatis mutandis*, lays down clear conditions for the granting of a filing date, subject also to payment of the application fee within 1 month. However, the date of the IR or subsequent designation will be the date that determines the ‘earlier right effect’ of the EUTM for the purposes of priority searches, oppositions, etc.

Unlike for priority and seniority claims ([Article 41\(8\) EUTMR](#)), it is not possible to have a ‘split’ or ‘partial’ date, with one date being only for those goods that were contained in the IR and the filing date of the European Union trade mark application being the relevant date for the additional goods and services. No such partial transformation effect is contemplated in Article 9*quinquies* of the MP or [Article 204 EUTMR](#).

Renewal starts to run from the filing date of the transformed EUTM.

### 4.3.3 Procedure

The conditions for invoking a transformation right under Article 9*quinquies* MP are that:

- the application is filed within a period of 3 months from the date on which the IR was cancelled in whole or in part, and

- the goods and services of the ensuing application are in fact covered by the list of goods and services of the designation of the EU.

The Office will refuse any EUTM application resulting from an IR transformation filed prematurely, that is to say, before the cancellation of the IR is recorded by WIPO.

The applicant needs to claim this right in the relevant section provided in the EUTM application form. The following indications must be given:

1. number of the IR that has been cancelled in whole or in part;
2. date on which the IR was cancelled in whole or in part by WIPO;
3. date of the IR pursuant to Article 3(4) MP or date of territorial extension to the EU made subsequently to the IR, pursuant to Article 3ter(2) MP;
4. date of priority claimed in the IR, if any.

The Office will invite the applicant to remedy any deficiencies detected within a period of 2 months.

If the deficiencies are not remedied, the right to the date of the IR or the territorial extension and, if any, of the priority of the IR will be lost. In other words, if the transformation is finally refused, the EUTM application will be examined as a 'normal' application.

#### **4.3.4 Examination**

##### **4.3.4.1 Application for transformation of an IR designating the EU where no particulars have been published**

When the application for transformation relates to an IR designating the EU for which the particulars have not been published pursuant to [Article 190\(2\) EUTMR](#) (in other words, that has not been finally accepted by the EUIPO), the EUTM resulting from transformation will be treated as a normal EUTM application; it will be examined as to classification, formalities and absolute grounds and published for opposition purposes. Nothing in the regulations allows the EUIPO to omit the examination process.

Nevertheless, since this case presupposes that an IR designating the EU had already existed, the EUIPO can take advantage of the classification of the list of goods and services of the cancelled IR (as far as it complies with the EUIPO rules).

The EUTM will be published in Part A of the EUTM Bulletin for opposition purposes, with an additional field under INID code 646 mentioning the details of the transformation. The remainder of the procedure will be the same as for a normal EUTM filing, including if an opposition procedure had already been initiated against the IR designating the EU without reaching the final decision stage. In such a case, the previous opposition procedure would be closed and a new opposition would need to be filed.

#### 4.3.4.2 Application for transformation of an IR designating the EU where particulars have been published

When the application for transformation relates to an IR designating the EU for which the particulars have already been published pursuant to [Article 190\(2\) EUTMR](#), the examination and opposition stage are omitted (Articles [42 to 47 EUTMR](#)).

Nevertheless, the list of goods and services will have to be translated into all languages. The EUTM will then be published in Part B.2 of the EUTM Bulletin with the translations and the additional INID code 646, and the registration certificate will be issued immediately.

According to [Article 204\(2\) EUTMR](#), in the event of the transformation of an IR after second republication, the full rights emanating from the IR designating the EU will continue to apply without interruption to the registered EUTM, meaning that the latter will, for the purposes of the determination of an 'earlier mark' within the meaning of Articles [8](#) and [9 EUTMR](#), benefit from the filing (or priority) date of the IR or the subsequent designation.

According to [Article 182 EUTMR](#), unless there are specific provisions to the contrary, the provisions of the EUTMR and the acts adopted pursuant to it apply *mutatis mutandis* to IRs designating the EU. This includes, inter alia, [Article 18\(1\) EUTMR](#), which imposes on EUTM proprietors the obligation to use the mark within a period of 5 years following registration. According to [Article 203 EUTMR](#), the date of the second republication of an IR designating the EU is the date taken for calculating its grace period. The reasoning behind the 5-year grace period is to give the trade mark proprietor 5 years from registration to prepare use of the mark. Since the situation of an IR designating the EU that has been transformed into an EUTM registration after its second republication is no different from that of an EUTM registration filed directly with the EUIPO, there is no reason for any different treatment either.

Furthermore, from the point of view of equity, a trade mark owner that enjoys the full rights of trade mark protection without interruption is also under the corresponding obligations as set out by the law, including inter alia the obligation to use the trade mark concerned.

Consequently, the transformation of an IR designating the EU after the second republication has no impact on the calculation of the grace period, which commences as provided for in [Article 203 EUTMR](#) with the second republication, namely on the date of the second republication of the original EU designation in part M.3 of the EUTM Bulletin.

#### 4.3.5 Transformation and seniority

If seniority claims have been accepted by the EUIPO and are registered by WIPO in the file for the transformed IR designating the EU, there is no need to claim seniority again in the EUTM resulting from transformation. This is not explicitly set out in

[Article 36 EUTMIR](#) (only priority is mentioned under (d)) but is extended by analogy to seniority in view of the fact that:

- the EUIPO has already accepted the claims and WIPO has published them;
- if the owner had let the earlier marks lapse in the meanwhile, it would not be able to file new claims before the EUIPO (one condition of a valid seniority claim being that the earlier right is both registered and in force when the claim is made).

### 4.3.6 Fees

There is no specific 'transformation' fee. The EUTM application resulting from the transformation of the IR designating the EU is subject to the same fees as any EUTM application.

The basic fee for the EUTM application must be paid to the EUIPO within 1 month of the filing of the EUTM requesting transformation in order for the request to comply with [Article 32 EUTMR](#) and Article 9*quinquies*(iii) MP and for the transformation to be accepted. For example, if the end of the 3-month time limit for transformation is 01/04/2012 and transformation into an EUTM application is filed on 30/03/2012, the deadline for payment of the basic fee is 30/04/2012. If payment occurs after that date, the conditions for transformation are not met, the transformation right will be lost and the filing date given to the EUTM application will be the date of the payment.

## 4.4 Replacement

[Article 111\(3\)\(t\)](#) and [Article 197 EUTMR](#)

Article 4*bis* MP

Rule 21 of the Regulations under the Protocol

### 4.4.1 Preliminary remarks

Replacement has its origins in the Madrid Agreement and Madrid Protocol. A mark that is registered with the office of a Contracting Party is, under certain conditions, considered to be replaced by an international registration of the same mark without prejudice to the rights already acquired (earlier date). The wording of Article 4*bis*(1) MP clearly provides that replacement is considered to take place automatically, without the need for any action by the holder and without any record having to be made of the replacement. Nevertheless, it is possible to request the EUIPO to take note of the replacement in its Register (Rule 21 of the Regulations under the Protocol). The purpose of this procedure is to ensure that the relevant information concerning the replacement is made available to third parties in the national or regional registers as

well as in the International Register. In other words, it is not an obligation to have the replacement registered in order to be able to invoke it, but it can be useful.

Apart from the qualification relating to earlier acquired rights, neither the Madrid Agreement nor the Madrid Protocol elaborates further on replacement.

#### **4.4.2 Principle and effects**

In accordance with Article 4*bis* MP, the holder may request the EUIPO to take note in its Register of the international registration that replaces an EUTM. The holder's rights in the EU should be considered to start from the filing date of the earlier EUTM registration. An entry will therefore be made in the EUTM Register to the effect that a direct EUTM has been replaced by a designation of the EU through an IR, and published.

#### **4.4.3 Procedure**

A request for replacement may be filed at the EUIPO by the international holder at any time after notification of the EU designation by WIPO.

Once a request to record a replacement has been received, the EUIPO will carry out a formal examination, checking that the marks are identical, that all the goods and services listed in the EUTM are listed in the IR designating the EU, that the parties are identical and that the EUTM has been registered prior to the designation of the EU. The IR need not have an identical list of goods and services. The list may be broader in scope but it cannot be narrower. If the list is narrower, a deficiency will be issued. This deficiency can normally be overcome by partially surrendering the goods and services of the EUTM that fall outside the scope of the IR.

The EUIPO considers it sufficient for noting the replacement in the Register if the IR and EUTM coexist on the date of the IR. In particular, should the designation of the EU through an IR not yet be finally accepted, the EUIPO will not wait for final acceptance before recording the replacement. It is up to the international holder to decide when to request the replacement.

If all conditions are met, the EUIPO will note the replacement in the EUTM Register and inform WIPO that an EUTM has been replaced by an IR in accordance with Rule 21 of the Regulations under the Protocol, indicating:

- the number of the IR;
- the EUTM number;
- the EUTM application date;
- the EUTM registration date;
- the priority date(s), if relevant;
- the seniority number(s), filing date(s) and country/countries, if relevant;
- the list of goods and services of the replacement, if relevant.

After the replacement has been recorded, the EUTM is maintained normally in the Register as long as the holder renews it. In other words, there is coexistence between the replaced EUTM in force and the IR designating the EU.

According to Rule 21(2) of the Regulations under the Protocol, WIPO will record the indications notified under paragraph (1) of that Rule in the International Register, publish them and inform the holder accordingly, in order to ensure that the relevant information concerning replacement is made available to third parties. Nevertheless, there is no obligation for the EUIPO to communicate further changes affecting the replaced EUTM.

#### **4.4.4 Fees**

The request for taking note of a replacement is free of charge.

#### **4.4.5 Publication**

[Article 111\(3\)\(t\)](#) and [Article 116 EUTMR](#)

The replacement is entered in the EUTM Register and published in the EUTM Bulletin under Part C.3.7.

#### **4.4.6 Replacement and seniority**

Article 4*bis*(1) MP

Since replacement occurs ‘without prejudice to any rights acquired’ by virtue of the earlier registration, the EUIPO will include information on the seniority claims contained in the replaced EUTM registration within the content of the notification to be sent to WIPO under Rule 21 of the Regulations under the Protocol.

#### **4.4.7 Replacement and transformation**

If an IR that replaces a direct EUTM ceases to have effect following a ‘central attack’, and provided that the conditions laid down by Article 9*quinquies* MP are met, the holder can request transformation of the IR under Article 9*quinquies* MP while maintaining the effects of the replacement of the EUTM and its earlier date effects, including priority or seniority if applicable.



#### 4.4.8 Replacement and conversion

The IR and the EUTM should coexist on the date of the IR if the replacement is to be effective. Therefore, if the IR that replaces the direct EUTM is finally refused by the EUIPO (e.g. further to an opposition), the holder can request conversion of the designation of the EU and should be able to maintain the effects of the replacement of the EUTM and its earlier date effects, including priority or seniority if applicable.

## 5 Division

Articles [50](#) and [56](#) EUTMR

Articles [8](#) and [11](#) EUTMIR

Rule *27bis* of the Regulations under the Protocol

### 5.1 Preliminary remarks

In October 2016 the Madrid Union Assembly adopted amendments to the Regulations under the Protocol, including the introduction with effect from **1 February 2019** of a new Rule *27bis* on the division of IRs. As from that date, IR holders have had the same option of dividing their marks as EUTM proprietors.

The divisional IR keeps the designation date and any priority date of the original IR. If seniority claims have been accepted by the EUIPO and are registered by WIPO in the original IR, there is no need to claim seniority again in the divisional IR.

### 5.2 Procedure

The request must be submitted to the EUIPO using WIPO official form MM22 in the language of the IR.

All relevant fields of MM22 must be filled in:

- the name of the Contracting Party of the Office presenting the request;
- the name of the Office presenting the request;
- the number of the international registration;
- the name of the holder;
- the names of the goods and services to be set apart, grouped in the appropriate classes of the International Classification of Goods and Services;
- the method of payment of the international fee, or instructions to debit the required amount from an account opened with the International Bureau, and the identity of the party effecting the payment or giving the instructions.

**In addition**, the list of goods and services to remain in the original registration must be indicated on an additional page.

The EUIPO will check that the request contains all these elements and examine whether the request complies with the requirements of Articles [50](#) and [56](#) EUTMR and Articles [8](#) and [11](#) EUTMIR.

For full details on division, see the Guidelines, [Part B, Examination, Section 1, Proceedings, Paragraph 5.4, Division of an EUTM application](#).

Once satisfied that the request is complete and complies with the relevant Regulations, the EUIPO forwards it to WIPO. If the request fulfils the requirements of Rule 27bis of the Regulations under the Protocol, and once the international fee has been paid, WIPO will record the division, create the divisional IR in the International Register and notify the EUIPO accordingly.

The EUIPO will then create the divisional IR.

### **5.3 Fees**

The EUIPO will not charge any fee for examining requests for division of IRs.

However, requests are subject to an international fee of CHF 177, to be paid directly to WIPO. Any such fee paid by error to the EUIPO will be reimbursed.



---

***GUIDELINES FOR EXAMINATION OF  
REGISTERED COMMUNITY DESIGNS***

***EUROPEAN UNION  
INTELLECTUAL PROPERTY OFFICE  
(EUIPO)***

***Examination of applications for registered  
Community designs***



# 1 Introduction

## 1.1 Purpose of the Guidelines

The Guidelines explain how, in practice, the provisions of the Community Design Regulation <sup>(1)</sup> (CDR), the Community Design Implementing Regulation <sup>(2)</sup> (CDIR), and the Fees Regulation <sup>(3)</sup> (CDFR) are applied by the Office's Operations Department from receipt of an application for a registered Community design (RCD) up to its registration and publication.

The Office has no competence with regard to **unregistered** Community designs.

The purpose of the Guidelines is to ensure consistency among the decisions taken by the Operations Department and to ensure a coherent practice in file handling. These Guidelines are merely a set of consolidated rules setting out the line of conduct that the Office itself proposes to adopt, which means that, to the extent that those rules comply with the legal provisions of a higher authority, they constitute a self-imposed restriction on the Office, in that it must comply with the rules that it has itself laid down. However, these Guidelines cannot derogate from the CDR, the CDIR or the CDFR, and it is solely in the light of those regulations that they should be interpreted and applied.

The Guidelines are structured to follow the sequence of the examination process, with each section and subsection constituting a step in the registration proceedings from receipt of the application up to registration and publication. The general principles (see [paragraph 1.2](#) below) should be kept in mind throughout the whole examination process (see the Guidelines, [Part A, General Rules, Section 2, General Principles to be Respected in the Proceedings](#)).

## 1.2 General principles

---

1 [Council Regulation \(EC\) No 6/2002 of 12 December 2001 on Community Designs](#) amended by Council Regulation No 1891/2006 of 18 December 2006 amending Regulations (EC) No 6/2002 and (EC) No 40/94 to give effect to the accession of the European Community to the Geneva Act of the Hague Agreement concerning the international registration of industrial designs.

2 [Commission Regulation \(EC\) No 2245/2002 of 21 October 2002 implementing Council Regulation \(EC\) No 6/2002 on Community Designs](#) amended by Commission Regulation (EC) No 876/2007 on 24 July 2007 amending Regulation (EC) No 2245/2002 implementing Council Regulation (EC) No 6/2002 on Community designs following the accession of the European Community to the Geneva Act of the Hague Agreement concerning the international registration of industrial designs.

3 [Commission Regulation \(EC\) No 2246/2002 of 16 December 2002 on the fees payable to the Office for Harmonization in the Internal Market \(Trade Marks and Designs\) in respect of the registration of Community designs](#) amended by Commission Regulation (EC) No 877/2007 of 24 July 2007 amending Regulation (EC) No 2246/2002 concerning the fees payable to the Office for Harmonization in the Internal Market (Trade Marks and Designs) following the accession of the European Community to the Geneva Act of the Hague Agreement concerning the international registration of industrial designs.

### 1.2.1 Duty to state reasons

The decisions of the Office must state the reasons on which they are based (Article 62 CDR). The reasoning must be logical and it must not lead to internal inconsistencies.

The Office will apply the principles as explained in the Guidelines, [Part A, General Rules, Section 2, General Principles to be Respected in the Proceedings, paragraph 1, Adequate reasoning.](#)

### 1.2.2 Right to be heard

The decisions of the Office will be based only on reasons or evidence on which the applicant has had an opportunity to present its comments (Article 62 CDR, second sentence).

The Office will apply the principles as explained in the Guidelines, [Part A, General Rules, Section 2, General Principles to be Respected in the Proceedings, paragraph 2, The right to be heard.](#)

### 1.2.3 Compliance with time limits

Applicants must respond to the Office's communications within the time limits set by those communications.

The Office will apply the principles explained in the Guidelines, [Part A, General Rules, Section 1, Means of Communication, Time Limits.](#)

Any written submission or document that has not been received within the time limits set by the Office is late. The same applies to supplementary materials attached only to the confirmation copy of a letter that was itself sent on time, where this confirmation mail arrives after the expiry of the time limit. This is irrespective of whether such materials are specifically mentioned in the initial letter.

The Office may disregard facts or evidence that the applicant does not submit in due time (Article 63(2) CDR).

For calculation of time limits see Article 56 CDIR.

An applicant's request to extend a time limit has to be made before expiry of that time limit (Article 57(1) CDIR).

As a general rule, a first request to extend a time limit will be granted. Further extensions will not be granted automatically. Reasons in support of any further request for extension must be submitted to the Office. The request for extension of the time limit must indicate the reasons why the **applicant** cannot meet the deadline. Obstacles faced by the parties' **representatives** do not justify an extension (05/03/2009, [C-90/08 P](#), *Corpo livre*, EU:C:2009:135, § 20-23).

The extension cannot result in a time limit longer than 6 months (Article 57(1) CDR). The applicant is informed about any decision as to the extension.

Applicants failing to observe the time limits run the risk that their observations may be disregarded, which may result in a loss of rights. In such a case, the applicant may file a request for *restitutio in integrum* (Article 67 CDR; see also the Guidelines, [Part A, General Rules, Section 8, Restitutio in Integrum](#)). However, applicants are reminded that, unlike in the case of European Union trade marks, the CDR does not provide for the possibility of requesting a continuation of proceedings.

#### **1.2.4 Scope of the examination carried out by the Office**

When examining an application for a Community design, the Office will examine the facts of its own motion (Article 63(1) CDR).

The examination procedure is kept to a minimum, that is, mainly an examination of the formalities. However, the following grounds for non-registrability set out in Article 47 CDR must be examined *ex officio* by the Office:

1. whether the subject matter of the application corresponds to the definition of a design as set forth in Article 3(a) CDR; and
2. whether the design is contrary to public policy or accepted principles of morality.

Where one of these two grounds is applicable, the procedure explained below in [paragraph 4](#) will apply.

Other protection requirements are not examined by the Office. A Community design that has been registered in breach of the protection requirements referred to in Articles [3 to 9](#) CDR is liable to be invalidated if an interested party files a request for a declaration of invalidity (Article 25(1) CDR) (see the Guidelines, [Examination of Design Invalidity Applications](#)).

#### **1.2.5 User-friendliness**

One of the fundamental objectives of the CDR is that the registration of Community designs should present the minimum cost and difficulty to applicants, so as to make it readily available to any applicant, including small and medium-sized enterprises and individual designers.

To that end, examiners are encouraged to contact the applicant or, if a representative has been appointed (see [paragraph 2.5](#) below), its representative, by telephone, to clarify issues arising from the examination of an application for a Community design, either before or after an official deficiency letter is sent.



## 2 Filing an Application with the Office

### 2.1 Introduction

There are two ways of applying for registration of a Community design, that is, (i) either via a direct filing, with the Office or with the central industrial property office of a Member State or, in Benelux countries, with the Benelux Office for Intellectual Property (BOIP) (Article 35 et seq. CDR) or (ii) via an international registration filed with the International Bureau of the World Intellectual Property Organization and designating the European Union (Article 106a et seq. CDR).

This section will deal with direct filings. The examination of the formalities relating to international registrations designating the European Union will be explained in [paragraph 12](#) below.

### 2.2 Form of the application

#### 2.2.1 Different means of filing

An application for a registered Community design may be filed directly with the Office by e-filing, post or personal delivery. It may also be filed at the central industrial property office of a Member State or, in Benelux countries, at the BOIP (Article 35 CDR).

E-filing is the strongly recommended means of filing since it can guarantee accurate quality of the design representation, and the system gives guidance to the applicant, thus reducing the number of potential deficiencies and speeding up the examination procedure.

For filings other than e-filing, use of the form provided by the Office (Article 68(1)(a) CDIR) is not mandatory but is recommended (Article 68(6) CDIR) in order to facilitate the processing of the application and avoid errors.

Fax is expressly identified as a means of communication in all procedures relating to Community designs in Article 47(2)(d) CDIR and Article 51 CDIR, however pursuant to Article 2 of [Decision No EX-20-9](#) of the Executive Director of the Office of 3 November 2020 on communication by electronic means, due to technical limitations and malfunctions affecting the reliability and uninterrupted functioning of communications by fax that lie beyond the Office's control, **fax can no longer be offered and will no longer be used**, as a means of communication in procedures before the Office.

To facilitate resubmission in the event of a malfunction during the electronic transmission of an application, communication or other document through the specific

e-operation or e-filing in the User Area, the Office will make two electronic back-up alternatives available:

1. an upload solution located in the Communications section of the User Area; this is a general upload platform that allows documents to be attached and sent to the Office;
2. a file-sharing solution outside the User Area; the Office will provide the account holder with access to a secure file-sharing location where the document(s) in question can be uploaded.

Technical details on the accessibility and functionality of both back-up alternatives are available in the [Conditions of Use of the User Area](#).

## **2.2.2 E-filing**

A registered Community design can be filed via the Office's website (<https://euiipo.europa.eu/ohimportal/en/rcd-apply-now>), which also allows for the accelerated procedure (Fast Track) (see [paragraph 2.7.1](#) below).

Where a communication is sent to the Office by electronic means, the indication of the sender's name will be deemed to be equivalent to the signature (see [paragraph 6.1.3](#) below).

## **2.2.3 Applications sent by post or personal delivery**

Applications can be sent by ordinary post or private delivery service to the Office at the following address:

European Union Intellectual Property Office  
Avenida de Europa, 4  
03008 Alicante  
SPAIN

Applications can also be handed in personally at the Office's reception. See Decision [No EX-18-5](#) of the Executive Director of the Office of 3 September 2018 concerning the hours the Office is open to receive submissions by personal delivery relating to registered Community designs, for further information.

## **2.3 Content of the application**

### **2.3.1 Minimum requirements**

The application must satisfy all the mandatory requirements set out in Articles 1 (Content of the application), 3 (Classification and indication of products), 4 (Representation of the design) and 6 (Fees for the application) CDIR.

The application must be signed by the applicant. The name of the signatory must be indicated and the authority of the signatory must be specified (see [paragraph 6.1.3](#) below).

### 2.3.2 Additional requirements

Additional requirements apply where the applicant selects one of the following options: a multiple application is filed (Article 2 CDIR), specimens are filed (Article 5 CDIR), a priority or an exhibition priority is claimed (Articles 8 and 9 CDIR), or where the applicant chooses to be, or must be, represented (Article 77 CDR).

### 2.3.3 WIPO DAS

As of 11/07/2020, the Office is a participating office in the World Intellectual Property Organization Digital Access Service (WIPO DAS), which is an electronic system allowing priority documents and similar documents to be securely exchanged between participating IP offices.

The system enables applicants and offices to meet the requirements of the Paris Convention for the certification of priority documents, allowing them to be exchanged in an electronic environment.

Using the EUIPO as **Office of First Filing**, when filing their application electronically (see [paragraph 2.2.2](#) above) applicants may request that their application be registered in the WIPO DAS system. The Office will register the application in WIPO DAS by providing the mandatory data elements in the registration request, including:

- IP type,
- priority office code,
- priority application number,
- priority application filing date,
- access code.

By checking the box to request the inclusion of the application in WIPO DAS, the applicant will automatically receive the access code, which they can then cite when claiming priority from the application in subsequent filings before other offices party to the WIPO DAS system.

## 2.4 Language of the application

The application may be filed in any of the official languages of the European Union (language of filing, or first language) (Article 98(1) CDR; Article 1(1)(h) CDIR).

In addition to the language of filing, the applicant must indicate a second language, which must be a language of the Office, that is to say, English (EN), French (FR), German (DE), Italian (IT) or Spanish (ES). The second language must be different from

the language of filing. The second language serves as a potential language for invalidity proceedings. The choice of first and second language cannot be changed once filed.

If the language that the applicant has selected as the first language is one of the five languages of the Office, then this will be used as the correspondence language.

Only where the language selected as the first language is not one of the five Office languages can the applicant indicate that they want the correspondence language to be the second language. This request can be made on the application form by ticking the relevant box or can be requested later, either by explicit request, or implicitly by sending a communication to the Office in the second language.

This language regime applies throughout the application procedure until registration.

As the choice of languages also affects the determination of the language in invalidity proceedings after the registration, applicants are advised to note that the language regime for designs is not identical to the language regime for the European Union trade mark (see the Guidelines on [Examination of Design Invalidity Applications for more information on the language regime in invalidity proceedings, paragraph 3.3](#)).

## **2.5 Representatives**

Where the applicant does not have its domicile or its principal place of business or a real and effective industrial or commercial establishment within the European Economic Area (EEA), it must be represented by a representative in all proceedings before the Office other than in filing an application.

The representative has to be indicated in the application. If this requirement is not complied with, the applicant will be requested to appoint a representative within a time limit of 2 months. Where the applicant does not comply with the request, the application is rejected as inadmissible (Article 77(2) CDR; Article 10(3)(a) CDIR).

For more information on representation, please refer to the Guidelines, [Part A, General Rules, Section 5, Parties to the proceedings and professional representation](#).

## **2.6 Date of receipt, file number and issue of receipt**

### **2.6.1 Applications filed through national offices (intellectual property office of a Member State or Benelux Office for Intellectual Property (BOIP))**

If a Community design application is filed at the central industrial property office of a Member State or at the BOIP, it will have the same effect as if it had been filed with the Office on the same day, provided that it is received by the Office within 2 months of the

date it was filed at the national office or, as the case may be, the BOIP (Article 38(1) CDR).

If the Community design application does not reach the Office within this 2-month time limit, it will be deemed to have been filed on the date that it is received by the Office (Article 38(2) CDR).

Where the Community design application is received shortly after the expiry of this 2-month period, the examiner will check *ex officio* whether this time limit is to be extended under one of the conditions provided for in Article 58(4) CDIR. This may have to be assumed due to exceptional occurrences (e.g. natural disasters, strikes, pandemics) interrupting the proper functioning of the Office or, as the case may be, of the respective national offices / the BOIP.

## 2.6.2 Applications received directly by the Office

The date of receipt is the date on which the application reaches the Office. This date may not coincide with the 'date of filing' where the requirements for such a date to be allocated are not met (see [paragraph 3](#) below).

For Community design applications filed through the Office's User Area (e-filing), the system immediately issues an automatic electronic filing receipt, which contains the date of receipt and the file number. The applicant should keep this receipt.

Where the application is sent by post personal delivery, the applicant will not receive the confirmation of receipt or file number until the Office issues its first communication (see [paragraph 2.7](#) below).

For further information on communications to the Office, see the Guidelines, [Part A, General Rules, Section 1, Means of Communication, Time Limits](#).

## 2.7 Registration or examination report

### 2.7.1 Registration

If the application for a Community design satisfies all requirements for registration, it will normally be registered within **10 working days**.

However, even though an application complies with all requirements, it may be delayed if the products in which the design is intended to be incorporated, or to which it is intended to be applied, were not indicated by reference to the list of products included in DesignClass (see [paragraph 6.1.4.2](#)), the product indication database on the Office's website. In such a case, the indication of the products may have to be sent for translation into the official languages of the European Union (see [paragraph 6.1.4.4](#) below).

An application complying with all registration requirements can be registered within **two working days** if the following conditions for the accelerated procedure (Fast Track) are met (for possible modifications of these conditions please consult the Office's website):

- the application is filed electronically (e-filing) using the four-step form;
- both the indication of product(s) and its/their classification are made using DesignClass (see [paragraph 6.1.4.4](#) below);
- priority documents, where a priority is claimed, are already available in WIPO DAS and are identified by a WIPO DAS code, or included with the e-filing application (not required when the earlier filing is with the Office);
- no exhibition priority is claimed;
- the representative, if any, is registered in the Office's database and indicates the respective identification number in the form;
- fees are to be debited from a current account with the Office or paid by credit card.

## **2.7.2 Examination report and informal communication on possible deficiencies (preliminary examination report)**

Where a deficiency has been detected in the application, the examiner will issue an examination report summarising the irregularities noted and giving a time limit for the applicant to remedy them.

Before sending such an examination report, the examiner can send an informal communication, called a 'preliminary examination report', highlighting some potential deficiencies and aimed at speeding up the examination procedure. This informal communication informs the applicant that the examination procedure is pending due to any of the following circumstances.

### **2.7.2.1 Priority claims and supporting documents**

As of 12/09/2020, the Office is a participating office in WIPO DAS, which is an electronic system allowing priority documents and similar documents to be securely exchanged between participating IP offices.

The system enables applicants and offices to meet the requirements of the Paris Convention for the certification of priority documents, allowing them to be exchanged in an electronic environment.

Where the application claims the priority of one or more previous applications registered in WIPO DAS, the applicant must provide the relevant details, namely, the file number, filing date and country of the previous application together with the WIPO DAS access code in the pertinent fields in the application form or within 3 months of either the filing date or the priority claim, as the case may be, in order for the Office to access and download those priority documents, as **Office of Second Filing**.

Where the application claims the priority of one or more previous applications that are not available in WIPO DAS by providing relevant details but without submitting a copy thereof, or claims priority from an exhibition without submitting a certificate thereof, the

applicant may still submit a copy of the previous application within 3 months of the filing date (Articles 42 and 44 CDR; Articles 8(1) and 9(1) CDIR; see [paragraph 6.2.1.1](#) below).

In such circumstances, the examiner will inform the applicant that examination of the application will be put on hold until the missing copy of the previous application(s) or exhibition certificate is submitted. Examination will proceed **3 months** after the filing date, unless a copy of the previous application(s) or exhibition certificate (see [paragraph 6.2.1.2](#) below), or a declaration that the priority claim is withdrawn, is received earlier.

#### 2.7.2.2 Priority claims made subsequent to filing

The priority of one or more previous applications or of an exhibition may still be claimed within 1 month of the filing date, by submitting the declaration of priority, stating the file number, date and country of the previous application (Article 42 CDR; Article 8(2) CDIR; see [paragraph 6.2.1.1](#) below), or the name of the exhibition and the date of first disclosure of the product (Article 44 CDR; Article 9(2) CDIR; see [paragraph 6.2.1.2](#) below), and by providing the WIPO DAS access code where available ([Decision No EX-20-7](#) of the Executive Director of the EUIPO of 11 September 2020 on the formal requirements of priority claims relating to registered Community designs; see [paragraph 6.2.1.1](#) below).

Where the applicant states in the application its intention to claim such priority, the examiner will inform the applicant that the examination of the application will be put on hold until the missing information is submitted. The examination will proceed **1 month** after the filing date, unless a declaration of priority, or a declaration that the priority claim is withdrawn, is received earlier.

Where the applicant does not state its intention to claim priority, the examination of the application will proceed as normal. Any priority claims received within 1 month of the filing date will be examined upon receipt, even if this is after registration. However, the Office will not issue a new registration certificate including a priority claimed after registration; instead, applicants may obtain an extract from the Register with updated data including the priority (see [paragraph 10.3](#) below).

#### 2.7.2.3 Payment of fees

All necessary fees relating to an application must be paid at the time when the application is submitted to the Office (Article 6 CDIR; see [paragraph 8](#) below).

##### Lack of payment or unidentified payment

Where the application has not yet been linked with a payment of the corresponding fees, the examiner will inform the applicant that the examination will proceed as soon as the payment has been identified and linked to this specific application.

If the applicant does not respond to the Office's communication, and no payment has been made or identified, a deficiency letter will be sent.



### Lack of funds

Where the full amount of the fees relating to the application cannot be debited from the current account due to insufficient funds, the examiner will inform the applicant that the examination will begin as soon as the current account has been credited with the missing amount.

If the applicant does not respond to the Office's communication, and the payment remains incomplete, a deficiency letter will be sent.

The above also applies to credit card payments where the transaction fails due to reasons not attributable to the Office. In such cases, the applicant will have to use another method of payment.

For more information on the payment of fees, see [paragraph 8](#) below.

#### 2.7.2.4 Multiple applications and requests for partial deferment

For filings other than e-filings, where a multiple application contains a request for deferment in respect of **some** designs (see [paragraph 6.2.5](#) below), the examiner will send the applicant a summary of the application containing a representation of the first view of each design to be published without delay. The applicant will be requested to confirm the correctness of this summary within 1 month. In the absence of any reply or contrary instruction from the applicant, the examination will proceed on the basis of the information on file.

## **3 Allocation of a Filing Date**

The date on which a document is 'filed' is the date of receipt by the Office rather than the date on which the document was sent (Article 38(1) CDR and Article 7 CDIR).

Where the application has been filed at the central industrial property office of a Member State or at the BOIP, the date of filing at that office will be deemed the date of receipt by the Office, unless the application reaches the Office more than 2 months after such date. In this case, the date of filing will be the date of receipt of the application by the Office (Article 38 CDR).

Pursuant to Article 36(1) CDR, the allocation of a filing date requires that the application contains at least:

1. a request for registration of a Community design;
2. information identifying the applicant; and
3. a representation of the design suitable for reproduction pursuant to Article 4(1)(d) and (e) CDIR or, where applicable, a specimen (Article 10 CDIR).

If the application does not meet any of these requirements, the Office will notify the applicant of the deficiency, and give the applicant 2 months from receipt of the notification to remedy that deficiency.



If deficiencies are remedied within the time limit set by the Office, the date on which all the deficiencies are remedied will determine the date of filing, unless specified differently below (Article 10(2) CDIR).

If the deficiencies are not remedied within the time limit set by the Office, the application will not be dealt with as a Community design application. The file will be closed by a decision of the examiner and the applicant will be notified. The examiner will notify the Finance Department that a refund of any fees paid should be made to the applicant (Article 10(2) CDIR).

Payment of fees is not a requirement for allocating a filing date. It is, however, a requirement for registration of the application (see [paragraph 8](#) below).

### **3.1 Request for registration**

A request for registration is filed where the applicant has used e-filing, or has completed (at least partly) the application form provided by the Office or has used its own form (see [paragraph 2.2](#) above).

### **3.2 Information identifying the applicant**

For the purpose of allocating a filing date, the information identifying the applicant does not have to satisfy all the requirements set out in Article 1(1)(b) CDIR (see [paragraph 6.1.1](#)). It is enough that the surname and forename(s) of natural persons or the corporate name of legal entities is supplied, along with an address for service or any other data communication link that allows the applicant to be contacted. If the Office has given the applicant an identification number, it is sufficient to mention that number together with the applicant's name. For information on the identification elements of design applicants, including the name, legal form, and address, see the Guidelines, [Part A, General rules, Section 5, Parties to the proceedings and professional representation, paragraph 3, Identification of parties to the proceedings](#).

### **3.3 Representation of the design suitable for reproduction**

#### **3.3.1 General requirements**

The representation of the design must consist of a graphic or photographic reproduction of the design, either in black and white **or** in colour (Article 4(1) CDIR).

Irrespective of the form used for filing the application (e-filing or paper), the design must be reproduced on a **neutral background** and **must not be retouched** with ink or correcting fluid.

It must be of a quality permitting all the details of the matter for which protection is sought to be clearly distinguished and permitting it to be reduced or enlarged to a size no greater than 8 cm by 16 cm per view for entry in the Community Designs Register and for publication in the *Community Designs Bulletin* (Article 4(1)(e) CDIR).

The Court of Justice has held that before the application for registration can obtain a date of filing, it must contain a representation that enables the matter for which protection is sought to be identified. It is not possible to interpret the CDR as allowing an application for registration to be considered validly filed when it does not enable the design for which registration is sought to be clearly identified (05/07/2018, [C-217/17 P](#), Becher, EU:C:2018:534, § 59).

In addition, for applications filed electronically, it must meet the technical requirements of Article 9 of [Decision No EX-20-9](#) of the Executive Director of the Office of 3 November 2020 on communication by electronic means.

Drawings, photographs (except slides), computer-made representations or any other graphical representation are accepted, provided they are suitable for reproduction, including on a registration certificate in paper format. On the basis of the current legislation set out in Article 36(5) CDR and Article 4 CDIR, 3D computer-animated design generating motion simulation can only be considered as an additional technical means of viewing the design and does not replace conventional static views. CD-ROMs and other data carriers are not accepted.

### **3.3.2 Neutral background and elements external to the design**

The background in a view is considered neutral as long as the design shown in this view is clearly distinguishable from its environment without interference from any other object, accessory or decoration, whose inclusion in the representation could cast doubt on the protection sought (16/04/2012, [R 2230/2011-3](#), Webcams, § 11-12).

In other words, the requirement of a neutral background demands neither a 'neutral' colour nor an 'empty' background. Instead, what is decisive is that the design stands out sufficiently clearly from the background to remain identifiable (13/09/2017, [R 1211/2016-3](#), Tavoli, § 61).

The Office and a number of European Union intellectual property offices have agreed on a Common Practice under the European Trade Mark and Designs Network (CP6).

#### **3.3.2.1 Background colours, contrast and shadows**



In accordance with that Common Practice (CP6), the following aspects should be taken into consideration when assessing if a background is neutral: colour, contrast and shadow. The examples given below in relation to these aspects are taken from the Common Practice (CP6), which also lists additional examples.

A single or predominant colour in a background is always acceptable if it stands out against the colours of the design.

Examples of an acceptable single or predominant background colour

<p><b>Austrian lapsed design</b> <b>No 1747/1999</b></p>	<p><b>RCD No 2 333 484-0001</b></p>
	

Examples of an unacceptable single or predominant background colour

<p><b>CP6 example</b></p>	<p><b>CP6 example</b></p>
	

Graduating colour or more than one colour in a background is acceptable provided the design is clearly distinguishable.

Examples of an acceptable graduating colour and more than one colour in a background

<p><b>RCD No 1 387 476-0001</b></p>	<p><b>French design</b> <b>No 955805-0005</b></p>
	



As for contrast, all features of the design should be clearly visible. The contrast is considered insufficient when the background colour and the design are similar and melt partly into each other, with the result that not all parts of the design contrast sufficiently

with the background (i.e. it is not clear where the product finishes and the background starts). Sometimes, a darker background can help when the design is clear or pale and vice versa.

Example of sufficient contrast with background



Examples of insufficient contrast with background

<b>Portuguese lapsed design No 420-0006</b>	<b>CP6 example</b>	<b>Portuguese lapsed design No 00023465-0001</b>
		

Shadows or reflections are acceptable as long as all of the design features remain visible.



Shadows or reflections are unacceptable when the subject of protection of the design, in any of the submitted views, cannot be determined in an unambiguous way. This can occur when there is limited colour contrast with the design or when the shadows do not allow all the features of the design to be appreciated, for example because they interfere with, or hide parts of, the design or distort the contour of the design.

Examples of acceptable shadows or reflections

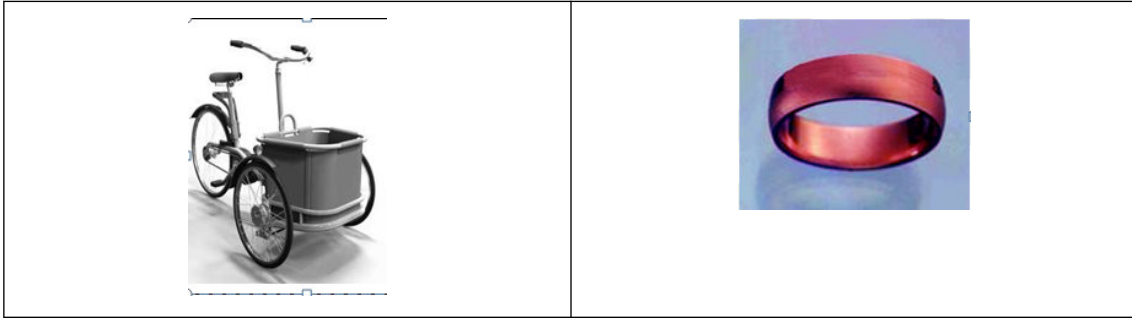
<b>Danish design No 2013 00069</b>	<b>CP6 example</b>
--	--------------------



Examples of unacceptable shadows or reflections

CP6 example	CP6 example
	

3.3.2.2 Elements external to the design

Views should not include external and foreign matter, except when their inclusion does not cast any doubt on the protection sought and serves only an illustrative purpose.

For example, the inclusion of a hand in the following design serves the purpose of illustrating how the product in which the design is incorporated will be used (even though the way of use does not form part of the design's subject-matter of protection). As a human hand is not eligible for design protection (see [paragraph 4.1.7](#) below) the subject matter of the design is clear.

**RCD No 1 627 233**





Likewise, when the background shows the context in which the design will be used, and the design itself uses visual disclaimers such as colour shading (see [paragraph 5.4.3](#) below) allowing for the features for which protection is sought to be clearly perceptible, the subject matter of the design is clear.

**RCD No 2 513 598 'Luggage carriers for cycles'**



However, the following examples are not acceptable as they contain elements that are external to the design, such as a dressmaker’s mannequin in the first design, and hand tools and other elements in the second, making the subject matter of protection unclear.

RCD No 5 631 504	RCD No 4 154 086
 <p data-bbox="233 1451 788 1523"><a href="#">This photo</a> by unknown author is licensed under <a href="#">CC BY-SA</a></p>	

### 3.3.2.3 Examination

Of the seven views allowed for representing a design (Article 4(2) CDIR), those that do not have a neutral background or that contain elements external to the design, will be objected to.

The examiner will issue a deficiency letter giving the applicant 2 months to remedy by:

- withdrawing the views concerned (which will not form part of the Community design); or
- submitting new views on a neutral background; or



- amending the views objected to so that the design is isolated from its background. This latter option will make use of visual disclaimers (see [paragraph 5.4](#) below).

If the applicant withdraws the deficient view(s) within the time limit set by the Office, the date of receipt of the original application will be recorded as the date of filing for the views that are not deficient.

If the applicant submits new or amended views within the time limit set by the Office, the date of receipt of these views will be recorded as the date of filing of the design.

If the deficiencies are not remedied within the time limit set by the Office, the application will not be dealt with as an application in accordance with Article 46(2) and Article 36(1)(c) CDR and Article 10(1)(c) CDIR. The file will be closed by a decision of the examiner and the applicant will be notified. The examiner will notify the Finance Department that a refund of any fees paid should be made to the applicant (Article 10(2) CDIR).

### **3.3.3 Designs retouched with ink or correcting fluid**

The design must not be retouched with ink or correcting fluid (Article 4(1)(e) CDIR).

Representations visibly retouched with ink or correcting fluid will be objected to and refused for the purpose of allocating a filing date.

#### **3.3.3.1 Examination**

The examiner will use a deficiency letter giving the applicant 2 months to remedy by:

- withdrawing the views concerned (which will not form part of the Community design); or
- submitting new views.

If the applicant withdraws the deficient view(s) within the time limit set by the Office, the date of receipt of the original application will be recorded as the date of filing for the views that are not deficient.

If the applicant submits new views within the time limit set by the Office, the date of receipt of these views will be recorded as the date of filing of the design.

If the deficiencies are not remedied within the time limit set by the Office, the application will not be dealt with as an application in accordance with Article 46(2) and Article 36(1)(c) CDR and Article 10(1)(c) CDIR. The file will be closed by a decision of the examiner and the applicant will be notified. The examiner will notify the Finance Department that a refund of any fees paid should be made to the applicant (Article 10(2) CDIR).





### 3.3.4 Quality

In accordance with Article 4(1)(e) CDIR, the design must be of a quality permitting all the details of the matter for which protection is sought to be clearly distinguished and permitting it to be reduced or enlarged to a size no greater than 8 cm by 16 cm per view for entry in the Community Designs Register and for direct publishing in the *Community Designs Bulletin*.

Poor quality views are those that do not allow the details of the design to be clearly distinguished.

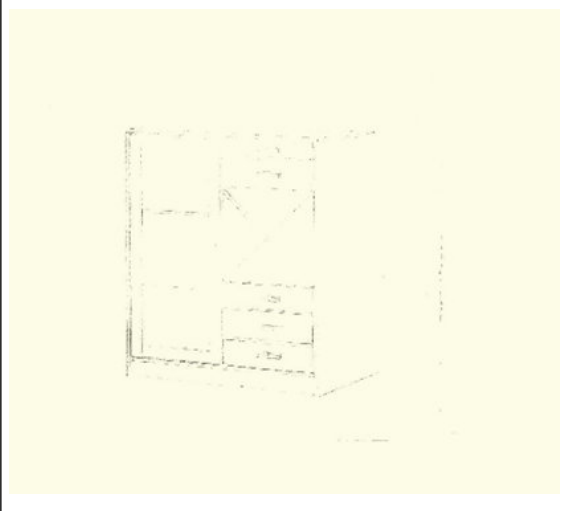
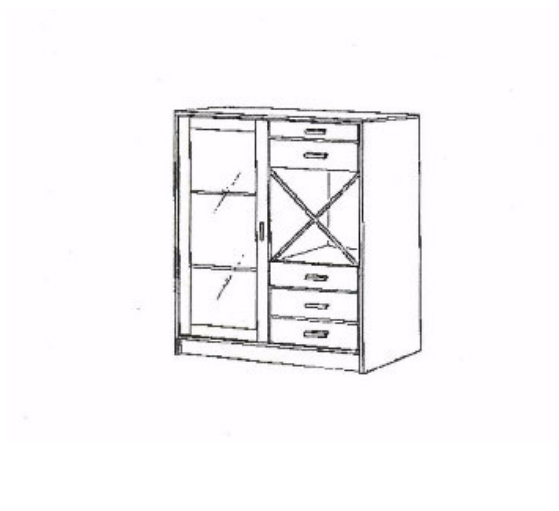
#### Examples

Poor Quality	Sufficient Quality
	
	

Poor quality views are also those that do not allow the design to be reduced or enlarged.

#### Examples

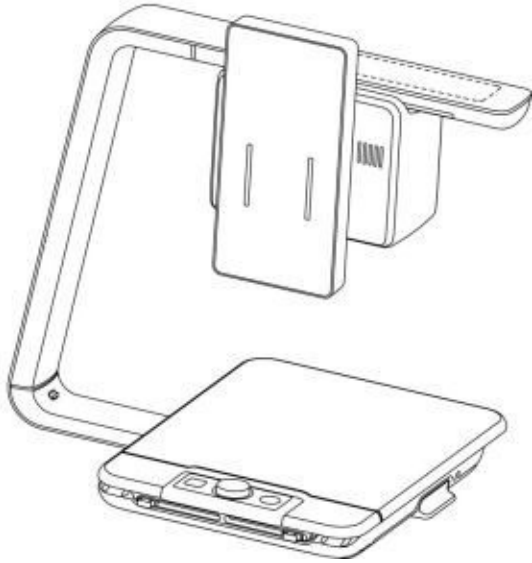
Poor quality	Sufficient Quality
	

#### 3.3.4.1 Examination

Where the design is not of a quality permitting all the details of the matter for which protection is sought to be clearly distinguished and permitting it to be reduced or enlarged, the examiner will issue a deficiency letter giving the applicant 2 months to remedy by:

- withdrawing the views concerned (which will not form part of the Community design); or
- submitting new views.

If the applicant withdraws the deficient view(s) within the time limit set by the Office, the date of receipt of the original application will be recorded as the date of filing for the views that are not deficient.

If the applicant submits new views within the time limit set by the Office, the date of receipt of these views will be recorded as the date of filing of the design.

If the deficiencies are not remedied within the time limit set by the Office, the application will not be dealt with as an application in accordance with Article 46(2) and Article 36(1)(c) CDR and Article 10(1)(c) CDIR. The file will be closed by a decision of the examiner and the applicant will be notified. The examiner will notify the Finance Department that a refund of any fees paid should be made to the applicant (Article 10(2) CDIR).

The requirement that the design must be of a quality permitting all the details of the matter for which protection is sought to be clearly distinguished, for publication purposes, applies equally to all applications, irrespective of the means of filing.

Applications sent by e-filing, however, raise specific issues.

### E-filing

For e-filing, the terms and conditions determined by the Office must be adhered to (see [Decision No EX-20-9](#) of the Executive Director of the Office of 3 November 2020 on communication by electronic means as well Article 9 for the technical requirements of RCD applications).

Low-resolution attachments are likely to be objected to due to their insufficient quality for reproduction and publication purposes where enlargement of the views to a size of 8 cm by 16 cm causes the details of the design to be blurred.

Where the electronic filing is incomplete or illegible the Office will issue a formal notification requesting the applicant to resend the application within **2 months**. If the deficiencies concern the filing date requirements pursuant to Article 10(1) CDIR, the date on which all deficiencies are remedied determines the date of filing (Article 10(2) CDIR in combination with Article 67(3) CDIR).

If the deficiencies are not remedied within the time limit set by the Office, the application will not be dealt with as an application in accordance with Article 46(2) and Article 36(1)(c) CDR and Article 10(1)(c) CDIR. The file will be closed by a decision of the examiner and the applicant will be notified. The examiner will notify the Finance Department that a refund of any fees paid should be made to the applicant (Article 10(2) CDIR).

Where it is clear that the electronic filing was deficient due to technical problems attributable to the Office, with the result that one or more views do not correspond to those originally submitted by the applicant, the Office will allow the resubmission of the affected views. The original filing date via e-filing will be retained, provided that there is no other deficiency affecting the filing date.

### **3.3.5 Specimens**

The graphic or photographic reproduction of the design can be substituted by a specimen of the design provided the following cumulative conditions are met:

- the application relates to a two-dimensional design; and
- the application contains a request for deferment (Article 36(1)(c) CDR; Article 5(1) CDIR).

In the event of a multiple application, the substitution of the representation by a specimen may apply only to some of the designs, provided these designs are two-dimensional and are subject to a request for deferment (see [paragraph 6.2.5](#)).

A specimen is usually a sample of a piece of material such as textile, wallpaper, lace, leather, etc.

Specimens must not exceed 26.2 cm x 17 cm in size, 50 g in weight or 3 mm in thickness. They must be capable of being stored and unfolded (Article 5(2) CDIR).

Five samples of every specimen must be filed; in the case of a multiple application, five samples of the specimen must be filed for each design (Article 5(3) CDIR).

The application and the specimen(s) must be sent in a single delivery either by post or personal delivery. A date of filing will not be accorded until both the application and the specimen(s) have reached the Office.

Where the applicant submits a specimen relating to an application that does not relate to a two-dimensional design or that does not contain a request for deferment, the specimen will not be admissible. In that case, the date of filing will be determined by the date on which the Office receives a suitable graphic or photographic reproduction of the design, provided the deficiency is remedied within 2 months of receipt of the Office's notification (Article 10(2) CDIR).

In principle, the specimen will be kept on file indefinitely (Decision No [EX-20-5](#) of the Executive Director of the Office of 15 June 2020 on the keeping of files).

Where a representation of the design has been replaced by a specimen in accordance with Article 5 CDIR, the applicant must file a graphic or photographic reproduction of the design 3 months before the 30-month deferment period expires at the latest, or 3 months before the requested date of publication at the latest (Article 15(1)(c) CDIR; see [paragraph 6.2.5.3](#)).

If the holder fails to file a graphic or photographic representation, the Office will issue a deficiency letter. If the holder fails to remedy the deficiency, the design will be deemed from the outset not to have had the effects specified in the Regulation.

## **4 Examination of the Substantive Requirements**

The Office carries out an examination of the substantive protection requirements, which is limited to two grounds for non-registrability.

An application will be refused if the design does not correspond to the definition set out in Article 3(a) CDR or if it is contrary to public policy or to accepted principles of morality (Article 9 CDR).

### **4.1 Compliance with the definition of a design**

A 'design' means the appearance of the whole or a part of a product resulting from the features of, in particular, the lines, contours, colours, shape, texture and/or materials of the product itself and/or its ornamentation (Article 3(a) CDR).

A 'product' means any industrial or handicraft item, including, inter alia, parts intended to be assembled into a complex product, packaging, get-up, graphic symbols and typographic typefaces, but excluding computer programs (Article 3(b) CDR).

Whether the product claimed is actually made or used, or can be made or used, in an industrial or handicraft manner will not be examined.

Whether a design discloses the appearance of the whole or a part of a 'product' will be examined in the light of the design itself, insofar as it makes clear the nature of the

product, its intended purpose or its function, and of the indication of the products in which the design is intended to be incorporated or to which it is intended to be applied (Article 36(2) CDR).

The following examples, albeit non-exhaustive, illustrate the Office's practice.

#### **4.1.1 Blueprints, technical drawings, plans for houses or other architectural plans of interior or landscape designs**

Blueprints, technical drawings, plans for houses or other architectural plans of interior or landscape designs (e.g. gardens) will be considered 'products' for the purpose of applying Article 7(1) CDR and will only be accepted with the corresponding indication of other printed matter in Class 19-08 of the Locarno Classification.

An objection will be raised if the product indicated in an application for a design consisting of a blueprint of a house is *houses* in Class 25-03 of the Locarno Classification. This is because a blueprint does not disclose the appearance of a finished product such as a house.

#### **4.1.2 Colours per se and combinations of colours**

A single colour may of course be an element of a design, but on its own it does not comply with the definition of a design because it does not constitute the 'appearance of a product'.

Combinations of colours may be accepted if it can be ascertained from the contours of the representation that they relate to a product such as, for instance, a logo or a graphic symbol in Class 32 of the Locarno Classification.

#### **4.1.3 Icons, graphic user interfaces and the like**

Designs of screen displays and icons, graphic user interfaces and other kinds of visible elements of a computer program are eligible for registration (see Class 14-04 of the Locarno Classification).

#### **4.1.4 Mere verbal elements**

Mere words per se and sequences of letters (written in standard characters in black and white) do not comply with the definition of a design because they do not constitute the appearance of a product.

The use of fanciful characters and/or the inclusion of a figurative element, however, render(s) the design eligible for protection either as a logo/graphic symbol in Class 32 of the Locarno Classification or as the ornamental representation of a part of any product to which the design will be applied.

### 4.1.5 Music and sounds

Music and sounds per se do not constitute the appearance of a product and, therefore, do not comply with the definition of a design.

However, the graphical representation of a musical composition, in the form of musical notation, would qualify as a design, if applied for as, for example, *other printed matter* in Class 19-08 or *graphic symbols* in Class 32 of the Locarno Classification.

### 4.1.6 Photographs

A photograph per se constitutes the appearance of a product and, therefore, complies with the definition of a design, irrespective of what it discloses. The indication of the product can be *writing paper, cards for correspondence and announcements* in Class 19-01, *other printed matter* in Class 19-08 of the Locarno Classification, or any product to which the design will be applied.

### 4.1.7 Living organisms

Living organisms are not 'products', that is, industrial or handicraft items. A design that discloses the appearance of plants, flowers, fruits etc. in their natural state will, in principle, be refused. Even if the shape at issue deviates from that of the common corresponding living organism, the design should be refused if nothing suggests prima facie that the shape is the result of a manual or industrial process (18/02/2013, [R 595/2012-3](#), GROENTE EN FRUIT, § 11).

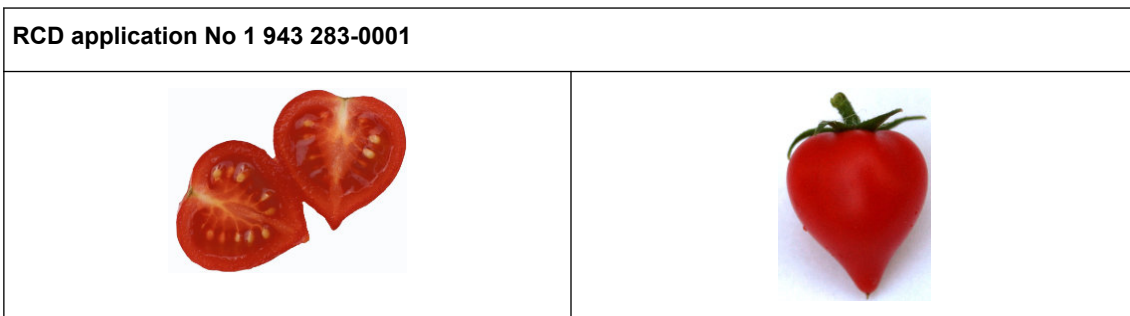

However, no objection will be raised if it is apparent from the representation that the product does not show a living organism or if the indication of the product specifies that the product is artificial (see, in particular, Class 11-04 of the Locarno Classification).

### **4.1.8 Teaching materials**

Teaching materials such as graphs, charts, maps, etc. can be representations of products in Class 19-07 of the Locarno Classification.

### **4.1.9 Concepts**

A design application will be refused where the representation is of a product that is simply one example amongst many of what the applicant wishes to protect. An exclusive right cannot be granted to a 'non-specific' design that is capable of taking on a multitude of different appearances. This is the case where the subject matter of the application relates, inter alia, to a concept, an invention or a method for obtaining a product.

## **4.2 Public policy and morality**

The Office will apply the concepts of public policy and morality as explained in the Guidelines, [Part B, Examination, Section 4, Absolute Grounds for Refusal, Chapter 7, Trade marks contrary to public policy or acceptable principles of morality \(Article 7\(1\)\(f\) EUTMR\)](#).

## **4.3 Objections**

Where an objection is raised by the examiner in respect of one of the two above grounds for non-registrability, the applicant will be given the opportunity to withdraw or amend the representation of the design or to submit its observations within 2 months (Article 47(2) CDR, Article 11 CDIR).

If the objection relates to compliance with the definition of a design and if this objection can be overcome by amending the indication of the products in which the design is intended to be incorporated or to which it is intended to be applied, the examiner will propose such an amendment in the communication to the applicant.

Where the applicant opts to submit an amended representation of the design, this representation will be admissible provided that 'the identity of the design is retained' (Article 11(2) CDIR). The date of receipt of the original application will remain as the date of filing.

Maintenance in an amended form will, therefore, be limited to cases in which the removed or disclaimed features are so insignificant in view of their size or importance that they are likely to pass unnoticed.

Features can be disclaimed by making use of the visual disclaimers referred to in [paragraph 5.3](#) below.

Where the applicant fails to overcome the grounds for non-registrability within the time limit, the Office will refuse the application. If those grounds concern only some of the designs contained in a multiple application, the Office will refuse the application only insofar as those designs are concerned (Article 11(3) CDIR).

## 5 Additional Requirements Regarding the Representation of the Design

The purpose of the graphic representation is to disclose the features of the design for which protection is sought. The graphic representation must be self-contained in order to determine with clarity and precision the subject matter of the protection afforded by the registered Community design to its holder. This rule is dictated by the requirement of legal certainty.

In accordance with the Common Practice (CP6), use of aspect views of the design is recommended.

Aspect views are defined under the Common Practice (CP6) as showing the design from certain directions (angles), and encompass the following: perspective view(s), front view, top view, right side view, left side view, back view and bottom view. See the following examples (for all but a bottom view).



For the purpose of filing a design, it is sufficient to file only one aspect view. However, other (non-traditional) types of view, in particular exploded views (see [paragraph 5.3.2](#) below) and sectional views (see [paragraph 5.3.5](#) below), cannot be filed on their own.

Applicants are reminded that the requirements concerning the format of the representation of the design may vary according to how the application is filed (e.g. e-filing, paper, use of a specimen). These requirements are set out in Articles 4 and 5 CDIR, and the technical requirements for applications filed electronically are listed in Article 9 of the [Decision No EX-20-9](#) of the Executive Director of the Office of 3 November 2020 on communication by electronic means.

The following instructions supplement the requirements regarding the quality of the reproduction and the neutral background (see [paragraph 3.3](#) above). For general quality recommendations for representations filed in the form of drawings or photographs, please consult the Common Practice (CP6). <sup>(4)</sup>

<sup>4</sup> <https://www.tmdn.org/network/converging-practices>.



The following instructions apply to all designs, irrespective of how the application was filed.

Even where a representation of the design has been replaced by a specimen in accordance with Article 5 CDIR (see [paragraph 3.3.5](#) above), the applicant must file a graphic or photographic reproduction of the design at the latest 3 months before the 30-month deferment period expires, or at the latest 3 months before the requested date of publication (Article 15(1)(c) CDIR; see [paragraph 6.2.5.3](#) below).

Any deficiency found in an application and relating to one of the requirements in this section will have no bearing on the granting of a filing date. However, if the deficiencies are not remedied within the time limit set by the Office in its examination report, the application will be refused (Article 46(3) CDR). If the deficiencies concern only some of the designs contained in a multiple application, the Office will refuse the application only insofar as those designs are concerned (Article 11(3) CDIR).

Once a date of filing has been granted, refusal of the application does not give rise to a refund of the fees paid by an applicant (Article 13 CDIR).

## **5.1 Number of views**

A maximum of seven different views can be filed in order to represent the design (Article 4(2) CDIR). The views may be plan, in elevation, cross-sectional, in perspective or exploded. Only one copy of each view should be filed.

For applications other than e-filings, each of the views must be numbered by the applicant in Arabic numerals separated by a dot, the first numeral being the number of the design, the second being the number of the view. For instance, the sixth view of the second design of a multiple application must be numbered '2.6'.

In cases where more than seven views are provided, the Office will disregard any of the extra views for registration and publication purposes (27/10/2009, [R 571/2007-3](#), Frames for cycles or motorcycles, § 13), although they will remain in the file. The Office will take the views in the consecutive order in which they have been numbered by the applicant (Article 4(2) CDIR).

Where a reproduction comprises less than seven views and the views are not numbered, the examiner will number the views according to the sequence given in the application.

The examiner will not change the order of the views as appearing in the application, or their orientation.

## **5.2 Consistency of the views**

The examiner will check whether the views relate to the same design, that is, to the appearance of one and the same product or of its parts.

It is the applicant's responsibility to submit a correct and complete application (including representations of the design). The Office is not entitled to remedy any deficiencies in respect of incongruent views once the Community design is registered and published (03/12/2013, [R 1332/2013-3](#), Adapters, § 14 et seq.).

### 5.2.1 Combination of several means of visual representation

Regarding the combination of several means of visual representation, it is recommended, in accordance with the Common Practice (CP6), that a design be represented using only one visual format (e.g. a drawing or a photograph). Therefore, the following combination of a drawing and a photograph depicting a vehicle toy, as shown in the Common Practice (CP6), is considered unacceptable and thus should not be filed.

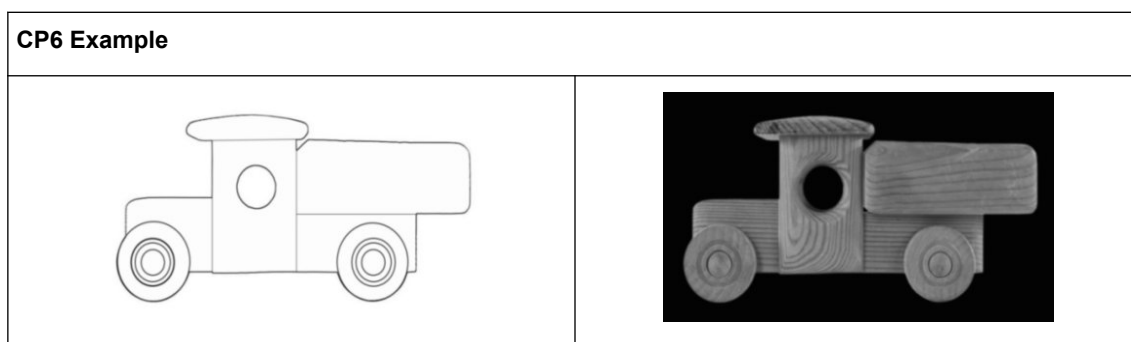

Where different visual formats are used, each must clearly relate to the same design and be consistent when comparing the features disclosed.

When the different visual formats show aspects that are inconsistent with one another, they are not considered to represent the same design. A combination of a drawing and a photograph will usually reveal inconsistencies between representations in different visual formats.

In the following example of a chair design, the seat is flat in the drawing but arched in the photograph. The backrests are also of a different shape.

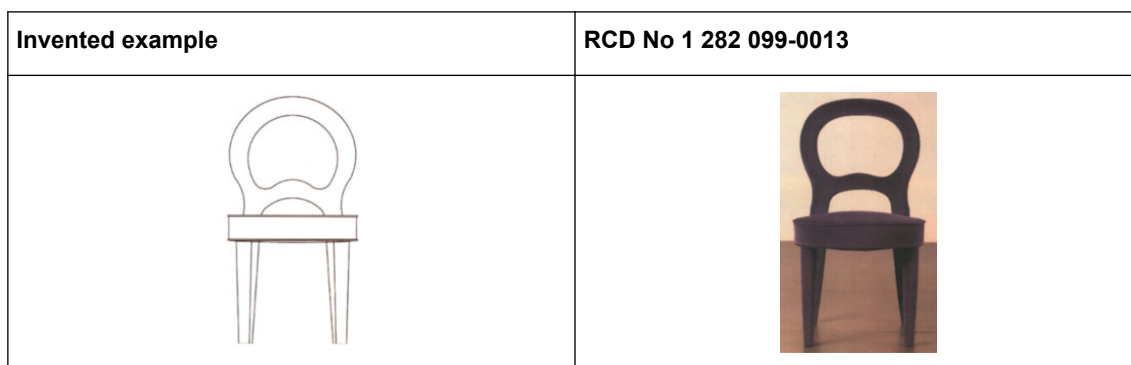

The same may apply when the graphic representation indicates features other than contour lines, such as surface features that are not consistent with the corresponding features in the photographic representation.

The Office therefore strongly recommends that applicants wishing to use different visual formats file each one as a separate design (e.g. one design consisting of drawings only, the other of photographs); these can also be combined in a multiple application.

Where the use of different visual formats leads to an inconsistency of views showing more than one design, the examiner will issue a deficiency letter giving up the applicant 2 months to remedy by:

- withdrawing the views representing other designs;
- provided 'unity of class' can be maintained (see [paragraph 7.2.3](#) below), converting its application into a multiple application in which the inconsistent view(s) form separate design(s), and paying the corresponding fees;
- if 'unity of class' cannot be maintained, converting its application into separate applications, and paying the corresponding fees.

If the applicant withdraws the inconsistent view(s) or converts its application into multiple or separate applications within the time limit set by the Office, the date of receipt of the original application will be the date of filing.

If the deficiencies are not remedied within the time limit set by the Office, the application will be refused under Article 47(1)(a) CDR and Article 11(3) CDIR. As a date of filing has been granted, refusal of the application does not give rise to a refund of the fees paid (Article 13 CDIR).

## **5.2.2 Views relating to more than one design**

Views relate to more than one design when there are different embodiments of the same concept, or when the lines used to identify the design or the disclaimers used to disclaim certain features are not used consistently throughout the views.

Different embodiments of the same concept cannot be grouped in a single application because each embodiment is a design on its own. It should not be confused with sets of articles (see [paragraph 5.3.7](#) below).

Different embodiments of the same concept are considered to be different designs.

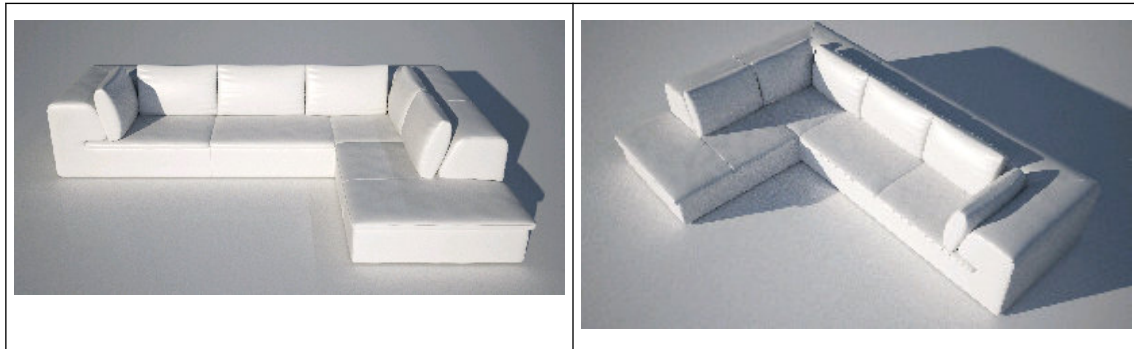

Lines and disclaimers must be consistent throughout all the views.

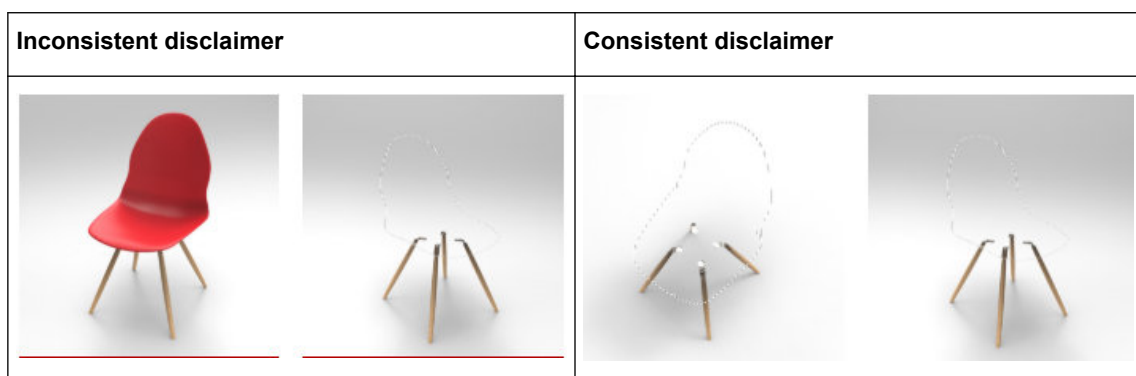

Where the application contains different embodiments or where the use of lines or visual disclaimers leads to an inconsistency of views showing more than one design, the examiner will issue a deficiency letter giving the applicant 2 months to remedy by:

- withdrawing the views representing other designs;
- provided 'unity of class' can be maintained (see [paragraph 7.2.3](#) below), converting its application into a multiple application in which the inconsistent view(s) form separate design(s), and paying the corresponding fees;
- if 'unity of class' cannot be maintained, converting its application into separate applications, and paying the corresponding fees.

If the applicant withdraws the inconsistent view(s) or converts its application into multiple or separate applications within the time limit set by the Office, the date of receipt of the original application will be the date of filing.

If the deficiencies are not remedied within the time limit set by the Office, the application will be refused under Article 47(1)(a) CDR and Article 11(3) CDIR. As a date of filing has been granted, refusal of the application does not give rise to a refund of the fees paid (Article 13 CDIR).

### 5.2.3 Colours

The representation of the design may be submitted **either** in black and white (monochrome) **or** in colour (Article 4(1) CDIR).

Representations combining black and white views with colour views will be objected to due to their inconsistency and the resulting legal uncertainty as to the protection sought.



The same reasoning applies where identical features of a design are represented in different colours in the various views. Such an inconsistency suggests that the application relates to more than one design (31/03/2005, [R 965/2004-3](#), Bandmaß, § 18-20; 12/11/2009, [R 1583/2007-3](#), Bekleidung, § 9-10).

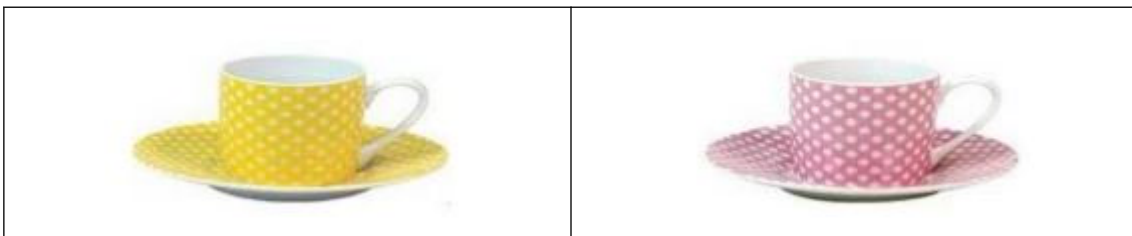

Where the use of different colours leads to an inconsistency of views showing more than one design, the examiner will issue a deficiency letter giving the applicant 2 months to remedy by:

- withdrawing the views representing other designs;
- provided 'unity of class' can be maintained (see [paragraph 7.2.3](#) below), converting its application into a multiple application in which the inconsistent view(s) form separate design(s), and paying the corresponding fees;
- if 'unity of class' cannot be maintained, converting its application into separate applications, and paying the corresponding fees.

If the applicant withdraws the inconsistent view(s) or converts its application into multiple or separate applications within the time limit set by the Office, the date of receipt of the original application will be the date of filing.

If the deficiencies are not remedied within the time limit set by the Office, the application will be refused under Article 47(1)(a) CDR and Article 11(3) CDIR. As a date of filing has been granted, refusal of the application does not give rise to a refund of the fees paid (Article 13 CDIR).

However, as an exception to the above principle, the same features of a design can be represented in different colours in the various views if the applicant submits evidence, within the time limit set by the Office to remedy the deficiency, that the change of colours at different points in time, while the product is in use, is one of the relevant features of the design, as in the example below (RCD No 283 817-0001, courtesy of ASEM Industrieberatung und Vermittlung).

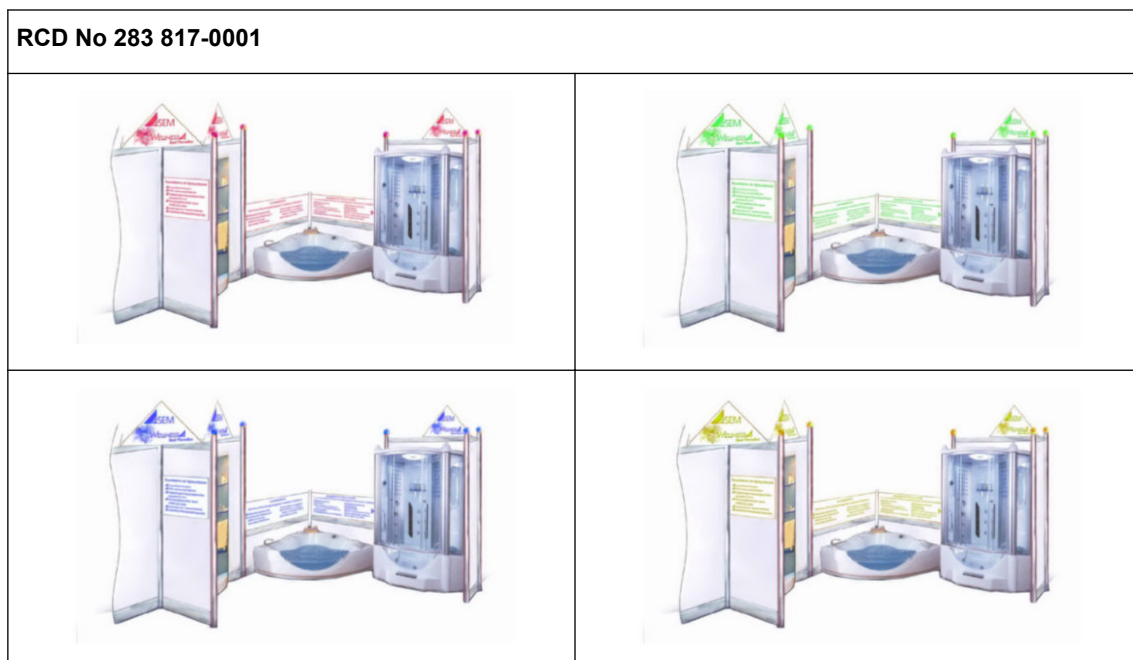

Where the representation is in colour, the registration and publication will also be in colour (Article 14(2)(c) CDIR).

## 5.3 Specific requirements for the different types of views

### 5.3.1 Alternative positions

Designs with alternative positions are of an appearance that can be modified into various configurations without adding or removing any parts.

These designs have predefined stages of use that each correspond to an alternative position.

In accordance with the Common Practice (CP6), views showing different configurations of the design are acceptable provided no parts have been added or deleted.

The alternative positions of the movable or removable parts of a design must be shown in separate views.

The example below of an acceptable representation of a design with alternative positions is taken from the Common Practice (CP6), which also lists additional examples.

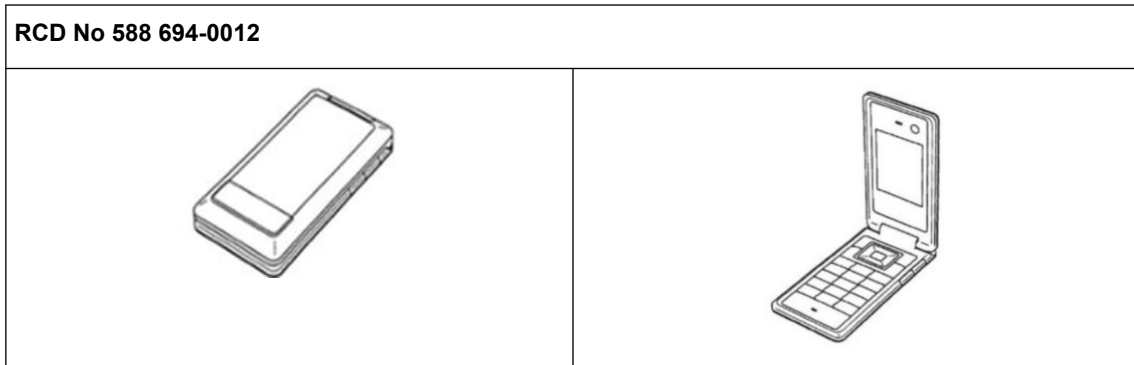

In some cases, different configurations may result in different products, such as the bag that can be converted into a towel.

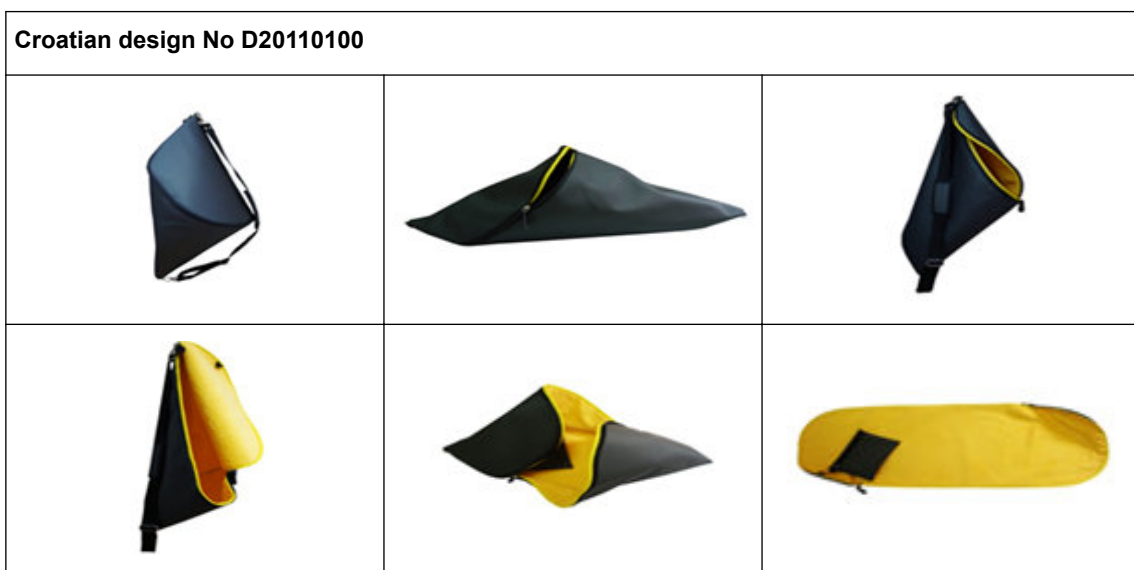

### 5.3.2 Exploded views

Exploded views are views where parts of a product are shown disassembled, to clarify how the parts fit together.

Exploded views must be combined with at least one view representing the assembled product. In these views, all the product's parts must be shown disassembled in a separate single view. The disassembled parts must be shown in close proximity and in order of assembly.



The example below of an acceptable representation of a design with an assembled and an exploded view is taken from the Common Practice (CP6), which also lists additional examples.



Where there is no view showing the assembled product, the examiner will issue a deficiency letter giving the applicant 2 months to remedy by submitting such a view showing the assembled product for which protection is sought. The new view should not contain features that were not included in the original representation of the design. The original filing date will be retained.

If the deficiencies are not remedied within the time limit set by the Office, the application will be refused under Article 47(1)(a) CDR and Article 11(3) CDIR. As a date of filing has been granted, refusal of the application does not give rise to a refund of the fees paid (Article 13 CDIR).

### 5.3.3 Views magnifying part of the design

Magnified views show one part of an overall design on an enlarged scale.

A single magnified view is acceptable provided that the magnified part is already visible in one of the other views submitted.

The view that shows the magnified part of the design must be presented in a separate single view.

Example of an unacceptable magnified view filed as one view





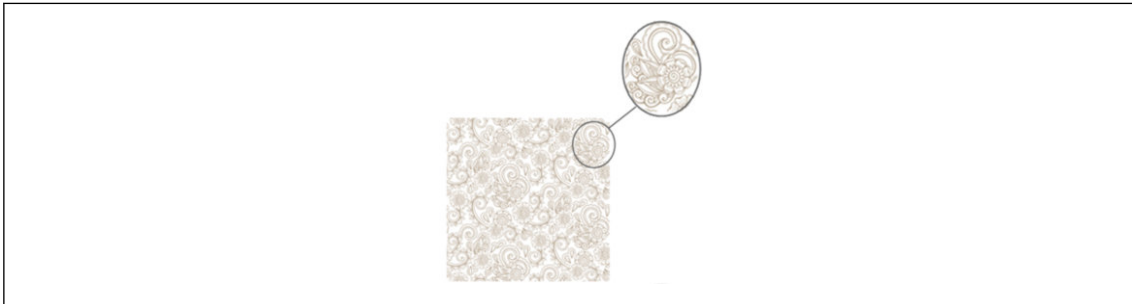

Example of an acceptable magnified view filed as a separate view

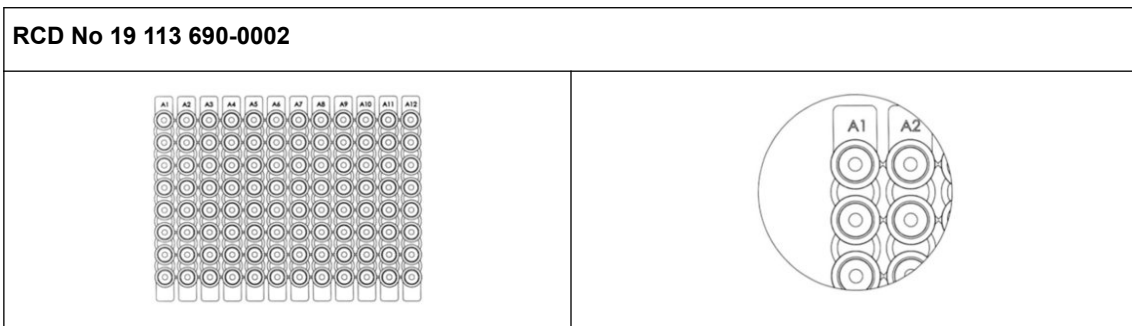

Where the magnified view is filed within another view, the examiner will issue a deficiency letter inviting the applicant to submit the view showing the magnification separately, which should not contain features that were not included in the original representation of the design. The original filing date will be retained.

If the deficiencies are not remedied within the time limit set by the Office, the application will be refused under Article 47(1)(a) CDR and Article 11(3) CDIR. As a date of filing has been granted, refusal of the application does not give rise to a refund of the fees paid (Article 13 CDIR).

### 5.3.4 Partial views

A partial view is a view showing part of a product in isolation. A partial view can be magnified.

Partial views must be combined with at least one view of the assembled product (the different parts need to be connected to each other).

Example of an acceptable assembled view, filed together with partial views

<b>RCD No 2 038 216-0001</b>			
<b>Assembled view</b>	<b>Partial view</b>	<b>Partial view</b>	<b>Partial view</b>



Where all the views disclose different detailed parts, **without showing these parts connected to each other**, the examiner will issue a deficiency letter giving the applicant 2 months to remedy by:

- withdrawing the views representing other designs;
- provided ‘unity of class’ can be maintained (see [paragraph 7.2.3](#) below), converting its application into a multiple application in which the inconsistent view(s) form separate design(s) and paying the corresponding fees;
- if ‘unity of class’ cannot be maintained, converting its application into separate applications, and paying the corresponding fees.

If the applicant withdraws the deficient view(s) or converts its application into multiple or separate applications within the time limit set by the Office, the date of receipt of the original application will be the date of filing.

If the deficiencies are not remedied within the time limit set by the Office, the application will be refused under Article 47(1)(a) CDR and Article 11(3) CDIR. As a date of filing has been granted, refusal of the application does not give rise to a refund of the fees paid (Article 13 CDIR).

### 5.3.5 Sectional views



Sectional views are cutaway portions that complement aspect views by illustrating a feature or features of the product’s appearance, such as contour, surface, shape or configuration.

In accordance with the Common Communication on Convergence on graphic representations of designs ([CP6](#)), representations with technical indications, such as axial lines or sizes (dimensions), numbers, etc., are not acceptable. The sectional view should be an unambiguous view of the same design. Sectional views should not be submitted without other traditional views, such as aspect views.

Where the sectional view is submitted alone, without other aspect views, and the subject matter of protection is unclear, the examiner will issue a deficiency letter giving the applicant 2 months to remedy by submitting such a view showing the product for which protection is sought. The original filing date will be retained provided the new view contains no additional features that were not included in the sectional view originally submitted.

If the deficiencies are not remedied within the time limit set by the Office, the application will be refused under Article 47(1)(a) CDR and Article 11(3) CDIR. As a date of filing has been granted, refusal of the application does not give rise to a refund of the fees paid (Article 13(3) CDIR).

The following are examples, agreed in the context of the [CP6](#), of sectional views which must be filed together with other traditional views, such as aspect views.

<b>Spanish design No I0152702-D</b>	
<b>Aspect view</b>	<b>Sectional view</b>
	

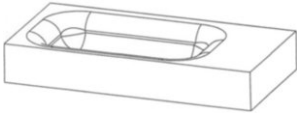
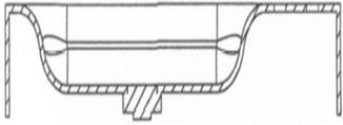





<b>Benelux design No 38478-0002</b>	
<b>Aspect view</b>	<b>Sectional view</b>
	

### 5.3.6 Sequence of snapshots (animated designs)

Snapshots are a short sequence of views used to show a single animated design at different specific moments in time, in a clearly understandable progression.

This applies to, for example:

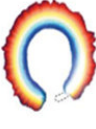
- an animated icon (design consisting of a sequence)

<b>RCD No 2 085 894-0014</b>						
						

- an animated graphical user interface (design of an interface)

RCD No 1 282 388-0031



In principle, according to the Common Practice (CP6), all views of an animated icon or graphical user interface need to be visually related, which means that they must have features in common. It is the applicant's responsibility to order the views in such a way as to give a clear perception of the movement/progression.

### 5.3.7 Sets of articles

A set of articles is a group of products of the same kind that are generally regarded as belonging together and are so used. See the example below.

RCD No 938 709-0001



Sets of articles should not be confused with variations of a design. Different embodiments of the same concept cannot be grouped in a single application because each embodiment is a design on its own. See [paragraph 5.2.2](#), Views relating to more than one design.

The difference between a complex product and a set of articles is that, in contrast to a complex product, the articles of a 'set of articles' are not mechanically connected.

A set of articles can be a 'product' in itself within the meaning of Article 3 CDR. It can be represented in a single design application if the articles making up this set are linked by **aesthetic and functional complementarity** and are, in normal circumstances, sold together as one single product, like a chess board and its pieces, or sets of knives, forks and spoons.

It must, however, be clear from the representation that protection is sought for a design resulting from the combination of the articles making up the set, and not for each article separately.

Applicants must submit, among the seven views allowed, at least one view showing the set of articles in its entirety.

Where there is no view showing the set of articles in its entirety, the examiner will issue a deficiency letter giving the applicant 2 months to remedy by:

- withdrawing the views so that the remaining views represent only one design;
- provided 'unity of class' can be maintained (see [paragraph 7.2.3](#)), converting its application into a multiple application in which the inconsistent view(s) form separate design(s), and paying the corresponding fees;
- if 'unity of class' cannot be maintained, converting its application into separate applications, and paying the corresponding fees.

If the applicant withdraws the view(s) or converts its application into multiple or separate applications within the time limit set by the Office, the date of receipt of the original application will be the date of filing.

If the deficiencies are not remedied within the time limit set by the Office, the application will be refused under Article 47(1)(a) CDR and Article 11(3) CDIR. As a date of filing has been granted, refusal of the application does not give rise to a refund of the fees paid (Article 13 CDIR).

### **5.3.8 Repeating surface patterns**

Where the application concerns a design consisting of a repeating surface pattern, the representation of the design must disclose the complete pattern and a sufficient portion of the repeating surface (Article 4(3) CDIR) in order to show how this pattern is infinitely multiplied.

Where there is no indication in the application that the design consists of a repeating surface pattern, the Office will assume that this is not the case and will not request a sufficient portion of the repeating surface.

If additional views represent the pattern applied to one or more specific products for illustrative purposes, the applicant must make sure that the shape of such products is not claimed as part of the design by using any method referred to under [paragraph 5.4](#) below.

If the deficiencies are not remedied within the time limit set by the Office, the application will be refused under Article 47(1)(a) CDR and Article 11(3) CDIR. As a date of filing has been granted, refusal of the application does not give rise to a refund of the fees paid (Article 13 CDIR).

**RCD 6 574 695-0004**



### 5.3.9 Typographic typefaces

Where the application concerns a design consisting of a typographic typeface, the representation of the design must consist of a string of all the letters of the alphabet, upper case and lower case, and of all the Arabic numerals, as well as of a text of five lines produced using that typeface, all in the same pitch font (Article 4(4) CDIR). The four requirements for typographic typefaces may be submitted in separate views. Typographic typefaces may concern different alphabets in a single application once the four requirements above are met.

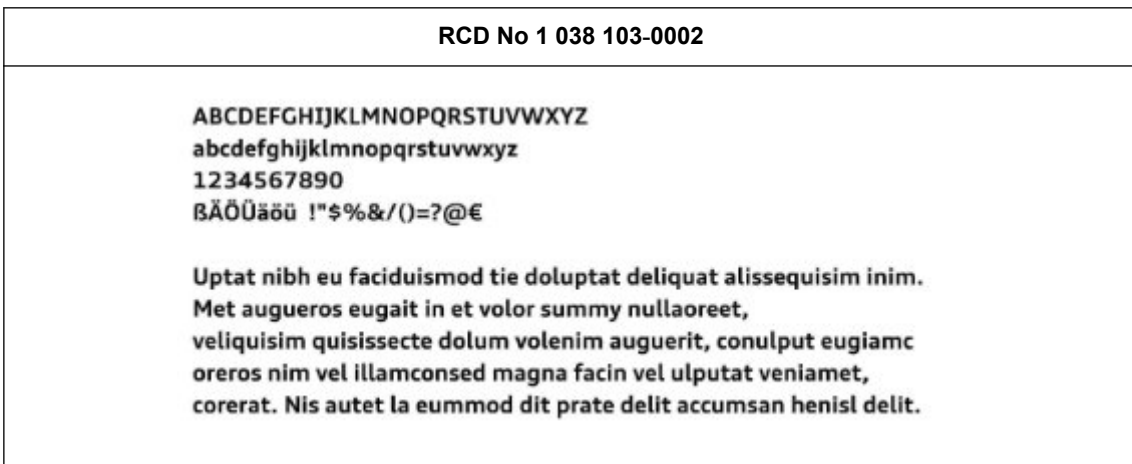

RCD 2458810-0001

## Rappresentazione

<p>                     A B C D E F G H I J                      K L M N O P Q R S                      T U V W X Y Z                      0001.1                 </p>	
<p>                     Lorem ipsum dolor sit amet, consectetur                      adipiscing elit. Phasellus luctus turpis                      neque, quis rutrum urna iaculis congue.                      Sed metus tellus, hendrerit scelerisque                      porttitor nec, fringilla quis diam.                      0001.3                 </p>	<p>00</p>

Figure 1:

Where the application does not include a text of five lines using the typeface concerned (Article 4(4) CDIR), the applicant will be requested to submit such a text or to accept a change in the indication of products to ‘set of characters’ in Class 18-03 of the Locarno Classification.

If the deficiencies are not remedied within the time limit set by the Office, the application will be refused under Article 47(1)(a) CDR and Article 11(3) CDIR. As a date of filing will have been granted, refusal of the application will not lead to a refund of the fees paid (Article 13 CDIR).



## 5.4 Use of visual disclaimers to exclude features from protection

Neither the CDR nor the CDIR provides rules for the possibility of including in the application a statement that the applicant disclaims any exclusive right to one or more features disclosed in the views.

Use of a description within the meaning of Article 36(3)(a) CDR is not appropriate in this regard since a description 'shall not affect the scope of protection of the design as such' according to Article 36(6) CDR (see [paragraph 6.2.2](#) below). Moreover, only an indication that a description has been filed is published, not the description as such (Article 14(2)(d) CDIR).

Disclaimers must therefore be apparent from the representation of the design itself.

In accordance with the Common Practice (CP6), visual disclaimers indicate that protection is not being sought, and registration has not been granted, for certain features of the design shown in the representation. Thus, they indicate what is not intended to be protected. This can be achieved:

- by excluding with broken lines, blurring or colour shading the features of the design for which protection is not sought; or
- by including the features of the design for which protection is sought within a boundary, thus making it clear that no protection is sought for what falls outside the boundary.

Under the Common Practice (CP6), the offices agreed on the general recommendation that graphic or photographic representations showing only the claimed design are preferred. However, visual disclaimers can be used when the graphic or photographic representation of the design contains parts of the product for which no protection is sought. In these cases, the disclaimer must be clear and obvious; the claimed and disclaimed features must be clearly differentiated.

To be accepted, when the design is represented by more than one view, the visual disclaimer must be shown consistently in all the views where it appears (see [paragraph 5.2.2](#)).

Where a disclaimer is used, broken lines are recommended. Only when broken lines cannot be used due to technical reasons (e.g. when they are used to indicate stitching on clothing or patterns, or when photographs are used), can other disclaimers be used, such as colour shading, boundaries or blurring.

In accordance with the Common Practice (CP6), in an application for registration of a Community design, the following visual disclaimers will be allowed (see [paragraphs 5.4.1](#) to [5.4.4](#) below).



### 5.4.1 Broken lines

Broken lines consist of a trace made up of dots or dashes (or a combination of both), and are used to indicate that no protection is sought for features shown using the interrupted trace.

A visual disclaimer consisting of broken lines will usually be combined with continuous lines.

To be accepted, the features for which protection is not sought should be clearly indicated with broken lines, whereas the parts for which protection is sought should be indicated with continuous lines.

The following are examples agreed in the context of the Common Practice (CP6) for correctly applied broken lines.

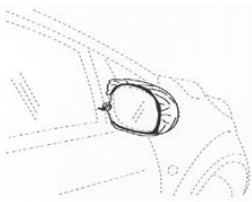
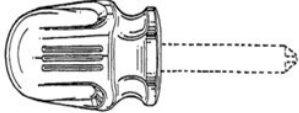
<b>RCD</b> <b>No 30 606-0005</b>	<b>Benelux design</b> <b>No 38212-0001</b>	<b>Hungarian design</b> <b>No D9900409-0001</b>
		

In cases where broken lines are a feature of the design (such as stitching on clothing), this must be clear from the representation. In such cases, it may be helpful to file, for example, a magnified view.

In cases where broken lines are a feature of the design and a part of the design needs to be disclaimed, any of the other visual disclaimers can be used, such as colour shading, blurring or boundaries.

For ease of illustration, broken lines may also illustrate separations, indicating that the precise length of the design is not claimed (indeterminate length).

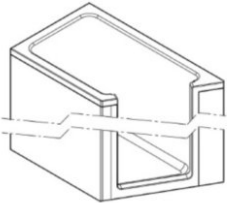
<b>RCD No 2 509 430-0001</b>

In view of the Common Practice (CP6), the Office does not recommend using broken lines to indicate portions of the design that are not visible in that particular view, that is to say, non-visible lines.

### 5.4.2 Blurring

Blurring is a type of visual disclaimer that consists in obscuring the features for which protection is not sought in the drawings or photographs of a design application.

Blurring may only be accepted when the features for which protection is sought are clearly distinguishable from the disclaimed (blurred) features.

The following is an example agreed in the context of the Common Practice (CP6) of correctly applied blurring.



### 5.4.3 Colour shading

Colour shading is a type of visual disclaimer that consists in using contrasting tones to sufficiently obscure the features for which protection is not sought in the drawings or photographs of a design application.

With colour shading, the features for which protection is sought must be clearly perceptible, whereas the disclaimed features must be represented in a different tone and so as to appear blurred or imperceptible.

The following are examples agreed in the context of the Common Practice (CP6) for correctly applied colour shading.

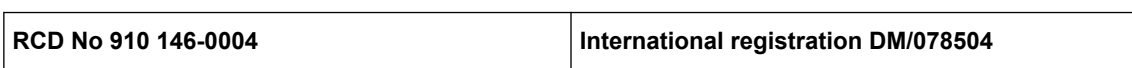

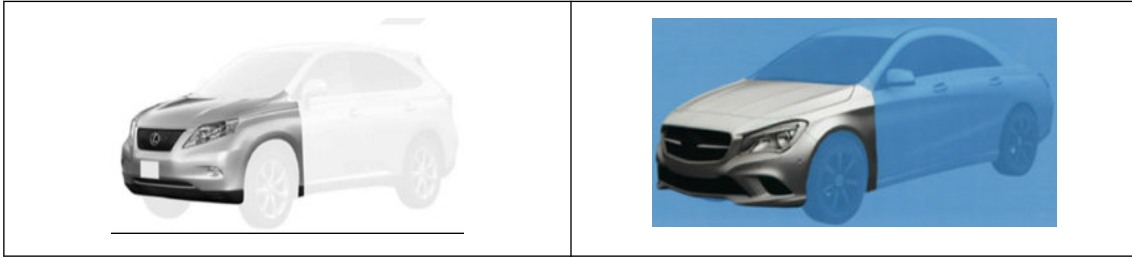

Further examples of Office practice.



#### 5.4.4 Boundaries



Boundaries are a type of visual disclaimer used in drawings or photographs of a Community design application to indicate that no protection is sought for the features not contained within the boundary.

The following are examples agreed in the context of the Common Practice (CP6) for correctly applied boundaries.



In order to be accepted, the features for which protection is sought should be clearly indicated/represented within the boundary, whereas all the features outside the boundary are considered to be disclaimed and therefore not protected.

Due to the risk of including more than just the design within the boundary, boundaries must be used carefully in drawings/photographs. The following are examples of incorrectly applied boundaries.

CP6 example	CP6 example
	

## 5.5 Explanatory text, wording or symbols

No explanatory text, wording or symbols may be displayed in the views.

For paper filings only the indication ‘top’ or the name or address of the applicant may appear (Article 4(1)(c) CDIR).

Where words, letters, numbers and symbols (such as arrows) are **clearly** not part of the design, the examiner may cut them from the views using the specific IT tool available for this. If the examiner is not able to cut them out for technical reasons, the applicant will be requested to send in clean views or to withdraw the deficient ones.

Where the words, letters, numbers, etc. are part of the design (graphical symbol), the design is acceptable.

Verbal elements displayed in the representation that are part of the design will be keyed in and entered in the file. Where several verbal elements are displayed, the examiner will only take into account the most prominent one.

## 5.6 Amending and supplementing views

**As a matter of principle, the representation may not be altered after the application has been filed.** The submission of additional views or the withdrawal of some views will therefore not be accepted (Article 12(2) CDIR), unless expressly allowed or required by the Office (see paragraphs [3.3](#), [4.3](#) and [5.3](#) above).

In particular, the views initially filed may not be replaced with better-quality ones. The representations examined and published will be those that the applicant provided in its original application.

The submission of amended or additional views, where allowed, must be made by electronic communication via the Office's website (not by email) in JPEG format (for further information on other formats and technical requirements, see: <https://euipo.europa.eu/ohimportal/en/attachments>), or by post.

## **6 Additional Elements that an Application Must or May Contain**

### **6.1 Mandatory requirements**

In addition to the requirements for the grant of a filing date (see [paragraph 3](#) above), the application must properly identify the applicant and, if applicable, its representative (Article 1(b) and (e) CDIR), specify the two languages of the application (Article 1(h) CDIR), contain a signature (Article 1(i) CDIR) and indicate the products in which the design is intended to be incorporated or to which it is intended to be applied (Article 1(d) CDIR).

Even after a date of filing has been granted, the examiner will issue an objection if a deficiency with regard to any of the above requirements is noted in the course of examining the Community design application (Article 10(3)(a) CDIR).

#### **6.1.1 Identification of the applicant and its representative**

Pursuant to Article 1(b) CDIR, an application will be objected to if it does not contain the following information regarding the applicant: its name, address and nationality and the State in which it is domiciled or, if the applicant is a legal entity, in which it has its seat or establishment. The Office identifies the applicant and, where applicable, its representative, according to the principles set out in the Guidelines [Part A, General rules, Section 5, Parties to the proceedings and professional representation, paragraph 3, Identification of parties to the proceedings](#).

#### **6.1.2 Specification of the languages**

The application may be filed in any of the official languages of the European Union (language of filing) (Article 98(1) CDR; see [paragraph 2.4](#) above). The language of the application form does not affect the language of the application. It is the language of the text entered by the applicant that is decisive. The language of filing will be the first language of the application.

The applicant must indicate a second language, which must be an Office language, that is, English (EN), French (FR), German (DE), Italian (IT) or Spanish (ES).

The second language must be different from the language of filing.

The two-letter ISO (International Organization for Standardization) codes for identifying languages may be used in the box provided in the application form.

### **6.1.3 Signature**

The application must be signed by the applicant (Article 1(i) CDIR). Where there is more than one applicant, the signature of one of them will be sufficient.

If an application is filed electronically, it is sufficient for the name and authority of the signatory to be indicated.

### **6.1.4 Indication of products**

#### **6.1.4.1 General principles**

Pursuant to Article 36(2) CDR, an application for a Community design must indicate the products in which the design is intended to be incorporated or to which it is intended to be applied. Pursuant also to Article 1(1)(d) CDIR and Article 3(3) CDIR, the indication of products must be worded in such a way as to indicate clearly the nature of the products and to enable each product to be classified in only one class of the Locarno Classification, preferably using the terms appearing in the list of products set out therein, or in DesignClass (see below).

In addition to only being capable of being classified in a single class, for administrative purposes the indication of product must be worded sufficiently clearly so as to be able to be classified in a single subclass.

Neither the product indication nor the classification affects the scope of protection of a Community design as such (Article 36(6) CDR). A registered Community design confers on its holder the exclusive right to use the relevant design in all types of products, and not only in the product indicated in the application for registration (21/09/2017, [C-361/15 P](#) & [C-405/15 P](#), Shower drains, EU:C:2017:720, § 93).

Classification serves exclusively administrative purposes, in particular allowing third parties to search the registered Community design databases (Article 3(2) CDIR).

Applicants do not themselves have to classify the products in which their design is intended to be incorporated or to which it is intended to be applied (Article 36(3)(d) CDR). This is, however, highly recommended in order to speed up the registration procedure (see [paragraph 6.2.3](#) below).

The considerations that follow only refer to single design applications. As far as multiple design applications are concerned, the 'unity of class' requirement applies (see [paragraph 7.2.3](#) below).

#### 6.1.4.2 The Locarno Classification and DesignClass

The Locarno Classification is an international classification for industrial designs. It exists in two official languages, namely French and English. Its structure and contents are adopted and amended by the Committee of Experts from the countries party to the Locarno Agreement. The Classification is administered by the World Intellectual Property Organization (WIPO).

The Office's [DesignClass](#) web tool, based on the Locarno Classification, helps users search the harmonised product indications database for product indications that best match the products for which they want to register a design. The harmonised product indications database follows the same structure of classes and subclasses as the Locarno Classification. It contains not only the Locarno product indications but also many more that are accepted by the EU Member State IP offices and the Office. The database is updated regularly with every new edition of the Locarno Classification approved by the Committee of Experts.

To speed up and simplify the registration procedure, it is highly recommended that products be indicated using the terms listed in DesignClass.

Using the terms listed in DesignClass obviates the need for translations and thus prevents long delays in the registration procedure. Using these product terms whenever possible will improve the transparency and searchability of the registered Community design databases.

#### 6.1.4.3 How to indicate products

More than one product can be indicated in the application.

When more than one product is indicated in the application, the products do not have to belong to the same class of the Locarno Classification, unless several designs are combined in a multiple application (Article 37(1) CDR; Article 2(2) CDIR; see [paragraph 7.2.3](#) below).

Each class and subclass of the Locarno Classification and DesignClass has a 'heading'. The class and subclass headings give a general indication of the fields to which the products belong.

In any event, the product(s) must be indicated in such a way as to allow classification in both the relevant class and subclass of the Locarno Classification (Article 1(2)(c) CDIR).

The use of terms listed in the heading of a given class of the Locarno Classification is not per se excluded, but it is not recommended. Applicants should **not** choose generic terms referred to in the heading of the relevant class (e.g. *articles of clothing and haberdashery* in Class 2), but instead select terms listed in the heading of the subclass (e.g. *garments* in subclass 02-02) or more specific terms from among those listed in the subclasses of the class in question (e.g. *jackets* in subclass 02-02).

Where the product indication does not allow classification in a subclass, the examiner will determine the relevant subclass by reference to the product disclosed in the graphical representation (see [paragraph 6.2.3.1](#) below). For example, where an application contains as a product indication the term *furnishing* in Class 6 of the Locarno Classification, the examiner will assign a subclass by taking account of the design itself insofar as it makes clear the nature of the product, its intended purpose or its function. If the design clearly discloses the appearance of a bed, the examiner will assign the subclass 06-02 and change the product indication to *beds*.

The use of adjectives in product indications is not per se excluded, even if such adjectives are not part of the alphabetical list of products of the Locarno Classification or DesignClass (e.g. *electric tools for drilling* in subclass 08-01, or *cotton pants* in subclass 02-02). However, it may cause delays in processing the application where a translation of the adjective into all the EU languages is required.

#### 6.1.4.4 *Ex officio* change of indication

##### Product terms not listed in the Locarno Classification or DesignClass

Where an applicant uses terms that are not in the Locarno Classification or DesignClass, the examiner will, in straightforward cases, substitute *ex officio* the wording used by the applicant with an equivalent or more general term listed in the Locarno Classification or DesignClass. The purpose of this is to avoid having to translate terms into all the EU languages, which would result in delays in processing the application.

For instance, where an applicant chooses the term *running trainers* (assuming it is not listed in the Locarno Classification or DesignClass) to indicate the products in which the design will be incorporated, the examiner will change this indication to *running shoes* (assuming it is listed therein).

Even though the product indication does not affect the scope of protection of a Community design as such, the examiner will refrain from replacing the terms chosen by the applicant with more specific terms.

##### Products and their parts

Where a design represents the appearance of one part of a product, and that product as a whole is indicated in the application (e.g. an application for the design of a knife handle specifies that the products in which the design will be incorporated are *knives* in subclass 08-03), the examiner will replace that product indication by the indication *product(s) X (part of -)*, provided both the part in question and the product as a whole belong to the same class of the Locarno Classification.

Where a design represents the appearance of a product as a whole, but only a part of that product is indicated in the application (e.g. an application for the design of a knife specifies that the products in which the design will be incorporated are *knife handles*), the examiner will raise an objection and will suggest either disclaiming the part not indicated (in which case a new filing date must be accorded) or replacing that product indication by the product term for the whole product (in which case the original filing



date may be kept but the design's subject matter of protection will remain to be determined on the basis of the representation as filed). If the applicant does not reply within the time limit, the examiner will *ex officio* replace the applicant's product indication with the suggestion made.

Where a design represents a set of products, and these products are indicated in the application (e.g. an application for the design of a set of dishes specifies that the products in which the design will be incorporated are *dishes* in subclass 07-01), the examiner will replace that indication by *product(s) X (set of -)*.

#### Ornamentation

Where the design represents ornamentation for a given product, and only that product as a whole is indicated in the application, the examiner will replace that product indication by the indication *product(s) X (ornamentation for -)*. The product will thus be classified under Class 32-00 of the Locarno Classification.

Where the product indication is *ornamentation* and the design does not limit itself to representing ornamentation but also discloses the product to which the ornamentation is applied, or part of that product, without its contours being disclaimed, the examiner will raise an objection and will suggest either disclaiming that part (in which case a new filing date must be accorded) or replacing the indication *ornamentation* with the product indication for the product disclosed (in which case the original filing date may be kept but the subject matter for which the design is protected will have to be determined on the basis of the representation as filed). If the applicant does not reply within the time limit set, the product indication will be changed *ex officio* in accordance with the Office's proposal.

This may lead to an objection where a multiple application combines a number of such designs applied to products that belong to different classes of the Locarno Classification (see [paragraph 7.2.3](#) below).

The same reasoning applies to the following product indications in Class 32 of the Locarno Classification: *graphic symbols and logos, surface patterns*.

#### Obvious mismatch

Since one of the main objectives of the product indication and classification is to enable the Community Designs Register to be searchable by third parties, where the product indication clearly does not match the product as disclosed in the representation of the design, the examiner will replace that product indication with the correct one.

#### Notification of the *ex officio* change of indication

Provided there is no deficiency, the examiner will register the Community design(s) and notify the holder of the registration of the *ex officio* change of product indication.

Where the holder objects to such *ex officio* change, it can apply for correction of the corresponding entry in the Register (see [paragraph 11.1](#) below) and request that the original terms used in the application be maintained, provided there are no issues concerning the clarity and precision of these terms or their classification (Article 20 CDIR).

### **6.1.5 Long lists of products**

More than one product can be indicated in an application.

However, in order to ensure that the Community Designs Register remains searchable, where the product indication contains more than five products the examiner will suggest that the applicant limit the number of products to a maximum of five and select products accordingly; the examiner may also suggest which products should be selected.

If, within the time limit indicated in the examiner's communication, the applicant expresses its wish to maintain the original list of products, the examination will proceed on the basis of that list. If the applicant does not respond within the time limit or expressly agrees with the examiner's suggestion, the examination will proceed on the basis of the product indication as suggested by the examiner.

### **6.1.6 Objections to product indications**

Where the examiner raises an objection, the applicant will be given 2 months to submit its observations and remedy the deficiencies noted (Article 10(3) CDIR).

The examiner may invite the applicant to specify the nature and purpose of the products in order to allow proper classification, or may suggest product terms from DesignClass in order to assist the applicant.

If the deficiency is not remedied within the time limit, the application will be rejected (Article 10(4) CDIR).

#### **6.1.6.1 No product indication**

An objection will be raised where the application gives no indication of the products concerned (Article 36(2) CDR). However, if an indication can be found in the description or in the priority document, the examiner will record this as the product indication (21/03/2011, [R 2432/2010-3](#), KYLKROPP FÖR ELEKTRONIKBÄRARE, § 14).

#### **6.1.6.2 Deficient product indication**

As noted above, the indication of products must be worded in such a way as to indicate clearly the nature of the products and enable each product to be classified in accordance with the Locarno Classification (Article 3(3) CDIR). Therefore, the examiner will also object to the product indication if it does not enable each product to be classified in only one class and subclass of the Locarno Classification.

This will be the case where the indication is too vague or ambiguous to allow the nature and purpose of the products in question to be determined, for example, *merchandise, novelty items, gifts, souvenirs, home accessories, electric devices*, etc.

This will also be the case where the indication concerns a service rather than a product, for example, *sending or processing of information*.

## 6.2 Optional elements

An application may contain a number of optional elements, as listed in Article 1(1)(f) and (g) CDR and Article 1(2) CDR, that is,

- a priority or exhibition priority claim;
- a description;
- an indication of the Locarno Classification of the products contained in the application;
- the citation of the designer(s);
- a request for deferment.

### 6.2.1 Priority and exhibition priority

#### 6.2.1.1 Priority

##### General principles

An application for a Community design may claim the priority of one or more previous applications for the same design or utility model in or for any state party to the Paris Convention or to the Agreement establishing the World Trade Organization, or in or for another state with which there is a reciprocity agreement (Article 41 CDR; Article 8 CDR). This ‘Convention priority’ is of 6 months from the date of filing of the first application.

The effect of the right of priority is that the date of priority counts as the date of filing of the application for a registered Community design for the purpose of Articles 5, 6, 7 and 22, Article 25(1)(d) and Article 50(1) CDR (Article 43 CDR).

If the priority of the same previous application is claimed for all designs of a multiple application, the ‘Same priority for all designs’ box should be ticked in the (paper) application form.

Any filing that is equivalent to a standard national filing under the domestic law applicable to it will be recognised as giving rise to the right of priority. A standard national filing means any filing that is suitable for establishing the date on which the application was filed in the country concerned, whatever the subsequent outcome of that application (Article 41(3) CDR).

The Office is a participating office in WIPO DAS, which is an electronic system allowing priority documents and similar documents to be securely exchanged between participating IP offices.

The system enables applicants and offices to meet the requirements of the Paris Convention for the certification of priority documents, allowing them to be exchanged in an electronic environment.

As **Office of Second Filing**, the Office accepts priority claims by way of reference in the fields provided for that purpose, namely, the file number, filing date and country of the previous application together with the WIPO DAS access code. This allows the priority document registered in WIPO DAS to be requested by the Office for immediate download.

Priority may be claimed either when filing the Community design application or within 1 month of the filing date. During this month, the applicant must submit the declaration of priority and indicate the file number as well as the date on which, and the country in which, the previous application was made (Article 8(2) CDIR).

Where there is no indication of the claim in the application, the submission of priority documents, or WIPO DAS access code, within 1 month of the filing date will be construed as a priority claim.

Unless it is expressly indicated in the application that a priority claim will be made subsequently, the application will be examined without delay and, if no deficiency is found, will be registered without waiting 1 month for any potential declaration of priority. If a declaration of priority is validly filed after registration of the Community design application, a corresponding entry will subsequently be made in the Register.

#### Formal requirements

At the examination stage, the Office will only examine whether all **formal requirements** are met.

The formal requirements are:

- priority claim must be filed together with the Community design application or within 1 month of the filing date (Article 8(2) CDIR);
- file number, filing date and country of previous application must be indicated when claiming priority (Article 1(1)(f) CDIR);
- priority documents must be submitted:
  - by providing the WIPO DAS access code at the time of filing via e-filing or within 3 months of either the filing date or, as the case may be, receipt of the priority claim;
  - **or** by submitting a copy of all priority documents\* within 3 months of either the filing date or, as the case may be, receipt of the priority claim along with, where applicable, translations thereof (Article 8 CDIR).

\* The priority document must consist of a copy of the entire previous application or registration, emanating from the authority that received it, stating the filing date of that application. The priority document may be filed in the form of an original or as an accurate photocopy. If the original document contains a representation of the design in colour, the photocopy must also be in colour (Decision No [EX-20-7](#) of the Executive Director of the EUIPO of 11 September 2020 on the formal requirements of priority claims relating to registered Community designs).

Where the priority of a previous registered Community design is claimed, the applicant must indicate the number of the previous application and its date of filing. No additional information or document is required (Decision No [EX-20-7](#) of the Executive Director of the EUIPO of 11 September 2020 on the formal requirements of priority claims relating to registered Community designs).

The Office will then publish the priority claim 'as claimed', meaning that the Office will not confirm the validity of the priority claim.

#### Language of previous application

If the language of the previous application is not one of the languages of the European Union, the examiner will invite the applicant to file a translation of the first or second language of the RCD application within 2 months (Article 42 CDR).

For the purpose of examining the formal requirements, the examiner will only verify that the information allowing the examiner to check the file number, date and country of the previous application has been translated. However, the applicant must also file a translation of the remaining parts concerning the substantive requirements which, where necessary, will be examined during *inter partes* proceedings; this is also in the interests of third parties when inspecting the validity of the priority claim.

#### Formal priority requirements not satisfied

At the filing stage, the Office will limit itself to verifying whether the formal requirements listed above relating to a priority claim are satisfied (Article 45(2)(d) CDR).

Where remediable deficiencies are found, the examiner will request that the applicant remedy them within 2 months.

If the deficiencies are not remedied in due time or cannot be remedied, the Office will inform the applicant of the rejection of the priority claim and of the possibility of requesting a formal (i.e. appealable) decision on that rejection (Article 46(1) and (4) CDR; Article 40(2) CDIR).

If the deficiencies that are not remedied concern only some of the designs contained in a multiple application, the priority claim will be rejected in respect only of the individual designs concerned (Article 10(8) CDIR).

#### Substantive requirements

The **substantive requirements** to be met under Article 41 CDR for a priority claim to be considered valid will be examined not at the filing stage but, where necessary, during *inter partes* proceedings, and will be based on the copy of the priority documents submitted. **It is, therefore, the responsibility of the Community design applicant to submit a copy of the priority documents and, where applicable, translations thereof at the filing stage**, to allow the priority claim to be examined substantively when required during *inter partes* proceedings.

The requirements that refer to the substance of the priority claims are:

- previous application must be a first filing;
- previous application must concern a design or a utility model;
- Community design must relate to the 'same design or utility model';

- proprietor must be the same;
- priority must be claimed within 6 months of filing the first application;
- previous application must have been filed in a country where a right of priority can arise.

A priority claim in respect of the contested RCD will be examined *ex officio* by the Office during invalidity proceedings when the outcome of the invalidity case depends on whether priority was validly claimed.

If the priority claim does not satisfy all of the substantive requirements, the holder concerned will be invited to make observations within the time limit set by the Office. If the validity of the priority claim cannot be verified, the priority cannot be taken into account for the purpose of the proceedings concerned. The decision on the priority claim can only be appealed together with the final decision on the invalidity proceedings.

*The previous application is a first filing*

As a matter of principle, the previous application must be a first filing. The Office will therefore check that the priority document does not refer to priority being claimed in respect of an even earlier application.

As an exception, a subsequent application for a design that was the subject of a previous first application and has been filed in or for the same state, will be considered as a first application for the purpose of determining priority, provided that, at the date of filing of the subsequent application, the previous application had been withdrawn, abandoned or refused without being open to public inspection and without leaving any rights outstanding, and had not served as a basis for claiming priority. The previous application may not thereafter serve as a basis for claiming a right of priority (Article 41(4) CDR).

*The previous application concerns a design or a utility model*

The priority of a previous design or utility model application may be claimed, including that of a previous Community design or an international design registration.

Many national laws do not provide for the protection of utility models, for example the laws of the United States of America. In the European Union, utility models can be registered in, inter alia, the Czech Republic, Denmark, Germany, Spain, Italy, Hungary, Austria, Poland, Portugal, Slovakia and Finland. Utility models can also be registered in Japan.

A priority claim based on a previous **patent** application will in principle be rejected. However, the priority of an international application filed under the Patent Cooperation Treaty (PCT) can be claimed, since Article 2 of the PCT defines the term 'patent' in a broad sense that covers utility models.

A priority claim may only be based on a previous application filed with a national office which protects designs as design patents instead of registered designs (for example, the United States Patent and Trademark Office - USPTO) if the subject matter of the previous application relates to a 'design patent', not a 'patent'.

*The Community design relates to the 'same design or utility model'*

The subject matter of the previous application must be identical to that of the corresponding Community design, without the addition or deletion of any features.

According to Article 5(2) CDR, the subject matter is considered to be identical if the Community design and the previous application for a design right or a utility model differ only in details that can be qualified as 'immaterial'.

The identity of the subject matter may not be affected when, on account of diverging formal requirements, the representation of the design as shown in the previous application has to be altered in order to be filed as a Community design (15/05/2013, ICD No 8 683).

*The proprietor is the same*

Priority can be claimed by the applicant of the first application or its successor in title. In the latter case, the first application must have been transferred prior to the filing date of the Community design application, and documentation to this effect must be submitted.

The right of priority as such may be transferred independently of the first application. Priority can therefore be accepted even if the holders of the Community design and the previous application are different, provided that evidence of assignment of the priority right is submitted. In this case, the execution date of the assignment must be prior to the filing date of the Community design application.

Subsidiary or associated companies of the applicant are not considered to be the same legal entity as the Community design applicant itself.

*Priority is claimed within 6 months of filing the first application*

The Office will examine whether the date of filing allocated to the Community design is within 6 months of the filing date of the first application. Community design applicants should note that the date of **filing** allocated by the Office may not always correspond to the date of **receipt** of the Community design application.

The priority right claimed must always be a previous application, which, for this very reason, cannot bear the same date as the Community design application.

*The previous application was filed in a country where a right of priority can arise*

The 'Convention priority' right is a right limited in time, which is triggered by the first regular filing of a design. A regular national filing is any filing that is 'adequate to establish the date on which the application was filed in the country concerned, whatever the subsequent fate of the application' (Article 4A(3) Paris Convention). It may be claimed during the 6 months following the first filing, provided the country of first filing was a party to the Paris Convention or to the Agreement establishing the World Trade Organization (WTO), or a country with a reciprocity agreement (see [Article 34\(5\) to \(7\) EUTMR](#) – publication on reciprocity by the Commission).

The states and other entities mentioned below, inter alia, are not members of any of the relevant conventions. Nor do they benefit from reciprocity agreements. Therefore, priority claims based on filings in these countries will be **rejected**.

Independent states (not party to the Paris Convention, WTO or reciprocity agreement):

Afghanistan (AF)

Aruba (AW)

Cook Islands (CK)

Eritrea (ER)

Ethiopia (ET)

Kiribati (KI)

Marshall Islands (MH)

Micronesia (FM)

Nauru (NR)

Palau (PW)

Somalia (SO)

Tuvalu (TV)

Other entities (not party to the Paris Convention, WTO or reciprocity agreement):

Abkhazia (GE-AB)

American Samoa (AS)

Anguilla (AI)

Bermuda (BM)

Cayman Islands (KY)

Falkland Islands (FK)

Guernsey (GG)

Isle of Man (IM)

Jersey (JE)

Montserrat (MS)

Pitcairn Islands (PN)

Saint Helena (SH)

Turks and Caicos Islands (TC)

British Virgin Islands (VG)

#### 6.2.1.2 Exhibition priority

##### General principles

The effect of exhibition priority is that the date on which the design was displayed at an officially recognised exhibition is deemed to be the date of filing of the application for an RCD for the purposes of Articles 5, 6, 7 and 22, Article 25(1)(d) and Article 50(1) CDR (Article 43 CDR).

The applicant can claim exhibition priority within 6 months of the first display. Evidence of the display must be filed (Article 44(1) and (2) CDR).



Exhibition priority cannot extend the 6-month Convention priority period (Article 44(3) CDR).

#### Claiming exhibition priority

Similar to Convention priority (see [paragraph 6.2.1.1](#)), exhibition priority can be claimed either when filing an RCD application or subsequently. Where the applicant wishes to claim exhibition priority after having filed an application, the declaration of priority, indicating the name of the exhibition and the date of first display of the product, must be submitted within 1 month of the filing date (Article 9(2) CDR).

The applicant must, within 3 months of the filing date or receipt of the declaration of priority, provide the Office with a certificate issued at the exhibition by the responsible authority. This certificate must state that the design was disclosed at the exhibition, specify the opening date of the exhibition and, where first public use did not coincide with the opening date of the exhibition, the date of first public use. The certificate must be accompanied by identification of the actual disclosure of the product in which the design is incorporated, duly certified by the authority (Article 9(1) and (2) CDR).

Priority can only be granted where an RCD application is filed within 6 months of first display at an exhibition recognised for this purpose, namely a world exhibition within the meaning of the Convention relating to International Exhibitions signed in Paris on 22/11/1928. These exhibitions are rare and Article 44 CDR does not cover display at other, national or international, exhibitions. The exhibitions can be found on the website of the Paris 'Bureau International des Expositions': <http://www.bie-paris.org/site/en/>.

As is the case for Convention priority, the substantive requirements for exhibition priority will not be examined at the filing stage but during *inter partes* proceedings, where necessary, and will be restricted to the extent of the *inter partes* proceedings (see [paragraph 6.2.1.1, Priority](#)).

## **6.2.2 Description**

The application may include a description not exceeding 100 words explaining the representation of the design or the specimen (see [paragraph 3.3.5](#) above). The description must relate only to those features that appear in the reproductions of the design or the specimen. It may not contain statements concerning the purported novelty or individual character of the design or its technical value (Article 1(2)(a) CDR).

Apart from these requirements, the Office will not examine whether the description accords with the representation of the design or the specimen.

The description does not affect the scope of protection of a Community design as such (Article 36(6) CDR; 21/06/2017, [T-286/16](#), Toilettensitze (Teil von -), EU:T:2017:411, § 44). It cannot substitute visual disclaimers to exclude features from protection (see [paragraph 5.4](#) above).

The description may, however, clarify the nature or purpose of some features of the design in order to avoid a possible objection. For instance, where different views of the same design display different colours, thus raising doubts as to consistency between

them (see [paragraph 5.2.3](#) above), the description may explain that the colours of the design change when the product in which this design is incorporated is in use.

Descriptions submitted after the date of filing of the application will not be accepted.

The Register will include a mention that a description has been filed, but the description as such will not be translated or published. However, the description will remain part of the administrative file of the application and will be open to public inspection by third parties under the conditions set out in Article 74 CDR and Articles 74 and 75 CDIR.

## 6.2.3 Indication of the Locarno Classification

### 6.2.3.1 General principles

The applicant may itself identify the classification, in accordance with the Locarno Classification, of the products indicated in the application (see [paragraph 6.1.4](#) above).

If the applicant provides a classification, the products must be grouped in accordance with the classes of the Locarno Classification, each group being preceded by the number of the relevant class, and presented in the order of the classes and subclasses (Article 3 CDIR).

Use of the harmonised database of product indications (Locarno product indications and those accepted by EU-based IP offices and the EUIPO), which can be consulted through [DesignClass](#) when filing an RCD application online, will accelerate the examination procedure. The harmonised database of product indications is integrated into the EUIPO's design e-filing application.

Since classification is optional, no objection will be raised if the applicant does not submit a classification or does not group or sort the products as required, provided that no objection is raised with regard to the indication of products ([paragraph 6.1.6](#) above). If no such objection is raised, the examiner will classify the products *ex officio* according to the Locarno Classification.

Where the applicant has indicated only the main class and no subclass, the examiner will assign the subclass that appears suitable in view of the design shown in the representation. For instance, where a design application indicates *packaging* in Class 9 of the Locarno Classification, and the design represents a bottle, the examiner will assign subclass 09-01 (the heading of which is *bottles, flasks, pots, carboys, demijohns, and containers with dynamic dispensing means*).

Where the applicant has given the wrong classification, the examiner will assign the correct one *ex officio*.

Products that combine different elements so as to perform more than one function will be classified in as many classes and subclasses as the number of purposes served. For instance, the product indication *refrigerating boxes with radios and CD players* will be classified under Classes 14-01 (*equipment for the recording or reproduction of sounds or pictures*), 14-03 (*communications equipment, wireless remote controls and*

*radio amplifiers*) and 15-07 (*refrigeration machinery and apparatus*) of the Locarno Classification.

### 6.2.3.2 Multiple applications and the requirement of 'unity of class'

If the same product indication applies to all designs contained in a multiple application, the relevant box 'Same indication of product for all designs' should be ticked in the (paper) application form and the field 'Indication of product' left blank for the subsequent designs.

Where several designs other than ornamentation are combined in a multiple application, the application will be divided if the products in which the designs are intended to be incorporated or to which they are intended to be applied belong to more than one class of the Locarno Classification (Article 37(1) CDR; Article 2(2) CDIR; see [paragraph 7.2.3](#) below).

## 6.2.4 Citation of the designer(s)

The application may include:

1. a citation of the designer(s), or
2. a collective designation for a team of designers, or
3. an indication that the designer(s) or team of designers has/have waived the right to be cited (Article 18 CDR; Article 1(2)(d) CDIR).

The citation, the waiver and an indication regarding the designer(s) are merely optional and are not subject to examination.

If the designer or the team of designers is the same for all designs applied for in a multiple application, this should be indicated by ticking the box 'Same designer for all designs' in the (paper) application form.

Since the right to be cited as the designer is not limited in time, the designer's name can also be entered into the Register after registration of the design (Article 69(2)(j) CDIR).

## 6.2.5 Request for deferment

### 6.2.5.1 General principles

The applicant for a registered Community design may, **when filing the application**, request that its publication be deferred for **30 months** from the date of filing or, if a priority is claimed, from the date of priority (Article 50(1) CDR).

Where no deficiency is found, the Community design will be registered. The information published in Part A.2 of the *Community Designs Bulletin* consists of the file number, date of filing, date of entry in the Register, registration number, name and address of the holder, and name and business address of the representative (if applicable). No

other particulars, such as the representation of the design or the indication of products, are published (Article 14(3) CDIR).

Nevertheless, third parties may inspect the entire file if they have obtained the applicant's prior approval or if they can establish a legitimate interest (Article 74(1) and (2) CDR).

In particular, there is a legitimate interest where an interested person submits evidence that the holder of the registered Community design whose publication is deferred has taken steps with a view to invoking the right against them.

No registration certificate will be made available as long as the publication of a design is deferred. However, the holder of the design registration subject to deferment may request a certified or uncertified extract from the register, containing the representation of the design or other particulars identifying its appearance (Article 73(b) CDIR), for the purpose of invoking its rights against third parties (Article 50(6) CDR). For more information on obtaining certified extracts from the register, see the Guidelines, [Part E, Register Operations, Section 5, Inspection of Files](#).

The procedure described in this section does **not** apply to international registrations designating the European Union (see [paragraph 12](#) below).

#### 6.2.5.2 Request for deferment

Deferment of publication must be requested in the application (Article 50(1) CDR). Subsequent requests will not be accepted, even if received on the same day.

Applicants should be aware that designs can be registered and accepted for publication within two working days and even sometimes on the day that the application is received (see [paragraph 2.7.1](#) above). If, by mistake, an application does not contain a request for deferment, the application should be withdrawn in order to prevent publication. Given the speed of the registration and publication processes, this should be done **immediately** after filing. The applicant should also contact an examiner on the day of the withdrawal.

A request for deferment of publication may concern only some of the designs of a multiple application. In this case, the designs to be deferred must be clearly identified by ticking the box 'Request for deferment of publication' on the (paper) form or the box 'Publication to be deferred' (e-filing) for each individual design.

The applicant must pay a fee for deferment of publication along with the registration fee (see [paragraph 8](#) below). Payment of the publication fee is optional at the filing stage.

#### 6.2.5.3 Request for publication

When applying, or at the latest **3 months before the 30-month period expires**, the applicant must comply with what are known as the 'publication request requirements' (Article 15 CDIR), by:

- paying the publication fee for the design(s) to be deferred (see [paragraph 8](#));

- in cases where a representation of the design has been replaced by a specimen in accordance with Article 5 CDIR (see [paragraph 3.3.5](#) above), filing a representation of the design in accordance with Article 4 CDIR (see [paragraph 5](#) above);
- in the case of a multiple registration, clearly indicating which of the designs among those identified for deferment are to be published or surrendered, or for which designs deferment is to be continued, as the case may be.

Where the Community design holder notifies the Office, **any time before 27 months have expired**, of its wish to have the design(s) published ('request for anticipated publication'), it must specify whether publication should take place as soon as technically possible (Article 16(1) CDIR) or when the 30-month deferment period expires. Where there is no specific request from the applicant, the designs will be published when the deferment period expires.

If the holder, despite a previous request for publication, decides that the design should not be published after all, it must submit a written request for surrender well before the design is due to be published. Any publication fees already paid will not be refunded.

#### 6.2.5.4 Observation of time limits

Community design holders should be aware that the Office will not issue reminders regarding the expiry of the 27-month period before which the publication request requirements must be complied with. It is therefore the applicant's responsibility to make sure that the time limits are observed.

Particular attention must be paid where a priority date was claimed either at the time of filing or afterwards, since this priority date will determine the time limits applicable to deferment. Moreover, the time limits applicable to deferment may differ for each of the designs of a multiple registration, if different priority dates are claimed for each individual design.

Where the time limit for complying with 'the publication request requirements' is not met, thus resulting in a loss of rights, the Community design holder may file a request for *restitutio in integrum* (Article 67 CDR; see also the Guidelines, [Part A, General Rules, Section 8, Restitutio in Integrum](#)).

#### 6.2.5.5 Deficiencies

##### Deficiencies at the examination stage

If the information contained in the application is contradictory (e.g. the deferment fee has been paid, but the applicant has not ticked the box 'Request for deferment of publication') or inconsistent (e.g. the amount of the deferment fees paid for a multiple application does not correspond to the number of designs to be deferred), the examiner will issue a deficiency letter asking the applicant to confirm that deferment is requested and, where applicable, for which specific design(s) of a multiple application, and/or to pay the corresponding fees.

##### Deficiencies relating to the 'publication request requirements'

If, 27 months after the filing date or priority date of the Community design registration, the holder has failed to comply with the 'publication request requirements', the examiner will issue a deficiency letter giving 2 months for the deficiencies to be remedied (Article 15(2) CDR).

Where a deficiency concerns the payment of publication fees, the applicant will be requested to pay the correct amount plus fees for late payment (i.e. EUR 30 for a design and, in the case of a multiple application, 25 % of the fees for publication for each additional design; Article 15(4) CDR; Articles 8 and 10 of the Annex to the CDR).

Applicants should be aware that the time limit set by the examiner cannot be extended beyond the 30-month period of deferment (Article 15(2) CDR).

If deficiencies are not remedied within the set time limit, the registered Community design(s) to be deferred will be deemed from the outset not to have had the effects specified in the CDR (Article 15(3)(a) CDR).

The examiner will notify the holder accordingly, after the 30-month period of deferment has expired.

In the case of a 'request for anticipated publication' (see [paragraph 6.2.5.3](#) above), failure to comply with the publication request requirements will result in the request being deemed not to have been filed (Article 15(3)(b) CDR). The publication fee will be refunded if it has already been paid. Where there are still more than 3 months before the 27-month period expires, the holder may, however, submit another request for publication.

Where the deficiency concerns a payment that is insufficient to cover the publication fees for all the designs that are to be deferred in a multiple application, including any fees for late payment, the designs not covered by the amount paid will be deemed from the outset not to have had the effects specified in the CDR. Unless the holder made it clear which designs were to be covered by the amount paid, the examiner will take the designs in consecutive numerical order (Article 15(4) CDR).

#### Publication after deferment

Where there are no deficiencies or deficiencies have been overcome in due time, the registration will be published in Part A.1 of the *Community Designs Bulletin*.

The holder may request that only some of the designs of a multiple application are published.

Mention will be made in the publication of the fact that deferment was originally applied for and, where applicable, that a specimen was initially filed (Article 16 CDR).

## 7 Multiple Applications

### 7.1 General principles

A multiple application is a request for the registration of more than one design within the same application. Each of the designs contained in a multiple application or registration is examined and dealt with separately. In particular, each design may, separately, be enforced, be licensed, be the subject of a right *in rem*, a levy of execution or insolvency proceedings, be surrendered, renewed or assigned, be the subject of deferred publication or be declared invalid (Article 37(4) CDR).

Multiple applications are subject to specific registration and publication fees, which vary in proportion to the number of designs (see [paragraph 8](#) below).

### 7.2 Formal requirements applying to multiple applications

#### 7.2.1 General requirements

All the designs in a multiple application must have the same owner(s) and the same representative(s) (if any).

The number of designs contained in a multiple application is unlimited. The designs need not be related to one another or be otherwise similar in terms of appearance, nature or purpose. The designs must, however, meet the 'unity of class' requirement (see [paragraph 7.2.3](#), below).

The number of designs should not be confused with the 'number of views' that represent the designs (see [paragraph 5.1](#) above).

Applicants must number the designs contained in a multiple application consecutively, using Arabic numerals (Article 2(4) CDIR).

A suitable representation of each design contained in a multiple application must be provided (see [paragraph 5](#) above) and an indication given of the product in which the design is intended to be incorporated or to be applied must be given (Article 2(3) CDIR, see [paragraph 6.1.4](#) above).

#### 7.2.2 Separate examination

Each of the designs contained in a multiple application is examined separately. If a deficiency concerning some of the designs contained in a multiple application is not remedied within the time limit set by the Office, the application will be refused only insofar as those designs are concerned (Article 10(8) CDIR).



The decisions on the registration or refusal of the designs contained in a multiple application will all be taken at the same time.

Even if some of the designs in a multiple application already comply with both the substantive and formal requirements, they will not be registered until any deficiencies affecting other designs have been remedied or the designs in question have been refused by the decision of an examiner.

## 7.2.3 The 'unity of class' requirement

### 7.2.3.1 Principle

As a rule, **all the product(s) indicated for the designs** contained in a multiple application **must be classified in only one of the 32 Locarno classes**.

As an exception, the indication *ornamentation* or *product(s) X (ornamentation for -)* in Class 32-00 can be combined with indications of products belonging to another Locarno class.

### 7.2.3.2 Products other than ornamentation

The products indicated for each design in a multiple application may differ from those indicated for others.

However, except in cases of *ornamentation* (see [paragraph 7.2.3.3](#) below), any products that are indicated for each and every design of a multiple application must belong to the same class of the Locarno Classification (Article 37(1) CDR; Article 2(2) CDIR). This 'unity of class' requirement is considered to be complied with even if the products belong to different subclasses of the same class of the Locarno Classification.

For instance, a multiple application is acceptable if it contains one design with the product indication *motor vehicles* (Class 12, subclass 08) and one design with the product indication *vehicle interiors* (Class 12, subclass 16). This is an example of two designs in different subclasses but in the same class, namely Class 12 of the Locarno Classification.

An objection would, however, be raised if, in the above example, the products indicated were *motor vehicles* (Class 12, subclass 08) and *lights for vehicles*, since the second term belongs to Class 26, subclass 06 of the Locarno Classification. The examiner would then require the multiple application to be divided, as explained under [paragraph 7.2.3.4](#) below.

A multiple application cannot be divided unless there is a deficiency affecting the 'unity of class' requirement (Article 37(4) CDR).



### 7.2.3.3 Ornamentation

Ornamentation is a decorative element capable of being applied to the surface of a variety of products. It can take the form of a pattern, including a moulding, engraving or carving in which the design stands out from a flat surface.

Although ornamentation is, in itself, a product within the meaning of the Locarno Classification (Class 32), its primary purpose is to constitute one of the features of other products. Therefore, representations of ornamentation should not include the product to which it will be applied, or they should disclaim the product (see [paragraph 5.4](#) above).

A multiple application can therefore combine designs for ornamentation with designs for products such as those to which the ornamentation will be applied, provided that all the products belong to the same class of the Locarno Classification.

For some designs, the indication *ornamentation* or *product(s) X (ornamentation for)* in Class 32 of the Locarno Classification is neutral and therefore ignored for the purpose of examining whether the product indication for the remaining designs meets the ‘unity of class’ requirement.

The same reasoning applies to the following product indications in Class 32 of the Locarno Classification: *graphic symbols*, *logos* and *surface patterns*.

For example, a multiple application is acceptable if it combines designs for *ornamentation* or *china (ornamentation for)* in Class 32 with designs representing pieces of a tea set for *china* in Class 7, subclass 01. However, if, in addition, *linen (table -)* were indicated as a product for one of the designs in the same multiple application, an objection would be raised as this product belongs in Class 6, subclass 13 of the Locarno Classification, that is, a different class.

Where the applicant has indicated the product as *ornamentation* or *product(s) X (ornamentation for)*, the examiner will prima facie examine whether it is really for ornamentation by looking at the design in question. Where the examiner agrees that it is for ornamentation, the product will be classified in Class 32.

Where the examiner does not agree that the design is for ornamentation, the examiner will replace that product indication with the correct one on the grounds of an obvious mismatch between the products indicated and the design (see [paragraph 6.1.4.4](#) above).

Where the representation of the design is not limited to ornamentation itself but also discloses the product to which such ornamentation is applied, without the contours of this product being disclaimed, the examiner will raise an objection and will suggest replacing the indication *ornamentation* with the product indication for the product disclosed and the classification must be amended accordingly (see [paragraph 6.1.4.4](#) above).

This may lead to an objection where a multiple application combines a number of such designs applied to products that belong to different classes of the Locarno Classification.

#### 7.2.3.4 Deficiencies

Where a multiple application combines a number of designs applied to products that belong to different classes, or to more than one class of the Locarno Classification, a deficiency will be raised.

For example, let us assume that three designs representing cars are combined in one multiple application, and the product indication for each design is *motor cars* (subclass 12-08) and *scale models* (subclass 21-01).

The examiner will issue an objection and request the applicant to:

- delete some of the product indications so that the remaining products can be classified in only one Locarno class; or
- divide the application into two multiple applications for each of the Locarno classes concerned, and pay the corresponding additional fees; or
- divide the application into three single applications for each design concerned, and pay the corresponding additional fees.

In some cases, it will not be possible to delete product indications, for example where a given product must be classified in two or more classes on account of the plurality of purposes it serves (see [paragraph 6.2.3.1](#) above).

The applicant will be invited to comply with the examiner's request within 2 months and pay the total amount of fees for all applications resulting from the division of the multiple application or to delete some products in order to meet the 'unity of class' requirement.

The total amount to be paid is calculated by the examiner and notified to the applicant in the examination report. The examiner proposes the most cost-effective option between dividing the multiple application into as many applications as Locarno classes concerned or as many applications as designs concerned.

Where the applicant does not remedy the deficiencies in due time, the multiple application is refused **in its entirety**.

## 8 Payment of Fees

### 8.1 General principles

RCD applications are subject to various fees, which the applicant must pay **at the time of filing** (Article 6(1) CDIR), including the registration fee and the publication fee or, where the application includes a request for deferment of the publication, the deferment fee.

Although the payment of the fee is not linked to the establishment of a filing date (Article 38 CDR), the Office will only begin examination of the filing date requirements once the fee has been paid.

In the case of multiple applications, additional registration, publication or deferment fees must be paid for each additional design. If payment was not made when filing the application, late payment fees must also be paid.

In the case of deferment, applicants can, when filing, choose to pay not only the registration and deferment fee, but also the publication fee.

For the fee payable with respect to an international application designating the European Union, see [paragraph 12.1.2.4](#). For more information on fees and payments in general, see the Guidelines, [Part A, General rules, Section 3, Payment of fees, costs and charges](#).

## 8.2 Currency and amounts

Fees must be paid in euros. Payments in other currencies are not accepted.

The fees for filing an application are as follows.

### Registration fees

Single design or first design in a multiple application	EUR 230
2nd to 10th design in a multiple application	EUR 115 per design
11th+ design in a multiple application	EUR 50 per design

### Publication fees

Single design or first design to be published in a multiple application	EUR 120
2nd to 10th design to be published in a multiple application	EUR 60 per design
11th+ design to be published in a multiple application	EUR 30 per design

### Deferment fees (where deferment of publication is requested)

Single design or first design with deferment of publication in a multiple application	EUR 40
2nd to 10th design with deferment of publication in a multiple application	EUR 20 per design

11th+ design with deferment of publication in a multiple application	EUR 10 per design
--	-------------------

*Example of fees due for the filing of a multiple application where the publication of only some designs is to be deferred*

Design number	Deferment	Registration fee	Publication fee	Deferment fee
xx xxx xxx-0001	Yes	EUR 230	-	EUR 40
xx xxx xxx-0002	Yes	EUR 115	-	EUR 20
xx xxx xxx-0003	No	EUR 115	EUR 120	-
xx xxx xxx-0004	No	EUR 115	EUR 60	-
xx xxx xxx-0005	No	EUR 115	EUR 60	-

If, after registration, publication is requested for design xxxxxxxx-0001, this will in effect be the fourth design to be published and the publication fee will be EUR 60.

### 8.3 Means of payment, details of the payment and refunds

The means of payment, the details to accompany the payment and the conditions for a refund of fees paid are explained in the Guidelines, [Part A, General Rules, Section 3, Payment of Fees, Costs and Charges](#).

Fees are refunded when the application is withdrawn or refused without a filing date having been granted (application 'not dealt with as a Community design application').

The Office also refunds amounts paid that are insufficient to cover the registration and publication (or deferment) fees for the design or at least one design of a multiple application.

## 9 Withdrawals and Corrections

### 9.1 Introduction

The applicant may at any time during the examination withdraw an application for a registered Community design or, in the case of a multiple application, withdraw some of the designs contained in the multiple application. Corrections are allowed only in some specific situations.

Any correction or change to the Register and/or publication, that is after the design has been registered by the examiner, must be dealt with in accordance with [paragraph 11](#) below.

## 9.2 Withdrawal of the application

Prior to registration the applicant may at any time withdraw an application for a Community design or, in the case of a multiple application, withdraw some of the designs contained in the multiple application (Article 12(1) CDIR). The examiner will send confirmation of the withdrawal.

The 'date of withdrawal' is the date on which the Office receives the request for withdrawal.

Requests for withdrawal must be submitted in writing and include:

- the file number of the application for a registered Community design or, where the request for withdrawal is submitted before an application number has been allocated, any information enabling the application to be identified, such as the reference number of the applicant/representative and/or the provisional file number referred to in the automatic receipt for applications filed via the e-filing system;
- in the case of a multiple application, an indication of which design(s) the applicant wants to withdraw if not all are to be withdrawn; and
- the name and address of the applicant and/or, if applicable, the name and address of the representative.

**Fees will only be refunded if no filing date has been granted**, except where the amount of fees paid by the applicant is insufficient to cover the fees relating to registration and publication (or deferment as the case may be) for the design, or for at least one design of a multiple application.

Requests for withdrawal received by the Office on or after the date of registration of the design will be dealt with as requests for surrender (see [paragraph 11.2.2](#) below).

Requests for withdrawal received by the Office on the filing date of the design application will be accepted even if the design is registered that same day.

## 9.3 Corrections to the application

### 9.3.1 Elements subject to correction

Only the name and address of the applicant or the representative, errors of wording or of copying, or obvious mistakes may be corrected, at the request of the applicant (Article 12(2) CDIR). Corrections in the name and address are not to be confused with a change of name, or a transfer (see the Guidelines, Part A, General rules, Section 5, Parties to the proceedings and professional representation, paragraphs [10](#) and [11](#),

and [Part E, Register operations, Section 3, EUTMs and RCDs as objects of property, Chapter 1, Transfer](#)).

Apart from the name and address of the applicant or representative, the following elements may be corrected at the applicant's request if they contain errors of wording or of copying or obvious mistakes:

- the date of filing, where the application was filed with the central industrial property office of a Member State or, in Benelux countries, with the BOIP, upon notification by the office concerned that an error regarding the date of receipt has been made;
- the name of the designer or team of designers;
- the second language;
- an indication of the product(s);
- the classification of the product(s) contained in the application;
- the country, date and number of the prior application where Convention priority is claimed;
- the name, place and date of the first exhibition of the design, where exhibition priority is claimed;
- the description.

### **9.3.2 Elements that cannot be corrected**

As a matter of principle, the representation of the design(s) cannot be altered after the application has been filed (Article 12(2) CDIR). This also applies even if the altered representation is submitted on the same date. The submission of additional views or the withdrawal of any views at a later stage will not be accepted, unless expressly required or proposed by the Office (see paragraphs [5.3](#) and [5.6](#) above).

Where a request for correction amends the representation of the design(s), the applicant will be informed that its request is not acceptable. The applicant must decide whether it wishes to continue the registration process or to file a fresh application for which it will have to pay the applicable fees.

### **9.3.3 Procedure for requesting correction**

A request for correction of the application must contain:

1. the file number of the application;
2. the name and address of the applicant;
3. where the applicant has appointed a representative, the name and business address of the representative;
4. an indication of the element of the application to be corrected and the corrected version of that element.

A single request may be made for correction of the same element in two or more applications belonging to the same applicant.

If all the requirements are met, the examiner will send confirmation of the correction.

For corrections and amendments see [paragraph 11](#) below.

### 9.3.4 Deficiencies

Where a request for correction does not meet the above requirements and the deficiency found can be remedied, the examiner will invite the applicant to remedy the deficiency within 2 months. If the deficiency is not remedied in due time, the examiner will refuse the request for correction.

Requests for correction that would have the effect of amending the representation of the design(s) will be refused irremediably.

Descriptions submitted after the date of filing of the application are not accepted (see [paragraph 6.2.2](#) above). Requests for correction that involve submitting a description for the first time after the date of filing of the application will therefore be refused.

## 10 Registration, Publication and Certificates

### 10.1 Registration

Once the examination of grounds for non-registrability and formalities is completed, the examiner must ensure that all the particulars referred to in Article 14 CDR have been provided (particulars that are mandatory for the applicant and that must be indicated in the application are in bold type):

1. the filing date of the application;
2. the file number of the application and of each individual design included in a multiple application;
3. the date of publication of the registration;
4. **the name, address and nationality of the applicant and the state in which it is domiciled or has its seat or establishment;**
5. **the name and business address of the representative**, other than an employee acting as representative in accordance with the first sentence of Article 77(3) CDR; where there is more than one representative, only the name and business address of the first-named representative, followed by the words 'et al.', will be recorded; where an association of representatives is appointed, only the name and business address of the association will be recorded;
6. **the representation of the design;**
7. **an indication of the product(s)** by name, preceded by the number(s) of and grouped according to the class(es) and subclass(es) of the Locarno Classification;
8. particulars of priority claims pursuant to Article 42 CDR;
9. particulars of exhibition priority claims pursuant to Article 44 CDR;
10. the citation of the designer or team of designers or a statement that the designer or team of designers has waived the right to be cited;

11. **the language in which the application was filed and the second language** indicated by the applicant pursuant to Article 98(2) CDR;
12. the date of registration of the design in the Register and the registration number;
13. a mention of any request for deferment of publication pursuant to Article 50(3) CDR, specifying the date of expiry of the period of deferment;
14. a mention that a specimen has been filed pursuant to Article 5 CDIR;
15. a mention that a description was filed pursuant to Article 1(2)(a) CDIR;
16. a mention that the representation of the design contains a verbal element.

Once all the particulars in the checklist are on file, the examiner will check whether all the applicable fees have been paid.

Where no deficiency is found, the application will be registered.

For further information on entries in the Register, see Decision No EX-21-4 [Annex II](#).

## 10.2 Publication

All registered Community designs are published in the *Community Designs Bulletin*, which is published in electronic format only, on the Office's website.

However, international registrations designating the European Union are published by WIPO (*Hague Express Bulletin*) (see [paragraph 12](#) below).

Unless an application contains a request for deferment of publication, publication will take place immediately after registration; publication is daily.

Where an application contains a request for deferment of publication, publication is made in Part A.2 of the *Community Designs Bulletin* and is limited to the following particulars: the design number, filing date, registration date and the names of the applicant and the representative, if any.

Where an application contains a request for deferment of publication for only some of the designs of a multiple application, only the designs for which deferment has not been requested are published in full.

## 10.3 Registration certificate

A registration certificate is issued after the registered Community design has been published in full (i.e. publication in Part A.1).

However, the Office does not issue registration certificates for international registrations designating the European Union (see [paragraph 12](#) below).

Since 15/11/2010, registration certificates have been issued only as online e-certificates. Holders of Community design registrations are invited to download the certificate from the day after publication, using the 'eSearch plus' tool on the Office's website. No paper copy of the certificate of registration will be issued. However, certified or uncertified copies of the registration certificate may be requested.



The certificate contains all the particulars entered in the Community Designs Register at the date of registration. No new certificate is issued following changes made in the Register after the date of registration. However, an extract from the Register, which reflects the current administrative status of the design(s), may be requested. For more information on obtaining certified extracts from the register, see the Guidelines, [Part E, Register Operations, Section 5, Inspection of Files](#).

A corrected certificate is issued after publication of a relative error detected in a design registration (Part A.3.2) or after publication of a relative error detected in a recordal (Part B.1.2). A relative error is an error attributable to the Office that modifies the scope of the registration.

## **11 Corrections and Changes in the Register and in the Publication of Community Design Registrations**

### **11.1 Corrections**

#### **11.1.1 General principles**

Only the name and address of the applicant, errors of wording or of copying, or obvious mistakes may be corrected, at the request of the applicant and provided that such correction does not change the representation of the design (Article 12(2) CDIR) (03/12/2013, [R 1332/2013-3](#), Adapters, § 14 et seq.). There is no fee for such requests.

Where the registration of a design or the publication of the registration contains a mistake or error attributable to the Office, the Office will correct the error or mistake of its own motion or at the request of the holder (Article 20 CDIR). There is no fee for such requests.

A request for correction of mistakes made by the Office can only refer to the contents of the publication of the registration (Articles 49, 73 and 99 CDR and Articles 14 and 70 CDIR) and the entries in the Register (Articles 48, 72 and 99 CDR and Articles 13 and 69 CDIR).

Unless the Office itself made an error when publishing the representation of the design(s) (e.g. by distorting or truncating the representation), the holder will not be allowed to request the correction of its Community design if this has the effect of altering the representation (Article 12(2) CDIR) (03/12/2013, [R 1332/2013-3](#), Adapters, § 14 et seq.).

Corrections will be made as soon as the mistake is detected, including, where necessary, years after the original entry in the Register.

### 11.1.2 The request for correction

According to Articles 12 and 19 CDIR, requests for the correction of mistakes and errors in the Register and in the publication of the registration must contain:

1. the registration number of the registered Community design;
2. the name and address of the holder as registered in the Register or the name of the holder and the identification number assigned to the holder by the Office;
3. where the holder has appointed a representative, the name and business address of the representative or the name of the representative and the identification number assigned to the representative by the Office; and
4. an indication of the entry in the Register and/or of the content of the publication of the registration to be corrected and the corrected version of the element in question.

A single request may be made for the correction of errors and mistakes in respect of two or more registrations belonging to the same holder (Article 19(4) CDIR and Article 20 CDIR).

If the requirements for such corrections are not fulfilled, the Office will inform the applicant of the deficiency. If the deficiency is not remedied within the 2 months specified by the Office, the request for correction will be refused (Article 19(5) CDIR and Article 20 CDIR).

Requests for the correction of mistakes or errors that are not entries in the Register and/or that do not concern the contents of the publication of registrations will be refused. Accordingly, requests for correction of the description explaining the representation of the design or the specimen will be refused.

Errors in the translation of the product indication into the official EU languages are considered attributable to the Office and will be corrected because the translations are considered as entries in the Register and as part of the contents of the publication of the registration, despite the fact that the translations are done not by the Office but by the Translation Centre for the Bodies of the European Union (Communication No [4/05](#) of the President of the Office concerning the correction of mistakes and errors in the Register and in the publication of the registration of Community designs).

In cases of doubt, the text in the Office language in which the application for a registered Community design was filed will be authentic (Article 99(3) CDR). If the application was filed in an official EU language other than one of the Office languages, the text in the second language indicated by the applicant will be authentic.

### 11.1.3 Publication of corrections

The holder will be notified of any changes in the Register (Article 69(5) CDIR).

Corrections will be published by the Office in Part A.3 of the *Community Designs Bulletin* and entered in the Register together with the date on which they were recorded (Article 20 CDIR and Article 69(3)(e) CDIR).

Where the mistake or error is attributable to the Office, the Office will, after publication of the mistake or error, issue the holder with a certificate of registration containing the entries in the Register (Article 69(2) CDIR) and a statement to the effect that those entries have been recorded in the Register (Article 17 CDIR).

In cases where the mistake or error is the holder's, a certificate of registration reflecting the corrected mistake or error will be issued only where no certificate has previously been issued. In any event, holders can always request the Office to issue an extract of the Register (in certified or simple form) to reflect the current status of their design(s). For more information on obtaining certified extracts from the register, see the Guidelines, [Part E, Register Operations, Section 5, Inspection of Files](#).

## 11.2 Changes in the Register

### 11.2.1 Introduction

This paragraph describes the changes in the Community Designs Register, as follows:

- surrender of a Community design with or without deferment, in particular partial surrender;
- changes in the name and/or address of the applicant/holder and/or of the representative, before registration of the Community design (i.e. before issue of the notification of registration);
- changes in the name and address of the holder and/or of the representative, where applicable, for a Community design with deferred publication that has not been published yet;
- recordal of transfers;
- recordal of licences.

### 11.2.2 Surrender of the registered Community design

#### 11.2.2.1 General principles

A Community design may be surrendered by the holder at any time after registration. A surrender must be declared to the Office in writing (Article 51 CDR).

However, a request for renunciation of an international design designating the European Union must be filed with, and recorded by, the International Bureau (see Article 16 Geneva Act and [paragraph 12.2.2.5](#) below) <sup>(5)</sup>.

Surrender can also be declared for only some of the designs contained in a multiple registration (Article 27(1)(d) CDIR).

---

<sup>5</sup> The Hague Agreement Concerning the International Registration of Industrial Designs, Geneva Act of 02/07/1999.

The effect of a declaration of surrender begins on the date on which the surrender is entered in the Community Designs Register, without any retroactive effect (Article 51(1) CDR). However, if a Community design for which publication has been deferred is surrendered, it will be deemed from the outset not to have had the effects specified in the CDR (Article 51(2) CDR).

A registered Community design may be partially surrendered provided that its amended form complies with the requirements for protection, and the identity of the design is retained (Article 51(3) CDR). Partial surrender will therefore be limited to cases in which the features removed or disclaimed do not contribute to the novelty or individual character of a Community design, in particular:

- where the Community design is incorporated in a product that constitutes a component part of a complex product, and the features removed or disclaimed are invisible during normal use of this complex product (Article 4(2) CDR); or
- where the features removed or disclaimed are dictated by a function or for the purposes of interconnection (Article 8(1) and (2) CDR); or
- where the features removed or disclaimed are so insignificant in view of their size or importance that they are likely to go unnoticed.

The surrender will be entered in the Register only with the agreement of the proprietor of a right entered in the Register (Article 51(4) CDR). Persons having a registered right include the holders of a registered licence, the proprietors of a registered right *in rem*, the creditors of a registered levy of execution or the authority competent for a registered bankruptcy or similar procedures.

In the case of licences registered in the Community Designs Register, the surrender of a Community design is entered in the Register only upon receipt of evidence that the rights holder has informed licensee(s) of the surrender accordingly. The surrender is entered in the Register 3 months after the date on which the Office obtains proof that the holder has informed licensee(s) of the surrender accordingly, or earlier if proof is obtained of the licensee's(licensees') consent to the surrender (Article 51(4) CDR; Article 27(2) CDIR).

Where a claim relating to the entitlement to a registered Community design has been brought before a court pursuant to Article 15 CDR, the surrender is entered in the Register only with the agreement of the claimant (Article 27(3) CDIR).

#### 11.2.2.2 Formal requirements for a declaration of surrender

The proprietor must declare the surrender to the Office in writing. The general rules for communication with the Office apply (see the Guidelines, [Part A, General Rules, Section 1, Means of Communication, Time Limits](#)).

The declaration of surrender may be filed in the language used for filing the application or in the second language.

However, when the declaration of surrender is filed using the form provided by the Office pursuant to Article 68 CDIR, according to Article 80(c) CDIR, the form may be used in any of the official languages of the European Union, provided that the form is

completed in one of the languages of the Office, as far as textual elements are concerned.

A declaration of surrender must contain the particulars referred to in Article 27(1) CDIR:

1. the registration number of the registered Community design;
2. the name and address of the holder;
3. the name and business address of the representative, where appointed;
4. an indication of the designs for which the surrender is declared in the case of multiple registrations;
5. a representation of the amended design in accordance with Article 4 CDIR in the case of partial surrender.

If a declaration of surrender does not contain all the particulars listed above and does not fulfil all the above requirements the Office will notify the holder of the deficiencies and request that they be remedied within the prescribed time limit. Where the deficiencies are not remedied within the time limit, the surrender will not be entered in the Register and the Community design holder will be informed thereof in writing (Article 27(4) CDIR).

### **11.2.3 Changes in the name and/or address of the applicant/holder and/or its representative or in the citation of the designer or team of designers**

The RCD holder may request a recordal of the change of name or address in the Register by submitting a written request to the Office. Recordals of changes of name and/or address are free of charge.

The request for a recordal of a change of name or address in respect of an international design designating the European Union must be filed with the International Bureau (see Article 16 Geneva Act).

For the differences between a change of name and a transfer, see the Guidelines for Examination, [Part A, General rules, Section 5, Parties to the proceedings and professional representation, paragraph 10, Change of name and address](#) and [Part E, Register operations, Section 3, EUTMs and RCDs as objects of property, Chapter 1, Transfer](#).

A single request may be made for a change of name or address for two or more registrations belonging to the same holder.

A request for a change of name or address by an RCD holder must contain:

1. the registration number of the RCD;
2. the holder's name and address as recorded in the Register or the holder's identification number;
3. an indication of the new name and address;
4. the name and business address of the representative, where appointed.

Where the change concerns the citation or the removal of the designer or team of designers, the request must also contain:

- an indication of the designer or team of designers to be added; or
- a statement, signed by the designer or team of designers being removed, that they waive their right to be cited.

If the above requirements are not fulfilled, the Office will send a deficiency letter. If the deficiency is not remedied within the specified time limit, the Office will refuse the request (Article 19(5) CDIR).

Changes of name and address for applications for RCDs are not entered in the Register but must be recorded in the files kept by the Office concerning RCD applications (Article 19(7) CDIR).

Changes in the holders of RCD registrations are published in Part B.2.2 of the *Community Designs Bulletin*, while transfers of rights are published in Part B.2.1. Changes in the representatives are published in Part B.9 of the *Community Designs Bulletin*. Changes in the citation of the designer or team of designers are published in Part B.10.2 of the *Community Designs Bulletin*.

## 11.2.4 Transfers

A Community design registration may be transferred by the holder, and transfers are recorded upon request in the Register. However, the request for recording a transfer in respect of an international design designating the European Union must be filed with the International Bureau (see Article 16 Geneva Act).

The legal provisions contained in the CDR, CDIR and CDFR in respect of transfers correspond to the provisions in the EUTMR and EUTMIR respectively (see the Guidelines for Examination, [Part E, Register Operations, Section 3, EUTMs and RCDs as Objects of Property, Chapter 1, Transfer](#)).

The legal principles and procedure for the recordal of trade mark transfers apply *mutatis mutandis* to Community designs with the following particularities.

## 11.2.5 Licences

### 11.2.5.1 General principles

Community design registrations may be licensed by the holder and the licences recorded upon request in the Register. The provisions of the CDR and CDIR dealing with Community design licences (Articles 27, 32 and 33, and Article 51(4) CDR; Articles 24 and 25, and Article 27(2) CDIR) are almost identical to those in the EUTMR and EUTMIR (see the Guidelines for Examination, [Part E, Register Operations, Section 3, EUTMs and RCDs as Objects of Property, Chapter 2, Licences, Rights in Rem, Levies of Execution, Insolvency Proceedings or Similar Proceedings](#)).

The legal principles and procedure for the recordal of licences in respect of European Union trade marks apply *mutatis mutandis* to Community designs (Article 24(1) CDIR) with the following particularities.

#### 11.2.5.2 Registered Community designs

There is no use requirement in Community design law. Therefore, the issue of whether use by a licensee is use with the consent of the rights holder does not arise.

The CDR and CDIR require an indication of the products in which the design is intended to be incorporated or to which it is intended to be applied (see [paragraph 6.1.4](#) above). The recordal of a partial licence for only some of the products in which the design is intended to be incorporated or applied to is not possible.

Any limitations of the scope of the licence will therefore be disregarded by the Office, and the licence will be registered as if there were no such limitations.

#### 11.2.5.3 Multiple applications for registered Community designs

An application for a registered Community design may take the form of a multiple application combining several designs (Article 37 CDR).

Each design contained in a multiple application may be licensed independently of the others (Article 24(1) CDIR).

#### 11.2.5.4 Fees

The fee of EUR 200 for the recordal, transfer or cancellation of a licence applies per design, not per application, with a ceiling of EUR 1 000 if multiple requests are submitted in the same application (points 18 and 19 of the Annex to the CDFR).

##### Example 1

From a multiple application for 10 designs, 6 designs are licensed to the same licensee. The fee for registering the licences is EUR 1 000, provided that

- all six licences are included in a single registration request, or
- all the relevant requests are submitted on the same day.

The request may indicate that, for three of these six designs, the licence is an exclusive one, without this having any impact on the fees to be paid.

##### Example 2

From a multiple application for 10 designs, 5 designs are licensed to the same licensee. A licence is also granted for another design not contained in that multiple application. The fee is EUR 1 000, provided that:

- all six licences are included in a single registration request, or that all the relevant requests are submitted on the same day, and
- the holder of the Community design and the licensee are the same in all six cases.



## 11.2.6 Entitlement proceedings

Registered Community designs may be the subject of entitlement proceedings and subsequent changes in ownership (see the Guidelines, [Part E, Register Operations, Section 3, EUTMs and RCDs as Objects of Property, Chapter 2, Licences, rights in rem, levies of execution, insolvency proceedings, entitlement proceedings or similar proceedings](#)).

# 12 International Registrations

This part of the Guidelines deals with the particularities of examining international registrations designating the European Union that result from applications filed with the International Bureau of the World Intellectual Property Organization (hereinafter referred to as 'international registrations designating the EU' and 'the International Bureau') under the Geneva Act of 02/07/1999 of the Hague Agreement Concerning the International Registration of Industrial Designs.

The following general overview merely serves to set the framework for the Office's role in the examination of international registrations designating the EU. It is therefore limited in scope and the rules and practices issued by WIPO in relation to international registrations prevail. A full review of the Hague System and how to apply under it can be found directly at <https://www.wipo.int/hague/en/>.

## 12.1 General overview of the Hague System

### 12.1.1 The Hague Agreement and the Geneva Act

The Hague Agreement is an international registration system that makes it possible to obtain protection for designs in a number of states and/or intergovernmental organisations, such as the European Union or the African Intellectual Property Organization, by means of a **single** international application filed with the International Bureau. Under the Hague Agreement, a single international application replaces a whole series of applications that, otherwise, would have had to be filed with different national intellectual property offices or intergovernmental organisations.

The Hague Agreement consists of two separate international treaties: the Hague Act (1960) and the Geneva Act (1999). Each Act has a different set of legal provisions, which are independent of one another.

International registrations designating the European Union are governed by the Geneva Act.



## 12.1.2 Procedure for filing international applications

### 12.1.2.1 Particularities

Unlike the Protocol Relating to the Madrid Agreement Concerning the International Registration of Marks, the Geneva Act neither allows nor requires an international registration to be based on a previously filed Community or national design.

This means that the Office can only be a 'designated office', not an 'office of origin'. **International applications must therefore be filed directly with the International Bureau** (Article 106b CDR).

Furthermore, neither the Geneva Act nor the CDR provides procedures for transforming an international registration designating the EU into a Community or national design application(s) or for converting an international registration designating the EU into national design applications(s) of EU Member States and into designations of contracting parties to the Hague System, or for replacing Community or national design registrations by an international registration designating the contracting party in question. Nor does the Geneva Act provide for the possibility of Subsequent Designation of the EU.

The Geneva Act and the Common Regulations under the 1999 Act and the 1960 Act of the Hague Agreement (CR) contain specific rules, which may differ from those applicable to 'direct filings' of Community designs, that is, applications filed directly with the Office or via the central industrial property office of a Member State or, in Benelux countries, the BOIP (see [paragraph 2.2.1](#) above). These specific rules relate, in particular, to i) entitlement to file an international application, ii) the contents of an international application, iii) fees and iv) publication and deferment of publication.

### 12.1.2.2 Entitlement to file an international application

To be entitled to file an application for international registration under the Geneva Act, an applicant must satisfy at least one of the following conditions:

1. be a national of a Contracting Party or a Member State of an intergovernmental organisation that is a Contracting Party, such as the European Union or the African Intellectual Property Organization, *or*
2. have a domicile or a habitual residence in the territory of a Contracting Party, *or*
3. have a real and effective industrial or commercial establishment in the territory of a Contracting Party.

### 12.1.2.3 Contents of an international registration designating the EU

The applicant can choose to file the international application in **English, French or Spanish** (Rule 6(1) CR) and electronically through the electronic filing (e-filing) interface available on the WIPO website ([www.wipo.int/hague/en/e-filing.html](http://www.wipo.int/hague/en/e-filing.html)) or using the official form available on the WIPO website ([www.wipo.int/hague/en/forms/](http://www.wipo.int/hague/en/forms/)).

No prior national or regional application or registration is required.

An international application may include **up to 100 different designs**. All designs must, however, belong to the same class of the International Classification for Industrial Designs (the Locarno Classification).

It must, in particular, contain a reproduction of the industrial designs concerned, together with the designation of the contracting parties where protection is sought.

#### 12.1.2.4 Fees for international registrations designating the EU

Three types of fees must be paid for an international application designating the European Union, namely: <sup>(6)</sup>

- a basic fee;
- a publication fee;
- an individual designation fee, that is, EUR 62 per design, converted into Swiss francs (Article 106c CDR; Article 1a to the Annex of the CDFR; Rule 28 CR).

#### 12.1.2.5 Publication and deferment of publication of international registrations designating the EU

As a general rule, publication in the *International Designs Bulletin* takes place 6 months after the international registration date.

An international application designating the EU may contain a request that the international registration be published immediately.

Where immediate publication is requested, publication will take place as soon as the necessary technical preparations have been carried out after the registration of the industrial design.

An international application may contain a request that publication of the design, or of **all** the designs contained in a multiple application, be deferred. The Geneva Act does not allow deferment of publication to be requested for only some of the designs contained in a multiple application (Article 11 Geneva Act).

The period of deferment of publication for an international application designating the European Union is 30 months from the filing date or, where priority is claimed, the priority date. The application will be published at the end of this 30-month period unless the holder submits a request for earlier publication to the International Bureau (Article 11 Geneva Act).

The procedure described in [paragraph 6.2.5](#) above does **not** apply as the Office is not responsible for publishing international registrations designating the European Union.

---

<sup>6</sup> See [www.wipo.int/hague/en/fees](http://www.wipo.int/hague/en/fees). See [www.wipo.int/hague/en/fees](http://www.wipo.int/hague/en/fees)

## 12.2 The role of the International Bureau

When it receives an international application, the International Bureau checks that it complies with the prescribed **formal** requirements, such as those described under paragraphs [12.1.2.2](#) and [12.1.2.3](#) above, as well as those relating to the quality of the reproductions of the design(s), priority claims and the payment of the required fees. The applicant is informed of any deficiency, which must be corrected within the prescribed time limit of 3 months, failing which the international application is considered to be abandoned. All communications must be sent to the International Bureau.

Where an international application complies with the prescribed formal requirements, the International Bureau records it in the International Register and (unless deferment of publication has been requested (see [paragraph 12.1.2.5](#) above)) publishes the corresponding registration in the *International Designs Bulletin*. Publication takes place electronically on the **WIPO** website and contains all relevant data concerning the international registration, including a reproduction of the design(s).

The International Bureau does not examine the novelty or individual character of the design and it is therefore not entitled to reject an international application on this, or any other, substantive ground.

The International Bureau notifies the international registration to all designated offices, which then have the option of refusing protection on substantive grounds.

The following changes, which may affect an international registration, may be recorded in the International Register:

1. change in name and address of the holder;
2. change in the ownership of the international registration (in respect of all or some of the designated contracting parties and/or in respect of all or some of the industrial designs);
3. renunciation of all the industrial designs, in respect of any or all of the designated contracting parties; and
4. limitation of some only of the industrial designs, in respect of any or all of the designated contracting parties.

A request for the recording of such changes **must be presented to the International Bureau** on the relevant official form and must be accompanied by the prescribed fees. Information concerning such changes is recorded in the International Register and is published in the Bulletin for the information of third parties.

## 12.3 The role of the Office as designated office

### 12.3.1 General overview

This section explains how international registrations designating the EU are dealt with by the Office from notification by the International Bureau through to the final decision to accept or refuse the designation of the European Union.

One of the main features of the Hague System lies in the possibility for the Office to refuse protection, in the territory of the EU, to an international registration designating the EU that does not fulfil the substantive conditions of protection provided for by its domestic legislation.

Such refusal, however, may not be issued on the grounds of non-compliance with formal requirements, since such requirements are to be considered as already having been satisfied following the examination carried out by the International Bureau.

Any refusal of protection by the Office must be notified to the International Bureau within 6 months from the publication of the international registration designating the EU on the WIPO website. Any refusal of protection will have effect for the entire territory of the EU.

In the event of a refusal, the applicant has the same remedies as he or she would have had if he or she had filed the application in question directly with the Office. The ensuing procedure takes place solely before the Office; an appeal against a refusal must be submitted by the holder to the Boards of Appeal, within the time limit and in accordance with the conditions set out in the CDR and CDIR. The International Bureau is not involved in this procedure.

A refusal may be withdrawn, totally or partially. Such a withdrawal may also take the form of a statement to the effect that protection is granted to the industrial designs, or some of the industrial designs, that are the subject of the international registration designating the EU.

The main roles of the Office as designated office are:

- receipt of the information on the international registration designating the EU;
- examination of the grounds for non-registrability;
- examination of design invalidity applications against international registrations designating the EU.

It is important to note that priority may be claimed at the time of the international application only. The examination of the formal requirements of the priority claim for international applications is carried out by the International Bureau. The EUIPO does not examine priority or request supporting documents for international registrations designating the EU. Any document received by the Office will be archived with no effect on the grant of protection but may be relied upon in *inter partes* proceedings.

### 12.3.2 Receipt of the information on the international registration designating the EU

Communications between the Office and the International Bureau are by electronic means (Article 47(3) CDIR).

### 12.3.3 Grounds for non-registrability

Once the international registration designating the EU has been notified to the Office by the International Bureau, the rules laid down under Title XIa CDR and Article 11a CDIR (Examination of grounds for refusal) apply (Article 106a(1) CDR).

#### 12.3.3.1 Compliance with the definition of a design, public policy and morality

An international registration designating the EU may not be refused on the grounds of non-compliance with **formal** requirements, since such requirements are to be considered as already satisfied following examination by the International Bureau.

The Office limits its examination to the two grounds for non-registrability (Article 11a CDIR). An international registration designating the EU will be refused if a design does not correspond to the definition in Article 3(a) CDR or if it is contrary to public policy or accepted principles of morality (Article 9 CDR) (see [paragraph 4](#) above).

The examination of grounds for non-registrability for international registrations designating the EU will be carried out as if the design(s) had been applied for directly with the Office. The time limits and other general procedural aspects governing the said examination are the same as those that apply in the case of design applications filed directly with the Office (see paragraphs [1.2.3](#) and [4.3](#) above).

#### 12.3.3.2 Time limits

The Office must inform the International Bureau of any refusal of protection within **6 months** of publication of the international registration on the WIPO website (Article 11a(1) CDIR).

A provisional refusal must be reasoned and state the grounds on which refusal is based, and the holder of the international registration designating the EU must be given an opportunity to be heard (Article 106e(1) and (2) CDR).

Thus, within 2 months of the date of the notification of provisional refusal to WIPO, the international registration holder will be given the opportunity to renounce the international registration for the EU (for all the designs in the registration), to limit the international registration to one or some of the designs for the European Union or to submit observations (Article 11a(2) CDIR).

The International Bureau will forward the notification of provisional refusal to the holder (or to its representative before WIPO if applicable). The holder must reply directly to the Office or, if applicable, through its representative (see [paragraph 12.3.3.4](#) below).

For time-limit extensions, see [paragraph 1.2.3](#) above.

### 12.3.3.3 Languages

An international application must be filed in English, French or Spanish (Rule 6(1) CR). The recording and publication of the international registration will indicate the language in which the international application was received by the International Bureau (Rule 6(2) CR). In practice, this language can be identified from the product indication (INID code 54): the first language used in the product indication is the language in which the international application was received by the International Bureau. The indications given in the other two languages are translations provided by the International Bureau (Rule 6(2) CR).

The language in which the international application was received by the International Bureau will be the first language of the EU designation and will therefore become the language of the examination proceedings (Article 98(1) and (3) CDR).

In all communications with the International Bureau, the Office will therefore use the language in which the international registration was filed.

If the holder wishes to communicate with the Office in a different Office language, it must supply a translation into the language in which the international registration was filed within 1 month of the date of submission of the original document (Article 98(3) CDR; Article 81(1) CDIR). If no translation is received within this time limit, the original document is deemed not to have been received by the Office.

### 12.3.3.4 Professional representation

In principle, the holder does not need to appoint a representative before the Office. Holders outside the EEA are, however, required to be represented further to a provisional refusal (see the Guidelines, [Part A, General rules, Section 5, Parties to the proceedings and professional representation](#), and Articles 77 and 78 CDR).

If a non-EEA holder has appointed a representative before WIPO who also appears in the database of representatives maintained by the Office, this representative will automatically be considered to be the holder's representative before the Office.

If representation is mandatory under Article 77(2) CDR (see [paragraph 2.5](#)), where a non-EEA holder has not appointed a representative or has appointed a representative before WIPO who does not appear in the database of representatives maintained by the Office, any notifications of provisional refusal or objection will contain an invitation to appoint a representative in compliance with Articles 77 and 78 CDR.

Where the holder has a WIPO representative **within** the EU who does not appear in the database of representatives maintained by the Office, the Office will inform this representative that if they wish to represent the holder before the Office, they must

specify the basis of their entitlement (i.e. whether they are a legal practitioner or professional representative within the meaning of Article 78(1)(a) or (b) or Article 78(4) CDR or an employee representative within the meaning of Article 77(3) CDR (see the Guidelines, [Part A, General rules, Section 5, Parties to the proceedings and professional representation](#)).

If the holder fails to appoint a representative within the specified time limit, the Office will refuse protection of the international registration (Article 11a(4) CDIR).

#### 12.3.3.5 Renunciation and limitation

Where the holder renounces the entire international registration in the EU or limits it to one or some of the designs for the European Union, it must inform the International Bureau by way of recording procedure in accordance with Article 16(1)(iv) and (v) of the Geneva Act. The holder can inform the Office by submitting a corresponding statement (Article 11a(6) CDIR).

#### 12.3.3.6 Grant of protection

Where the Office finds no grounds for refusing protection or where a provisional refusal is withdrawn, the Office must inform the International Bureau accordingly without delay.

#### 12.3.3.7 Refusal

Where the holder does not renounce the international registration for the EU, does not limit it to one or some of the designs, does not submit observations that satisfy the Office within the specified time limit, or does not withdraw the application, the Office will confirm its decision refusing protection for the international registration. If the refusal concerns only some of the designs contained in a multiple international registration, the Office will refuse the latter only insofar as those designs are concerned (Article 11(3) CDIR).

There is no legal provision in the CDR or CDIR allowing an applicant to request an amendment of the design in order to overcome an objection concerning an international registration. However, an applicant may renounce the designation of the European Union by addressing WIPO directly, which will then notify the Office.

The holder of the international registration has the same remedies available to it as it would have had if it had filed the design(s) in question directly with the Office. The ensuing procedure takes place solely at Office level. An appeal against a decision to refuse protection must be submitted by the holder to the Boards of Appeal within the time limit and in accordance with the conditions set out in Articles 55 to 60 CDR and Articles 34 to 37 CDIR (Article 11a(5) CDIR). The International Bureau is not involved in this procedure at all.

Once the decision to refuse or accept the international registration designating the EU is final, a final notification will be sent to the International Bureau, indicating whether the design(s) has/have been finally refused or accepted.

Where the final refusal relates to only some of the designs contained in a multiple application, the notification to the International Bureau will indicate which designs have been refused and which have been accepted.

## **12.4 Effects of international registrations**

If no refusal is notified by the Office within 6 months of the publication of the international registration on the WIPO website, or if a notice of preliminary refusal is withdrawn, the international registration will, from the date of registration granted by the International Bureau, as referred to in Article 10(2) Geneva Act (Article 106a(2) CDR), have the same effect as if it had been applied for with, and registered by, the Office.

## **12.5 Invalidity applications against international registrations designating the EU**

International registrations designating the EU can be subject to invalidity proceedings under the same conditions and procedural rules as 'direct filings' of Community designs (Article 106f CDR; see [the Guidelines for Examination of Design Invalidity Applications](#)). An application for a declaration of invalidity must be filed with the Office and clearly identify the international registration number including the contested design within a multiple registration. The contested design within a multiple registration can be clearly identified by indicating the views and the view numbers in which the contested design is registered or by adding an extension number of the particular design to the registration number. Since the language of filing of an international registration designating the EU is necessarily an Office language, an application for a declaration of invalidity against such an international registration must be filed in this language (see [paragraph 12.3.3.3](#) above).

The Office will notify the holder or their representative directly of any request for a declaration of invalidity. Where a non-EEA holder has not appointed a representative or has appointed a representative before WIPO who does not appear in the database of representatives maintained by the EUIPO, the Office will communicate with the holder directly and invite them to appoint a representative who can act before the Office. The holder must reply directly to the Office or, if applicable, through a representative who is on the Office's list in accordance with Article 78 CDR (see [paragraph 2.5](#) above).

Where the Office declares the effects of an international registration invalid in the territory of the European Union, it must inform the International Bureau of its decision as soon as the latter becomes final (Article 106f(2) CDR; Article 71(3) CDIR).

## **12.6 Changes affecting international registrations**

The International Register is kept at WIPO.



The procedures governing the renewal of international registrations and records of changes of name, transfers, renunciation or limitation of certain designs, registration for any or all of the designated contracting parties, or limitation of the registration to certain designs are dealt with by the International Bureau (see the Guidelines, [Part E, Register Operations, Section 4, Renewal, paragraph 13](#); Articles 16 and 17 Geneva Act; Article 22a CDR).

The EUIPO will not process requests for renewal or payments of renewal fees.

## **13 Enlargement and the Registered Community Design**

This section discusses the rules relating to the accession of new Member States to the European Union and the consequences thereof for applicants for, and holders of, registered Community designs.

Ten new Member States joined the European Union on 01/05/2004 (the Czech Republic, Estonia, Cyprus, Latvia, Lithuania, Hungary, Malta, Poland, Slovenia and Slovakia), two on 01/01/2007 (Bulgaria and Romania) and one on 01/07/2013 (Croatia), bringing the number of Member States up to 28.

Article 110a CDR contains provisions relating to enlargement as regards registered Community designs. These provisions were inserted in the CDR when the EU was enlarged in 2004 and remain applicable for successive enlargements. The only modification to the text of the CDR is the addition of the names of the new Member States.

As far as registrability and validity of Community designs are concerned, the effects of the enlargement of the European Union on registered Community design rights are the following.

### **13.1 The automatic extension of the Community design to the territories of the new Member States**

Pursuant to Article 110a(1) CDR, the effects of all Community design rights filed before 01/05/2004, 01/01/2007 or 01/07/2013 extend automatically to the territories of the Member States that acceded on those dates (Article 110a(1) CDR).

Extension is automatic in the sense that there are no administrative formalities and no extra fees. Moreover, it cannot be opposed by the Community design holder or any third party.

## **13.2 Other practical consequences**

### **13.2.1 Filing with national offices**

As from the enlargement date, Community design applications may also be filed through the industrial property office of the new Member State.

### **13.2.2 Professional representation**

As from the accession date, applicants (as well as other parties to proceedings before the Office) that have their seat or domicile in a new Member State no longer need to be represented by a professional representative. As from the accession date, professional representatives from a new Member State may be entered on the list of professional representatives maintained by the Office pursuant to Article 78 CDR, and may then represent third parties before the Office.

### **13.2.3 First and second language**

Since 01/01/2004 there have been nine new official EU languages, namely Czech, Estonian, Hungarian, Latvian, Lithuanian, Maltese, Polish, Slovak and Slovenian. A further two languages (Bulgarian and Romanian) were added on 01/01/2007 <sup>(7)</sup> and a further one (Croatian) on 01/07/2013.

These languages may be used as the first language only for Community design applications filed on or after the accession date concerned.

### **13.2.4 Translation**

Community design applications with a filing date prior to the accession date, or existing Community design registrations, will neither be translated into, nor republished in the language of the new Member State(s). Community design applications filed after the accession date will be translated and published in all official EU languages.

## **13.3 Examination of grounds for non-registrability**

The Office limits its examination of the substantive protection requirements to only two grounds for non-registrability (Article 47(1) CDR). An application will be refused if the design does not correspond to the definition given in Article 3(a) CDR or if it is contrary

---

<sup>7</sup> For Irish, see [paragraph 2.4](#).

to public policy or to accepted principles of morality (Article 9 CDR) (see [paragraph 4](#) above).

An application for a registered Community design cannot be refused on the basis of any of the grounds for non-registrability listed in Article 47(1) CDR if these grounds become applicable merely because of the accession of a new Member State (Article 110a(2) CDR).

Whether a Community design is in conformity with Article 3 CDR or complies with public order and accepted principles of morality is normally assessed without reference to any particular national or linguistic context.

However, where a Community design contains a word element that is offensive in a language that, as a result of the accession of a new Member State, becomes an official language of the European Union after the date of filing, the ground for non-registrability provided for under Article 9 CDR does not apply.

## **13.4 Immunity against cancellation actions based on grounds for invalidity that become applicable merely because of the accession of a new Member State**

### **13.4.1 General principles**

Community designs filed or registered before 01/05/2004, 01/01/2007 or 01/07/2013 will not be cancelled on the basis of grounds for invalidity that exist in one of the Member States acceding to the European Union on those dates if the ground for invalidity only became applicable as from the accession date in question (Article 110a(3) CDR). This is an expression of the need to respect acquired rights.

Not all grounds for invalidity set out in Article 25(1) CDR may become ‘applicable merely because of the accession of a new Member State’.

#### **13.4.1.1 Grounds for invalidity that are applicable independently of the enlargement of the EU**

The accession of a new Member State has no effect on the applicability of the following four grounds for invalidity. Article 110a(3) CDR therefore does not offer any protection against their application to Community designs filed before 01/05/2004, 01/01/2007 or 01/07/2013 respectively.

##### Non-visibility and functionality

The non-visibility of a Community design applied to a part of a complex product and the restrictions applying to features of a design that are solely dictated by technical function or the requirements of interconnection are grounds for invalidity that must be evaluated on the basis of the design itself and not of a factual situation that exists in any given Member State (Article 25(1)(b) CDR in conjunction with Articles 4 and 8 CDR).

#### Novelty and individual character

Under normal circumstances, lack of novelty or individual character of a Community design will not be affected by enlargement of the EU (Article 25(1)(b) CDR in conjunction with Articles 5 and 6 CDR).

The disclosure of a design prior to the filing or priority date of a Community design can destroy the latter's novelty or individual character, even if such disclosure took place in a country before the date of its accession to the EU. The sole requirement is that such disclosure could 'reasonably have become known in the normal course of business to the circles specialised in the sector concerned, operating within the Community' (Article 7(1) CDR).

#### Entitlement to the Community design

The fact that the holder is not entitled to the Community design as a result of a court decision is another ground for invalidity that is not affected by enlargement (Article 25(1)(c) CDR). Article 14 CDR does not impose any nationality requirement for the person claiming to be entitled to the Community design, nor does it require that the court decision originates from a court located in a Member State.

#### Improper use of one or more of the elements listed in Article 6ter of the Paris Convention

The invalidity ground of improper use of one or more of the elements listed in Article 6ter of the Paris Convention is not affected by enlargement of the EU either. There is no requirement for the sign of which use is prohibited to come from a Member State (Article 25(1)(g) CDR).

### 13.4.1.2 Grounds for invalidity resulting from enlargement of the EU

A Community design filed before 30/04/2004, 31/12/2006 or 30/06/2013 respectively cannot be invalidated on the basis of any of the five grounds for invalidity referred to below where any of these grounds becomes applicable as a result of the accession of a new Member State on those dates (Article 110a(3) CDR).

#### Conflict with a prior design right protected in a new Member State (Article 25(1)(d) CDR)

A Community design filed before the date of accession of a Member State cannot be invalidated on the basis of a conflict with an earlier design that has enjoyed protection in the new Member State since a date prior to the filing or priority date of the Community design but that was disclosed to the public at a later date.

#### Use of an earlier distinctive sign (Article 25(1)(e) CDR)

A Community design filed before the date of accession of a Member State cannot be invalidated on account of the use of a distinctive sign that has enjoyed protection in the new Member State since a date prior to the filing or priority date of the Community design.

#### Unauthorised use of a work protected under the copyright law of a Member State (Article 25(1)(f) CDR)

A Community design filed before the date of accession of a Member State cannot be invalidated on account of the non-authorised use of a work that has been protected by the copyright law of the new Member State since a date prior to the filing or priority date of the Community design.

Improper use of signs, emblems, coats of arms, other than those covered by Article 6ter of the Paris Convention (Article 25(1)(g) CDR)

A Community design filed before the date of accession of a Member State cannot be invalidated on account of the improper use of signs, emblems or coats of arms, other than those covered by Article 6ter of the Paris Convention, which are of particular public interest for the new Member State.

Public policy and morality

A Community design filed before the date of accession of a new Member State cannot be invalidated on account of being contrary to public policy or morality in the territory of the new Member State.

### **13.4.2 Effects of a priority claim**

Community designs with a filing date on or after 01/05/2004, 01/01/2007 or 01/07/2013 respectively may be invalidated on the basis of the five grounds mentioned above.

This applies even if the priority date of the Community design in question precedes the relevant accession date. The priority right does not protect the Community design holder against any change in the law that is applicable to the validity of its design.

---

***GUIDELINES FOR EXAMINATION OF  
REGISTERED COMMUNITY DESIGNS***

***EUROPEAN UNION  
INTELLECTUAL PROPERTY OFFICE  
(EUIPO)***

***Examination of design invalidity  
applications***



# 1 Purpose

The purpose of these Guidelines is to explain how, in practice, the provisions of the Community Design Regulation <sup>(8)</sup> (CDR), the Community Design Implementing Regulation <sup>(9)</sup> (CDIR), and the Fees Regulation <sup>(10)</sup> (CDFR) are applied by the Office from receipt of an application for a declaration of invalidity of a Community design (application) up to the point of closure of the invalidity proceedings. Their purpose is also to ensure consistency among the decisions taken by the Invalidity Division and to ensure coherent practice in the treatment of the files. These Guidelines are not intended to, and cannot, add to or subtract from the legal contents of the Regulations.

## 2 Introduction - General Principles Applying to Invalidity Proceedings

### 2.1 Duty to state reasons

The decisions of the Invalidity Division must state the reasons on which they are based (Article 62 CDR). The reasoning must be logical and it must not disclose internal inconsistencies.

The Invalidity Division will apply the principles explained in the Guidelines, [Part A, General Rules, Section 2, General Principles to be Respected in the Proceedings, paragraph 1, Adequate Reasoning](#).

### 2.2 Right to be heard

The decisions of the Invalidity Division will 'be based only on reasons or evidence on which the parties concerned have had an opportunity to present their comments' (Article 62 CDR).

---

<sup>8</sup> [Council Regulation \(EC\) No 6/2002 of 12 December 2001 on Community designs](#) amended by Council Regulation No 1891/2006 of 18 December 2006 amending Regulations (EC) No 6/2002 and (EC) No 40/94 to give effect to the accession of the European Community to the Geneva Act of the Hague Agreement concerning the international registration of industrial designs.

<sup>9</sup> [Commission Regulation \(EC\) No 2245/2002 of 21 October 2002 implementing Council Regulation \(EC\) No 6/2001 on Community designs](#) amended by Commission Regulation (EC) No 876/2007 of 24 July 2007 amending Regulation (EC) No 2245/2002 implementing Council Regulation (EC) No 6/2002 on Community designs following the accession of the European Community to the Geneva Act of the Hague Agreement concerning the international registration of industrial designs.

<sup>10</sup> [Commission Regulation \(EC\) No 2246/2002 of 16 December 2002 on the fees payable to the Office for Harmonization in the Internal Market \(Trade Marks and Designs\) in respect of the registrations of Community designs](#) amended by Commission Regulation (EC) No 877/2007 of 24 July 2007 amending Regulation (EC) No 2246/2002 concerning the fees payable to the Office for Harmonization in the Internal Market (Trade Marks and Designs) following the accession of the European Community to the Geneva Act of the Hague Agreement concerning the international registration of industrial designs.



The Invalidation Division will apply the principles explained in the Guidelines, [Part A, General Rules, Section 2, General Principles to be Respected in the Proceedings, paragraph 2, The right to be heard](#).

## 2.3 Scope of the examination carried out by the Office

In invalidation proceedings, the examination carried out by the Office is restricted to the facts, evidence and arguments provided by the parties (Article 63(1) CDR). This does not preclude the Office from taking into consideration well-known facts (16/02/2017, [T-828/14](#) & [T-829/14](#), Radiatori per riscaldamento, EU:T:2017:87, § 90; see the Guidelines, [Part A, General rules, Section 2, General principles to be respected in the proceedings, paragraph 1, Adequate reasoning](#) ).

The Office must weigh the facts, evidence and arguments, adjudicate on their conclusiveness, and thereafter draw legal inferences from them without being bound by the points of agreement between the parties. Alleged facts that are not supported by evidence are not taken into account (12/02/2018, [R 459/2016-G](#), Dishes, § 26).

Facts, evidence and arguments are three different items not to be confused with each other. For instance, the date of disclosure of an earlier design is a fact. Evidence of that fact could be the date of publication of a catalogue showing the earlier design together with evidence proving that the catalogue had been made available to the public before the date of filing or the priority date of the contested RCD. The applicant's argument could be that the earlier design forms an obstacle to the individual character of the contested RCD given that the overall impression the contested design produces on the informed user does not differ from that produced by the earlier design. Whether an RCD lacks individual character or not is not a fact but a legal question to be decided by the Invalidation Division on the basis of the facts, evidence and arguments submitted by the parties.

Expert reports or expert opinions and other statements in writing fall within the means of evidence referred to in Article 65(1)(c) and (f) CDR. However, the fact that they are procedurally admissible does not automatically mean that the statement is credible and will serve as proof of the facts to be proven. Rather, such statements must be critically examined as to the accuracy and correctness of the information, as well as whether they come from an independent source and/or are fettered or supported by written information (09/03/2012, [T-450/08](#), Phials, EU:T:2012:117, § 26).

Moreover, the legal criteria for applying a ground for invalidity are naturally part of the matters of law submitted for examination by the Office. A matter of law may have to be ruled on by the Invalidation Division, even when it has not been raised by the parties, if it is necessary to resolve that matter in order to ensure correct application of the CDR. The Office will thus examine *ex officio* such matters of law that can be assessed independently of any factual background for the purpose of allowing or dismissing the parties' arguments, even if they have not put forward a view on those matters (01/02/2005, [T-57/03](#), Hooligan, EU:T:2005:29, § 21). Such matters of law will include,

inter alia, the definition of the informed user and the degree of freedom of the designer within the meaning of Article 6 CDR.

## 2.4 Compliance with time limits

The Office may disregard facts or evidence that are not submitted in due time by the parties concerned (Article 63(2) CDR).

Parties are reminded that they must submit the facts and evidence on which they rely in due time and within the time limits set by the Office. Parties that fail to observe the time limits run the risk of having their facts and evidence disregarded. Parties have no unconditional right to have facts and evidence submitted after the time limit taken into consideration by the Office.

Where the Office exercises its discretion under Article 63(2) CDR, it must state the reasons why the late facts and evidence are admissible or not, taking into consideration whether the material that has been submitted late is, on the face of it, likely to be relevant to the outcome of the invalidity proceedings brought before it. Furthermore, the Office must consider whether the stage of the proceedings at which the late submission takes place, and the circumstances surrounding it, do not argue against such matters being taken into account (13/03/2007, [C-29/05 P](#), ARCOL / CAPOL, EU:C:2007:162, § 42-44; 05/07/2017, [T-306/16](#), Door handles, EU:T:2017:466, § 15-18).

The discretionary power as to the admissibility of documents submitted outside the time limit only applies to 'supplementary' or 'additional evidence', as opposed to 'entirely new evidence' which is never admissible. 'Entirely new evidence' is characterised by the absence of any link with previously filed evidence and is to be rejected as belated. 'Additional' or 'supplementary evidence' is, on the other hand, evidence that supplements other evidence which was previously submitted in due time. This is the evidence over which the Office can exercise its discretionary power (see by analogy 14/05/2019, [T-89/18 & T-90/18](#), Café del Sol / Café del Sol (fig.) et al., EU:T:2019:331, § 42).

An example of where the Office may exercise its discretion under Article 63(2) CDR to take facts or evidence that were not submitted in due time into consideration could be the evidence submitted by the invalidity applicant in reply to the contested RCD holder's observations, for instance, that disclosure of an earlier design was not properly established pursuant to Article 7 CDR. However, the exercise of this discretionary power requires that the invalidity applicant's evidence supplements the initial evidence for the purpose of rebutting the RCD holder's specific arguments, for instance as to the time or place or circumstances relating to the earlier design's disclosure. Another example is where the evidence was unavailable at an earlier stage or where a fact came to light during the course of the proceedings (14/03/2018, [T-651/16](#), Footwear, EU:T:2018:137, § 34-36; 10/11/2021, [T-443/20](#), Labels, EU:T:2021:767, § 18-22).

Belated evidence concerning a prior design or earlier right which had not been relied upon in the application for a declaration of invalidity is not considered to be additional

and will, therefore, be rejected (Article 28(1)(b)(v) CDIR, see Section 3.10.2, Facts, evidence and arguments) (15/12/2021, [T-682/20](#), Schuwaren, EU:T:2021:907, § 34).

The Office may also exercise its discretion under Article 63(2) CDR with respect to facts and evidence in the holder's response to the invalidity application submitted after the time limit.

If the time limit is still running, the party may request an extension of the time limit, pursuant to Article 57(1) CDIR (see [paragraph 4.1.6](#)).

For general information on time limits, see the Guidelines, [Part A, General rules, Section 1, Means of communication, time limits](#).

## **3 Filing of an Application**

### **3.1 Form of the application**

The Office recommends filing an application by e-filing through the User Area on the Office's website.

For other means of filing an application (Article 52 CDR), the Office provides a form (Article 68(1)(f) CDIR) that can be obtained upon request. Its use is strongly recommended (Article 68(6) CDIR) in order to facilitate the processing of the application and avoid errors. The completed form must be submitted by the applicant to the Office by the statutory means of communication. If an application, including supporting documents, is filed other than by e-filing, it should be submitted in duplicate, in order that one set of documents can be kept in the Office's archive while the other is sent to the holder without any loss of quality due to copying. If an application is submitted in one set only, the Office may invite the applicant to file a second set within a period of 1 month, or 2 months if the applicant does not have its domicile or its principal place of business or an establishment within the European Union (Article 57(1) CDIR).

### **3.2 Scope of the application**

In invalidity proceedings, the relief sought by the applicant can only be the declaration of invalidity of the contested Community design as registered (Article 25 CDR).

Where contested Community designs are part of a multiple registration, each design must be contested individually and identified by reference to its full registration number (Article 37(4) CDR) or the numbering stipulated for multiple international applications respectively. A single application (and a common statement of grounds) may concern more than one Community design of a multiple registration. In such a case, the fee for the application must be paid for each contested Community design. However, for the sake of clarity, the Office recommends that separate applications be filed for each contested Community design.

### **3.3 Language of proceedings**

The language regime in design invalidity proceedings is not the same as that governing trade mark proceedings, as explained below.

The application for a declaration of invalidity must be filed in the language of proceedings, which is the language used for filing the application for registering the contested Community design (language of filing), provided the language of filing is one of the five languages of the Office (Article 98 CDR; Article 29 CDIR).

If the language of filing is not one of the five languages of the Office, the language of proceedings is the second language indicated in the application for the contested Community design (Article 98(4) CDR; Article 29(1) CDIR).

As regards international registrations designating the European Union, the language of proceedings is the language in which the international application was filed (English, French or Spanish). The first language used in the product indication (INID code 54 of the internationally agreed numbers for the identification of (bibliographic) data) is the language in which the international application was filed at the International Bureau. In case of doubt, applicants for a declaration of invalidity are advised to check the language of filing of the international registration with the International Bureau.

Where the application for a declaration of invalidity is not filed in the language of proceedings, the Office will request that the applicant submit a translation within a period of 2 months of the date of receipt of the notification. Where the applicant does not comply with the request, the application will be rejected as inadmissible (Article 30(1) CDIR).

The parties to the invalidity proceedings may agree on a different language of proceedings provided it is an official language of the European Union. Information on the agreement must reach the Office within a period of 2 months of receipt by the holder of the official communication sent after the completion of the admissibility examination, pursuant to Article 31(1) CDIR (see [paragraph 3.14](#) below). Where the application for a declaration of invalidity was not filed in that language, the applicant must, on its own motion, submit a translation of the application in that language within 1 month of the date on which the Office was informed of the agreement (Article 98(5) CDR; Article 29(6) CDIR). If these legal requirements are not met, the language of proceedings will remain unchanged.

For the linguistic regime applicable to the supporting documents, see [paragraph 3.10.2](#) below.

### **3.4 Identification of the applicant**

The application must contain an indication of the name and address of the applicant (Article 28(1)(c)(i) CDIR). For further information, see the Guidelines, Part A, General rules, Section 5, Parties to the proceedings and professional representation,

[paragraph 2, Parties to proceedings before the Office](#) and [paragraph 3, Identification of parties to the proceedings](#).

Where the information given in the application does not make it possible to identify the applicant unambiguously, and the deficiency is not remedied within 2 months of the Office's request in that regard, the application must be rejected as inadmissible (Article 30(1) CDIR).

### **3.5 Locus standi of the applicant**

Any natural or legal person, as well as a public authority empowered to do so, may submit an application for a declaration of invalidity of a Community design to the Office based on Article 25(1)(a) and (b) CDR (Article 52(1) CDR).

However, where the ground for invalidity is lack of entitlement to the RCD pursuant to Article 25(1)(c) CDR, infringement of an earlier right, within the meaning of Article 25(1) (d) to (f) CDR, or improper use of flags and other symbols, within the meaning of Article 25(1)(g) CDR, an application for a declaration of invalidity is admissible only if the applicant is entitled to the earlier right or is affected by use of the symbol, as the case may be (Article 52(1) CDR). Entitlement will be examined on the basis of the international, national or European Union law that governs the earlier right or symbol in question.

For substantiation of the applicant's entitlement, see [paragraph 3.10.2](#) below.

### **3.6 Representatives**

As a matter of principle, the rules governing representation in European Union trade mark proceedings apply *mutatis mutandis* to invalidity proceedings for Community designs (see the Guidelines, Part A, General Rules, Section 5, Parties to the Proceedings and Professional representation).

### **3.7 Identification of the contested Community design**

An application for a declaration of invalidity must contain the registration number of the contested Community design and the name and address of its holder, as entered in the Register (Article 28(1)(a) CDIR).

Where the information given by the applicant does not make it possible to identify the contested Community design unambiguously, the applicant will be requested to supply such information within a period of 2 months. If the applicant does not comply with this request, the application will be rejected as inadmissible (Article 30(1) CDIR).

### 3.8 Lapsed or surrendered registrations

A Community design may be declared invalid even after the Community design has lapsed or has been surrendered (Article 24(2) CDR).

Where the contested Community design has lapsed or has been surrendered on or before the date of filing of the application for a declaration of invalidity, the applicant will be requested to submit evidence, within a period of 2 months, that it has a legal interest in the declaration of invalidity. Where the applicant does not comply with the request, the application is rejected as inadmissible and the fees are not refunded (Article 30(1) CDIR) (16/06/2011, ICD No 8 231).

For instance, legal interest is established where the applicant proves that the holder of the contested Community design has taken steps with a view to invoking rights under the contested Community design against it.

Where the contested Community design has lapsed or has been surrendered in the course of the invalidity proceedings, the applicant will be asked to confirm whether it maintains its application within a period of 2 months and, if so, to submit reasons in support of its request in order to obtain a decision on the merits of the case.

The cases above have to be distinguished from invalidity actions directed against a Community design, which, at the filing date of the application for invalidity, has already been declared invalid by a final decision. In these cases, the later invalidity action is inadmissible and the fees are non-refundable.

### 3.9 Res judicata

An application for a declaration of invalidity is inadmissible if an application relating to the same subject matter and cause of action, and involving the same parties, has been adjudicated on by a **Community design court** and has acquired the authority of a final decision (Article 52(3) CDR). Where this is the case, the invalidity applicant will be invited to comment on the finding before the application is rejected. The invalidity fee is non-refundable.

However, a final decision taken by the **Office**, which was not ruled on in substance by the court in previous invalidity proceedings between the same parties and having the same subject matter and cause of action, is not equivalent to a judgment issued by a Community design court regarding the effects laid down in Article 52(3)CDR (17/05/2018, [T-760/16](#), Fahrradkörbe, EU:T:2018:277, § 29-34).

### 3.10 Statement of grounds, facts, evidence and arguments

The application must include an indication of the grounds on which the application is based (Article 52(2) CDR; Article 28(1)(b)(i) CDIR) together with a reasoned statement

explaining the facts, evidence and arguments in support of those grounds (Article 28(1)(b)(vi) CDIR).

### **3.10.1 Statement of grounds**

Where the applicant uses the form provided by the Office (Article 68(1)(f) CDIR), the indication of the grounds relied on is made by ticking one or several boxes in the field 'Grounds'.

Where the applicant does not use the form provided by the Office, an indication of the relevant subsection of Article 25(1) CDR, such as 'ground of Article 25(1)(a) CDR', will be considered an indication of the grounds invoked.

The Office will examine the application in light of all the grounds put forward in the reasoned statement explaining the facts, evidence and arguments, even if the corresponding boxes in the application form used to lodge the action were not ticked.

Where the application form, together with the reasoned statement explaining the facts, evidence and arguments, does not make it possible to identify unambiguously the ground(s) on which the application is based, the applicant will be requested to provide further specifications in this respect within a period of 2 months. Where the applicant does not comply with the request, the application will be rejected as inadmissible (Article 30(1) CDIR).

Grounds for invalidity, other than those specifically relied on in the application, will be considered inadmissible when subsequently put forward before the Office.

The Office strongly recommends that all grounds for invalidity be put forward in one single application. Where separate applications are lodged against the same contested Community design and based on different grounds, the Office may deal with them in one set of proceedings. The Invalidity Division may subsequently decide to no longer deal with them in this way (Article 32(1) CDIR).

### **3.10.2 Facts, evidence and arguments**

In proceedings relating to a declaration of invalidity, the Office is restricted in its examination to the facts, evidence and arguments submitted by the parties and the relief sought ( [Article 63\(1\) CDR](#) ).

As a matter of principle, all facts, evidence and arguments relied on in support of an application for a declaration of invalidity must be submitted together with the application.

The applicant must submit the following facts, evidence and arguments in support of the ground(s) on which the application is based ( [Article 28\(1\)\(b\)\(vi\) CDIR](#) ) for the application to be deemed admissible ( [Article 30\(1\) CDIR](#) ) - each ground must be supported by its own set of facts, evidence and arguments.



- Where the applicant claims that the contested Community design **lacks novelty or individual character** ( [Article 25\(1\)\(b\) CDR](#)), the application must contain a representation of the earlier design(s) that could form an obstacle to the novelty or individual character of the contested Community design, as well as documents proving the existence of the earlier design(s) ( [Article 28\(1\)\(b\)\(v\) CDIR](#) ).

[Article 28\(1\)\(b\)\(v\) CDIR](#) requires that evidence of the existence and identification of the earlier design(s) be filed together with the application for a declaration of invalidity (and no later), so that the holder of the contested design can, without delay, take a position on the merits of the action. For this reason, it is a condition for the admissibility of the application for a declaration of invalidity ( [Article 30\(1\) CDIR](#) ; 21/09/2017, [C-361/15 P](#) & [C-405/15 P](#) Shower drains, EU:C:2017:720, § 65).

For more information on the particulars proving disclosure the applicant must comply with, see paragraph [5.7.1 Disclosure of the earlier design](#) .

- Where the applicant claims that the holder is **not entitled to the contested Community design** ( [Article 25\(1\)\(c\) CDR](#), the application must contain particulars showing that the applicant is entitled to the contested Community design by virtue of a court decision ( [Article 28\(1\)\(c\)\(iii\) CDIR](#) ).
- Where the applicant claims that the contested Community design is in conflict with a **prior design** ( [Article 25\(1\)\(d\) CDR](#)), the prior design right must be identified. The application must contain a representation of and particulars identifying the prior design, including evidence of any priority claims. Furthermore, the application must contain evidence proving that the applicant is entitled to invoke the prior design as a ground for invalidity ( [Article 28\(1\)\(b\)\(ii\) CDIR](#) ).
- Where the applicant claims that the contested Community design infringes an **earlier right**, namely that it makes unauthorised use of a **distinctive sign** ( [Article 25\(1\)\(e\) CDR](#) ) or a work protected by **copyright** in a Member State ( [Article 25\(1\)\(f\) CDR](#) ), the application must contain a representation and particulars identifying the distinctive sign or the work protected by copyright. Furthermore, the application must contain evidence proving that the applicant is the holder of the earlier right in question ( [Article 28\(1\)\(b\)\(iii\) CDIR](#) ).

Where the earlier right invoked under [Article 25\(1\)\(d\) or \(e\) CDR](#) is **registered**, a distinction is to be made depending on whether the earlier right is an RCD, an EUTM or a different type of protected right.

- If the earlier right is an RCD or an EUTM, the applicant does not have to submit any documents — examination of the existence will be based on the data contained in the Office's Register.
- In all other cases, the applicant must provide the Office with evidence of the existence, validity and scope of protection of the earlier right. The following documents will be accepted: 1) certificates issued by the competent registration authorities; 2) extracts from the official databases of the competent registration authorities; 3) extracts from official bulletins of the competent registration



authorities. In addition, the Office accepts, as evidence for national marks/designs and international registrations, extracts obtained through the Office's *TMview* portal ( <https://www.tmdn.org/tmview/welcome> ) and *DesignView* portal (<https://www.tmdn.org/tmdsview-web/#/dsview>). Extracts generated through *TMview* reflect the information obtained directly from the competent registration authorities and therefore qualify as documents equivalent to filing or registration certificates from the competent registration authorities within the meaning of [Article 7\(2\)\(a\) EUTMDR](#), provided that the extract contains all the relevant information (06/12/2018, [T-848/16](#), V (fig.) / V (fig.) et al., EU:T:2018:884, § 59-61, 70). The same applies, *mutatis mutandis*, to extracts generated through *DesignView*.

Applicants must carefully check that the relevant official online database is up to date and contains all the relevant information necessary to prove the validity and scope of protection of the earlier right invoked in the application for invalidity. When the extract from an official database or the database accessed online does not contain all the information required, the applicant must supplement it with other documents from an official source that show the missing information.

Where an earlier right is **pending registration**, the applicant must complete the file by submitting evidence of actual registration of the earlier right relied upon once registered. Until that time it is sufficient to submit a copy of the application with the stamp of the receiving office. If necessary, prior to making a decision, the Office may suspend the invalidity proceedings until it has received evidence of registration (see [paragraph 4.1.6.2](#) ).

Where the earlier right invoked under [Article 25\(1\)\(e\) or \(f\) CDR](#) is **unregistered**, this condition will be considered to be complied with for the purpose of examining the admissibility of the application, where the applicant submits evidence that the earlier distinctive sign or the earlier work protected by copyright law has been used or disclosed, as the case may be, under the applicant's name before the date of filing or the priority date of the Community design (see paragraphs 5.7.3 and 5.8.1 for substantiation of the proprietorship of the earlier right relied on under [Article 25\(1\)\(e\) and \(f\) CDR](#) ).

- Where the applicant claims that the contested Community design makes improper use of any of the items listed in **Article 6 *ter* of the Paris Convention** or of badges, emblems and escutcheons other than those covered by Article 6 *ter* and which are **of particular interest in a Member State ( [Article 25\(1\)\(g\) CDR](#) )** , the application must contain a representation and particulars of the relevant item, and particulars showing that the application is filed by the person or entity affected by the improper use ( [Article 28\(1\)\(b\)\(iv\) CDIR](#) ).

If the applicant fails to submit, together with the application, all the particulars listed above, the Office will issue a deficiency letter requesting the facts, evidence and arguments. If the applicant does not comply with this request, the application will be rejected as inadmissible in whole or in part (in relation to the particular ground(s), design(s) or right(s) invoked) under [Article 30\(1\) CDIR](#) .

Unless the Office has sent a deficiency letter pursuant to [Article 30\(1\) CDIR](#), new evidence concerning the indication and reproduction of the earlier design(s) or right(s) can no longer be submitted. Additional particulars or new grounds of invalidity submitted after the notification of the application will be rejected as inadmissible to the extent that they would broaden the scope of the original application for a declaration of invalidity (05/02/2016, [R 2407/2014-3](#), Kitchen utensils, § 21; 22/10/2009, [R 690/2007-3](#), Chaff cutters, § 44 et seq.).

Where the evidence in support of the application is not filed in the language of proceedings, the applicant must, on its own motion, submit a translation of that evidence into that language within 2 months of the filing of such evidence ( [Article 29\(5\) CDIR](#)). The question whether certain parts of the supporting documents may be considered irrelevant for the application, and therefore not translated, is a matter for the discretion of the applicant. In cases where a translation is not submitted, the Invalidity Division may disregard the text portions of the evidence that are not translated and base its decision solely on the evidence before it that has been translated into the language of proceedings ( [Article 31\(2\) CDIR](#) ).

Documents in support of an application should be listed in a schedule of annexes appended to the application itself. As best practice, the schedule of annexes should indicate, for each document annexed, the number of the annex (Annex A.1, A.2, etc.), a short description of the document (e.g. 'letter') followed by its date, the author(s) and the number of pages, and the page reference and paragraph number in the submission where the document is mentioned and its relevance is described.

The documents annexed to a submission must be paginated. This is to ensure that all pages of the annexes have been duly scanned and communicated to the other parties.

An assessment on the **substance** of the above facts, evidence and arguments is carried out by the Invalidity Division at a later stage when a decision is taken.

### **3.10.3 Admissibility in respect of one of the grounds or the earlier rights or prior designs relied on**

An application based on more than one ground for invalidity, or more than one earlier right or prior design, is found to be admissible if and insofar as the requirements regarding admissibility are satisfied for at least one of those grounds, and in relation to at least one earlier right or prior design, irrespective of whether or not these requirements are met for the remaining grounds and earlier rights or prior designs.

Since there is no additional time limit granted for substantiation, all the details must be provided in the application. Therefore, from the outset the applicant must submit a complete application for invalidity containing the necessary details required pursuant to Article 28(1) CDIR, including the facts, evidence and arguments in relation to all the ground(s) and the earlier right(s) or the prior design(s) invoked (see [3.10.2 Facts, evidence and arguments](#)).

For reasons of procedural economy when examining the admissibility of the application, the Office may choose not to examine whether all the grounds and earlier rights or prior designs invoked in the application are admissible. Instead it may choose to limit the examination to one ground and one earlier right or prior design. Consequently, the applicant will not be invited to remedy admissibility deficiencies if and insofar as the requirements regarding admissibility are satisfied for at least one of those grounds and in relation to at least one earlier right or prior design. The exception to this rule concerns the grounds of Article 4(1) CDR. If a statement is made that the application for invalidity is based on the ground of novelty and/or individual character, the admissibility examination must ensure that the scope of the application is clear. In case of any doubts, the Office will invite the invalidity applicant to clarify if only novelty, individual character or both grounds are invoked, and which prior designs are relevant with respect to each of the grounds.

Where the application is inadmissible in its entirety, the Office will call upon the invalidity applicant to remedy the admissibility deficiencies within 2 months. If the applicant fails to remedy the deficiencies, the application will be rejected as inadmissible (Article 30(1) CDIR).

The Office assesses the facts, evidence and arguments on the merits of the case at a later stage when a decision is taken. Where the invalidity application does not succeed on the ground and earlier right or the prior design found to be admissible, the Office will examine whether the remaining grounds(s) and earlier rights(s) or prior design(s) are admissible.

If necessary, it will call upon the invalidity applicant to remedy the admissibility deficiencies concerning the remaining earlier rights or prior designs and grounds within 2 months.

Where the deficiencies are remedied in due time, the holder will be invited to submit observations in that respect before the decision on substance is taken. The Office will then decide on the merits of the case based on those remaining ground(s) and earlier rights(s) or prior designs found admissible.

Where the applicant does not comply with the request, the admissibility issue will be dealt with together with the decision on the merits of the case.

The decision on admissibility of the invalidity application can be appealed together with the final decision terminating the proceedings (Article 55(2) CDR).

### **3.11 Signing the application**

The application for a declaration of invalidity must be signed by the applicant or its representative if it has one (Article 65(1) CDIR).

Where the signature is missing, the Office will request the applicant to remedy the deficiency within 2 months. If the applicant does not comply with the request, the application will be rejected as inadmissible (Article 30(1) CDIR). If the application is filed by electronic means, the indication of the name of the sender is deemed

equivalent to a signature. For further details on signatures, see the Guidelines [Part A, General Rules, Section 1, Means of Communication, Time Limits, paragraph 3.1.4.](#)

### 3.12 Means of filing

An application for a declaration of invalidity may be filed with the Office by e-filing through the User Area on the Office's website (Decision No [EX-20-9](#) of the Executive Director of the Office of 3 November 2020 on communication by electronic means), by post or by personal delivery (Decision No [EX-18-5](#) of the Executive Director of the Office of 3 September 2018 concerning the hours the Office is open to receive submissions by personal delivery relating to RCDs).

Fax is expressly identified as a means of communication in all procedures relating to Community designs in [Article 47\(2\)\(d\) CDIR](#) and [Article 51 CDIR](#). However, pursuant to Article 2 of Decision No [EX-20-9](#) of the Executive Director on communication by electronic means, **fax can no longer be offered and will no longer be used**, as a means of communication in procedures before the Office, due to technical limitations and malfunctions affecting the reliability and preventing the uninterrupted functioning of communications by fax (and that lie beyond the Office's control).

In the event of a malfunction during the electronic transmission of an application, communication or other document through the specific e-operation or e-filing via the User Area, the Office has made two electronic backup alternatives available:

1. an upload solution located in the Communications section of the User Area; this is a general upload platform that allows documents to be attached and sent to the Office.
2. a file-sharing solution outside the User Area; the Office will provide the account holder with access to a secure file-sharing location where the document(s) in question can be uploaded.

Technical details on the accessibility and functionality of both backup alternatives are available in the Conditions of Use of the User Area. For more information on communication via the User Area, see the Guidelines, [Part A, General Rules, Section 1, Means of communication, time limits, paragraph 3.1.1.](#)

### 3.13 Payment of fees

For general rules on payments, see the Guidelines, [Part A, General Rules, Section 3, Payment of Fees, Costs and Charges.](#)

An application for a declaration of invalidity will be deemed not to have been filed until the fee has been paid in full ([Article 52\(2\) CDR](#); [Articles 28\(2\) and 30\(2\) CDIR](#)). Therefore, before examining the admissibility of the application, the Office will first check that the fee has been received.

Where the Office finds that the fee has not been paid, it will request that the applicant pay the fee within a period of 2 months of receipt of the notification. If the applicant

does not comply with the request, the application is deemed not to have been filed and the applicant is informed accordingly. If the required fee is paid after the expiry of the time limit specified, it will be refunded to the applicant ([Article 30\(2\) CDIR](#)).

In cases where the fee is received after the expiry of the time limit specified by the Office but the applicant provides proof that, within the time limit, it duly gave an order to a banking establishment to transfer the amount of the payment in a Member State, [Article 7\(3\) CDFR](#) will be applied, including the payment of a surcharge where applicable (see the Guidelines, [Part A, General Rules, Section 3, Payment of Fees, Costs and Charges](#)).

The filing date of an application for a declaration of invalidity is not affected by the date of payment of the fee since [Article 52\(2\) CDR](#) does not provide for any consequence as regards the filing date of the application. When the fee is paid before the expiry of the time limit specified by [Article 30\(2\) CDIR](#), the application is deemed to have been filed and the filing date will be the date the application was received by the Office.

As a general principle, the invalidity fee is an application fee due for the filing of the application regardless of the outcome of the proceedings. Therefore, it will not be refunded if the application is rejected as inadmissible or withdrawn in the course of proceedings.

### **3.14 Decision to the effect that the application is inadmissible**

Where the Office finds the application inadmissible and the deficiency is not remedied within the specified time limit, it will issue a decision rejecting the application as inadmissible (Article 30(1) CDIR). The fee will not be refunded.

### **3.15 Decision to the effect that the application is admissible and communication to the holder**

When the application for a declaration of invalidity is submitted via e-filing, the RCD holder receives an automated acknowledgement of receipt.

The notification of an application for a declaration of invalidity, constituting the decision on the admissibility of an application for a declaration of invalidity, is issued to the RCD holder only after the application has been found admissible (Article 31(1) CDIR). This decision can be appealed together with the final decision (Article 55(2) CDR).

The decision on admissibility may, however, be withdrawn, in accordance with the general principles of administrative and procedural law, if irregularities are detected *ex officio* by the Office, within a reasonable time, or by the RCD holder in its first observations (Article 31(1) CDIR), and if the applicant for invalidity fails to remedy such irregularities within the time limit prescribed by the Office (Article 30 CDIR) (Article 68 CDR and, by analogy, 18/10/2012, [C-402/11 P](#), Redtube, EU:C:2012:649, § 59).

Where the Office does not reject the application as inadmissible, the application is communicated to the holder and a time limit of 2 months for submitting observations in response to the application is granted (see below under [4.1.1 Observations by the holder](#)).

### **3.16 Participation of an alleged infringer**

As long as no final decision has been taken by the Invalidity Division, any third party that proves that proceedings for infringement based on the contested Community design have been instituted against it can join as a party to the invalidity proceedings (Article 54 CDR; Article 33 CDIR).

The alleged infringer must submit its request to be joined as a party within 3 months of the date on which the infringement proceedings were instituted. Unless proof is submitted by the holder that another date should be retained in accordance with the national law in question, the Office will assume that proceedings are 'instituted' on the date of service of the action to the alleged infringer. The alleged infringer must submit evidence in respect of the date of service of the action.

Any third party that proves that (i) the rights holder of the Community design has requested that it cease an alleged infringement of the design and that (ii) the third party in question has instituted proceedings for a court ruling that it is not infringing the registered Community design (if actions for declaration of non-infringement of Community designs are permitted under national law) may also join as a party in the invalidity proceedings (Article 54 and Article 81(b) CDR).

The request to be joined as a party must be submitted in a written reasoned statement and will not be deemed to have been submitted until the invalidity fee has been paid. The rules explained above in paragraphs [3.1 Form of the application](#) to [3.13 Payment of fees](#) will apply to the alleged infringer (Article 54(2) CDR; Article 33 CDIR).

## **4 Adversarial Stage of the Proceedings**

### **4.1 Exchange of communications**

#### **4.1.1 Observations by the holder**

##### **4.1.1.1 Generalities**

The holder's observations will be communicated to the applicant without delay (Article 31(3) CDIR).

Documents in support of observations should be listed in a schedule of annexes (see [paragraph 3.10.2](#) above).

The holder should submit its observations (including supporting documents) in duplicate when not using e-filing (see [paragraph 3.1](#) above).

Where the holder submits no observations within the 2-month time limit, the Invalidity Division will notify the parties that the written phase of the proceedings is closed and that it will take a decision on the merits on the basis of the evidence before it (Article 31(2) CDIR).

#### 4.1.1.2 Request for proof of use of an earlier trade mark

A request for proof of use of an earlier trade mark during the 5 years preceding the date of the application for a declaration of invalidity may be submitted by the holder if the following cumulative conditions are complied with:

- the application is based on Article 25(1)(e) CDR;
- the earlier distinctive sign is a (European Union, international or national) trade mark having effect in the European Union that, on the date of the application for a declaration of invalidity, has been registered for not less than 5 years;
- the request for proof of use is explicit and is submitted together with the holder's first submission in response to the application (12/05/2010, [T-148/08](#), Instruments for writing, EU:T:2010:190, § 66-72; 27/06/2013, [T-608/11](#), Instruments for writing, EU:T:2013:334, § 87; 15/11/2013, [R 1386/2012-3](#), CINTURONES, § 21).

### 4.1.2 Translation of the holder's observations

Where the language of proceedings is not the language of filing of the contested Community design, the holder may submit its observations in the language of filing (Article 98(4) CDR; Article 29(2) CDIR). The Office will arrange to have those observations translated into the language of proceedings, free of charge, and will communicate the translations to the applicant without delay.

### 4.1.3 Scope of defence

The holder's observations must include an indication regarding the extent to which it defends the contested Community design. Where the holder does not give such an indication, it is assumed that it seeks maintenance of the Community design in the form as originally registered, that is, in its entirety.

Where the holder requests that the Community design be maintained in an amended form, the request must include the amended form. The amended form must comply with the requirements for protection, and the identity of the Community design must be retained. 'Maintenance' in an amended form may include registration accompanied by a partial disclaimer by the holder or entry in the Register of a court decision or a decision by the Invalidity Division declaring the partial invalidity of the Community design (Article 25(6) CDR) (see [paragraph 5.10](#) below).



The request to maintain the contested Community design in an amended form must be submitted during the invalidity proceedings and before the end of the written phase. The applicant will be given the opportunity to comment on whether the Community design in its amended form complies with the requirements for protection and whether the identity of the Community design is retained.

The decision on the maintenance of the Community design in an amended form will be included in the decision on the merits terminating the invalidity proceedings.

#### **4.1.4 Reply by the applicant**

##### **4.1.4.1 Generalities**

Where the parties' submissions allow the Office to base its decision on the evidence before it, the Office will notify the parties that the written phase of the proceedings is closed.

However, the applicant will be allowed to reply to the holder's observations within a time limit of 2 months (Article 53(2) CDR; Article 31(3) CDIR) in particular under the following circumstances:

- where the holder's observations contain additional facts, evidence and arguments that are prima facie relevant for a decision on the merits; or
- where the holder requests to maintain the Community design in an amended form; or
- where the holder requested proof of use of the earlier trade mark relied on under Article 25(1)(e) CDR.

Any reply from the applicant will be communicated to the holder (Article 31(4) CDIR). Where the applicant's reply is considered admissible, the holder will be invited to submit a rejoinder (Article 53(2) CDR).

Where the applicant does not reply within the specified time limit, the Office will notify the parties that the written phase of the proceedings is closed and that it will take a decision on the merits on the basis of the evidence before it (Article 31(2) CDIR).

The subject matter of the proceedings must be defined in the application (see paragraph 3.10 above). Reliance on additional earlier designs and/or rights is inadmissible when submitted at the belated procedural stage of the reply if the effect is to alter the subject matter of the proceedings (22/03/2019, [R 1283/2018-3](#), Goggles (part of-), § 18; 05/02/2016, [R 2407/2014-3](#), Kitchen utensils, § 21; 22/10/2009, [R 690/2007-3](#), Chaff cutters, § 44 et seq.). The admissibility of additional facts, evidence and arguments relating to earlier designs and/or rights already referred to in the application is subject to the discretionary powers conferred on the Office under Article 63(2) CDR (see [paragraph 2.4](#) above).

The applicant should submit its reply in duplicate when not using e-filing (see [paragraph 3.1](#) above).



#### 4.1.4.2 Translation of the applicant's reply

Any reply of the applicant must be in the language of proceedings. Where the applicant has been invited to reply and its reply is not in the language of proceedings, the applicant must submit, on its own motion, a translation of its reply within 1 month of the date of the submission of the original reply (Article 81(1) CDIR). The Office will not remind the applicant of its duty in this respect. Where the applicant submits the translation on time, it will be communicated to the holder. Where the applicant does not submit the translation on time, its reply will be deemed not to have been filed.

#### 4.1.4.3 Submission of evidence of use of an earlier trade mark

Where the applicant is requested to submit evidence of use of its earlier trade mark, it must submit such evidence (i) in connection with the goods or services in respect of which this trade mark is registered, and which the applicant cites as justification for its application and (ii) in respect of the period of 5 years preceding the date of the application for a declaration of invalidity, unless there are proper reasons for non-use. Such reasons for non-use must be substantiated.

Evidence of use of an earlier mark must fulfil **all** the cumulative conditions imposed by [Article 10\(3\) EUTMDR](#), that is, indications concerning **the place, time, extent and nature** of use of the earlier trade mark for the goods and services for which it is registered and on which the application is based.

Where the language of the documents submitted by the applicant is not the language of the proceedings, the Office may require that a translation be supplied in that language, within 1 month, or 2 months if the applicant does not have its domicile or its principal place of business or an establishment within the European Union (Articles 57(1) and 81(2) CDIR).

In the absence of proof of genuine use of the earlier trade mark (unless there are proper reasons for non-use), or in the absence of a translation if so required by the Office, the application for a declaration of invalidity will be rejected to the extent that it was based on Article 25(1)(e) CDR.

When examining the evidence of use, the Office will apply the principles explained in the Guidelines, Part C, Opposition, Section 7, Proof of use.

### 4.1.5 End of exchange of observations

Where the parties' observations do not contain additional facts, evidence or arguments that are prima facie relevant for a decision on the merits, and additional observations are not necessary, the Office will inform both parties that the written proceedings are closed and that a decision will be taken on the basis of the evidence before it (Article 53(2) CDR).

Facts, evidence or arguments submitted after notification to the parties that the written phase of the procedure is closed will be considered inadmissible, save in exceptional

circumstances, for example, where the evidence was unavailable at an earlier stage or where a fact came to light in the course of the proceedings (Article 63(2) CDR, see [paragraph 2.4](#) above).

## 4.1.6 Extension of time limits and suspension

### 4.1.6.1 Extension of time limits

Requests by any of the parties for an extension of a time limit determined by the Office must be submitted before the original time limit expires (Article 57(1) CDIR).

As a general rule, a first request for extension of a time limit will be granted. Further extensions will not be granted automatically. In particular, the Office may make the extension of a time limit subject to the agreement of the other party or parties to the proceedings (Article 57(2) CDIR).

Reasons in support of any further request for extension must be submitted to the Office. The request for an extension of the time limit must indicate the reasons why the **parties** cannot meet the deadline. Obstacles faced by the parties' **representatives** do not justify an extension (see, by analogy, 05/03/2009, [C-90/08 P](#) , *Corpo livre*, EU:C:2009:135, § 20-23).

Where a request for extension of an extendable time limit has been filed and received before the expiry of the time limit (30/01/2014, [C-324/13 P](#) , *Patrizia Rocha*, EU:C:2014:60), the party concerned will be granted at least 1 day, even if the request for extension arrived on the last day of the time limit.

The extension will not result in a time limit longer than 6 months (Article 57(1) CDIR). Both parties are informed about any extension.

For more information on time limits see [Part A, General Rules, Section 1, Means of Communication, Time Limits](#) .

### 4.1.6.2 Suspension

The Office will suspend the proceedings on its own motion after hearing the parties, unless there are special grounds for continuing the proceedings, where it has been brought to the attention of the Office that the validity of the contested Community design is already in issue on account of a counterclaim before a competent national court, and the national court does not stay its proceedings (Article 91(2) CDR).

The Office may also suspend the proceedings when it is appropriate, in particular in the circumstances listed here.

- Where the request for a declaration of invalidity is based on an earlier design or trade mark for which the registration process is pending, until a final decision is taken in those proceedings (Article 25(1)(d) and (e) CDR).

- Where the request for a declaration of invalidity is based on an earlier design, trade mark or other earlier right, the validity of which is challenged in administrative or in court proceedings, until a final decision is taken in those proceedings.
- Where the Office receives a joint request for suspension signed by both parties with a view to reaching an amicable settlement (Article 31(5) CDIR).
- Where a number of applications for a declaration of invalidity have been filed relating to the same Community design, and where a preliminary examination reveals that the Community design may be invalid on the basis of one of these applications. The Office will deal with this application first and may suspend the other invalidity proceedings (Article 32(2) CDIR).

The Office has broad discretionary powers when deciding on the appropriateness of the suspension. The decision on the suspension must take into account the balance between the parties' respective interests, including the applicant's interest in obtaining a decision within a reasonable period of time (see, by analogy, 16/05/2011, [T-145/08](#), Atlas, EU:T:2011:213, § 68-77).

The Office will notify the parties of its decision to grant or refuse a suspension, giving reasons and explaining which factors it considers when exercising its discretion. Where the Office decides not to grant the suspension, reasons may instead be given in the decision terminating the proceedings. Where a suspension is granted for a determined period, the Office will indicate in its communication the date of resumption of the proceedings. The proceedings will resume the day after the expiry of the suspension.

Where a suspension is granted for an undetermined period, the invalidity proceedings will be resumed when the parties inform the Office or when it has been brought to the attention of the Office that the event that justified the stay has occurred, or ceased to exist, as the case may be. The date of resumption will be indicated in the communication of the Office or, in the absence of such indication, on the day following the date of that communication.

Where the suspension was requested jointly by the parties, the period will always be 6 months regardless of the period requested by the parties. Any party can bring the suspension to an end ('opting out'). It is immaterial whether the other party disagrees with or has consented to it.

If one of the parties 'opts out', the suspension will end 2 weeks after the parties have been informed thereof. The proceedings will resume the day after.

Where a time limit was running at the time of the suspension, the party concerned will be given 2 months from the date of resumption of the proceedings to submit its observations.

#### **4.1.7 Taking of evidence**

The parties may submit evidence in the form of documents and items of evidence, opinions by experts and witnesses, and/or statements in writing, sworn or affirmed or having a similar effect under the law of the state in which the statement is drawn up (Article 65(1) CDR).

Where a party offers evidence in the form of witness statements or expert opinions, the Office will invite the party to provide the statement of the witness or the opinion of the expert in writing, except where a hearing is considered expedient (Article 65 CDR; Articles 43 and 46 CDIR).

For more information see the Guidelines [Part A, General Rules, Section 2, General Principles to be Respected in the Proceedings, paragraph 4, Means of taking evidence.](#)

#### **4.1.8 Oral proceedings**

Oral proceedings may be held at the request of the Office or of any of the parties (Article 64 CDR; Article 38(1) and Article 42 CDIR).

Where a party requests that they be held, the Office enjoys broad discretionary powers as to whether oral proceedings are really necessary. A hearing will not be held when the Office has before it all the information needed as a basis for the operative part of the decision on invalidity (13/05/2008, [R 135/2007-3](#), *Macchine da gioco automatiche*, § 14).

The Office will apply the principles explained in the Guidelines, [Part A, General Rules, Section 2, General Principles to be Respected in the Proceedings, paragraph 5, Oral proceedings.](#)

### **4.2 Examination**

#### **4.2.1 Commencement of examination**

The Invalidity Division begins with the examination of the application as soon as the parties are informed that the written phase of the procedure is closed and that no further observations can be submitted (Article 53 CDR).

#### **4.2.2 Examination of the grounds for invalidity**

The grounds for declaring a Community design invalid are listed exhaustively in Article 25 CDR. An application for a declaration of invalidity based on a ground other than those listed in the CDR (e.g. a claim that the holder was acting in bad faith when applying for the registered Community design) will be rejected as inadmissible as far as the ground in question is concerned (18/03/2010, [T-9/07](#), *Metal rappers*, EU:T:2010:96, § 30-31).

The selection and indication of a ground or grounds of invalidity in the application form is a valid declaration of the ground(s) on which the application is based.

The Office must, however, examine an application in the light of all grounds put forward in the statement of grounds, even if the corresponding boxes in the application form

were not ticked. Therefore, where the applicant indicated in the statement of grounds that the contested Community design was 'not novel', that indication constitutes a valid statement of grounds even if the 'Grounds' box concerning the requirements of Articles 4 to 9 CDR was not ticked (02/08/2007, [R 1456/2006-3](#), Saucepan handles, § 10).

The examination will not be extended to grounds not relied on in the application. Where an applicant exclusively invokes, for instance, either the novelty or the individual character of a Community design as a ground for invalidity, the Office will only examine the ground invoked (14/03/2018, [T-424/16](#), Footwear, EU:T:2018:136, § 47).

The applicant cannot raise new grounds for invalidity after the notification of the invalidity application (10/02/2016, [R 1885/2014-3](#), Logos, § 15-19). However, the applicant may file another application for a declaration of invalidity based on the same or different grounds.

Where the application can be upheld on the basis of one of several grounds put forward by the applicant, the Invalidity Division will not take a decision on the others (15/12/2004, ICD No 321). Where an application can be upheld on account of the existence of one of the earlier designs or rights relied on by the applicant, the remaining earlier designs or rights will not be examined (14/06/2011, [T-68/10](#), Watches, EU:T:2011:269).

Where the application cannot be upheld on the basis of one of the several grounds or one of the earlier designs or rights found to be admissible, the Office will examine the remaining grounds and rights or prior designs and reopen the admissibility where necessary (see [paragraph 3.10.3](#), Admissibility in respect of one of the grounds or the earlier right or prior designs relied on).

For the examination of the substantive requirements concerning the validity of a priority claim in the course of invalidity proceedings, see the Guidelines, [Examination of Applications for Registered Community Designs, paragraph 6.2.1.1, Priority](#).

## 5 The Different Grounds for Invalidity

### 5.1 Not a design

According to Article 25(1)(a) CDR, a Community design may be declared invalid if the design does not correspond to the definition under Article 3(a) CDR. This would be the case where the views of the Community design are inconsistent and represent different products (other than forming a 'set of products', see Article 3 CDR and [the Guidelines, Examination of Applications for Registered Community Designs](#), Additional requirements regarding the reproduction of the design, [paragraph 5.3.7, Sets of articles](#)), or where the graphical representation consists of mere representations of nature (landscapes, fruits, animals, etc.) that are not products within the meaning of Article 3(1)(b) CDR.

### 5.1.1 Living organisms

A design that discloses the appearance of a living organism in its natural state, in principle, has to be refused. Even if the shape at issue deviates from that of the common corresponding living organism, the design should be refused if nothing suggests prima facie that the shape is the result of a manual or industrial process (see, by analogy, 18/02/2013, [R 595/2012-3](#), GROENTE EN FRUIT, § 11).



A Community design will not be declared invalid if it is apparent from the representation that the product does not show a living organism or if the indication of the product specifies that the product is artificial (see, in particular, Class 11-04 of the Locarno Classification).

### 5.1.2 Ideas and methods of use

The law relating to designs protects the appearance of the whole or a part of a product, but does not protect the underlying idea of a design (06/06/2013, [T-68/11](#), Watch-dials, EU:T:2013:298, § 72). Nor is the method of use or operation protected by a design (21/11/2013, [T-337/12](#), Sacacorchos, EU:T:2013:601, § 52).

## 5.2 Contrary to public policy or morality

According to Article 25(1)(b) CDR, a Community design may be declared invalid if it does not fulfil the requirements of Article 9 CDR.

The Office will apply the concepts of public policy and morality as explained in the Guidelines, [Part B, Examination, Section 4, Absolute Grounds for Refusal](#).

## 5.3 Lack of entitlement

According to Article 25(1)(c) CDR, a Community design may be declared invalid if, by virtue of a court decision, the rights holder is not entitled to the Community design under Article 14 CDR.

This ground may be invoked solely by the person who is entitled to the Community design under Article 14 CDR.

In the absence of a court decision, the Invalidity Division cannot declare the contested Community design invalid under Article 25(1)(c) CDR (11/02/2008, [R 64/2007-3](#), Loudspeakers, § 15).

It is clear from the words ‘by virtue of a court decision’ in Article 25(1)(c) CDR that the Invalidity Division has no jurisdiction to determine who is entitled to a Community design under Article 14 CDR. Such jurisdiction belongs to any national court that is competent under Article 27 and Article 79(1) and (4) CDR in conjunction with Article 93 CDR.

As to a change of ownership of the RCD, reference is made to Guidelines, [Part E Register operations, Section 3, EUTMs and RCDs as objects of property, Chapter 2, Licences, rights in rem, levies of execution, insolvency proceedings, entitlement proceedings or similar proceedings, 8.2 Entitlement proceedings for RCDs](#).

## 5.4 Invisible component parts of complex products

Features of a Community design applied to, or incorporated in, a ‘component part of a complex product’, will be disregarded if they are invisible during normal use of the complex product in question (Article 4(2) CDR).

‘Complex product’ means a product that is composed of multiple components that can be replaced, permitting disassembly and reassembly of the product (Article 3(c) CDR). For instance, the visibility requirement does not apply to a Community design representing the appearance of a dustbin as a whole, since dustbins may be complex products as such, but not component parts of complex products (23/06/2008, ICD No 4 919).

‘Normal use’ means use by the end user, excluding maintenance, servicing or repair work (Article 4(3) CDR). ‘Normal use’ is the use made in accordance with the purpose for which the complex product is intended.

For instance, for safety reasons, an electrical connector is a component part that is normally incorporated in a casing in order to be shielded from any contact with potential users when a complex product, such as a train or an electric vehicle, is in operation. The fact that this component part of a complex product can theoretically be made visible when inserted in a transparent casing or cover constitutes a purely hypothetical and random criterion that must be disregarded (03/08/2009, [R 1052/2008-3](#), Contacteurs électriques, § 42-53).

Where none of the features of a Community design applied to a component part (e.g. a sealing ring) is visible during normal use of the complex product (e.g. a heat pump system), the Community design will be invalidated as a whole (20/01/2015, [T-616/13](#), Heat Exchanger Inserts, EU:T:2015:30, § 14-16).

However, Article 4(2) CDR does not require a component part to be clearly visible in its entirety at every moment of use of the complex product. It is sufficient if the whole of



the component can be seen some of the time in such a way that all its essential features can be apprehended (22/10/2009, [R 690/2007-3](#), Chaff cutters, § 21).

## 5.5 Technical function

Article 8(1) CDR provides that ‘a Community design shall not subsist in features of appearance of a product which are solely dictated by its technical function’.

Those features of a design which are found solely dictated by the technical function are excluded from protection and not taken into consideration for the purpose of assessing whether other features of the design fulfil the requirements for protection (Recital 10 CDR; 18/11/2020, [T-574/19](#), Fluid distribution equipment, EU:T:2020:543, § 23).

### 5.5.1 Rationale

The aim of Article 8(1) CDR is to prevent technological innovation from being hampered by the granting of design protection to features dictated solely by a technical function of a product (08/03/2018, [C-395/16](#), DOCERAM, EU:C:2018:172, § 29).

Article 8(1) CDR read together with Article 25(1)(b) CDR provide that an RCD is invalid **as a whole** if it is shown that it consists exclusively of features of appearance of a product which were solely dictated by its technical function, even if other designs fulfilling the same function exist (08/03/2018, [C-395/16](#), DOCERAM, EU:C:2018:172, § 32).

If **at least one** of the features of appearance of the product covered by a contested design is not solely dictated by the technical function of that product, the design cannot be declared invalid under Article 8(1) CDR (24/03/2021, [T-515/19](#), Building blocks from a toy building set, EU:T:2021:155, § 96).

Article 8(1) CDR will also be ruled out if:

- the RCD holder establishes that considerations other than the need for that product to fulfil its technical function, in particular those related to the visual aspect, have played a role in the choice of those features (08/03/2018, [C-395/16](#), DOCERAM, EU:C:2018:172, § 31) (though this does not mean that a design must have an aesthetic quality (recital 10 CDR)); or
- the RCD holder establishes that the RCD concerns a design that serves to facilitate the multiple assembly or connection of mutually interchangeable products within a modular system (see paragraph [5.5.2.5](#)).

### 5.5.2 Examination

Applying Article 8(1) CDR requires a three-step analysis:

- determining the technical function of the product concerned;
- identifying the features of appearance of that product;



- examining, in the light of all the relevant objective circumstances, whether those features are solely dictated by the technical function of the product concerned and, if so, whether the RCD holder has established that other considerations have played a role in the choice of the features (24/03/2021, [T-515/19](#), Building blocks from a toy building set, EU:T:2021:155, § 98).

#### 5.5.2.1 Determining the technical function and the features of appearance of the product

The first step of the examination of Article 8(1) CDR consists of determining which is the relevant product function within the category of products at issue. The relevant category of products is identified by both the product indication (see Examination of applications for registered Community designs, [paragraph 6.1.4](#)), and the design itself (see [paragraph 5.7.2.2](#), Individual character).

The second step consists of determining what the features of appearance are.

The features of appearance of the contested design are examined by the Office, taking into account the parties' submissions (24/03/2021, [T-515/19](#), Building blocks from a toy building set, EU:T:2021:155, § 105-108).

The function performed by the product in which the RCD is incorporated, as well as that of each of its features of appearance, will, in principle, not be examined *ex officio* by the Office and must be explained by the invalidity applicant (Article 63(2) CDR; and [paragraph 5.5.2.2](#), Burden of proof).

#### 5.5.2.2 Appropriate evidence of functionality

Article 8(1) CDR requires an **objective** assessment having regard, in particular, to the design at issue, the objective circumstances behind the reasons that dictated the choice of features of appearance of the product concerned, or information on its use or the existence of alternative designs that fulfil the same technical function. The circumstances, data or information on the existence of alternative designs must, however, be supported by **reliable evidence**.

##### *Burden of proof*

The burden of proof lies with the invalidity applicant who must provide evidence that all the features of the contested design are solely dictated by the technical function of the product concerned (Article 63(1) CDR; 21/09/2017, [C-361/15 P & C-405/15 P](#), Shower drains, EU:C:2017:720, § 60).

##### *Other intellectual property rights in respect of the product concerned*



A design protected by a Community design does not preclude protection by other forms of intellectual property including patents and utility models (Article 96 CDR).

Patents and utility models relied on in invalidity actions based on Article 8(1) CDR need not predate the contested RCD for them to be relevant. Invalidity actions based on

Article 8(1) CDR differ in purpose from the ground under Articles 5 and 6 CDR (novelty and individual character).

Patents or utility models may help to analyse the product incorporating the contested design and identify the elements that make up the product and contribute to its technical function to see if they correspond to the features of its appearance (18/11/2020, [T-574/19](#), Fluid distribution equipment, EU:T:2020:543, § 96). However, the fact that the patent or utility model is granted or applied for for a product with the same or similar appearance, cannot in itself, without further facts, evidence and arguments, establish that all features of the contested design are solely dictated by the technical function of the product (18/11/2020, [T-574/19](#), Fluid distribution equipment, EU:T:2020:543, § 81; 19/10/22, [T-231/21](#), Posts, ECLI:EU:T:2022:649, § 32).

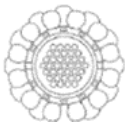
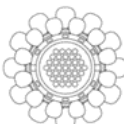
Here are examples of RCDs in which a patent or utility model containing an identical or quasi-identical representation to that of the RCD played a role in the assessment of the features of the product based on Article 8(1) CDR:

	
 <p>Figure 95</p>	
<p>Patent</p>	<p>Contested design 18/11/2020, <a href="#">T-574/19</a>, Fluid distribution equipment</p>

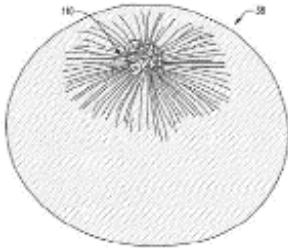
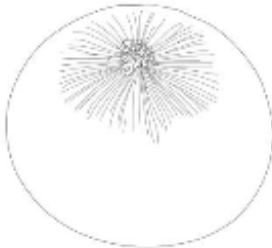
	
<p>Utility model</p>	<p>Contested design 26/01/2022, <a href="#">T-325/20</a>, Water purifiers</p>

A patent or utility model containing a representation that is **different** to that of the RCD may still be relevant if the description or claims made in the document explain why the features that are the same shape as the contested RCD's might achieve the same function.

This result is however not automatic if the parties fail to submit arguments and evidence explaining why all the features of appearance of the contested RCD (including those that are not disclosed in the patent or utility model) are solely dictated by a function. This is illustrated by the following example:

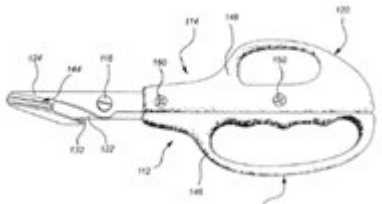
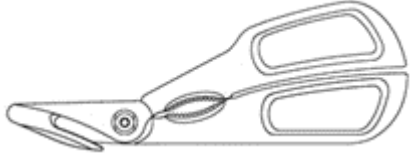
	
Patent	Contested design 10/05/2021, <a href="#">R 440/2020-3</a> , Handheld kitchen cutting appliances

The patent only proved the technical function of the blades pivotally connected and the blade edge curved like a hook, but not that of the rectangular curved shape of the finger rings or the handle shanks in the middle section of the scissors. Given that only part of the features of the contested design were proven to be dictated by the technical function of a pair of scissors within the meaning of Article 8(1) CDR, the application for a declaration of invalidity was rejected.

The drawings in themselves cannot be evidence of technical function but must be read together with the claims and the description of the invention in order to:

- determine whether or not the design contains features which are visible in the drawings of the patent or utility model but whose function is not covered or is not explained by the claims or the description;
- assess whether or not the **appearance** of a given feature may be linked to a technical function (i.e. the shape/position of a specific feature being required to achieve the desired technical result).

#### *Expert opinions and general information on the use of the product*

Expert opinions or any information on the use of the product, in particular that of a technical nature, may serve to illustrate its functioning, including that of its individual features. This information may be contained in the description of the concrete product, promotional material, such as catalogues and brochures, or videos showing its use.

### 5.5.2.3 Examination

The Office will examine whether, in the light of the invalidity applicant's evidence and arguments, each of the features making up the contested RCD is proven to be dictated by the product's function.

The fact that the contested RCD may consist of different features, each of which has a **different function**, may not rule out the application of Article 8(1) CDR. The interpretation of the term 'solely' in this provision does not require that the contested RCD's features must refer to a single technical result (18/11/2020, [T-574/19](#), Fluid distribution equipment, EU:T:2020:543, § 56).

Article 8(1) CDR may apply to shapes where the graphical representation does not disclose **the entirety** of the elements that are necessary for the implementation of the technical solution, provided it is shown that this technical solution requires, in order for the product to operate properly, the essential characteristics which can be seen from the graphical representation.

To put it in simple terms, where a technical function of a product requires the interaction of three elements 'A', 'B' and 'C', Article 8(1) CDR must apply to each of these individual elements if they are filed as an RCD on their own.

Interconnecting features may fall within both Articles 8(1) and 8(2) CDR. Interconnecting features may be solely dictated by the technical function of the product (i.e. to allow it to be connected to and disconnected from another product), unless the RCD holder shows that the features of interconnection were designed in such a way that visual considerations have played a role (24/03/2021, [T-515/19](#), Building blocks from a toy building set, EU:T:2021:155, § 59-63)

If **at least one** of the features of appearance of the product covered by a contested RCD is not solely dictated by the technical function of that product, the RCD cannot be declared invalid under Article 8(1) CDR (24/03/2021, [T-515/19](#), Building blocks from a toy building set, EU:T:2021:155, § 96). The RCD remains on the Register as a whole, that is, as a combination of arbitrary features and solely functional features. Such an RCD is liable to be invalidated on the ground of lack of individual character if the addition of the arbitrary features does not create a sufficiently far-removed impression compared to a prior design, which for this purpose can be disclosed in an earlier patent or utility model (see paragraph [5.7.2](#) Assessment of novelty and individual character, 'Features dictated by a technical function and features of interconnection').

### 5.5.2.4 Defence of the holder

Where each and every feature of the contested RCD is found to be solely dictated by a function because a causal link between its appearance and the function of the product exists according to the principles set out in [paragraph 5.5.2.3 Examination](#), the Office will assume that these features were chosen and combined exclusively for technical reasons.

It is for the RCD holder to submit counter arguments and evidence establishing that considerations of another nature, in particular those related to the visual aspect of the product, have played a role in the choice of those features (Article 63(1) CDR).

#### *Multiplicity of shapes*

The mere existence of alternative designs which fulfil the same technical function cannot, in itself, exclude the finding that all the features of appearance of a product are solely dictated by its technical function (08/03/2018, [C-395/16](#), DOCERAM, EU:C:2018:172, § 32, 37).

Nevertheless, the existence of alternative shapes may in some cases be a relevant indication that considerations other than the technical function of the product have played a role in the choice of features (19/10/22, [T-231/21](#), posts, ECLI:EU:T:2022:649, § 45).

#### *Aesthetic considerations*

A design is not required to have an aesthetic quality (recital 10 CDR; 08/03/2018, [C-395/16](#), DOCERAM, EU:C:2018:172, § 23, 31), however, if it can be established by the RCD holder that it has aesthetic quality, this remains a relevant factor.

Aesthetic considerations must be reflected in an objective manner and cannot be a matter of personal taste. It is for the RCD holder to explain that the choice of features was dictated by more than purely technical considerations and to prove how these features add to the visual aspect of the design (19/10/22, [T-231/21](#), posts, ECLI:EU:T:2022:649, § 49-54).

General statements about the elegance or simplicity of the contested RCD that are not supported by objective evidence are likely to be inconclusive of other considerations that have played a role in the choice of the functional features (18/11/2020, [T-574/19](#), Fluid distribution equipment, EU:T:2020:543; 26/01/2022, [T-325/20](#), Water purifiers, EU:T:2022:23, § 59-61).

The success of a product on the market does not imply as such that considerations unrelated to functional needs were taken into account by the designer. The same conclusion applies to awards where the criteria for their adjudication do not relate solely to the design of the products at issue (18/11/2020, [T-574/19](#), Fluid distribution equipment, EU:T:2020:543, § 102).

#### 5.5.2.5 Modular systems

Given the overlap between Articles 8(1) and 8(2) CDR, Article 8(3) CDR is an exception applying to both grounds of functionality and interconnection.

The Office must examine if the design may benefit from the derogation applicable to modular systems, including where the request for invalidity was not based on Article 8(2) CDR, provided the RCD holder raised a defence based on Article 8(3) CDR in due course (24/03/2021, [T-515/19](#), Building blocks from a toy building set, EU:T:2021:155, § 69-80).

## 5.6 Designs of interconnections

Features of an RCD are excluded from protection if they must necessarily be reproduced in their exact form and dimensions in order to permit the product in which the design is incorporated or to which it is applied to be mechanically connected to, or placed in, around or against another product so that either product may perform its function. If Article 8(2) CDR applies to **all the essential features** of the RCD, the latter must be declared invalid (20/11/2007, ICD No 2 970).

It is up to the invalidity applicant to prove that an RCD may be objected to on the basis of Article 8(2) CDR. The applicant must substantiate the existence of the product whose form and dimensions dictate those of the RCD and submit facts, evidence and arguments demonstrating the interaction between the RCD and an existing product.

As an exception, Article 8(2) CDR does not apply to an RCD that serves the purpose of allowing the multiple assembly or connection of mutually interchangeable products within a modular system (Article 8(3) CDR). It is up to the holder to prove that the RCD serves such a purpose.

## 5.7 Lack of novelty and individual character

### 5.7.1 Disclosure of earlier design

#### 5.7.1.1 General principles

Challenging the validity of a Community design on account of its lack of novelty or individual character requires proof that the earlier design that is identical or that produces the same overall impression has been made available to the public before the date of filing of the application for registration or, if a priority is claimed, the date of priority (Article 7 CDR).

Disclosure of the earlier design is a preliminary step before deciding whether it is identical to the contested Community design or produces the same overall impression on the informed user (23/10/2018, [T-672/17](#), Cot bumpers, EU:T:2018:707, § 30). Therefore, if it is not proven that the earlier design has been disclosed, the application for declaration of invalidity will be rejected insofar as it is based on Articles 5 and 6 CDR.

Assessing disclosure of an earlier design requires a two-step analysis. Firstly, the invalidity applicant must prove the event of disclosure, that is, that the invoked earlier design has been published following registration or otherwise or exhibited, used in trade or otherwise disclosed (see [paragraph 5.7.1.2](#) below). Secondly, the holder of the contested Community design can claim that that event of disclosure should not be taken into consideration because either of the exceptions to disclosure provided in Article 7(1) CDR apply (see [paragraph 5.7.1.3](#) below) (14/03/2018, [T-651/16](#),

Footwear, EU:T:2018:137, § 48; 13/06/2019, [T-74/18](#), Informationstafeln für Fahrzeuge, EU:T:2019:417, § 24; 27/02/2020, [T-159/19](#), Furniture, EU:T:2020:77, § 20).

Therefore, the earlier design will be considered as disclosed when at least one event of its disclosure is established and provided that none of the exceptions contained in Article 7(1) CDR apply.

Nevertheless, a disclosure must not be taken into consideration if a design has been made available to the public during the ‘grace period’ by the designer, his or her successor in title or a third person as a result of information provided or action taken by the former, or as a consequence of an abuse in relation to the designer or his or her successor in title as provided in Article 7(2) and (3) CDR (see [paragraph 5.7.1.4](#) below).

### 5.7.1.2 Establishing the event of disclosure

For the purpose of establishing the event of disclosure the following aspects need to be taken into consideration.

#### 1. The source of the design’s disclosure

In general, a design can be disclosed anywhere in the world (13/02/2014, [C-479/12](#), “Athen” gazebo, EU:C:2014:75, § 33), including on the internet (see [paragraph 5.7.1.5](#)) and through various sources (e.g. by publishing in a catalogue, displaying in a trade fair, offering in an online store).

The evidence submitted must clearly identify the respective source of disclosure. It might also be important to submit any further information regarding that source, such as its purpose, targeted public, etc. (11/12/2019, [R 311/2019-3](#), Hookahs, § 23).

#### 2. The design invoked

The invoked earlier design should be identified and reproduced precisely and in its entirety (21/09/2017, [C-361/15 P](#) & [C-405/15 P](#), Shower drains, EU:C:2017:720, § 65).

The Office is not required to determine through assumptions and deductions which designs among those represented in the evidence may be relevant in respect of the invalidity application (see [paragraph 3.10.2](#)). Moreover, the relevant features of the earlier design should be clearly displayed in the evidence. Where the views of the earlier design submitted do not enable its comparison with the contested RCD, this does not amount to a disclosure for the purpose of Article 7(1) CDR (10/03/2008, [R 586/2007-3](#), Barbecues, § 22 et seq.).

For the purpose of Article 7 CDR, it is immaterial whether or not an earlier ‘design’ within the meaning of Article 3(a) CDR enjoys or enjoyed legal protection (as a design, trade mark, copyright work, patent, utility model or otherwise) (21/05/2015, [T-22/13](#) & [T-23/13](#), UMBRELLAS, EU:T:2015:310, § 24).



### 3. The date when the design was disclosed

When assessing disclosure of the earlier design, it is crucial to establish the date when it was made available to the public. That date must be prior to the date of filing of the application for registration of the contested RCD or, if a priority is claimed, the date of priority.

The date of disclosure is when a product to which a design is applied, or in which it is incorporated, was made publicly available and not when the circles specialised in the sector concerned actually became aware of this disclosure.

It is enough that the disclosure took place at a point in time that can be identified prior to the filing date or priority date of the contested RCD even if the exact date of disclosure is unknown (14/06/2011, [T-68/10](#), Watches, EU:T:2011:269, § 31-32; 13/06/2019, [T-74/18](#), Informationstafeln für Fahrzeuge, EU:T:2019:417, § 34).

Neither the CDR nor the CDIR provides for any specific form of evidence required for establishing the event of disclosure. Article 28(1)(b)(v) CDIR only states that 'documents proving the existence of those earlier designs' must be submitted. Nor are there any provisions as to any compulsory form of evidence that must be submitted. Article 65 CDR lists possible means of giving evidence before the Office, but it is clear from its wording that this list is not exhaustive ('shall include the following'). Accordingly, the evidence in support of the event of disclosure is a matter for the discretion of the applicant and, in principle, any evidence capable of proving the event could be accepted (13/06/2019, [T-74/18](#), Informationstafeln für Fahrzeuge, EU:T:2019:417, § 21; 27/02/2020, [T-159/19](#), Furniture, EU:T:2020:77, § 21).

The Office carries out an overall assessment of this evidence by taking all the relevant factors in the particular case into account. An event of disclosure cannot be proven by means of probabilities or suppositions, but must be demonstrated by solid and objective evidence of effective and sufficient disclosure of the earlier design (09/03/2012, [T-450/08](#), Phials, EU:T:2012:117, § 21-24; 13/06/2019, [T-74/18](#), Informationstafeln für Fahrzeuge, EU:T:2019:417, § 22).

A global examination of the items of evidence relating to the same earlier design implies that these items must be assessed in the light of each other. Even if some items of evidence are not conclusive in themselves, they may contribute to establishing the event of disclosure when examined in combination with other items (09/03/2012, [T-450/08](#), Phials, EU:T:2012:117, § 25, 30-45; 27/02/2018, [T-166/15](#), Sacs pour ordinateurs portables, EU:T:2018:100, § 24; 14/03/2018, [T-651/16](#), Footwear, EU:T:2018:137, § 52; 17/05/2018, [T-760/16](#), Fahrradkörbe, EU:T:2018:277, § 42, 45 and 50; 13/06/2019, [T-74/18](#), Informationstafeln für Fahrzeuge, EU:T:2019:417, § 22).

As regards 'statements in writing, sworn or affirmed', such as affidavits, as a matter of principle, they would not in themselves be sufficient to prove a fact such as the event of disclosure of an earlier design. They should be corroborated by additional evidence, in particular when they originate from the invalidity applicant itself or related persons (18/11/2015, [T-813/14](#), Cases for portable computers, EU:T:2015:868, § 29). In order to assess the evidential value of an affidavit, regard should be had first and foremost to



the credibility of the account it contains. It is then necessary to take account, in particular, of the person from whom the document originates, the circumstances in which it came into being, the person to whom it was addressed and whether, on the face of it, the document appears sound and reliable (09/03/2012, [T-450/08](#), Phials, EU:T:2012:117, § 39-40). The Office will apply the principles explained in the Guidelines, Part C, Opposition, Section 1, Opposition Proceedings, paragraph 5.3.2.3, Declarations.

In the absence of any indications to the contrary, the authenticity of the evidence submitted is assumed. The mere possibility of manipulating the relevant information is not enough to raise doubts as to its authenticity. Therefore, the evidence presented would only be rejected in cases of serious and substantiated doubt (27/02/2018, [T-166/15](#), Sacs pour ordinateurs portables, EU:T:2018:100, § 89-90; 27/02/2020, [T-159/19](#), Furniture, EU:T:2020:77, § 28-29).

#### Official publications

Publication of an earlier design in the bulletin of any intellectual property office worldwide constitutes an event of disclosure (21/05/2015, [T-22/13](#) & [T-23/13](#), UMBRELLAS, EU:T:2015:310, § 37). The same applies where the publication concerns the appearance of a product in relation to any other kind of intellectual property right, such as trade marks (16/12/2010, [T-513/09](#), Ornamentación, EU:T:2010:541, § 20) or patents (15/10/2015, [T-251/14](#), Doors (parts of), EU:T:2015:780, § 22).

However, a document kept by an intellectual property office, which is available to the public only by means of an application for inspection of files, may not be considered to have become known in the normal course of business to the specialised circles in the sector concerned and therefore would not give rise to a disclosure of an earlier design within the meaning of Article 7 CDR (22/03/2012, [R 1482/2009-3](#), INSULATION BLOCKS, § 39-43; 15/04/2013, [R 442/2011-3](#), Skirting boards, § 26).

In order to prove the event of disclosure, the evidence must allow the date of publication to be established independently of the date of filing or the date of registration. Whether or not the publication takes place before registration or after is irrelevant (15/04/2013, [R 442/2011-3](#), Skirting boards, § 24).

Moreover, the date of publication can be identified by the reference to the relevant INID code (internationally agreed numbers for the identification of (bibliographic) data).

#### Exhibitions

Exhibiting a design at a trade fair exhibition anywhere in the world generally constitutes an event of disclosure (14/03/2018, [T-651/16](#), Footwear, EU:T:2018:137, § 67).

Evidence from trade fairs must clearly depict the earlier design. It is also important to link the evidence to the particular event. A list of participants, a plan of stands or even contractual details with organisers may contribute to proving the design's disclosure.

#### Use in trade

Use in trade is another example given in Article 7(1) CDR of an event of disclosure, irrespective of whether such use is made within or outside the European Union (14/03/2018, [T-651/16](#), Footwear, EU:T:2018:137, § 68).

A design can be considered disclosed even when there is no proof that the products in which the earlier design is incorporated have actually been produced or put on the market (21/05/2015, [T-22/13](#) & [T-23/13](#), UMBRELLAS, EU:T:2015:310, § 36). It may be sufficient that the products were offered for sale in catalogues (22/10/2007, [R 1401/2006-3](#), ORNAMENTACIÓN, § 25), imported from a country outside the European Union (14/06/2011, [T-68/10](#), Watches, EU:T:2011:269, § 31-32) or were the object of an act of purchase between two European operators (09/03/2012, [T-450/08](#), Phials, EU:T:2012:117, § 30-45).

When submitting catalogues as evidence of disclosure, it is preferable that they be provided in their entirety. However, depending on the particular case it may be sufficient to submit only excerpts from their relevant parts (13/06/2019, [T-74/18](#), Informationstafeln für Fahrzeuge, EU:T:2019:417, § 35). Moreover, when combined or read in conjunction with other items of evidence, a catalogue can serve to establish disclosure even in the absence of evidence showing its distribution (27/02/2020, [T-159/19](#), Furniture, EU:T:2020:77, § 30-33).

### 5.7.1.3 Exceptions to disclosure

If the event of disclosure is duly established, there is a presumption that the earlier design has been disclosed within the meaning of Article 7(1) CDR (14/03/2018, [T-651/16](#), Footwear, EU:T:2018:137, § 47; 13/06/2019, [T-74/18](#), Informationstafeln für Fahrzeuge, EU:T:2019:417, § 23; 27/02/2020, [T-159/19](#), Furniture, EU:T:2020:77, § 41).

Nevertheless, the holder of the contested Community design can refute this presumption by proving that any of the exceptions to disclosure provided in Article 7(1) CDR apply in respect of that event of disclosure.

#### Designs deemed not to have been made available to the public

Following Article 7(1) CDR a design will be deemed to have been made available to the public, except where the event of disclosure could not reasonably have become known in the normal course of business to the circles specialised in the sector concerned operating within the European Union.

Therefore, the party challenging the disclosure must establish to the requisite legal standard, that the circumstances of the case could reasonably prevent the event of disclosure from becoming known to those specialised circles (15/10/2015, [T-251/14](#), Doors (parts of), EU:T:2015:780, § 26; 21/05/2015, [T-22/13](#) & [T-23/13](#), UMBRELLAS, EU:T:2015:310, § 26; 14/03/2018, [T-651/16](#), Footwear, EU:T:2018:137, § 47; 13/06/2019, [T-74/18](#), Informationstafeln für Fahrzeuge, EU:T:2019:417, § 23).

When there is more than one event of disclosure (e.g. a design has been presented in a trade fair and offered for sale in an online shop), the presumption would have to be rebutted in respect of them all.

The presumption set out in Article 7(1) CDR applies irrespective of where an event of disclosure took place. It is therefore not limited to the territory of the European Union (21/05/2015, [T-22/13](#) & [T-23/13](#), UMBRELLAS, EU:T:2015:310, § 27). The question

whether events of disclosure outside the European Union could reasonably have become known to persons forming part of those circles is a question of fact. The answer to that question has to be assessed on the basis of the particular circumstances of each individual case (13/02/2014, [C-479/12](#), “Athen” gazebo, EU:C:2014:75, § 34; 14/03/2018, [T-651/16](#), Footwear, EU:T:2018:137, § 55).

In the context of Article 7(1) CDR, what matters is whether the ‘circles specialised in the sector concerned’ have had an opportunity to have access to the design irrespective of the number that actually seized this opportunity and might have encountered the disclosed design. There is thus no quantitative threshold with regard to actual knowledge of the disclosure events (14/03/2018, [T-651/16](#), Footwear, EU:T:2018:137, § 73).

It must be examined whether, on the basis of the facts to be adduced by the party challenging the disclosure, it is appropriate to consider that it was not actually possible for those circles to be aware of the events constituting disclosure, whilst bearing in mind what can reasonably be required of those circles in terms of being aware of prior art. Those facts may concern, for example, the composition of the specialised circles, their qualifications, customs and behaviour, the scope of their activities, their presence at events where designs are presented, the characteristics of the design at issue, such as its interdependency with other products or sectors, and the characteristics of the products into which the design at issue has been integrated, including the degree of technicality of the products concerned. In any event, a design cannot be deemed to be known in the normal course of business if the circles specialised in the sector concerned can become aware of it only by chance (14/03/2018, [T-651/16](#), Footwear, EU:T:2018:137, § 56).

The ‘sector concerned’, within the meaning of Article 7(1) CDR, is not limited to that of the product in which the contested Community design is intended to be incorporated or applied (21/09/2017, [C-361/15 P](#) and [C-405/15 P](#), Shower drains, EU:C:2017:720, § 103). Moreover, Article 7(1) CDR lays down no restrictions relating to the nature of the activity of natural or legal persons who may be considered to form part of the ‘sector concerned’. Consequently, apart from persons involved in creating designs and developing or manufacturing products based on those designs within the sector concerned, traders may also form part of the ‘specialised circles’ within the meaning of Article 7(1) CDR (see, by analogy, 13/02/2014, [C-479/12](#), “Athen” gazebo, EU:C:2014:75, § 27).

#### Disclosure to a third person under explicit or implicit conditions of confidentiality

Making a Community design available to a third person under explicit or implicit conditions of confidentiality will not be deemed to constitute its disclosure (Article 7(1) CDR).

Therefore, disclosure of a design to a third party in the context of commercial negotiations is ineffective if the parties concerned agreed that the information exchanged should remain secret (20/06/2005, ICD No 172, § 22).

The burden of proving facts establishing confidentiality lies with the holder of the contested Community design (08/07/2020, [T-748/18](#), Pneumatic power tools, ECLI:EU:T:2020:321, § 25).

#### 5.7.1.4 Grace period

Article 7(2) CDR provides for a ‘grace period’ of 12 months preceding the date of filing or the priority date of the contested Community design. Disclosure of the Community design within such a period will not be taken into consideration if it was made by the designer or its successor in title.

As a matter of principle, the holder must establish that it is either the creator of the design upon which the application is based or the successor in title to that creator, failing which Article 7(2) CDR cannot apply (14/06/2011, [T-68/10](#), Watches, EU:T:2011:269, § 26-29).

Moreover, acts of disclosure made by a third person as a result of information provided or action taken by the designer or its successor in title are also covered by Article 7(2) CDR. This can occur, for instance, where a third party has made public a design copied from the design for which protection is sought because that was previously disclosed within the grace period by the holder itself (02/05/2011, [R 658/2010-3](#), LEUCHTVORRICHTUNGEN, § 37-39).

Article 7(2) CDR also provides for immunity against the loss of individual character pursuant to Article 6 CDR (02/05/2011, [R 658/2010-3](#), LEUCHTVORRICHTUNGEN, § 40). The exception provided in Article 7(2) CDR may therefore apply where the previously disclosed design is either identical to the contested Community design within the meaning of Article 5 CDR, or the previously disclosed design does not produce a different overall impression.

The ‘grace period’ also applies where the disclosure of a design is the result of an abuse in relation to the designer or its successor in title (Article 7(3) CDR). Whether the disclosure is the result of fraudulent or dishonest behaviour will be assessed on a case-by-case basis in the light of the facts, arguments and evidence submitted by the parties (25/07/2009, [R 552/2008-3](#), LECTEUR ENREGISTREUR MP3, § 24-27).

#### 5.7.1.5 Specificities of design disclosures on the internet

A growing number of design disclosures happen on the Internet. For this reason, the Office and a number of European Union intellectual property offices have agreed on a Common Practice ‘CP10 – Criteria for assessing disclosure of designs on the internet’.

The selected principles and recommendations set out in CP10 have been included in this section of the Guidelines. For further guidance, please consult the text of the Common Communication of CP10.

The following sections deal with the specificities of design disclosure on the internet.

##### Sources of disclosure on the internet

The internet provides for a number of possible sources for disclosure of a design.

Websites are among the most common sources of design disclosure on the internet, in particular those related to e-commerce and social media. Therefore, displaying a product on a website to which the design is applied or in which it is incorporated would generally constitute its disclosure.

Electronic mails can also qualify as sources of design disclosure, in particular those that aim to promote products and are sent to a large number of recipients (27/02/2018, [T-166/15](#), *Sacs pour ordinateurs portables*, EU:T:2018:100, § 93).

Further, designs can be disclosed through mobile applications, file sharing, etc.

#### Establishing the relevant date of disclosure on the internet

The information available on websites that is relevant for disclosure (e.g. articles, videos, product reviews, sale offers) usually displays the date when it was published.

However, the relevant date may not be visible in the contents of a website. Instead, only the date when a printout is made would be displayed, and this is normally later than the date of filing of the application of the contested Community design or its date of priority.

Nevertheless, various tools are available on the internet that could be used to retrieve historic information on the particular website, including the date of the disclosure of the design. For instance, website archiving services (such as the 'WayBack Machine') can provide access to archived websites or parts thereof showing a design on a particular date in the past. The date when a website was archived would be considered as the date of disclosure, unless an earlier relevant date appears in its contents.

When several dates are displayed in the evidence, it must be clearly indicated by the party concerned which is the relevant date of disclosure, that is, the date relied on to prove the event of disclosure.

In the case of electronic mails, the date when they have actually been sent would normally be displayed in their details and thus would appear in a printout.

#### Means for presenting the evidence obtained on the internet

Disclosure of a design on the internet can be established by submitting various types of evidence, such as printouts, screenshots, images, videos and metadata.

Merely providing a link to content on the internet (e.g. URL address of a website) is not sufficient. The Office will not perform a search for that content. Moreover, the content may have been altered or removed.

Printouts from websites, or their screenshots, are the most common means of proving the disclosure of designs on the internet, in particular, on e-commerce platforms, private company websites, social media and online databases.

For the purpose of proving disclosure, a printout or a screenshot should show the full URL address of a website, the date when the design was published and the disclosed design. Moreover, the information regarding the purpose and the main characteristics of the website could be relevant for assessing whether the design has been made available to the public.

When a printout or a screenshot does not include all the relevant elements, missing information may be shown by providing additional evidence (27/02/2018, [T-166/15](#), Sacs pour ordinateurs portables, EU:T:2018:100, § 61-63).

Moreover, user comments left on e-commerce platforms or in social media might also be relevant when assessing disclosure.

When submitting a printout of an electronic mail which contains the representation of a design as an attachment, the link between the printout of that electronic mail and the printout of the attachment should be proven.

Printouts and screenshots should not be modified manually, as this might have an effect on the credibility of this evidence (27/02/2018, [T-166/15](#), Sacs pour ordinateurs portables, EU:T:2018:100, § 90).

Additionally, a design might be disclosed by the publishing of photos and videos on the internet that show a product to which the design is applied or in which it is incorporated.

Photos should be complemented with the information regarding the source of disclosure and the relevant date.

In the case of videos, a disclosure of a design should preferably be proved by submitting one or several screenshots displaying the exact time when that design appears in the video.

Finally, when photos and videos are submitted as evidence, metadata extracted from digital cameras could be obtained for proving the date and the location the photo or video was taken.

#### Exceptions to the availability to the public

Taking the global nature of the internet into account, in general, online content is available worldwide.

However, due to some restrictions, in particular as to the accessibility or searchability of the information on the internet, it might be considered that an event of disclosure of a design online could not reasonably have become known to the circles specialised in the sector concerned operating within the European Union.

For instance, when assessing an event of disclosure related to the publication of a design on a website, it might be necessary to assess whether that website was technically accessible and the relevant circles were actually able to find the prior art on the internet (14/03/2018, [T-651/16](#), Footwear, EU:T:2018:137, § 61).

Unless the content is subject to restricted access in certain internal databases (e.g. used only by employees of a company), as a general rule, neither password nor payment requirements would be considered as precluding accessibility to the information published on the internet.



## 5.7.2 Assessment of novelty and individual character

A design will be protected as an RCD to the extent that it is new and has individual character (Article 4(1), Articles 5 and 6 CDR). The novelty and individual character of an RCD must be examined on its date of filing or, as the case may be, on its date of priority, in the light of the relevant earlier designs, which have been made available to the public pursuant to Article 7 CDR.

The RCD must be compared individually with each and every earlier design relied on by the applicant. Novelty and individual character of an RCD cannot be defeated by combining features taken in isolation and drawn from a number of earlier designs, but by one or more earlier designs, taken individually (21/09/2017, [C-361/15 P](#) and [C-405/15 P](#), Shower drains, EU:C:2017:720, § 69; 19/06/2014, [C-345/13](#), Karen Millen Fashions, EU:C:2014:2013, § 23-35; 22/06/2010, [T-153/08](#), Communications equipment, EU:T:2010:248, § 23-24).

A combination of already disclosed features is therefore eligible for protection as an RCD, provided the combination, as a whole, is novel and has individual character.

In principle, subject to a number of exceptions detailed below, all the features visible both in the representation of the contested design and in the earlier design, as disclosed, must be taken into consideration when examining novelty and individual character.

Nevertheless, in some circumstances, it remains possible to carry out a comparison on the basis of features of a design, which may be deduced from the compared design's representations themselves (29/04/2020, [T-73/19](#), Wood splitting tools, EU:T:2020:157, § 41). This can be the case where the compared designs represent products in different positions or stages of use or in different perspectives.

### Point of reference for the comparison

The contested RCD is the point of reference when assessing novelty and individual character in the comparison with the earlier design (13/06/2017, [T-9/15](#), Dosen [für Getränke], EU:T:2017:386, § 87).

Consequently, if the contested RCD is represented in only certain aspect views, for instance the front view, a comparison is only made with the corresponding part of the earlier design. Any additional features disclosed by the earlier design, such as those in its rear view, are disregarded.

The same principle applies when the contested RCD shows **fewer features** than the earlier design, such as, for example, when the contested RCD consists of the appearance of only part of a product whereas the earlier design discloses the whole product, or where the contested design is represented in black and white whereas the earlier design is represented in colour.

However, save for the exceptions outlined below, when the contested RCD shows **more features** than the earlier design, all of its features will be taken into account for the assessment of novelty and individual character. This can happen, for instance,

where the contested RCD includes colours, visible effects produced by textures or any other aspects of appearance that are not visible in the earlier design. In the assessment of the individual character, the relative importance given to such features is weighed in the context of the global assessment of the overall impression left by the compared designs (see [paragraph 5.7.2.2](#), subheading ‘The overall impression’).

#### Features dictated by a technical function and features of interconnection

Features that are solely dictated by a technical function and features that must necessarily be reproduced in their exact form and dimensions in order to allow interconnection with another product cannot contribute to the novelty and individual character of an RCD. A party alleging that individual features of the contested design are solely dictated by a technical function or by interconnecting purposes must submit facts, evidence and arguments in support of its claim (Article 8 CDR, see [paragraph 5.5.1](#)).

However, when features of a product serve a functional purpose without being solely dictated by the technical function within the meaning of Article 8 CDR, they may be relevant if it is established that they could be designed differently (10/11/2021, [T-443/20](#) Labels, EU:T:2021:767, § 95; 22/09/2021, [T-503/20](#), Signalling apparatus and devices, EU:T:2021:613, § 75-77). For instance, a button operating the functions on an electronic wristband can be placed on the product in different ways and can have different shapes and sizes (04/07/2017, [T-90/16](#), Measuring instruments, apparatus and devices, EU:T:2017:464, § 61). Any limitation to the freedom of the designer and effect on the assessment of the individual character of the contested design will be weighed in the context of the global assessment of the overall impression (see [paragraph 5.7.2.2](#) ‘The overall impression’).

#### Invisible features of component parts

Where the features of an RCD applied to a component part are only partially visible during normal use of the complex product, the comparison with the relevant earlier designs invoked must be limited to the visible parts (Article 4(2), see [paragraph 5.4](#)).

#### Clearly discernible features

Features of an RCD that are not clearly discernible in its graphical representation cannot contribute to its novelty or its individual character (Directive 98/71/EC of the European Parliament and of the Council of 13 October 1998 on the legal protection of designs, recital 11). Likewise, features of the earlier design that are not of sufficient quality to allow all the details to be discerned in the portrayal of the earlier design cannot be taken in consideration for the purpose of Articles 5 and 6 CDR (10/03/2008, [R 586/2007-3](#), Barbecues, § 23-26).

Features of an earlier design can be supplemented by additional features that were made available to the public in different ways, for instance, first, by the publication of a registration and, second, by the presentation to the public of a product incorporating the registered design in catalogues. However, these representations must relate to one and the same earlier design (22/06/2010, [T-153/08](#), Communications equipment, EU:T:2010:248, § 25-30).



### Disclaimed features

Features of a contested RCD that are disclaimed are disregarded for the purposes of comparing the designs. This applies to the features of a contested RCD represented with broken lines, blurring, colour shading or boundaries or in any other manner making clear that protection is not sought in respect of such features (14/06/2011, [T-68/10](#), Watches, EU:T:2011:269, § 59-64).

For further guidance, see [paragraph 5.4](#) (Use of visual disclaimers to exclude features from protection) in the Guidelines regarding [Examination of applications for registered Community designs](#) or consult the text of the Common Communication on Convergence on graphic representations of designs ([CP6](#)).

In contrast, disclaimed features of an earlier registered design can be taken into account when assessing the novelty and individual character of a contested RCD under Article 25(1)(b) CDR because the earlier design is considered as a disclosure irrespective of the subject matter of protection as an RCD, and thus includes even the disclaimed features.

#### 5.7.2.1 Novelty

A Community design will be considered to be new if it is not predated by an identical design disclosed pursuant to Article 7 CDR. Designs will be deemed to be identical if their features differ only in immaterial details (Article 5(2) CDR).



An earlier design incorporated in or applied to a product that is different from the one to which the later design relates is, in principle, relevant for the purposes of assessing novelty (21/09/2017, [C-361/15 P](#) & C-405/15 P, Shower drains, EU:C:2017:720, § 104; 15/01/2020, [R 2512/2018-3](#), Stickers, § 25).

There is identity between the Community design and an earlier design where the latter discloses each and every element constituting the former. A Community design cannot be new if it is included in a more complex earlier design (25/10/2011, [R 978/2010-3](#), PART OF SANITARY NAPKIN, § 20-21; 18/03/2020, [R 751/2019-3](#), Cube games, § 26).

However, the additional or differentiating features of the Community design may be relevant for deciding whether it is new, unless these elements are so insignificant that they may pass unnoticed.

An example of an immaterial detail is a slight variation in the shade of the colour pattern of the compared designs (28/07/2009, [R 921/2008-3](#), NAIL FILES, § 25; 20/01/2020, [R 2300/2018-3](#), Graphic symbols and logos, surface patterns, ornamentation, § 28-32).

Another illustration is the display, in one of the two compared designs, of a label that is so small in size that it is not perceived as a relevant feature (08/11/2006, [R 216/2005-3](#), CAFETERA, § 23-26), as in the following example.

Contested RCD No 5 269-0001 (view No 2)	Earlier design (invented example)
	

### 5.7.2.2 Individual character

A design will be considered to have individual character if the overall impression it produces on the informed user differs from the overall impression produced on such a user by any design that has been made available to the public before the date of filing of the application for registration or, if a priority is claimed, the date of priority (Article 6(1) CDR).

In assessing individual character, the degree of freedom of the designer in developing the design will be taken into consideration (Article 6(2) CDR).

It is apparent from these provisions that the assessment of the individual character of a registered Community design is the result, in essence, of a four-stage examination. This examination consists of **first** deciding upon the sector to which the products in which the design is intended to be incorporated or to which it is intended to be applied belong; **second**, the informed user of those products in accordance with their purpose and, with reference to that informed user, the degree of awareness of the prior art and the level of attention in the comparison, direct if possible, of the designs; **third**, the designer's degree of freedom in developing their design; and, **fourth**, the outcome of the comparison of the designs at issue, taking into account the sector in question, the designer's degree of freedom and the overall impressions produced on the informed user by the contested design and by any earlier design that has been made available to the public (10/09/2015, [T-525/13](#), Sacs à main, EU:T:2015:617, § 32; 13/06/2019, [T-74/18](#), Informationstafeln für Fahrzeuge, EU:T:2019:417, § 66).

The determination of the sector concerned, the informed user and the designer's degree of freedom, must be carried out only in relation to the contested design (10/11/2021, [T-193/20](#), Panels, EU:T:2021:782, § 24).

#### The products at issue

When defining the category of products concerned by the contested design, the relevant product indication in the registration of that design is considered as well as, where necessary, the contested design itself, insofar as it clarifies the nature of the

product, its intended purpose or its function (18/03/2010, [T-9/07](#), Metal rappers, EU:T:2010:96, § 56).

Therefore, the definition of the relevant category of products is primarily based on the product indication (see Examination of applications for registered Community designs, [paragraph 6.1.4](#)), but it may sometimes need to be better defined by referring to the design itself. It may be the case that the contested design is incorporated in a product which forms a self-contained category of homogenous products within the more general indication of products (15/10/2020, [T-818/19](#), Support pillows, EU:T:2020:486, § 31; 10/11/2021, [T-193/20](#), Panels, EU:T:2021:782, § 37-40).

The claim that the relevant products or the ‘sector concerned’ is limited to a very narrow segment of products for the use of particularly attentive users is unfounded when unsupported by the representation of the contested design itself (10/11/2021, [T-193/20](#), Panels, EU:T:2021:782, § 43).

The products actually marketed in which the designs at issue are incorporated can be taken into consideration only for illustrative purposes in order to determine the visual aspects of those designs. However, this consideration is only permitted on condition that the products actually marketed correspond to the contested design as registered. Therefore, a product that is actually marketed cannot be taken into account if the design incorporated in that product differs from the design as registered, or if it displays features that are not clearly apparent from the graphic representation of that design, as registered (10/11/2021, [T-193/20](#), Panels, EU:T:2021:782, § 33).

#### The informed user

The informed user is to be defined in relation to the relevant product in which the contested design is incorporated or to which it is applied (10/11/2021, [T-193/20](#), Panels, EU:T:2021:782, § 24).

The concept of ‘informed user’ refers to a fictitious person who routinely uses the categories of products in which the contested design is incorporated (21/09/2017, [C-361/15 P and C-405/15 P](#), Shower drains, EU:C:2017:720, § 125-126).

However, according to recital 14 CDR and the case-law, the informed user is aware of the existing design corpus, that is, any relevant design forming the state of the art, therefore, their knowledge is not limited to the sector related to the contested design. Furthermore, no actual knowledge of prior designs pertaining to products from different sectors has to be proved (21/09/2017, [C-361/15 P & C-405/15 P](#), Shower drains, EU:C:2017:720, § 121-134).

The status of ‘user’ implies that the person concerned uses the product in which the design is incorporated, in accordance with the purpose for which that product is intended (22/06/2010, [T-153/08](#), Communications equipment, EU:T:2010:248, § 46; 09/09/2011, [T-10/08](#), Internal combustion engine, EU:T:2011:446, § 24; 06/06/2013, [T-68/11](#), Watch-dials, EU:T:2013:298, § 58).

The concept of ‘informed user’ lies somewhere between that of the average consumer applicable in trade mark matters, who may not have any specific knowledge, and the sectorial expert, who has detailed technical expertise. Without being a designer or a

technical expert (and therefore without necessarily knowing which aspects of the product concerned are dictated by technical function, as found in 22/06/2010, [T-153/08](#), Communications equipment, EU:T:2010:248, § 48), the informed user is aware of the various designs that exist in the sector concerned and possesses a certain degree of knowledge with regard to the features that those designs normally include (20/10/2011, [C-281/10 P](#), Metal rappers, EU:C:2011:679, § 53, 59; 22/06/2010, [T-153/08](#), Communications equipment, EU:T:2010:248, § 47; 06/06/2013, [T-68/11](#), Watch-dials, EU:T:2013:298, § 59).

In other words, the informed user is neither a designer nor a technical expert. However, despite not necessarily knowing which aspects of a product are dictated by a technical function, they do have some awareness of the existing designs in the sector concerned.

The informed user is neither a manufacturer nor a seller of the products in which the designs at issue are intended to be incorporated (09/09/2011, [T-10/08](#), Internal combustion engine, EU:T:2011:446, § 25-27).

However, depending on the nature of the product in which the registered Community design is incorporated (e.g. promotional items), the concept of informed user may include a professional who acquires such products in order to distribute them to the final users, or the final users themselves (20/10/2011, [C-281/10 P](#), Metal rappers, EU:C:2011:679, § 54). The fact that one of these two types of informed users perceives the designs at issue as producing the same overall impression is sufficient for a finding that the contested design lacks individual character (14/06/2011, [T-68/10](#), Watches, EU:T:2011:269, § 56).

As a result of their interest in the products concerned, the informed user, as a rule, shows a relatively high degree of attention when using them (24/10/2019, [T-559/18](#), Medizinische Pflaster, EU:T:2019:758 § 50). Unlike the average consumer in the field of trade marks for whom the fact of being faced, for instance, with a fashion accessory may play a role in their level of attention, this fact is irrelevant when determining the level of attention of the informed user (21/05/2015, [T-22/13](#) & [T-23/13](#), UMBRELLAS, EU:T:2015:310, § 50). Likewise, the mere fact of being faced with a particular design with some frequency does not make the informed user more or less attentive, as the user's level of attention is already, by its very nature, very high (29/04/2020, [T-73/19](#), Wood splitting tools, EU:T:2020:157, § 75).

When the nature of the product in which the compared designs are incorporated makes it possible, the overall impression made by these designs will be assessed on the assumption that the informed user can make a direct comparison between them (18/10/2012, [C-101/11 P](#) & [C-102/11 P](#), Ornamentación, EU:C:2012:641, § 54-55).

#### The degree of freedom of the designer

The designer's degree of freedom depends on the nature and intended purpose of the product in which the contested design will be incorporated, as well as on the industrial sector to which the product belongs (see above).

The designer's degree of freedom in developing the design is established, inter alia, by the constraints of the features imposed by the technical function of the product or an

element thereof, or by statutory requirements applicable to the product. These constraints result in a standardisation of certain features, which will thus be common to the designs applied to the product concerned (13/11/2012, [T-83/11](#) & [T-84/11](#), Radiatori per riscaldamento, EU:T:2012:592, § 44).

In contrast, the designer's degree of freedom was not considered to be restricted in a number of cases (13/06/2019, [T-74/18](#), Informationstafeln für Fahrzeuge, EU:T:2019:417, § 79), in particular when the shape of the product into which the design is incorporated may vary considerably (21/11/2013, [T-337/12](#), Sacacorchos, EU:T:2013:601, § 36-39) and for instance come in any combination of colours, patterns, shapes and materials (05/07/2017, [T-306/16](#), Door handles, EU:T:2017:466, § 45-47). This may also be the case where the constraints of a functional nature concerning the presence of certain essential features are not liable to affect to a significant extent the form or overall appearance of the product, since they may take various forms and be arranged in various ways (13/06/2019, [T-74/18](#), Informationstafeln für Fahrzeuge, EU:T:2019:417, § 79; 04/07/2017, [T-90/16](#), Measuring instruments, apparatus and devices, EU:T:2017:464, § 61).

Furthermore, the designer's degree of freedom is not affected by the fact that similar designs coexist on the market and form a 'general trend' or coexist on the registers of industrial property offices (22/06/2010, [T-153/08](#), Communications equipment, EU:T:2010:248, § 58; 01/06/2012, [R 89/2011-3](#), Sacacorchos, § 27; 06/06/2019, [T-209/18](#), Kraftfahrzeuge / Kraftfahrzeuge, EU:T:2019:377, § 59).

The greater the designer's freedom in developing the challenged design, the less likely it is that minor differences between the designs at issue will be sufficient to make a different overall impression on an informed user. Conversely, the more the designer's freedom in developing the registered Community design is restricted, the more likely it is that minor differences between the designs at issue will be sufficient to make a different overall impression on the informed user (18/03/2010, [T-9/07](#), Metal rappers, EU:T:2010:96, § 67, 72). Therefore, if the designer enjoys a high degree of freedom in developing a design, this reinforces the conclusion that the designs that do not have significant differences make the same overall impression on an informed user (09/09/2011, [T-10/08](#), Internal combustion engine, EU:T:2011:446, § 33).

The degree of the designer's freedom is a mitigating factor which makes it possible to reinforce or, *a contrario*, moderate the conclusion as regards the overall impression produced by each design at issue (06/06/2019, [T-209/18](#), Kraftfahrzeuge / Kraftfahrzeuge, EU:T:2019:377, § 48).

Furthermore, the designer's degree of freedom may vary as regards the different features of a design, and this must be taken into account when assessing to what extent individual features contribute to the design's overall impression.

#### The overall impression

Under Article 6(1)(b) CDR, a registered Community design is to be considered to have individual character if the overall impression it produces on the informed user differs from the overall impression produced on such a user by any earlier design. In

assessing individual character, the degree of freedom of the designer in developing the design is to be taken into consideration (Article 6(2) CDR).

Unless the designs compared include functional, invisible or disclaimed features (see [paragraph 5.7.2](#)), the two designs must be compared globally. That does not mean, however, that the same weight should be given to all the features of the designs compared.

First, the informed user uses the product in which the design is incorporated, in accordance with the purpose for which that product is intended. The relative weight to give to the features of the designs compared may therefore depend on how that product is used. In particular, the role played by some features may be less important depending on their reduced visibility when the product is in use (22/06/2010, [T-153/08](#), Communications equipment, EU:T:2010:248, § 64-66, 72; 21/11/2013, [T-337/12](#), Sacacorchos, EU:T:2013:601, § 45-46; 21/05/2015, [T-22/13](#) & [T-23/13](#), UMBRELLAS, EU:T:2015:310, § 97).

Second, when appraising the overall impression conveyed by two designs, the informed user will only give minor importance to features that are totally banal and common to the type of product in question and will concentrate on features that are arbitrary or different from the norm (18/03/2010, [T-9/07](#), Metal rappers, EU:T:2010:96, § 77; 28/11/2006, [R 1310/2005-3](#), galletas, § 13; 30/07/2009, [R 1734/2008-3](#), FORCHETTE, § 26 et seq.).

Third, similarities relating to common features that are present in the design for functional or standardising purposes will have only minor importance in the overall impression produced by those designs on the informed user. In addition, the more the designer's freedom in developing the contested design is restricted, the more likely minor differences between the designs at issue will be sufficient to produce a different overall impression on the informed user (18/03/2010, [T-9/07](#), Metal rappers, EU:T:2010:96, § 72).

Fourth, the assessment of individual character (Article 6 CDR) follows a logic that is different from that underlying the exclusion of protection on account of functionality or interconnection (Article 8 CDR).

The fact that the earlier design is partly or wholly dictated by technical or interconnecting considerations is, as such, not decisive because Article 6 CDR does not require a comparison with an earlier valid design.

Where the contested design differs from or coincides with a prior design in **individual features**, which are solely dictated by technical or interconnecting considerations, a different or similar overall impression may be bestowed on the contested design by other arbitrary features or by the placement of those functional features or the features of interconnections.

The fact that the contested design differs from or coincides with a prior design in one or a number of features which, at least to some extent, are technical or have interconnecting purposes, will impact the comparison in two respects.



- Greater importance will in principle be given to other features whereby the designer made use of their freedom when developing the design, provided such features are apt to catch the informed user's attention on account of, for example, their size or position.
- The shape, configuration and placement of the functional or interconnecting features may also be considered (04/07/2017, [T-90/16](#), Measuring instruments, apparatus and devices, EU:T:2017:464, § 61) to the extent that the designer has some freedom in combining these elements. This degree of freedom can be evidenced by the existence of alternative shapes fulfilling the same function (09/09/2011, [T-10/08](#), Internal combustion engine, EU:T:2011:446, § 36).

Fifth, when familiar with a saturation of the prior art due to the density of the existing design corpus, the informed user may be more sensitive to even minor differences between the designs that may thus produce a different overall impression (13/11/2012, [T-83/11](#) & [T-84/11](#), Radiatori per riscaldamento, EU:T:2012:592, § 81; 12/03/2014, [T-315/12](#), Radiatori per riscaldamento, EU:T:2014:115, § 87). In order to prove the actual impact of this saturation on the informed user's perception, the holder of the contested RCD must present sufficient evidence of the existing design corpus and its density at the date of filing of the contested RCD or its priority date (10/10/2014, [R 1272/2013-3](#), RADIATORI PER RISCALDAMENTO, § 36, 47; 09/12/2014, [R 1643/2014-3](#), Radiatori per riscaldamento, § 51).

To illustrate, it was held that RCD No 1 512 633-0001 created a different overall impression from that produced by the earlier design (RCD No 52 113-0001). In an area in which the designer's degree of freedom in developing their design is not limited by any technical or legal restraints, the General Court (GC) upheld the decision of the Board of Appeal, which had found that the differentiating features of the two designs below prevailed over their common points. In particular, the fact that the armchair of the earlier design has a rectangular rather than a square shape, that its seat is placed lower and that the arms are broader, was considered decisive in support of the conclusion that the contested RCD had individual character (04/02/2014, [T-339/12](#), Armchairs, EU:T:2014:54, § 23-37).

According to the GC, account must be taken of the difference between the designs at issue as regards the angle of the backrest and the seat of the armchair represented in the contested design, bearing in mind that the overall impression produced on the informed user must necessarily be determined in the light of the manner in which the product in question is used. Since an inclined backrest and seat will give rise to a different level of comfort from that of a straight back and seat (albeit that comfort does not constitute a feature of appearance), the use that will be made of that armchair by the circumspect user is liable to be affected thereby (04/02/2014, [T-339/12](#), Armchairs, EU:T:2014:54, § 30).

<b>Contested RCD No 1 512 633-0001</b>	<b>Earlier RCD No 52 113-0001</b>
--	-----------------------------------

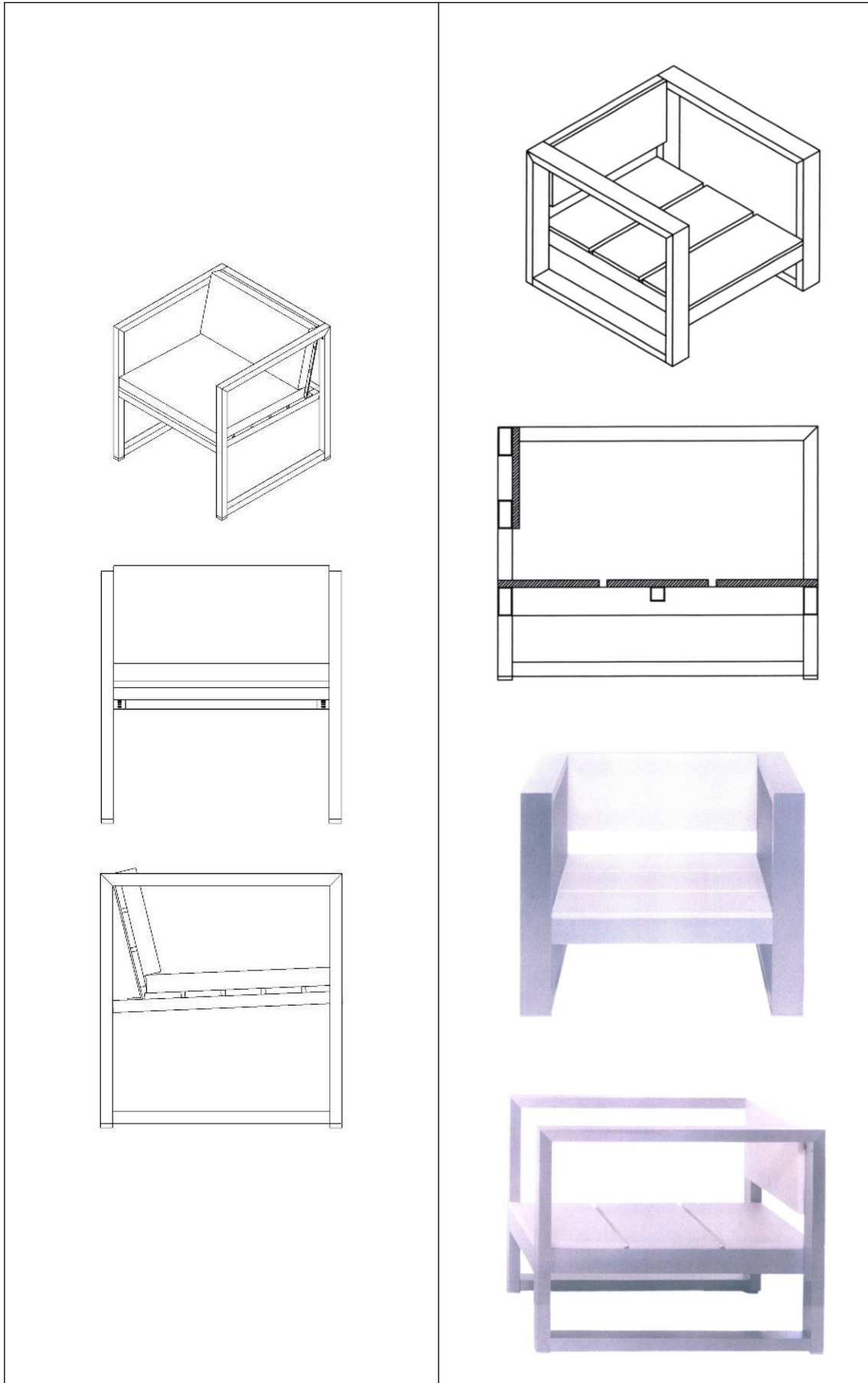



By contrast, the GC found that RCD No 1 512 633-0003 lacked individual character in respect of the same earlier design. It was held that the differentiating features between the designs, including the presence in the contested RCD of three cushions, were outweighed by their common characteristics (the rectangular shape, the flat back and seat, the seats positioned below the mid-section of the armchairs' structure, etc.) (04/02/2014, [T-339/12](#), Armchairs, EU:T:2014:54, § 44-60).

The GC confirmed the view taken by the Board of Appeal (27/04/2012, [R 969/2011-3](#), ARMCHAIRS) that the cushions are less important than the structure of the armchairs when assessing the overall impression caused by the designs because the cushions are not a fixed element but can be easily separated from the main product and because they are often sold and purchased separately, at a relatively low cost compared to that of the structure of an armchair. The informed user perceives the cushions as a mere optional accessory. They can hardly be considered to be 'a significant part of the design'. Consequently the overall impression produced by the designs at issue is dominated by the structure of the armchairs itself and not by the cushions, which could be regarded as secondary elements (04/02/2014, [T-339/12](#), Armchairs, EU:T:2014:54, § 37-38).

<b>Contested RCD No 1 512 633-0003</b>	<b>Earlier RCD No 52 113-0001</b>
--	-----------------------------------

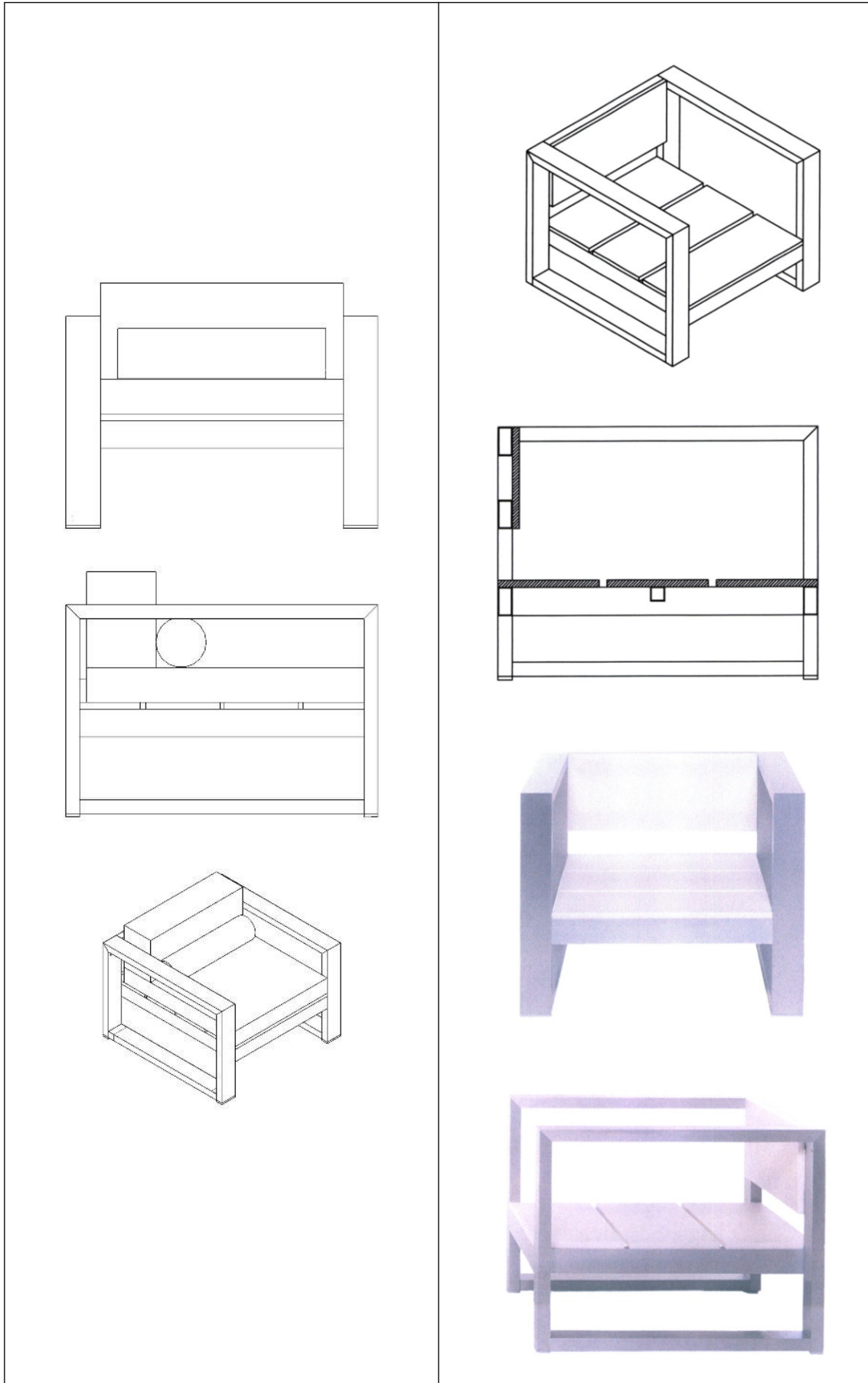

## 5.8 Conflict with a prior design right

Pursuant to Article 25(1)(d) CDR, a Community design will be declared invalid if it is in conflict with a prior design that has been made available to the public after the date of filing of the application or, if priority is claimed, the date of priority of the Community design, and which is protected from a date prior to that date:

1. by a registered Community design or an application for such a design; or
2. by a registered design right of a Member State or by an application for such a right; or
3. by a design right registered under the Geneva Act of the Hague Agreement concerning the international registration of industrial designs, adopted in Geneva on 2 July 1999, hereinafter referred to as 'the Geneva Act', which was approved by Council Decision 2006/954/EC and which has effect in the European Union, or by an application for such a right.

The purpose of Article 25(1)(d) CDR is to protect the holder of an earlier right that has not been made available to the public before the filing or priority date of the contested RCD and which, therefore, cannot be invoked as a prior design under Article 25(1)(b) CDR in conjunction with Articles 5 and 6 CDR.

Article 25(1)(d) CDR must be interpreted as meaning that a Community design is in conflict with a prior design when, taking into consideration the designer's freedom in developing the Community design, the design does not produce a different overall impression on the informed user from that produced by the prior design relied on (18/03/2010, [T-9/07](#), Metal rappers, EU:T:2010:96, § 52; 21/04/2021, [T-326/20](#); Beverage bottles, EU:T:2021:208, § 31).

When dealing with an application based on Article 25(1)(d) CDR, the Office will therefore apply the same test as for the assessment of individual character under Article 25(1)(b) CDR in conjunction with Article 6 CDR.

However, Article 25(1)(d) CDR is a relative ground for invalidity, where the contested RCD is to be assessed as possibly being in conflict with and falling within the scope of protection of another protected design right.

Therefore, pursuant to Article 25(1)(d) CDR, the features of the prior design right invoked must be appreciated within the limits of its scope of protection, as determined by its application or registration. This means that the prior design right is to be considered as applied for or as registered, excluding the features disclaimed, if applicable.

When an earlier national or international design on which the invalidity is based reaches the end of protection before the Office takes a decision on the matter, a communication is issued to the applicant in which it is invited to submit evidence of renewal. This is then communicated to the holder (05/05/2015, [T-715/13](#), Castello (fig.) / Castelló y Juan S.A. (fig.) et al., EU:T:2015:256, § 68 et seq.).

The Office will assume that the prior design remains valid in all other aspects unless the holder submits proof that a decision that has become final declared the prior design invalid before the adoption of the decision (see, by analogy, 29/03/2011, [C-96/09 P](#), Bud, EU:C:2011:189, § 94-95) (see [paragraph 4.1.6.2](#)).

## 5.9 Use of an earlier distinctive sign

A Community design will be declared invalid if a distinctive sign is used in a subsequent design, and the law of the European Union or the law of the Member State governing that sign confers on the holder of the sign the right to prohibit such use (Article 25(1)(e) CDR).

### 5.9.1 Distinctive sign and right to prohibit use

The notion of a ‘distinctive sign’ encompasses registered trade marks as well as all signs that can be relied on in the context of [Article 8\(4\) and 8\(6\) EUTMR](#).

In accordance with the practice under [Article 8\(4\) and 8\(6\) EUTMR](#), the applicant may also rely on provisions of national law on the prohibition of a later registration.

The applicant must establish only that it has a right to prohibit use of the subsequent Community design. It cannot be required to establish that such right has been exercised; in other words, that the applicant has actually been able to prohibit such use (see, by analogy, 29/03/2011, [C-96/09 P](#), Bud, EU:C:2011:189, § 191).

Where the earlier distinctive sign is a sign that can be relied on in the context of [Article 8\(4\) and 8\(6\) EUTMR](#), the Office will apply the corresponding law as explained in the Guidelines, Part C, Opposition, Section 4, Non-registered trade marks and other signs used in the course of trade (Article 8(4) EUTMR) and Part C, Opposition, Section 6, Geographical indications (Article 8(6) EUTMR).

### 5.9.2 Use in a subsequent design

The notion of ‘use in a subsequent design’ does not necessarily presuppose a full and detailed reproduction of the earlier distinctive sign in a subsequent Community design. Even though the Community design may lack certain features of the earlier distinctive sign or may have different additional features, this may constitute ‘use’ of that sign, particularly where the features omitted or added are of secondary importance and are unlikely to be noticed by the relevant public. It is enough that the Community design and the earlier distinctive sign be similar (12/05/2010, [T-148/08](#), Instruments for writing, EU:T:2010:190, § 50-52; 25/04/2013, [T-55/12](#), Cleaning devices, EU:T:2013:219, § 23; 09/08/11, [R 1838/2010-3](#), INSTRUMENTS FOR WRITING, § 43).

Where a Community design includes a distinctive sign without any disclaimer making clear that protection is not sought in respect of such feature, it will be considered that

the Community design makes use of the earlier distinctive sign even if the latter is represented in only one of the views (18/09/2007, [R 137/2007-3](#), Containers, § 20).

### **5.9.3 Substantiation of the application under Article 25(1)(e) CDR (earlier distinctive signs)**

Where an application for invalidity is based on a right held in an earlier European Union trade mark or an international trade mark designating the EU, it is not necessary to submit the law and case-law relating to European Union trade marks in order to substantiate such earlier right under [Article 9\(2\)\(a\)\(b\) or \(c\) EUTMR](#); the same applies if the applicant invokes an earlier national registered mark or an international trade mark designating a Member State.

Where the earlier distinctive sign is a sign that could be relied on in the context of [Article 8\(4\) and 8\(6\) EUTMR](#), an application must, pursuant to Article 28(1)(b)(vi) CDIR, contain particulars establishing the content of the EU or national law of which the applicant is seeking application including, where necessary, court decisions and/or academic writings (the principles established in the Guidelines, Part C, Opposition, Section 4, Non-registered trade marks and other signs used in the course of trade (Article 8(4) EUTMR) and Section 6, Geographical Indications (Article 8(6) EUTMR) will apply).

### **5.9.4 Examination by the Office**

The examination is carried out in accordance with the law governing the earlier distinctive sign.

Where the earlier distinctive sign is a European Union trade mark, the Office will apply the principles established in the Guidelines, Part C, Opposition, Section 2, Double Identity and Likelihood of Confusion, and Section 5, Trade Marks with Reputation.

Where the earlier distinctive sign is a registered national trade mark, the Office will apply the same principles (03/10/2017, [T-695/15](#), Comfit boxes, containers, EU:T:2017:684, § 29).

For the purpose of applying these principles, the Office will assume that the contested Community design or an element used in the contested design will be perceived by the relevant public as a sign capable of being used 'for' or 'in relation to' goods or services (12/05/2010, [T-148/08](#), Instruments for writing, EU:T:2010:190, § 107; 25/04/2013, [T-55/12](#), Cleaning devices, EU:T:2013:219, § 39 and 42).

The Office will examine for which goods the contested Community design is intended to be used (12/05/2010, [T-148/08](#), Instruments for writing, EU:T:2010:190, § 108). For the purpose of determining whether these goods and services are identical or similar, the Office will take into account the indication of the product(s) in which the design is intended to be incorporated or to which it is intended to be applied (Article 36(2) CDR), and also the design itself, insofar as it makes clear the nature of the product, its

intended purpose or its function (18/03/2010, [T-9/07](#), Metal rappers, EU:T:2010:96, § 56; 07/11/11, [R 1148/2010-3](#), PACKAGING, § 34-37).

Where the Community design is intended to be incorporated in two-dimensional 'logos', the Invalidity Division will consider that such logos may be applied to an infinite range of products and services, including the products and services in respect of which the earlier distinctive sign is protected (03/05/2007, [R 609/2006-3](#), logo MIDAS, § 27).

Where the earlier distinctive sign is a sign that could be relied on in the context of [Article 8\(4\) and 8\(6\) EUTMR](#), the Office will apply the corresponding law as explained in the Guidelines, Part C, Opposition, Section 4, Non-registered trade marks and other signs used in the course of trade (Article 8(4) EUTMR) and Part C, Opposition, Section 6, Geographical indications (Article 8(6) EUTMR).

## **5.10 Unauthorised use of a work protected under the copyright law of a Member State**

A Community design will be declared invalid if it constitutes unauthorised use of a work protected under the copyright law of a Member State (Article 25(1)(f) CDR).

### **5.10.1 Substantiation of the application under Article 25(1)(f) CDR (earlier copyright)**

Apart from the elements mentioned under [paragraphs 3.5](#) and [3.10.2](#) above, an application must, pursuant to Article 28(1)(b)(vi) CDIR contain:

- particulars establishing the content of the national law of which the applicant is seeking application including, where necessary, court decisions and/or academic writings (see, by analogy, 05/07/2011, [C-263/09 P](#), Elio Fiorucci, EU:C:2011:452; 23/10/2013, [T-566/11](#) & [T-567/11](#), Vajilla, EU:T:2013:549, § 52); and
- particulars showing that the applicant acquired the rights to the work protected under the copyright law relied on before the filing date or the priority date of the Community design (23/10/2013, [T-566/11](#) & [T-567/11](#), Vajilla, EU:T:2013:549, § 47); and
- particulars showing that the applicant satisfies the necessary conditions, in accordance with that law, to have the Community design invalidated or its use prohibited by virtue of its earlier right.

### **5.10.2 Examination by the Office**

The object of the examination is to ascertain whether the applicant for a declaration of invalidity is the holder of the copyright invoked and whether unauthorised use of a work protected by the copyright legislation of a Member State, as interpreted by the courts of that Member State, has occurred (23/10/2013, [T-566/11](#) & [T-567/11](#), Vajilla, EU:T:2013:549, § 52; 17/10/2013, [R 781/2012-3](#), CHILDREN'S CHAIRS, § 27, 43).

It should be noted that Article 25(1)(f) CDR does not apply to cases in which ownership of the Community design is contested, in particular when the invalidity applicant's essential argument is that the Community design was created not by the registered holder but by the invalidity applicant or by its employee. The Office has no jurisdiction to determine which of the parties is the rightful owner of the contested Community design since such jurisdiction lies with national courts (11/02/2008, [R 64/2007-3](#), Loudspeakers, § 18-19).

## **5.11 Improper use of flags and other symbols**

A Community design will be declared invalid if it constitutes an improper use of any of the items listed in Article 6*ter* of the Paris Convention, or of badges, emblems and escutcheons other than those covered by the said Article 6*ter* that are of particular public interest in a Member State (Article 25(1)(g) CDR).

The items covered by Article 6*ter* are the following (see the Guidelines, Part B, Examination, Section 4, Absolute Grounds for Refusal):

- armorial bearings, flags, other emblems, official signs and hallmarks that belong to states and have been communicated to WIPO, although, in the case of flags, such communication is not mandatory;
- armorial bearings, flags, other emblems, abbreviations and names of international intergovernmental organisations that have been communicated to WIPO, with the exception of those already the subject of international agreements for ensuring their protection (see, for example, the Geneva Convention for the Amelioration of the Condition of the Wounded and Sick in Armed Forces of 12/08/1949, Article 44 of which protects the emblems of the Red Cross on a white ground, the words 'Red Cross' or 'Geneva Cross', and analogous emblems).

Badges, emblems and escutcheons other than those covered by Article 6*ter* and which are of particular public interest in a Member State could include, for example, religious symbols, political symbols or symbols of public bodies or administrations such as provinces or municipalities.

### **5.11.1 Substantiation of the application under Article 25(1)(g) CDR (flags and other symbols)**

Apart from the requirements mentioned under paragraphs [3.5](#) and [3.10.2](#) above, when an item that is not listed in Article 6*ter* is invoked, the application must, pursuant to Article 28(1)(b)(vi) CDIR, show that such item is of particular public interest in a Member State.



### 5.11.2 Examination by the Office

The object of the examination is to ascertain whether the applicant for a declaration of invalidity is the person or entity affected by the use and whether the Community design constitutes an improper use of one of the symbols covered by Article 25(1)(g) CDR as listed above.

## 5.12 Partial invalidity

According to Article 25(6) CDR, a registered Community design that has been declared invalid pursuant to any of the grounds under Article 25(1)(b), (e), (f) or (g) CDR may be maintained in an amended form, if in that form it complies with the requirements for protection, and the identity of the design is retained.

A request for maintenance in an amended form of a registered Community design must be made by the holder before the end of the written procedure. The request must include the amended form. The proposed amended form may consist of an amended representation of the Community design from which some features are removed or which makes clear by means, *inter alia*, of broken lines that protection is not sought in respect of such features. The amended representation may include a partial disclaimer not exceeding 100 words (Article 25(6) CDR; Article 18(2) CDIR).

The applicant will be given an opportunity to comment on whether the Community design in its amended form complies with the requirements for protection and whether the identity of the design is retained (see [paragraph 4.1.4.1](#) above).

The identity of the Community design must be retained. Maintenance in an amended form will therefore be limited to cases in which the features removed or disclaimed do not contribute to the novelty or individual character of a Community design, in particular:

- where the Community design is incorporated in a product that constitutes a component part of a complex product, and the features removed or disclaimed are invisible during normal use of this complex product (Article 4(2) CDR); or
- where the features removed or disclaimed are dictated by a technical function or for the purposes of interconnection (Article 8(1) and (2) CDR); or
- where the features removed or disclaimed are so insignificant in view of their size or importance that they are likely to pass unnoticed.

The decision to maintain the Community design in an amended form will be included in the decision on the merits terminating the invalidity proceedings.



### **5.13 Grounds for invalidity that become applicable merely because of the accession of a new Member State**

See the Guidelines, [Examination of Applications for Registered Community Designs, paragraph 13, Enlargement and the Registered Community Design.](#)

## **6 Termination of the Proceedings**

### **6.1 Termination of proceedings without a decision on the merits**

The invalidity proceedings are terminated without a decision on the merits when:

1. the applicant withdraws its application as a result of an amicable settlement or otherwise; or
2. the holder surrenders the Community design in its entirety and the applicant did not request the Office to adopt a decision on the merits of the case (Article 24(2) CDR; see [paragraph 3.8](#) above); or
3. the contested Community design has lapsed and the applicant did not request the Office to adopt a decision on the merits of the case (Article 24(2) CDR; see [paragraph 3.8](#) above); or
4. the Office suspended a number of applications for a declaration of invalidity relating to the same registered Community design. These applications will be deemed to be disposed of once a decision declaring the invalidity of the Community design has become final (Article 32(3) CDIR).

The Office informs the parties that the proceedings are terminated without a decision on the merits.

### **6.2 Decision on costs**

#### **6.2.1 Cases where a decision on costs is taken**

If a decision on the merits of the case is taken, the decision on apportionment of costs is given at the end of the decision (Article 79(1) CDIR).

In all other cases, where the Office closes the case without a decision on the merits, a separate decision on costs is issued unless the parties have agreed on the costs as outlined below.

## **6.2.2 Cases where a decision on costs is not to be taken**

### **6.2.2.1 Agreement on costs**

Whenever the parties inform the Office that they have settled the invalidity proceedings with an agreement that includes the costs, the Office will not issue a decision on costs (Article 70(5) CDR). The Office will apply the principles explained in the Guidelines, Part C, Opposition, Section 1, Opposition proceedings, paragraph 6.5.2.1, Agreement on costs.

If no indication is given as to whether the parties have agreed on the costs, the Office will take a decision on costs at the same time as confirming the withdrawal of the application. If the parties inform the Office that they have reached an agreement on costs after the withdrawal of the application, the decision on costs already issued will not be revised by the Office. However, it is left to the parties to respect the agreement and not to enforce the Office's decision on costs.

### **6.2.2.2 Apportionment of costs**

The general rule is that the losing party, or the party that terminates the proceedings by surrendering the Community design, maintaining it in an amended form or withdrawing the application, must bear the fees incurred by the other party as well as all costs incurred by it essential to the proceedings (Article 70(1) and (3) CDR).

If both parties lose in part, a 'different apportionment' has to be decided (Article 70(2) CDR). As a general rule, it is equitable for each party to bear its own costs.

Where a number of applications for a declaration of invalidity relating to the same registered Community design have been suspended, they are deemed to be disposed of once a decision declaring the invalidity of the Community design has become final. Each applicant whose application is deemed to have been disposed of will bear its own costs (Article 70(4) CDR). In addition, the Office will refund 50 % of the invalidity fee (Article 32(4) CDIR).

### **6.2.2.3 Fixing of costs**

#### Recoverable costs regarding representation and fees

Where the costs are limited to representation costs and the application fee, the decision fixing the amount of costs will be included in the decision on the apportionment of the costs.

The amount which the winning party is entitled to claim is mentioned in Article 70(1) CDR and Article 79(6) and (7) CDIR.

As regards fees, the recoverable amount is limited to the invalidity fee of EUR 350 if the applicant wins.

As regards representation costs, the recoverable amount is limited to EUR 400. This applies both to the applicant and the holder insofar as represented in the invalidity proceedings by a professional representative within the meaning of Article 77 CDR. A winning party no longer represented by a professional representative at the time of taking a decision is also entitled to costs regardless of the stage of the proceedings when professional representation ceased. This is without prejudice to the need to appoint a professional representative where it is mandatory. The amount to be borne by the losing party is always fixed in euros, regardless of the currency in which the winning party had to pay its representative.

Representation costs for employees, even from another company with economic connections, are not recoverable.

#### Other recoverable costs

Where the costs include expenses in relation to an oral hearing or the taking of evidence, the registry of the Invalidity Division will, on request, fix the amount of costs to be paid (Article 70(6) CDR). A bill of costs, with supporting evidence, must be attached to the request for the fixing of costs (Article 79(3) CDIR).

The amount of recoverable costs may be reviewed by a decision of the Invalidity Division on a reasoned request filed within 1 month of the date of notification of the awarding of costs (Article 70(6) CDR; Article 79(4) CDIR).

#### Fixing of costs after remittance of the case to the Invalidity Division for further prosecution

When the invalidity decision has been annulled, wholly or partly, and the case is remitted by the Boards of Appeal, the situation will be the following:

- The first decision (which was appealed) does not become final, not even as regards apportionment or fixing of costs.
- As regards the costs of the invalidity proceedings, one single decision on the apportionment and on the fixing of costs must be taken for the invalidity procedure as a whole.
- As regards the costs of the appeal procedure, it has to be ascertained whether the Boards adjudicated on them. The notion of 'winning party' has to be applied to the outcome of the appeal proceedings, with the result that the decision can be different for the two instances. The amount of reimbursable representation costs for the appeal procedure is EUR 500, which applies in addition to the representation costs for the invalidity proceedings.

## 6.3 Correction of mistakes and entry in the Register

### 6.3.1 Correction of mistakes

In Invalidity Division decisions, only linguistic errors, errors of transcription and obvious mistakes may be corrected. They will be corrected by the Invalidity Division, acting of its own motion or at the request of an interested party (Article 39 CDR).

### 6.3.2 Entry in the Register

The date and content of the decision on the application or any other termination of proceedings will be entered in the Register once it is final (Article 53(3) CDR, Article 69(3)(q) CDR).

## 7 Other procedural issues

### 7.1 Change of parties

As regards the rules on **transfer and invalidity proceedings, change of name, change of representative and interruption of the proceedings due to death or legal incapacity of the applicant or its representative** in the course of invalidity proceedings, see the Guidelines, Part C, Opposition, Section 1, Opposition Proceedings, paragraph 7.5 Change of parties (transfer, change of name, change of representative, interruption of proceedings), as the rules are applicable *mutatis mutandis* to RCDs and RCD proceedings.

## 8 Appeal

### 8.1 Right to appeal

Any party to invalidity proceedings has the right to appeal against a decision that affects it adversely. A decision that does not terminate proceedings as regards one of the parties can only be appealed together with the final decision, unless the decision allows separate appeal. Any written communication of such a decision will include a notice that the decision may be appealed within 2 months from the date of receipt of the notification of the decision. Appeals have suspensive effect (Article 55 CDR).